

**NOT MEASUREMENT
SENSITIVE**

MIL-HDBK-57J (GS7)
21 SEPTEMBER 2022
SUPERSEDING
MIL-HDBK-57H (IS)
13 JULY 2017

DEPARTMENT OF DEFENSE HANDBOOK

LISTING OF FASTENER MANUFACTURER'S IDENTIFICATION SYMBOLS



This handbook is for guidance only. Do not cite this document as a requirement.

AMSC N/A

FSC 53GP

FOREWORD

1. This handbook is approved for use by the Defense Logistics Agency (DLA) Aviation and is available for use by all Departments and Agencies of the Department of Defense (DoD)
2. This issue contains the names, addresses, and the symbols of all fastener manufacturers whose identifying symbols were received on or before 21 September 2022.
3. This handbook was prepared by and is regularly updated through the cooperative efforts of Government and industry.
4. Copies of these documents are available online at <https://assist.dla.mil/>.
5. At the back of this handbook is a registration form. Manufacturers wishing to be listed must complete this form and return it to DLA Aviation. Submit the completed form, along with your fastener identification symbol artwork used on the fastener. All submittals must be in the English language.
6. All requests to be listed in the handbook should be addressed to:

Defense Supply Center Richmond (DSCR)
ATTN: DLA Aviation VEB Logo Registration
6090 Strathmore Road
Richmond, VA 23237
or e-mail to aviationlogo@dla.mil.
7. Please see <https://www.dla.mil/What-DLA-Offers/Consumable-Hardware/logoreg/> for more information regarding headmarking registration.
8. DLA Aviation does not “approve”, “rate”, or “endorse” any item, construction, proprietary device, or activity.
9. DLA Aviation is not responsible for the accuracy or completeness of the information contained in this publication.
10. DLA Aviation does not take any position with respect to the validity of any patent rights asserted in connection with any items mentioned in this document, and does not undertake to insure anyone utilizing a code, standard, or guide against liability for infringement of any applicable Letters Patent, nor assume any such liability. Users of code, standard, or guide are expressly advised that determination of the validity of any such patent rights, and the risk of infringement of such rights, is entirely their own responsibility.
11. DLA Aviation reserves the right to monitor this document to ensure that it contains the listing of only bona-fide fastener manufacturers.
12. DLA Aviation has solicited the assistance of the Defense Contract Management Agency (DCMA) and the Defense Management Command International (DCMCI) in an effort to identify non-manufacturers and remove them from the manufacturers’ listing. DCMA’s/DCMCI’s evaluation of a company’s status is based on an in house capability to manufacture fasteners (screws, bolts, studs and nuts), with respect to space, equipment, and trained personnel. On an on-going basis, any company identified by DCMA/DCMCI as a non-manufacturer will be removed from the manufacturers’ database and this handbook.
13. Comments, suggestions, or questions on this document should be addressed to Defense Supply Center Richmond (DSCR), ATTN: DLA Aviation VEB, 6090 Strathmore Road, Richmond VA 23237 or e-mail to aviationlogo@dla.mil. Since contact information can change, you may want to verify the currency of this address information using the ASSIST Online database at <https://assist.dla.mil>.

CONTENTS

PARAGRAPH	PAGE
FOREWORD.....	ii
1. SCOPE.....	-1-
1.1 Scope.....	-1-
2. APPLICABLE DOCUMENTS.....	-1-
3. DEFINITIONS.....	-1-
3.1 Acroyms.....	-1-
3.2 Definitions.....	-1-
4. GENERAL GUIDANCE.....	-1-
4.1 Format of Manufacturers List.....	-1-
5. DETAILED GUIDANCE.....	-2-
5.1 Manufacturers Listing.....	-2-
6. NOTES.....	-2-
6.1 Intended Use.....	-2-
6.2 Keyword Listing.....	-2-
6.3 Change from previous issue.....	-2-
INDEX A – MANUFACTURER.....	A-1
INDEX B – SYMBOL.....	B-1
APPENDIX A – DETAILED GUIDANCE LISTING.....	1
CONCLUDING MATERIALS.....	252
FIGURE	PAGE
1. SAMPLE LISTING ENTRY.....	-2-

1. SCOPE

1.1. Scope. This handbook provides a listing of identifying head markings of companies that have submitted their information. This handbook contains the names, addresses, and the symbols of all relevant fastener manufacturers. This handbook is for guidance only and cannot be cited as a requirement.

2. APPLICABLE DOCUMENTS This Section is not applicable to the handbook

3. ACRONYMS AND DEFINITIONS

3.1. Acronyms.

3.1.1. FSC. Federal Supply Class.

3.1.2. DLA. Defense Logistics Agency.

3.1.3. NSN. National Stock Number.

3.1.4. CAGE. Commercial and Government Entity.

3.2. Definitions.

3.2.1. Fasteners. Defined, for the purpose of this handbook, as those threaded items included in FSC 5305 – Screws, 5306 – Bolts, 5307 – Studs, and 5310 – Nuts.

3.2.2. Manufacturer. Defined, for the purpose of this handbook, as the source which substantially makes the supplies, either by hand or machinery out of raw materials.

3.2.3. Head Marking. A logo that is physically applied on a fastener, which is used to provide traceability to the manufacturer who made the fastener.

4. GENERAL GUIDANCE

4.1. Format of Manufacturers Listing. Listing of a manufacturer may include the following information:

- a. Company Name.
- b. Address.
- c. Identification Symbol.
- d. CAGE code

See FIGURE 1 for sample listing entry.

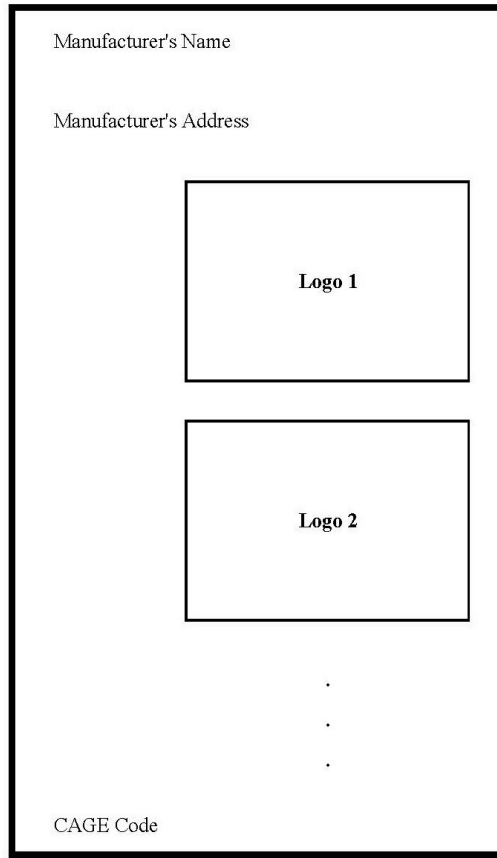

FIGURE 1. Sample listing entry

5. DETAILED GUIDANCE

5.1. Manufacturers Listing. Can be found in Appendix A.

5.1.1. See Index A for navigation of Appendix A sorted by manufacturer's name.

5.1.2. See Index B for navigation of Appendix A sorted by identification symbol.

6. NOTES

6.1. Intended use. This handbook provides guidance in the identification of head marking of fasteners to provide traceability of parts.

6.2. Key word listing.

Nut
Bolt
Screw
Marking

6.3. Changes from previous issue. Marginal notations are not used in this revision to identify changes with respect to the previous issue due to the extent of the changes.

MIL-HDBK-57J (GS7)
INDEX A

INDEX A – MANUFACTURER

3 V FASTENER COMPANY, INC. 1
3D MACHINE COMPANY, INC. 1
A & E MACHINED PRODUCTS 1
A & G ENGINEERING CO., INC. 1
A & M AEROSPACE, INC. 1
A & N PRECISION INDUSTRIES 1
A & R MFG COMPANY, INC. 1
A & S PIN PRODUCTS 1
A & W SCREW MACHINE PRODUCTS, INC. 2
A. AGRATI S.P.A. 2
A.G.H. INDUSTRIES, INC. 2
A.M.I ENGINEERING 2
A.P. MILLS INDUSTRIES FOR THE BLIND 2
A.S. AEROSPACE, INC. 2
A-1 NUT AND BOLT CO, INC 2
A-1 THREAD ROLLING CO. 3
AAP ACQUISITION CORP. 3
AASTRO ENGINEERING 3
ABBOTT INTERFAST CORP. 3
ABBOTT, PETER AEROSPACE LTD. 3
ABC TOOL AND DIE ENGINEERING &
MANUFACTURING LLC 3
ABRASIVE CUTTING CORP. 3
ABSCOA INDUSTRIES 4
ACCUFORM, INC. 4
ACCURA INDUSTRIES, INC. 4
ACCURATE AUTOMATIC PARTS CO. 4
ACCURATE PRECISION FASTENERS, INC. 4
ACCURATE SCREW MACHINE CO. 4
ACCURATE THREADED FASTENERS, INC. 4
DIVISION OF BEATRICE FOODS CO. 4
ACCURATE THREADED PRODUCTS CO. 5
ACCURATE TOOL CO., INC. 5
ACCU-TECH MANUFACTURING AND SUPPORT,
INC. 5
ACCUTOOL 5
ACCUTURN CORPORATION 5
ACE GRINDING & MFG. OF TEXAS 5
ACE PRECISION INDUSTRIES, INC. 5
ACHILLES AEROSPACE PRODUCTS, INC. 6
ACI 6
ACIMET MFG. 6
ACME INDUSTRIAL COMPANY 6
ACME MACHINE PRODUCTS 6
ACME RIVET & MACHINE CORP. 6
ACME SCREW COMPANY 6
ACRODYNE MFG CO. 6
ACUFAST AIRCRAFT PRODUCTS 7
ADAMS INDUSTRIES, INC. 7
ADAMS, EARL M. CO 7
ADC COMMUNICATIONS CORP. 7
ADI MANUFACTURING, INC. 7
ADJUSTABLE BUSHING CORP. 7
ADOM ENGINEERING 7
ADVANCE MACHINE WORKS, CORP. 7
ADVANCE PATTERN CORP. 8
ADVANCED CNC MANUFACTURING 8
ADVANCED MACHINING & FABRICATING, INC. 8
ADVANCED MACHINING & TOOLING, INC. 8
ADVANCED MANUFACTURING TECHNOLOGIES,
INC. 8
ADVANCED MACHINING TECHNOLOGIES 8
ADVANCED PLASTICS, INC. 8
AERCO RESEARCH 8
AERO & AUTO STUD SPEC 9
AERO BUSHING AND COMPONENT 9
AERO COMPONENTS CO. 9

AERO DYNAMIC MACHINING, INC. 9
AERO ENGINEERING AND MANUFACTURING CO.
OF CALIFORNIA 9
AERO MECHANICAL FASTENING SYSTEMS 9
AEROBOLT MANUFACTURING, INC. 9
AERO-FAB, INC. 10
AEROFAST SUPPLY 10
AEROMAX INDUSTRIES, INC. 10
AEROMED PRECISION, LLC 10
AEROSPACE MACHINE PRODUCTS 10
AEROSPACE MANUFACTURING 10
AEROSPACE MARINE SPECIALTY FASTENERS &
FITTINGS INC. 11
AEROSPACE PRODUCTS 11
AEROSPACE PRODUCTS CO. 11
AEROSPACE PRODUCTS, INC. 11
AEROSPACE RIVET MFG CORP 11
AEROSTAR ENGINEERING & MANUFACTURING
COMPANY 11
AEROSTAR FASTENER CORP. 11
AEROTECH FASTENERS, INC. 12
AEROWIND CORPORATION 12
AF FASTENERS LIMITED 12
AFAB PRECISION MACHINING 12
AFI INDUSTRIES, INC. 12
AIHARA SEIBYO CO LTD. 12
AIR INDUSTRIES CORPORATION 12
AIR LAND TURBINE SERVICES, INC. 13
AIR PARTS MFG. CO. 13
AIR-COM, INC. 13
AIRCRAFT ENGINEERING PRODUCTS, INC. 13
AIRCRAFT FUELSEAL FASTENERS, INC. 13
AIRDROME PARTS CO. 13
AIRFASCO, INC. 13
AIRFASCO INDUSTRIES FASTENER GROUP 14
AIRFRAME INTERNATIONAL, INC. 14
AIW-ALTON INC. 14
AJ ASSOCIATES MANUFACTURING &
ENGINEERING COMPANY, INC. 14
AKKO FASTENER, INC. 14
ALAN, JEFFREY, MFG. & ENGR. 14
ALARD MACHINE PRODUCTS 14
ALBAR MACHINE CORPORATION 15
ALCO MACHINE CO. 15
ALCOA FASTENING SYSTEMS & RINGS 15
ALCOA GLOBAL FASTENERS INC 15
ALEXANDER MANUFACTURING COMPANY INC. 15
see METRO TOOL & MANUFACTURING CO. 15
ALL AUTOMATICS 15
ALL MANUFACTURERS INC. 15
ALL PINS MANUFACTURING 16
ALLFAST FASTENING SYSTEMS, INC. 16
ALLIED NUT & BOLT CO., INC. 16
ALLIED PRECISION PRODUCTS, INC. 16
ALL-POWER MFG. CO. 16
ALL-PRO FASTENER & RIVET MFG. CO. 16
ALL-STATES INC. 16
ALLTECH INDUSTRIAL, LLC 17
ALPHA BOLT CO. 17
ALPHA FASTENERS COR. 17
ALPHA MACHINING PRODUCTS & DEVELOPMENT
..... 17
ALPINE MACHINE & TOOL CORP. 17
ALPS SEIKO CO. LTD. 18
AMACON CORP. 18
AMANDA BENT BOLT COMPANY 18
AMATOM ELECTRONIC HARDWARE 18
AME SWISS MACHINING LLC 18
AMERI-CUT SOLUTIONS 18
AMERICA AEROSPACE PRECISION MFG. 18

MIL-HDBK-57J (GS7)
INDEX A

AMERICAN AIRCRAFT PARTS MANUFACTURING COMPANY.....	19	ASAHI SREWS MANUFACTURING CO., LTD.....	28
AMERICAN ELECTRIC CONSTRUCTION MATERIALS GROUP.....	19	ASAI TEKKO CO. LTD.....	28
AMERICAN FASTENER & SPECIALTY CO.....	19	ASI DESIGN & MANUFACTURING, INC.....	28
AMERICAN INTERNATIONAL AERO MFG INC.....	19	ASL MANUFACTURING INC.....	28
AMERICAN METAL BEARING COMPANY.....	19	ASSOCIATED TOOL CO., INC.....	29
AMERICAN NUT MANUFACTURING.....	20	AST ASSOCIATES, INC.....	29
AMERICAN PRIDE FASTENERS, LLC.....	20	ATELIERS DE LA HAUTE-GARONNE (AHG).....	29
AMERICAN QUALITY MFG INC.....	20	ATF AEROSPACE.....	29
AMERIFAST CORP.....	20	ATF, INC.....	29
AMERITECH DIE & MOLD SOUTH INC.....	20	ATHENA INDUSTRIES.....	29
AMERITECH FASTENER MFG INC.....	20	ATLANTA ROD & MANUFACTURING.....	29
AMMAC, INC.....	21	ATLANTIC PRECISION SPRING INC.....	30
ANATASE PRODUCTS.....	21	ATLAS SPECIALTY PRODUCTS.....	30
ANCHOR BOLT & SCREW CO.....	21	ATOMATIC MANUFACTURING COMPANY.....	30
ANDERSON FORGE & MACHINE.....	21	AUGUST FRIEDBERG GMBH.....	30
ANDROCK HARDWARE CORPORATION.....	21	AUGUST FRIEDBERG GmbH.....	30
ANILLO INDUSTRIES, INC.....	21	AURORA DEFENSE GROUP.....	30
ANKIT FASTENERS PRIVATE LIMITED.....	21	AUTO BOLT CO.....	30
ANOTHER SCREW MACHINE PRODUCT.....	22	AUTOMATED MANUFACTURING.....	31
ANTRIM MACHINE PRODUCTS, INC.....	22	AUTOMATIC MACHINING AND MFG CO.....	31
A-ONE MACHINE COMPANY.....	22	AUTOMATIC SCREW MACHINE PRODUCTS COMPANY.....	31
APEL LTD.....	22	AUTO SCREW, INC.....	31
APEX MFG. CO. INC.....	22	AUTO-VALVE, INC.....	31
APHEONIX CORPORATION.....	22	AVDEL INTERNATIONAL (AVDEL LTD).....	31
ARCHER SCREW PRODUCTS.....	22	AVIATION MANUFACTURING GROUP LLC.....	32
ARCO SALES CO.....	23	AVIBANK MANUFACTURING, INC.....	32
ARCONIC FASTENING SYSTEMS & RINGS.....	23	AVK INDUSTRIES PRODUCTS INC.....	32
CARSON OPERATIONS.....	23	AXIAL GLOBAL LLC.....	32
CITY OF INDUSTRY OPERATIONS.....	23	AZAD ENGINEERING PVT LTD.....	32
FREE ZONE MIDPARC.....	23	AZTECH ENGINEERING, INC.....	33
FULLERTON OPERATIONS PLANT 1.....	23	AZTECH LOCKNUT COMPANY.....	33
HILDESHEIM OPERATIONS.....	23	B & B ELECTRO-MECHANICAL.....	33
(Continued).....	24	B & B SPECIALTIES INC.....	33
KELKHEIM OPERATIONS.....	24	B & D THREADED ROLLING INC.....	33
LEICESTER OPERATIONS.....	24	B & E MACHINE SHOP & SHEET METAL FAB., INC.....	33
NEMESVAMOS OPERATIONS.....	24	B & E MANUFACTURING CO., INC.....	33
NEWBURY PARK OPERATIONS.....	24	B & G MANUFACTURING CO., INC.....	34
REDDITCH OPERATIONS.....	24	B & N TOOL CO.,INC.....	34
ST. COSME OPERATIONS.....	24	B & R MACHINE AND TOOL CORP.....	34
SYLMAR OPERATIONS.....	24	B F GOODRICH CO. RIVNUT ENGINEERED FASTENERS.....	34
(Continued).....	24	B G ENGINEERING, INC.....	34
TORRANCE OPERATIONS.....	25	B G M FASTENER CO., INC.....	34
TOULOUSE OPERATIONS.....	25	B. V. FABRIEK VAN KLINKNAGELS EN SCHROEFBOUTEN V/H SMIT.....	35
TUCSON OPERATIONS.....	25	BARCO ENGINEERING COMPANY, INC.....	35
US OPERATIONS.....	25	BARNEGAT BAY NSCC, INC.....	35
WACO OPERATIONS.....	25	BARRE PRECISION PRODUCTS INC.....	35
ARDOR MFG. INC.....	25	BAS AEROSPACE LIMITED.....	35
ARGARWAL INDUSTRIES.....	26	BAUER & SCHAURTE KARCHER GMBH.....	35
ARJAY PRECISION, INC.....	26	BAY BOLT.....	35
ARMSTRONG ATLAS BOLT.....	26	BAY SWISS MANUFACTURING.....	36
ARMSTRONG PRECISION COMPONENTS LTD.....	27	BBC FASTENERS, INC.....	36
ARNOLD KNIPPING GmbH.....	27	BEACH MACHINE.....	36
ARNOLD UMFORMTECHNIK.....	27	BEAVER PRODUCTS CORP.....	36
GMBH & CO. KG.....	27	BEC MACHINE PRODUCTS.....	36
ARNOLD WRAGG (BOLTS & NUTS) LTD.....	27	BEE INDUSTRIES, INC.....	37
ARROW SCREW & MACHINE WORKS.....	27	BEGONIA TOOL COMPANY.....	37
ARTISAN SPECIALIST TECH.....	28	BEK, INC.....	37
ARVAN, INC.....	28	BEK LEVEL 1 FASTENERS.....	38
		BEL-AIR MACHINE & PERFORMANCE.....	38
		BELL FASTENERS.....	38
		BELL-MEMPHIS, INC.....	39
		BELL PRECISION, INC.....	39
		BEN YUAN ENTERPRISE CO, LTD.....	39
		BENACO TOOLING R AND D CORP.....	39
		BEOTool CORP.....	39
		BERGNER, RICHARD GMBH & CO. KG.....	39
		BER-LOW MFG INC.....	40
		BERRY MANUFACTURING.....	40

MIL-HDBK-57J (GS7)
INDEX A

BETA CORP.....	40	CAMCAR DIVISION OF TEXTRON INC.....	52
BETA ENGINEERING, INC.....	40	TAPTITE PRODUCTS.....	52
BIG BOLT CORP.....	40	CAMCAR DIVISION OF TEXTRON INC.....	52
BIRANT MAKINA LTD STI.....	40	TORX PRODUCTS.....	52
BISHOP ENTERPRISES, INC.....	40	CAMCAR LLC.....	53
BLAINE TOOL CORP.....	41	CAMCAR SCREW AND MFG CO DIV OF TEXTRON	
BLANC AERO INDUSTRIES.....	41	INC.....	53
BLANC AIRCRAFT FASTENERS, INC.....	41	CAMLOC FASTENER CORPORATION.....	53
BLAND CO., THE.....	41	CAMLOC GmbH.....	53
BLUE TEE CORP DBA GEFCO.....	41	CAM-TECH INDUSTRIES.....	53
BOBCAT MANUFACTURING CO. (PLANT).....	42	CANADY MANUFACTURING CO. INC.....	53
BOGNER ENGINEERING CO.....	42	CAPRICE ENGINEERING CO., INC.....	54
BOLLHOFF & CO. GmbH & CO. KG.....	42	CAPY MACHINE SHOP, INC.....	54
BOLT & NUT CO.....	42	CARDINAL FASTENER & SPECIALTY CO., INC.....	54
BOLT FASTENER STUD/TECHNOLOGY.....	42	CARDINAL INDUSTRIAL PRODUCTS.....	54
BOLTWORKS, INC.....	42	CARDINAL MACHINING SERVICES LLC.....	54
BOMAR ENGINEERING, INC.....	43	CARR CO.....	54
BOMBSHELL, INC.....	43	CATALINA INSTRUMENT CORPORATION.....	55
BONEAL INC.....	43	CAVALIER BOLT & NUT, INC.....	55
BRACELENTE MANUFACTURING CO., INC.....	43	CBS FASTENERS INC.....	55
BRADY MACHINE, INC.....	43	CCB INDUSTRIES, INC.....	55
BRANCH MACHINE PARTS, INC.....	43	CCF ENTERPRISES INC.....	55
BRIARWOOD FASTENERS, INC.....	43	CDS MACHINE INC.....	55
BRIDEAN MACHINE & TOOL CO., INC.....	43	CEI INC.....	55
BRIDGEVIEW MANUFACTURING CO.....	44	CELTECH ENTERPRISE.....	56
BRIGHT LIGHTS USA, INC.....	44	CEN TEX DEFENSE INDUSTRIES.....	56
BRILES AEROSPACE, INC.....	44	CENTENNIAL BOLT, INC.....	56
BRINTCLIFFE TURNER LTD.....	44	CENTERLINE TOOL & ENGINEERING, INC.....	56
BRISTOL INDUSTRIES.....	44	CENTRAL OZARK MACHINE, INC.....	57
BRISTOL LOCKNUT CO.....	44	CENTRAL SCREW PRODUCTS.....	57
BROADSTONE TOOL & DIE, INC.....	45	CENTRIX, INC.....	57
BROADWAY SCREW MACHINE INC.....	45	CENTURY METAL PARTS CORP.....	57
BROWN PRODUCTION, INC.....	45	CEREBRUS CORPORATION.....	58
BRUNNER DRILLING & MFG. CO., INC.....	45	CERNY MFG. CO.....	58
BRUNNER MANUFACTURING CO.....	46	CETIN CIVATA SANAYI VE TICARET A.S.....	58
BRYCO MACHINE, INC.....	46	CHAMPION COMMERCIAL INDUSTRIES, INC.....	58
BRYNOLF MANUFACTURING, INC.....	46	CHAMPION FASTENERS, INC.....	58
BUCK EYE FORGE, INC.....	46	CHANCE, A.B. COMPANY.....	58
BUCKEYE MACHINING, INC.....	46	CHANDLER PRODUCTS, INC.....	58
BUFFALO PUMPS, INC.....	46	CHATHAM PRECISION, INC.....	59
BULA FORGE INC.....	47	CHEMIQUIP PRODUCTS COMPANY.....	59
BULTEN TRADING AB.....	47	CHEREK MACHINE & TOOL CO., INC.....	59
BURROWERS RESEARCH MACHINING, INC.....	47	CHEROKEE TOOL & ENGINEERING CO., INC.....	59
BUSAN INDUSTRIAL MACHINERY CO., LTD.....	47	CHIANG SHIN FASTENERS INDUSTRIES, LTD.....	59
BUTECH PRESSURE SYSTEMS.....	47	CHICAGO FASTENER MANUFACTURING.....	59
BUTLER, INC.....	48	CHICAGO HARDWARE & FIXTURE CO.....	59
C & A MACHINE CO.....	48	CHICAGO NUT & BOLT INC.....	59
C & D MACHINE TOLL, INC.....	48	CHIEF MFG.....	60
C & H MFG., INC.....	48	CHOICE PRECISION MACHINE, INC.....	60
C & S ENGINEERING LLC.....	48	CHRIS MACHINE CO.....	60
C. E. MACHINE CO., INC.....	48	CHU HUA INDUSTRIAL CO., LTD.....	60
C.E.S. MACHINE PRODUCTS, INC.....	48	CHUN YU WORKS & CO., LTD.....	60
C.G.I. FASTENERS INC.....	48	CINCH MANUFACTURING.....	60
C. J.'S GENERAL MACHINE WORKS.....	49	CLEVELAND HARDWARE & FORGING.....	60
C.R.D. MACHINING.....	49	DBA GREEN BAY DROP FORGE.....	60
CALABRESE & SONS, INC.....	49	CLICK BOND, INC.....	60
CALIFORNIA SCREW PRODUCTS CORP.....	49	CLYDE FASTENERS LIMITED.....	61
CAMBRIDGE SPECIALTY COMPANY, INC.....	50	CM MANUFACTURING, INC.....	61
CAMCAR DIVISION OF TEXTRON INC.....	50	CMTECHTOOLS, LLC.....	61
AMSCO PRODUCTS.....	50	CNC MACHINING INC.....	61
CAMCAR DIVISION OF TEXTRON INC.....	50	COAE BOLTS WORKS CO., LTD.....	61
DRILLETITE PRODUCTS.....	50	COAST INDUSTRIAL SUPPLY CO., INC.....	61
CAMCAR DIVISION OF TEXTRON INC.....	51	CODLING TOOL & MFG. INC.....	61
RAYCARL PRODUCTS.....	51	COLD HEADING CO., THE.....	62
ROCKFORD HEADED PRODUCTS.....	51	COLOC MANUFACTURING DIVISION INGRAM	
CAMCAR DIVISION OF TEXTRON INC.....	51	INDUSTRIES, INC.....	62
SEMS PRODUCTS.....	51	COLSAX LLC.....	62
SOCKET SCREW PRODUCTS.....	51	COLTEC INDUSTRIES, INC.....	62
		DBA FAIRBANKS MORSE ENGINE.....	62

MIL-HDBK-57J (GS7)
INDEX A

COMET MFG. CO., INC.	62	DIAL SUPPLY AND MFG., INC.	72
COMMAND ENTERPRISES.....	62	DIESEL PARTS COMPANY OF CALIFORNIA.....	72
COMPONENT PRODUCTS CORPORATION	62	DIHARD COMPANY.....	72
COMPUTA-BASE MACHINING, INC.	63	DILLON AERO, INC.	72
CONNECTICUT AIRCRAFT PRODUCTS.....	63	DISC-LOCK INTERNATIONAL	72
CONTINENTAL MACHINE PRODUCTS, INC.	63	DIVERSIFIED FASTENING SYSTEMS, INC.	72
CONTINENTAL TOOL & MANUFACTURING.....	63	DIXON MACHINE & TOOL	73
CONTRACTING CNC MACHINING	63	DBA DIXON MACH AND FABRICATION	73
CONQUEST MACHINE, INC.....	63	DO MANUFACTURING CORP.	73
CO-OP SCREW MANUFACTURING CORP.	63	DO-ALL PRECISION, INC.....	73
COOPER POWER SYSTEMS INC	63	DOMESTIC FASTENER & FORGE, INC.....	73
MCGRAW EDISON POWER SYSTEMS.....	63	DOMESTIC FORGING, INC.....	73
COPA TOOL, LLC	64	DONSON MACHINE	73
COPELAND MFG. CORP.....	64	DOUBLECO INCORPORATED	74
COPPER STATE BOLT & NUT CO.....	64	DBA R & D FASTENERS	74
CORPUS CHRISTI GASKET & FASTENER LTD.	64	DOUGLASS TOOL & ENGINEERING CO., INC.	74
CREATIVE PRECISION INC.....	64	DRESSER INDUSTRIES, INC.	74
DBA CREATIVE PRECISION WEST	64	DRESSER PUMP DIVISION	74
CRESCENT MANUFACTURING CO.	64	D'SAMIC	74
CRS PRECISION CORP.	65	DTF MANUFACTURING, INC.....	74
CRUM MFG.	65	DIV OF FEDERAL SCREW AND SUPPLY CO.	74
CRYSTAL METAL PRODUCTS COMPANY, INC.....	65	DUFFY ELECTRONICS & MFG. CO.	75
CSM FASTENER PRODUCTS.....	65	DUNCAN ELECTRONICS & MFG. CO.	75
CUMMINS AEROSPACE	65	DUNHAM PRODUCTS, INC.	75
DBA YEAGER MANUFACTURING CORP.....	65	DUPONT, G.B. CO., INC.....	75
CURTIS PRESTON ENTERPRISES INC.	65	see G.B. DUPONT CO., INC.....	75
DBA ATLAS SPECIALTY PRODUCTS	65	DUSEVOIR METAL PRODUCTS, INC.	75
CUTTING EDGE ENTERPRISE, LLC	66	DUVE GmbH & CO. KG	75
CUTTING EDGE MACHINING INC.....	66	DYNACAST	75
CUTTING EDGE MACHINING SOLUTIONS, INC.	66	INDUSTRIAL FASTENERS DIVISION	75
CWR MANUFACTURING CO	66	DYNAMIC ENGINEERING.....	76
DIVISION OF A.J. MUPHY CO., INC.	66	DYSON CORP THE	76
D & D MACHINERY AND SALES.....	66	DZUS FASTENER CO., INC.	76
D & D MANUFACTURING	66	E. KOZAK PRECISION PRODUCTS CO.....	76
D & D TOOL COMPANY, INC.	66	E.L.R. MACHINE AND TOOL.....	76
D & R MACHINE COMPANY.....	67	EAGAN MACHINE CORP.....	76
D. C. MACHINING INC.	67	EAGLE PICHER INDUSTRIES.....	76
DDM SUPPLY LLC	67	EAGLEHEAD MANUFACTURING COMPANY	77
D.S.O. PLASTICS, INC.....	67	DBA DEJAK MACHINE TOOL COMPANY DIV	
DABS M&A, LLC	67	DEJAK DRILLING	77
DACK INDUSTRIES, IN.....	67	EAST BAY MANUFACTURERS INC.	77
DANIEL CO., EDWARD W.	68	EAST COAST METALS INC.	77
DAN-LOC BOLT & GASKET INC.	68	EASTERN SCREW CO., INC.....	77
DARCO PRODUCTS.....	68	EASTWOOD MFG., CO.	77
DAVE ALLEN ENTERPRISES	68	EATON AEROQUIP CORPORATION	77
DAVIES PRECISION MACHINING, INC.	68	AEROSPACE DIVISION	77
DAVIS AIRCRAFT PRODUCT CO., INC.....	68	EBC INDUSTRIES	77
DAYMAK SU DEPOSU IMLAT MAKINA INSAAT		EBERHARD BRUNINGHAUS.....	78
TAHHUT TURIZM GIDA VE DIS TIC. LTD. STI.	69	ECENARRO S. COOP. LTDA.....	78
DECKER MANUFACTURING CORP	69	EDS ORDNANCE.....	78
DEERE & CO.....	70	ELASTIC STOP NUT	78
DEFENSE AEROSPACE.....	70	DIVISION OF HARVARD INDUSTRIES, INC.	78
DEFENSE QUALITY MFG.....	70	ELCO INDUSTRIES, INC.....	78
DEFIANCE STAMPING COMPANY, THE.....	70	ELECTRO-FREETO MANUFACTURING COMPANY	79
DEHOUSSE (USINES).....	70	ELEIT TECHNOLOGY, INC.	79
DELL MFG. CO., INC.	70	ELGIN FASTENER GROUP LLC.....	79
DELT INDUSTRIES, INC.....	70	CHANDLER PRODUCTS.....	79
AEROSPACE PRODUCTS DIVISION.....	70	QUALITY BOLT & SCREW	79
DELTA MACHINE & TOOL CO., INC.	71	TELEFAST INDUSTRIES.....	79
DEL-VAL FASTENER MANUFACTURING	71	ELITE FASTENERS	79
DEMAT	71	ELLIS PRECISION INDUSTRIES	80
DEPENDABLE MACHINE CO., INC.	71	DBA E P IND.	80
DERBYSHIRE MACHINE & TOOL CO.	71	EMERALD VALLEY MFG.....	80
DBA DERBYSHIRE MARINE PRODUCTS	71	EMHART CORP.....	80
DETROIT HEADING CO.	71		
DEUTSCH FASTENER CORPORATION.....	71		
DFCI SOLUTIONS, INC.....	72		
DHL ENTERPRISES	72		

MIL-HDBK-57J (GS7)
INDEX A

PARKER-KALON DIVISION	80	FERNDALE FASTENER.....	91
GRIPCO FASTENER DIVISION.....	80	FERRIERE DI STABIO, S.A.....	91
EMP MANUFACTURING CO.....	81	FERRY CAP & SET SCREW CO., THE	91
EMPIRE PRECISION MACHINING.....	81	FIBAM COMPANHIA INDUSTRIAL	91
ENDURALOCK, LLC	81	FILETAGE INTERNATIONAL (INTERNATIONAL THREAD INC.)	91
ENGEL MANUFACTURING COMPANY, INC., THE.	81	FIRST AMERICAN SALES CO.....	91
ENGINEERED BOLTING PRODUCTS, INC.....	81	FISCHER SPECIAL MFG. CO.....	92
ENGINEERING MATERIALS CO., INC.....	82	FITZ MANUFACTURING INDUSTRIES LTD.....	92
FASTENER MANUFACTURING DIVISION	82	DBA FMI	92
ENGINEERING MATERIALS CO., INC.....	82	FLAIG & HOMMEL.....	92
ENGLE MANUFACTURING COMPANY, INC., THE.	83	FLEXALLOY INC.....	92
ENOMOTO INDUSTRIES CO., LTD.	83	FLIP PERILLO FASTENERS, INC.....	92
ENVISION TECH, INC.....	83	FLORES ENTERPRISES.....	93
ERICO FASTENING SYSTEMS.....	83	FLUIDONICS INC.....	93
ERIE BOLT CORP.....	83	FLUIDYNE CORPORATION	93
ESCO PRECISION, INC.....	83	FMW, INC.....	93
ESMET, INC.	83	FOCUS HOPE.....	93
DBA ELECTROLINE TTUFLOC	83	FOCUS HOPE.....	93
SUB OF UNIMET CORP	83	FOLSOM TOOL & MOLD CORP.....	93
ESNA (MACLEAN-FOGG COMPANY)	84	FONTAL CONTROLS, INC.....	94
ESP MANUFACTURING CO., INC.....	84	FONTANA S.A.....	94
ESSENTIAL MACHINING.....	84	FOREMOST PRECISION INSTRUMENT CORP.	94
ESTA PRODUCTS COMPANY	84	FOREST FASTENERS	94
EVERLOCK FASTENING SYSTEMS.....	84	FORMED FASTENER MANUFACTURING, INC.....	94
EVERLOCK DETROIT DIVISION.....	84	FPA MANUFACTURING	94
EVERLOCK FASTENING SYSTEMS.....	85	DBA FPA MANUFACTURING AND SUPPLY.....	94
GREER STOP NUT	85	FRANROE PRECISION MACHINE COMPANY	95
INTERNATIONAL SCREW DIVISION	85	FREEHOLD MANUFACTURING ASSEMBLY CO., INC.....	95
EXCEL PRECISION PRODUCTS, INC.....	85	FREEMAN CO.....	95
EXPERIMENTAL MACHINE CO.....	85	FRIEDR BOESNER GMBH.....	95
EXTREME BOLT & FASTENER, LLC.....	86	FRISBY AEROSPACE INC DE.....	95
EXTREME PRECISION SCREW PRODUCTS, INC..	86	FRONTIER BOLT COMPANY OF TEXAS.....	95
FABER ENTERPRISES, INC.....	86	FUCHS SCHRAUBENWERK GmbH	96
FABRICATION SPECIALTY INC.....	86	G & R SCREW MACHINE PRODUCTS.....	96
FABSCO CORP.....	86	G & S MACHINE INC.....	96
FAILING CO., GEORGE E.....	86	G. B. MACHINE PRECISION, INC.....	96
FALCON MANUFACTURING CORP.....	86	G.B. DUPONT CO., INC.....	96
FALL RIVER MANUFACTURING CO., INC.....	87	GAITHER MACHINE	96
FANG SHENG SCREW CO., LTD.....	87	GALAN PRECISION MACHINE CO.....	97
FARIAS INDUSTRIAL MACHINING	87	GALMAC MFG CO.....	97
FARLO MACHINE & TOOL CO., INC.....	87	GARCIA INDUSTRIES, INC.....	97
(FASSCO) FASTENER & STEEL SUPPLY CO., LTD.	87	GARDINER MFG. CO.....	97
.....	87	GATES ALBERT, INC.....	97
FASTCO INDUSTRIES, INC.....	88	GATEWAY SCREW AND RIVET, INC.....	97
FASTENAL COMPANY	88	GEN FAST MANUFACTURING COMPANY.....	97
FASTENER BROKERAGE INC.....	88	GENERAL AVIATION MFG., INC.....	97
DBA INOFAST MANUFACTURING INC.....	88	GENERAL MACHINE PRODUCTS, INC.....	98
FASTENER DIMENSIONS, INC.....	88	GENERAL SCREW & SPECIALTY CO., INC.....	98
FASTENER INNOVATION TECHNOLOGY, INC.....	88	GERMAN MACHINED PRODUCTS, INC.....	98
DBA F.I.T.....	88	GERTLER INDUSTRIES, INC.....	98
FASTENER TECHNOLOGY CORP.....	89	GFD LETAGE.....	98
FASTENING PRODUCTS CO.,INC.....	89	GILL MACHINE & TOOL CO.....	98
FASTENERS UNLIMITED INC.....	89	GL CNC SERVICE INC.....	98
FASTENING PRODUCTS OF LANCASTER, INC.	89	GMJ MACHINE COMPANY, INC.....	99
FASTENRATH BEFESTIGUNGSTECHNIK GmbH ...	89	GMP CO. CORPORATION	99
FASTI-WERK CARL AUG. FASTENRATH GMBH & CO.KG	89	GOWER MACHINE LLC	99
FASTRON COMPANY, THE	90	GOSHO WORKS, LTD.....	99
FEDERAL EQUIPMENT COMPANY	90	GRACO INDUSTRIES, INC.....	99
FEDERAL MANUFACTURING CORP.....	90	GRADON SCREW MACHINE CORP.....	100
FEDERAL SCREW WORKS	90	GRANDEUR FASTENERS, INC.....	100
BIG RAPIDS DIVISION.....	90	GRAUCH ENTERPRISES.....	100
FENBAR PRECISION MACHINISTS, INC.....	91	GREATER MARYLAND TOOL & MFG., CORP.	100
FENTON HEADING.....	91	GREEN BAY DROP FORGE	100
		DIV. OF CLEVELAND HARDWARE & FORGING	100
		GREENFIELD MANUFACTURING CO., INC.....	100
		GREER STOP NUT.....	101
		GRIPCO, DIVISION OF BLACK & DECKER	101

MIL-HDBK-57J (GS7)
INDEX A

GROOV-PIN CORPORATION.....	102	HOLLYWOOD MANUFACTURING INC.	112
GRUPO RASSINI S.A. de C.V.....	102	HOLO-KROME CO.....	112
RASSINI INTERNATIONAL, INC.....	102	HORSPPOOL & ROMINE MANUFACTURING CO., INC.	112
GS AEROSPACE	102	112
DIV. B & B SPECIALTIES INC	102	HORST ENGINEERING & MANUFACTURING CO.	112
GSF FASTENING	102	HOUSTON FASTENER	112
GUARDIAN RIVET & FASTENER.....	103	DIVISION OF WESTBROOK MFG	112
GULF FASTENER, INC.....	103	HOUSTON PRECISION FASTENERS	113
GUNNISON-INTERNATIONAL INC.....	103	HOWARD TOOL CO., INC.....	113
H C MERCHANDISERS INC. DBA H C PACIFIC	103	HOWE MACHINE AND TOOL CORP.....	113
H C PACIFIC.....	103	HOWELL PRECISION, INC.....	113
H. MULLINS, LTD.....	103	HOWIE MANUFACTURING CO., INC.....	113
BADE INDUSTRIAL ESTATE.....	103	HUCK INTERNATIONAL INC.....	114
H. PAULIN & CO. LTD.....	103	CARSON OPERATIONS.....	114
CAPITAL METAL INDUSTRIES DIVISION	103	LAKEWOOD OPERATIONS	114
H. PRINZ GmbH FABRIK FUR		TUCSON OPERATIONS.....	114
VERBINDUNGSELEMENTE	104	HUCK INDUSTRIAL PRODUCTS.....	114
HABINA ENGINEERING	104	HUCK PRODUCTS	114
HALL INDUSTRIES INC.....	104	HUGGINS MFG.....	114
HALLSIMS INDUSTRIAL COMPONENTS, INC.....	104	HUGO DURHOLT GMBH & CO. KG	114
HAMANAKA (THAILAND). CO., LTD.	104	HUNT VALVE COMPANY, INC.	114
HANDI GADETS CORP.....	104	DBA WAECO VALVE DIVISION	114
HANSAN SCREW CO., LTD.	105	HUNTER STEVENS COMPANY.....	114
HARDWARE SPECIALTY CO, INC.....	105	HUNTINGTON VALLEY INDUSTRIES, INC	115
HARRISON BOLT & NUT CO., THE	105	DBA HVI	115
HARTFORD AIRCRAFT PRODUCTS, INC.....	105	HURON AUTOMATIC SCREW CO.	115
HARWOOD DESIGN, INC.....	105	HURRICANE MACHINE COMPANY, L.L.C.....	115
HASKELL OF HUNTINGTON, INC.....	105	HYDRO FITTING MFG. CORP.	115
HASSALL, JOHN, INC.....	106	HYDROBOLT LIMITED	115
HATCH INDUSTRIES.....	106	I.G.D. MACHINE & TOOL LTD.....	115
HAWTHORNE BOLT WORKS	106	IDEAL FASTENERS INC.	115
HAYDON BOLTS, INC.....	106	IFASTGROUPE 2004 LP	116
HAZE SEIKO CO., LTD	106	INFASCO.....	116
HEARTLAND PRECISION FASTENERS, INC.....	107	INFASCO NUT	116
HEIM'S MACHINE & TOOL, INC.....	107	INGERSOLL FASTENERS	116
HEITCO MANUFACTURING, INC.....	107	IMPERIAL SUPPLIERS, INC.	116
HEMCO TOOL INC.....	107	INCO TECH AEROSPACE FASTENERS, INC.	116
HENAN AEROSPACE PRECISION MACHINING CO.,		INDIANA AIRCRAFT HARDWARE	116
LTD.....	107	INDUSTRIAL & AUTOMOTIVE FASTENERS	117
HENWAY, INC.....	107	DIVISION OF KEY MANUFACTURING GROUP,	
HEPTNER MFG CO	108	INC.	117
HESSISCHE SCHRAUBENFABRIK WELTER GmbH &		INDUSTRIAL FASTENERS CORP.....	117
CO., KG	108	INDUSTRIAL FORGE, INC.....	117
HEWINS, EDMOND, C. JR.....	108	INDUSTRIAL NUT CORP.	117
DBA JET MACHINE WORKS COMPANY	108	INDUX, S.A. DE C.V.....	118
HEXAGON ENTERPRISES, INC.	108	INFASCO.....	118
HG AEROSPACE ENGINEERING LTD	108	INFASCO NUT	118
HI INDUSTRIAL TECHNOLOGIES	108	INFASTECH DECORAH LLC.....	118
HIGH QUALITY MACHINE SHOP.....	108	INGERSOLL FASTENERS	118
HIGH TECH ENTERPRISES.....	108	INLAND MACHINE COMPANY INC.	118
HIGHLAND PRODUCTS CORPORATION	109	INOFAS MANUFACTURING INC.....	119
HIGHLAND THREADS, INC.....	109	IN-SPECK CORP.....	119
FASTENER MANUFACTURING DIVISION	109	INSTRUMENT MACHINING SERVICE LTD.....	119
HILL AEROSPACE & DEFENSE LLC.....	109	INTERFLEX MFG. CORP.	119
HILL FASTENER CORP.....	109	INTERSTATE FITTINGS INC.....	119
HILL STAMPING & MFG., INC.....	109	IRON BOUND MANAGEMENT GROUP.....	119
HILTI, INC.....	110	IRVING MACHINE SERVICE, INC.....	119
HI-SHEAR CORP.	110	IRWIN AUTOMATION, INC.....	119
DBA FOREIGN PARENT IS LISI PARIS FRANCE		ISLAND ENGINEERING	120
.....	110	DBA J SMITH MACHINE SHOP INC	120
HLC INDUSTRIES INC.....	110	ITT HARPER AEROSPACE FASTENER	
HMS SERVICES LLC	111	OPERATIONS	120
HO-HO-KUS, INC.....	111	AEROSPACE CONTROLS DIVISION	120
HO HONG WORKS CO., LTD.....	111		
HOFFMANN, RICHARD GMBH CO. KG.....	111		
HOFFMANN MACHINE COMPANY, INC.....	111		
HOLAN, INCORPORATED.....	111		

MIL-HDBK-57J (GS7)
INDEX A

ITW BUILDEX	120	KEYSTONE BOLT & NUT COMPANY	128
ITW CIP	120	KEYSTONE THREADED PRODUCTS DIVISION	
IVACO INC.....	120	128
INFASCO	120	KEYSTONE TOOL & MACHINE CO.....	128
INFASCO NUT.....	120	KILBOURN ENGINEERING CO.	128
INGERSOLL FASTENERS.....	120	KIRSTEN PIPE CO. INC.	128
J & M MACHINE INC.....	121	K.L.M. MACHINE INC.	128
J & M MACHINING LLC.....	121	KLINCHER LOCKNUT CORP.....	128
J & S PRECISION PRODUCTS	121	KNIPPING-DORN GmbH KALTUMFORMTECHNIK	128
J.F. FREDERICKS TOOL CO.....	121	KNOCH MANUFACTURING CO. LTD.....	129
J. G. FASTENERS.....	121	KO AMS MACHINE PRODUCTS.....	129
J. GEORG BIERBACH	121	DBA KOAM MACHINE	129
J.M. PRECISION, INC.....	122	KOBE FASTENER LIMITED	129
FASTENER DIVISION	122	KOLB GMBH & CO.	129
J.P. PRODUCTS, INC.	122	KONDOR TECHNOLOGIES, INC.	129
DBA SPECIALITES, UNLIMITED	122	KONGO BYORA CO., LTD.	129
JACOBSON MFG., LLC.....	122	KOREA BOLT IND., CO., LTD.	129
JACO ENGINEERING, INC.	122	FOREIGN TRADE DEPARTMENT	129
JAM TECH CORP.....	122	KORODY COLYER CORP.....	130
JAMES IPPOLITO & CO., INC.	122	KOZAK, E. PRECISION PRODUCTS CO.	130
JAMES JACKSON	122	KPF.....	130
DBA J J ENGINEERING	122	KREIS TOOL & MFG., CO., INC.....	130
JAMISON INDUSTRIES INC.....	122	KROBACH MANUFACTURING CORP.....	130
JANUS FASTENING SYSTEMS, INC.	123	KSS SOCKET SCREW, INC.	130
JAY BEE MACHINE WORKS, INC.....	123	K-TECH MFG., INC.	130
JAY O MACHINE CO., INC.	123	KYOEI SEISAKUSHO CO., LTD.	131
JAYCO ENGINEERING, INC.....	123	KYOKUTO MFG CO LTD.....	131
JE A ENTERPRISES, INC.....	123	L & C MANUFACTURING CO., INC.	131
JERGENS INC.....	123	L & H THREADED RODS CORP.....	131
DBA JERGENS INDUSTRIAL SUPPLY	123	DIV OF GRAY AMERICA CORP.....	131
JEWELL TOOL TECH	123	L & J FASTENERS, INC.....	131
see KARMA INC	123	L & M ENTERPRISES, INC.....	131
JINN HER ENTERPRISE CO., LTD.	123	L. A. MARTIN CO.....	131
JJ ENGINEERING	124	L G MACHINE & MFG INC.....	131
JJ SCREW PRODUCTS, INC.....	124	L H INDUSTRIES, INC.....	132
JMT MACHINE COMPANY	124	TIP TOP TOOL CO.	132
JOHN R. BROMILEY COMPANY INC.....	124	L N AEROSPACE, INC.	132
JOLICO/J-B TOOL INC.....	124	L P R PRECISION PARTS AND TOOL COMPANY,	
JOSLYN CORP.....	124	INC.	132
MACLEAN POWER SYSTEMS.....	124	L R G CORPORATION	132
JUNIPER ELBOW CO.	124	LAKE ERIE SCREW CORP.	132
JUPITER WASHERS, INC.....	125	LaMOTT ENTERPRISES, INC.....	132
JUST IN TIME, INC.....	125	LAMSON AND SESSIONS OF CANADA LTD.	133
DBA APSCO	125	RB & W CORP. METAL FORMING DIVISION....	133
K & K PRECISION ENTERPISES	125	LANA INDUSTRIES	133
K.A.A. COMPANY.....	125	LANARKSHIRE BOLT LTD.	133
LYNN ABADIE DBA K A A COMPANY	125	LAND-SEA-AIR MACHINED PRODUCTS, INC.....	133
K.D.K. UPSET FORGING CO.	125	LANIS MACHINE & MFG., CO.....	133
KAMAX-WERKE RUDOLF KELLERMANN GmbH &		LANUM METAL PRODUCTS, INC.....	134
CO. KG	125	LAWSON PRECISION MACHINING, INC.	134
KAMAX L. P.....	125	LBL PRODUCTS	134
KAMPWERK VIAREGGE U. PICKARDT GMBH. & CO		LEBRECHT TIGGES GmbH & CO. KG	134
.....	126	LEE AEROSPACE PRODUCTS, INC.	134
KAPCO INDUSTRIES, INC.	126	LEHNER SCREW MACHINE CO.....	134
KARMA INC.....	126	LELAND-POWELL FASTENERS, INC.	134
DBA JEWELL TOOL TECH	126	LENCH, THOMAS WILLIAM, LTD.	135
KATSURAGAWA MACHINE SCREW CO., LTD.....	126	LENTERN (AIRCRAFT) LTD.....	135
KAYGOR, INC.	126	LEONARD JED CO.....	135
KAYNAR PRODUCTS	127	MARYLAND BOLT AND NUT CO DIV.....	135
KELLER ENGINEERING.....	127	LEP SPECIAL FASTENERS INC.....	136
KELOX/MICRODOT PRODUCTS	127	LEVEL 1 FASTENERS.....	137
KEN FORGING, INC.....	127	LEVINGSTON MACHINE COMPANY	137
KERR, CHARLES W.....	127	LEWIS SCREW COMPANY.....	137
KERR LAKESIDE INC.....	127	DIV OF MEDALIST FASTENERS INC.....	137
		LFC INDUSTRIES INC.....	137
		DIVISION RKR TECHNOLOGIES.....	137

MIL-HDBK-57J (GS7)
INDEX A

LIGHTNING BOLT & SUPPLY, INC.....	138	LEONARD JED CO.....	148
LINREAD NORTHBRIDGE.....	138	MASTER BOLT & MFG. INC.....	149
LINREAD NORTHBRIDGE AIRCRAFT PRODUCT DIVISION.....	138	MASTER RESEARCH & MFG., INC.....	150
LIPPISCHE EISENINDUSTRIE GmbH.....	140	MASTERBILT, INC.....	150
LISI AEROSPACE.....	140	MASTERCRAFT TOOL COMPANY.....	150
A1 TECHNOLOGIES.....	140	MAUDLE INDUSTRIAL CO., LTD.....	150
LISI AEROSPACE CANADA.....	140	MAUI MEGA.....	150
BLANC AERO INDUSTRIES VILLEFRANCHE DE ROUERGUE.....	140	DBA KERR, CHARLES W.....	150
BLANC AERO INDUSTRIES RUGBY.....	140	MCADAMS MACHINE AND TOOL CO.....	150
BLANC AERO INDUSTRIES SAINT OUEN L'AUMONE.....	140	MCCULLOUGH AERO CO.....	150
BLANC AERO TECHNOLOGIES.....	141	DBA MCCULLOUGH & ASSOCIATES.....	150
BLANC AERO INDUSTRIES VIGNOUX.....	141	MCLANE MFG INC.....	151
DECOLLETAGE GENERAL MODERNE.....	141	McMELLON BROS INC.....	151
FT BESTAS.....	141	MD3 INDUSTRIES LTD.....	151
FTB FASTENER TECHNOLOGY BESTAS.....	141	MEACO PRODUCTS CORP.....	151
HI-SHEAR CORPORATION.....	141	MEC WOLF SRL.....	151
THE MONADNOCK COMPANY.....	141	MECAERO PRODUCTS.....	152
LITTLE WORLD MANUFACTURING, INC.....	142	MECAERO CANADA INC.....	152
LLOYD MACHINE & TOOL CO., INC.....	142	MECAIR AEROSPACE INDUSTRIES SUBSIDIARY OF SPS TECHNOLOGIES DIV DIVISION OF SPS TECHNOLOGIES.....	152
LN AEROSPACE, INC.....	142	DBA MECAIR INC.....	152
LOBO OFFICINE MECCANICHE SPA.....	142	MECHANICAL & INDUSTRIAL FASTENERS.....	152
LOBO SYSTEMS LTD.....	142	MECHANICAL INDUSTRIES LLC.....	152
LONESTAR FASTENERS.....	142	MEL-BA MANUFACTURING INC.....	152
LONG-LOK FASTENERS CORP.....	143	MERCER PRODUCTS & MFG. CO., INC.....	153
LOOS & CO., INC.....	143	MERCURY AEROSPACE INC.....	153
AEROSPACE FASTENERS DIVISION.....	143	MERCURY TOOL & MACHINE, INC.....	153
LORD CORPORATION.....	143	METALCRAFTERS.....	153
AEROSPACE PRODUCTS DIVISION.....	143	DIVISION OF KEYSTONE CONSOLIDATED INDUSTRIES.....	153
LOUGHLIN MANUFACTURING CORP.....	143	METAL-TECH MFG. INC.....	153
M & M MANUFACTURING CORPORATION.....	143	METHODS AND MACHINING SERVICES CO.....	153
M.A.A. CORP.....	144	METRO TOOL & MANUFACTURING CO.....	154
MID AMERICA AEROSPACE DIVISION.....	144	see ALEXANDER MANUFACTURING COMPANY INC.....	154
M.L.W. MANUFACTURING CO.....	144	METRIX MFG. CO.....	154
M.S. AEROSPACE.....	144	MEXEM WORKS.....	154
MAC FASTENERS, INC.....	144	MI. ME. AF. S.r.l.....	154
MACHINE SHOP, INC., THE.....	144	MICRO SCREW MACHINE PRODUCTS, INC.....	154
MACHINERITE CORP.....	144	MICRODOT INC.....	155
MACHINING LOGISTICS, INC.....	144	MICRODOT AEROSPACE FASTENING SYSTEMS GROUP ADVANCED PRODUCTS DIV.....	155
MACK, A. W. MFG CO.....	145	KAYNAR TECHNOLOGIES INC MICRODOT DIV	155
MACKO INDUSTRIES.....	145	MICRODOT INSERTS DIVISION.....	155
MACKSON MFG CORP.....	145	MID CONTINENT SCREW PRODUCTS CO.....	155
MACLEAN SKY.....	145	MID-STATES SCREW CORP.....	155
MACLEAN-ESNA.....	145	MIDWEST ACORN NUT CO.....	155
MACLEAN-FOGG CO.....	146	MILE-HI MACHINE, INC.....	155
MACOR, INC.....	146	MILITARY & COMMERCIAL FASTENER CORP.	156
MAGNUM MACHINE SHOP.....	146	MILITARY PRODUCTS GROUP, INC.....	156
MAGNUS TOOL & DIE CO., INC.....	146	MILLIPART, INC.....	156
MAILLY MFG CO., INC.....	146	MILLS, J. R. MACHINING, INC.....	156
MAIN MACHINE CO INC.....	147	MIL-SPEC FASTENERS CORP.....	156
DBA MAIN MACHINE & TOOL CO.....	147	MINEBEA CO. LTD FUJISAWA MANUFACTURING UNIT.....	157
MANUFACTURING ENGINEERING TECH.....	147	MIROFINE COMPANY.....	157
MANUFACTURING SALES AND SERVICE.....	147	MI-TECH, INC.....	157
MANUFACTURING TECHNOLOGY SERVICES.....	147	MITSUBOSHI INDUSTRIES, LTD.....	157
MAPECO PRODUCTS, INC.....	147	OSAKA DIVISION.....	157
MAR-BRO MFG., INC.....	147	MIX TOOL CO.....	157
MARTIN-CHANDLER, INC.....	148	MKM MACHINE TOOL COMPANY INC.....	158
MARUYKO NUT CO., LTD.....	148	M-MANUFACTURING.....	158
MARVIN ENGINEERING, CO., INC.....	148		
MARYLAND BOLT & NUT CO., INC.....	148		

MIL-HDBK-57J (GS7)
INDEX A

MMG ENGINEERED COMPONENTS INC. DBA	158	OHKAWA SCREW MFG. CO., LTD.	170
TOOLSOURCE	158	OKABE CO., INC.	170
MNP CORPORATION	159	OKAI IRON WORKS, INC.	170
MODERN METRIC MACHINE COMPANY INC	159	OKAWA SCREW MANUFACTURING CO., LTD.	170
MODFORM-ILLINOIS, INC.	159	OMEGA THREAD ROLLING AND GRINDING INC.	170
MONADNOCK COMPANY, THE	159	ONDRIVES. US CORP	170
MONOGRAM AEROSPACE FASTENERS	160	ONEIDA TOOL & MACHINE CORP	171
MONROE MACHINED PRODUCTS, INC.	160	ONO MANUFACTURER, INC.	171
MONTEREY MACHINE PRODUCTS	160	ONTIC ENGINEERING & MANUFACTURING, INC.	171
MORTON FASTENERS INC.	160	ORANGE PRECISION PARTS	171
MORTON MANUFACTURING	160	ORC PRODUCTS INC.	171
MOSE ENGINEERING AND MANUFACTURING INC.	160	ORC-O TOOL & MACHINE, INC.	171
	160	ORDNANCE PARTS & ENGINEERING CO.	172
MOSTAR GEAR & MACHINE MFG., CO.	161	ORLOTRONICS CORP	172
MOTOR WHEEL CORP.	161	OSAKA SEIKI CO., LTD.	172
MPIRE FASTENERS	161	OSTEEN MACHINE SHOP	172
MRL MANUFACTURING CORP.	161	OTO MELARA S.p.A.	172
N.S.S. INDUSTRIES	161	FINKECCANICA COMPANY	172
NAFCO USA, LLC	161		
NAGOYA SCREW MANUFACTURING CO, LTD.	162	OTT BROTHERS MACHINE CO., INC.	172
NAPIER'S AUTO BODY	162	OTTAWA PRODUCTS CO., INC.	172
NARRAGANSETT SCREW MFG. CO.	162	OWARI PRECISE PRODUCTS CO., LTD	172
NASSAN TOOL WORKS, INC.	162	P & I ASSOCIATES, INC.	173
NASU DENKI-TEKKO CO., LTD.	162	P & L ENTERPRISES	173
NATIONAL AEROSPACE FASTENERS		P.C.M., INC.	173
CORPORATION (NAFCO)	163	BETHLEHEM PIKE INDUSTRIAL CENTER	173
NATIONAL BOLTS & RIVETS LTD.	163		
NATIONAL FASTENER CO., LTD.	163	P.S. MACHINE CO., INC.	173
NATIONAL THREADED FASTENERS CORP.	163	PABCOR, INC.	173
NAVPAR, INC.	163	PACER ALLOYS, INC.	173
NC AUTOMATED INDUSTRIES INC.	163	PACIFIC FASTENERS, INC.	173
NCFI BRUEGGEMANN INC.	164	PACIFIC SCIENTIFIC	174
ND INDUSTRIES	164	PACIFIC TOOL, INC.	174
NEDSCHROEF HALMOND B.V.	164	PADGETT MACHINE INC.	174
NEKG HOLDINGS	164	PAINTER TOOL, INC.	174
NELSON AEROSPACE INC.	164	PALNUT CO.	174
NELSON STUD WELDING DIVISION	164	UNITED CARR FASTENERS PALNUT DIV	174
NEUMAYER, ERICH GMBH.	164		
NEVADA BOLT AND MFG CO INC.	165	PANTHER MACHINING AND HARDWARE	174
NEVILLE MACHINE SHOP	165	PAOLO ASTORI SPA	174
NEW HORIZON MACHINE CO., INC.	165	PARK PRECISION CORPORATION	174
NICE TOOL MFG., INC.	165	PARKER FASTENERS, LLC	175
NINGBO JINDING FASTENING PIECE CO, LTD.	165	PATEREX, LTD.	175
NIPPON MACHINE ENGINEERING, INC.	165	PATRIOT MANUFACTURING	175
NIPPON STEEL BOLTEN CO., LTD.	166	PATTERSON LAKE PRODUCTS	175
NISCO, INC.	166	PAULIN, H. & CO., LTD.	175
NISSAN SCREW CO. LTD.	166	CAPITAL METAL INDUSTRIES DIVISION	175
SALES DEPT., FORIGN TRADE SECTION.	166		
		PB FASTENERS	176
NOCHIA STEELWORKS	166	PEAR, INC.	176
NON-FERROUS BOLT & MANUFACTURNG CO.	166	PECO AEROSPACE FASTENERS	176
NORTHBRIDGE FASTENERS	167	PEERLESS SCREW PRODUCTS	176
NORTH EAST FASTENERS	167	PEINER UMFORMTECHNIK GmbH	177
NORTHEAST METAL CO., INC.	167	PELHAM AUTO MATRIX PRECISION	177
NORTHERN SCREW CO., INC.	167	PENN CIGAR MACHINES INC	177
NORTHSTAR ENGINEERING	167	PENN ENGINEERING & MANUFACTURING CORP.	177
NOVA MACHINE PRODUCTS, INC.	168		177
NSK INDUSTRIES, INC.	168	PENN ENGINEERING & MANUFACTURING CORP.	178
NT ENGINEERING, INC.	168		178
NUCOR CORP.	168	PENN SCREW & MACHINE WORKS, INC.	179
NUCOR FASTENER DIVISION	168	PENNENGINEERING AUTOMOTIVE FASTENERS	179
		PEREZ MACHINE, INC.	179
NUMERIC MACHINE PRODUCTS	168	PERIGEE MANUFACTURING COMPANY, INC.	179
NUTS INCORPORATED	168	PERKINS MACHINE CO.	179
DIVISION OF STANLOK	168	PHOENIX SPECIALTY MANUFACTURING CO., INC.	179
			179
NUTS, INC.	168	PILGRIM SCREW CORP.	180
NYLOK FASTENER CORPORATION	169	PINE TAVERN MACHINE INC.	180
OAKTREE FASTENERS CO.	169	PINEY RIDGE CO.	180
OBARS MACHINE & TOOL CO.	169	PINTO PRODUCTS	180
OCM MACHINE COMPANY, INC.	169	PIONEER MACHINE PRODUCTS, INC.	180
OHIO NUT & BOLT CO., THE	169	PIONEER SCREW & NUT CO.	180
DIV. OF FASTENERS INDUSTRIES, INC.	169	PLAINVILLE MANUFACTURING CO., INC.	181

MIL-HDBK-57J (GS7)
INDEX A

PMB PRECISION PRODUCTS INC.....	181	RAMAR NUTS, INC.....	191
DBA SPARTAN INSTRUMENTS.....	181	RAMCO SPECIALTIES, INC.....	191
PNEU-HYDRO PRODUCTS, INC.....	181	RAMM DEFENSE PRODUCTS.....	192
POINT MACHINE COMPANY.....	181	RATHMANN WALTER G. SEGMENT- KLAMMERSCHRAUBEN GMBH.....	192
POLYTECHNIC INDUSTRIES.....	181	RA-WHITE, INC.....	192
PORTLAND BOLT & MFG., CO.....	181	RB & W CORP.....	192
PORTSMOUTH NAVAL SHIPYARD.....	181	REED INSTRUMENT CO.....	193
POSIMECH, INC.....	182	REGAL AIR, INC.....	193
POWER GEN COMPONENTS, LLC.....	182	REID PRODUCT INC.....	193
POWERPARTS, INC.....	182	RELIANT FASTENER.....	193
PRD FASTENERS LTD.....	182	RELI TECHNOLOGY, INC.....	193
PRECI-MANUFACTURING, INC.....	182	REPUBLIC FASTENER MANUFACTURING CORP.....	193
PRECISE AERO PRODUCTS.....	182	193
PRECISE OF CALIFORNIA.....	182	REXNORD INC.....	194
DIV OF ADJUSTABLE BUSHING CORP.....	182	TRIDAIR PRODUCTS.....	194
PRECISION AIRCRAFT MACHINING CO., INC.....	183	CAMLOC PRODUCTS.....	194
PRECISION FITTINGS, INC.....	183	ROSAN PRODUCTS.....	194
PRECISION MACHINING COMPANY.....	183	RHIMCO INDUSTRIES, INC.....	194
PRECISION METAL PRODUCTS CO.....	183	RICHARD MANNO & CO., INC.....	194
PRECISION PARTS & TOOL CO., INC.....	183	RICHARD MFG. CO., INC.....	194
PRECISION PIECE PARTS, INC.....	183	RINCO TECHNOLOGIES, INC.....	195
PRECISION SCREW & BOLT, INC.....	183	RING SCREW WORKS.....	195
PRECISION TECHNOLOGIES, INC.....	184	FENTON HEADING.....	195
PRECISION THREADED PRODUCTS, INC.....	184	FERNDALE FASTENER.....	195
PRECISIONMATICS CO., INC.....	184	RING SCREW DIVISION.....	195
PREM INDUSTRIES, INC.....	184	SEMCO FASTENER.....	195
PRESTIGE STAMPING, INC.....	184	TITAN FASTENER.....	195
PRICE MANUFACTURING CO.....	184	RIPA ENGINEERING CORP.....	196
PRIETO MACHINE COMPANY, INC.....	185	RIPPA PRODUCTS.....	196
PRODUCT DEVELOPMENT GROUP, INC.....	185	RISCO, INCORPORATED.....	196
PRODUCTION & TOOL COMPANY.....	185	RIVER VALLEY TOOL & MANUFACTURING.....	196
PRODUCTS DESIGN & MFG. CORP.....	185	RIVNUT ENGINEERED PRODUCTS, INC.....	196
PROFORMANCE MANUFACTURING, INC.....	185	RMS.....	196
PRO-MACHINE & TOOL COMPANY.....	185	ROBBINS MANUFACTURING.....	196
PROMPTUS ELECTRONIC HARDWARE.....	185	ROBERT HENRY CO., INC.....	197
PROTO MACHINE CO., INC.....	186	ROCKFORD BOLT & STEEL CO.....	197
PTM INTERNATIONAL INC.....	186	ROCKFORD FASTENERS INC.....	197
PURITAS METAL PRODUCTS.....	186	ROCKFORD PRODUCTS CORP.....	197
PV ENGINEERING & MFG. INC.....	186	ROGG MANUFACTURING COMPANY.....	198
PYE & HOGAN MACHINE CO.....	186	ROLAND AEROSPACE.....	198
QRP, INC.....	186	ROMAC ELECTRONICS, INC.....	198
QSN MANUFACTURING, INC.....	186	RONSON MANUFACTURING, INC.....	198
QUALITY AIRCRAFT SCREWS, INC.....	186	ROSAN PRODUCTS.....	198
QUALITY BOLT & SCREW CO.....	187	ROTAIR INDUSTRIES, INC.....	198
Division of ELGIN FASTENER GROUP LLC.....	187	RS MANUFACTURING, INC.....	198
QUALITY FABRICATIONS, INC.....	187	RUDOLPH INSTRUMENTS, INC.....	199
QUALITY MACHINE & MFG INC.....	187	RUDOLPH PRECISION PRODUCTS.....	199
QUALITY MACHINE SERVICES LLC.....	187	RUMCO, INC.....	199
QUALITY SCREW PRODUCTS, INC.....	187	RUSCOMB TOOL & MACHNE CO., INC.....	199
QUALITY SOCKET SCREW MANUFACTURING CORP.....	187	S & L FASTENERS, LLC.....	200
QUALITY THREADED PRODUCTS COMPANY.....	187	S & L METAL PRODUCTS CORP.....	200
R & D FASTENERS.....	188	S & L TOOL.....	200
R & D WELDING & MACHINE INC.....	188	S. B. E. (ITALY CORPORATION).....	200
R & I ENTERPRISES.....	188	S.A.B.A. S.p.A. BULLONERIA E. AFFINI.....	200
DBA COMPULOGIC DESIGN CO.....	188	S.I. STUD, INC.....	200
R & R PRECISION.....	188	SABRE MANUFACTURING, INC.....	201
R B & W CORPORATION.....	189	SAFETY SOCKET LLC.....	201
R. BILD COMPANY, INC.....	189	SAFETY SOCKET SCREW CORP.....	201
R.E.C. CORP.....	190	SAGA TEKKOSHO CO., LTD.....	202
RABOURDIN.....	190	SAI INDUSTRIES CORP.....	202
RADAX INDUSTRIES, INC.....	190	SALEM MANUFACTURING AND SALES, INC.....	202
RAE MANUFACTURING CO.....	190	SALES SYSTEM, LIMITED.....	202
RAGHU VAMSI MACHINE TOOLS PVT LTD.....	190	SAMUEL MARSDEN & SON.....	202
RAHMEDE SCHRAUBENFABRIK.....	190	SANDIK MANUFACTURING, INC.....	202
RAINBOW MACHINE PRODUCTS, INC.....	191	SANNOHASHI SEISAKUSHO CO., LTD.....	202
RAM ENTERPRISES.....	191	SANTA ANA GEAR & MACHINE.....	202
RAM PRODUCTS.....	191		
RAM THREADING, INC.....	191		

MIL-HDBK-57J (GS7)
INDEX A

SANTA ANA SCREW PRODUCTS INC.....	203	METALAC SPS INDUSTRIA E COMERCIO LTDA.	213
SATAIR MANUFACTURING FACILITY	203	UNBRACO PTY LTD. AUSTRALIA.....	214
SATURN FASTENERS, INC.	203	SPS TECHNOLOGIES LIMITED.....	214
SCANDIA MFG. CO., INC.	203	SPS TECHNOLGOIES LIMITED.....	214
SCHMICO GMBH SCHWEISSTECHNIK	203	SPURWAY COOKE INDUSTRIES PTE LTD.....	214
SCHRAUBENFABRIK GUSTAV STERNBERG GmbH		SRI SAI INDUSTRIES CORPORATION	214
& CO. KG	203	ST. LOUIS SCREW & BOLT CO.....	214
SCHUHL & CO. GMBH.....	203	STACY MACHINE & TOOLING, INC.....	214
SCOTT CRAFT CO.	204	STALKER & DYSTHE, INC.	215
SCREWCORP	204	STANDARD LOCKNUT, INC.	215
SEILER INSTRUMENT AND MANUFACTURING		STANDARD NUT & BOLT, INC.	215
COMPANY, INC.....	204	STANDARD TOOL & MACHINE CO.	215
SEMBLEX CORPORATION	204	STAR-GLO INDUSTRIES LLC.....	215
SEMCO FASTENER.....	204	STEADFAST CORPORATION.....	215
SEMS AND SPECIALS, INC.	204	STEEL CITY BOLT & SCREW, INC.....	216
SENG HENG ENGINEERING PTE LTD.	205	STEEL PRODUCTS OF MASSILLION	216
SESCO INDUSTRIES, INC.	205	STEEL WAREHOUSE COMPANY, INC.....	216
SET SCREW & MFG. CO.....	205	STELCO FASTENER & FORGING CO.	216
SHACKELFORD MACHINIG, INC.....	205	STELFAST FASTENERS, INC.	217
SHAMROCK FASTENER TECHNOLOGIES, LLC.....	205	STELFAST FASTENERS, INC.	217
SHAW PRECISION GRINDING & THREADING.....	205	DIVISION OF STELFAST FASTENERS, LTD.	217
SHEFFIELD, INC.	206	STELFAST, INC.	217
SHEREX FASTENING SOLUTIONS, LLC	206	STERLING MACHINE COMPANY.....	218
SHIGA BOLT CO., LTD.	206	STERLING MARKING PRODUCTS IC	218
SHOPCO MANUFACTURING, INC.....	206	STERLING MFG. & SUPPLY , INC.....	218
SHORELINE MACHINE PRODUCTS, INC.	206	STEVENS MFG. CO., INC.	218
SHUR-KUT SUPPLY CORPORATION	206	STILLWATER FASTENERS, INC.	219
SHUR-LOK COMAPNY	207	STRENKERT MACHINE SHOP INC.....	219
SIERRA PACIFIC SUPPLY CO., INC.	207	STURM MACHINE CO., INC.....	219
SIERRACIN/HARRISON	207	SUBCON TOOL / ACCUTOOL MACHINE GROUP	219
SIMFER PRECISION MACHINE	207	DBA ACCUTOOL	219
SIMMONDS PRODUCTS	207	SUBURBAN INDUSTRIES, INC.	219
SINN-TECH, INC.	207	SUGAR RIVER MACHINE SHOP	219
SKY CLIMBERS FASTENERS, LLC	207	SULLIVAN BOLT CO., INC.	220
SKYLINE INDUSTRIES	208	SUNDRAM FASTENERS, LTD.	220
SKYSPARES PARTS, INC.	208	SUNLAND AEROSPACE FASTENERS	220
SLABE MACHINE PRODUCTS.....	208	SUNRISE PRECISION MFG	220
SMALL PARTS MANUFACTURING CO., INC.....	208	SUPERIOR TECHNOLOGY.....	220
SMITH MACHINE & MANUFACTURING	208	SUPREME SCREW PRODUCTS, INC.	220
SMITH WELDING, INC.....	208	S V INDUSTRIES.....	220
SONFARREL, INC.....	209	SWISS TECHNOLOGY, INC.....	220
SONIC INDUSTRIES, INC.....	209	T & E MACHINE CORP.....	221
SOUTH BAY BOLT MANUFACTURING CO.....	209	T C QUALITY MACHINING INC.....	221
SOUTHCO, INC.	209	T R MACHINE INC.	221
SOUTHERN FASTENER CORPORATION.....	209	TAIYO NUT MFG. CO., LTD.	221
SOUTHERN FASTENING SYSTEMS.....	209	TAKENAKA SEISAKUSHO CO., LTD.....	221
SOUTHWEST ALLIED PRODUCTS CO., INC.....	210	TANAKA LTD.	221
SOUTHWEST INDUSTRIAL SERVICES	210	T-B & S MFG.	222
SOUTHWIND INDUSTRIES, INC.....	210	TEBCO THREADED FASTENERS.....	222
SPACE AGE ENGINEERING, INC.....	210	TECH WELDING AND MACHINE CO.	222
SPACE CITY SCREW & MFG., INC.....	210	TECHNICAL FASTENERS, INC.	222
SPACE SCREW, INC.	210	TEK PRECISION CO., LTD.....	222
SPACE-LOK, INC.	210	TELEFAST INDUSTRIES, INC.	222
SPARTAN PRECISION MACHINE.....	210	TENS MACHINE CO., INC.....	223
SPC THREADED.....	211	TERRY MACHINE CO.	223
SPEARMAN AEROSPACE	211	TERRYCABLE, INC.	223
SPECIALS, INC.	211	TEXAS BOLT CO.....	223
SPECIAL-T-METALS.....	211	TEXAS PRECISION MFG., INC.....	223
SPECIALTY SCREW CORP.	211	TEXTRON FASTENING SYSTEMS	224
SPENCER AEROSPACE MANUFACTURING, LLC	211	TFI AEROSPACE CORPORATION	224
SPENCER INDUSTRIES, INC.....	212	TFP CORP.	224
SPIRAL TOOL CORP.	212	THIANT (BOULONNERIE DE SA).....	225
SPRING CREEK MANUFACTURING, INC.....	212	THOMAS & BETTS CORPORATION	225
SPRING INTERNATIONAL	212	THOMAS INSTRUMENT & MACHINE CO., INC.....	225
SPS TECHNOLOGIES	213	THOMAS MACHINING TECHNOLOGIES, INC.....	225
SANTA ANA DIVISION.....	213	THOMAS MFG, INC.....	226
T. J. BROOKS DIVISION.....	213	TITAN FASTENER	226
AFG DIV.....	213		
TERRY MACHINE	213		

MIL-HDBK-57J (GS7)
INDEX A















TOG MANUFACTURING CO., INC.....	226	VALLEY-TODECO	235
TOKOSHA METAL WORKS LTD.....	226	VAN PETTY MFG., INC.	235
TONG HWEI ENTERPRISE CO., LTD.....	226	VANTAGE POINT MANUFACTURING.....	236
TOOLEX, INC.	226	V-B MACHINE CO., INC.	236
TOPURA CO., LTD.....	226	FASTENER DIVISION.....	236
TORCO, INC.	227	VEGAS FASTENER MANUFACTURING	236
TORONTO FASTENERS INDUSTRIES, INC.....	227	VEGAS FASTENER MANUFACTURING	236
SUBSIDIARY OF HI-SHEAR CORP., USA	227	VENUS FASTENERS CORP.	236
TORX PRODUCTS.....	227	VERSATECH, INC.	236
CAMCAR DIVISION OF TEXTRON INC.	227	VERTEX DISTRIBUTION.....	237
TOWNE ROBINSON FASTENER CO.....	227	VICO PRODUCTS, CO.	237
KEY MANUFACTURING GROUP, INC.....	227	VICTOR PRODUCTS CORP.	237
TOWNSEND CO.....	227	VIP MFG. & ENGR. CORP.....	237
CHERRY RIVET DIVISION	227	VISSERIES & BOULONNERIES DE FOURMIES ...	237
TOYO STEEL WIRE CO., LTD.....	227	VISTA MACHINING COMPANY	238
TRI STATE TOOL & DIE CO.....	228	VISTEK INDUSTRIES.....	238
TRIAD PRODUCTS CORP.....	228	VITCO NUCLEAR PRODUCTS INC.	238
TRIDAIR PRODUCTS	228	VM MANUFACTURING CORP.	238
TRIDENT MACHINE CO.	228	VMC INDUSTRIES, INC.....	239
TRIEM INDUSTRIES, LLC	228	VOI-SHAN PRODUCTS	240
TRIUMPH GROUP OPERATIONS INC	228	VORTEX MFG CO.	241
THE FRISBY AEROSPACE INC DE	228	VOSS INDUSTRIES, INC.....	241
TRIUMPH MANUFACTURING CO., INC.	228	VOSS AEROSPACE DIVISION	241
TRONSON MANUFACTURING	228	VSI.....	241
TROY D. RAY DBA DIXON MACHINE & FABRICATION.....	229	AEROSPACE PRODUCTS DIVISION	241
TRW	229	VULCAN RIVET & BOLT CORP.	241
FASTENER DIVISION	229	WA TAI INDUSTRIAL COMPANY, LTD.....	241
TRW ELECTRONIC COMPONENTS.....	229	WALKER BOLT MANUFACTURING CO., INC.....	241
CINCH – MANADNOCK DIVISION	229	WALZ & KRENZER INC.....	242
TRY - AZTEC COMPANY.....	229	DBA MAPECO PRODUCTS DIV MAPECO PRODUCTS	242
TS TEKNADYNE	229	WARREN PUMPS LLC.....	242
TSL SERVICES.....	230	DIVISION OF COLFAX CORPORATION.....	242
TUFF FASTENERS CO.....	230	WATERBURY BUCKLE CO.....	242
TURNAMICS, INC.	230	WAYNE BOLT & NUT CO., INC.....	242
TW DESIGN AND MANUFACTURING, L.L.C.....	230	WEAVER MANUFACTURING, INC.	242
TWIST TITE MFG. INC.....	230	WEBLUK MACHINE CORP.	242
UDT, INC.	230	WELTER GMBH & CO. KG.....	242
U.P. MACHINE & ENGINEERING CO.....	230	WELTON ROLLED THREAD CORP.....	243
U.S. BOLT MANUFACTURING, INC.....	231	WESLOK	243
U.S.A SPARES INC.....	231	WEST COAST AEROSPACE, INC.....	243
ULTIMATE MACHINING & WELDING	231	WEST SHORE ENGINEERING, INC.....	243
ULTRA SONIC MACHINE CO., INC.....	231	WEST TENNESSEE LIONS BLIND IND. INC.....	243
UMPCO CORP.	231	WESTERN PACIFIC ENTERPRISES, W.P.E. INC.	243
UNIFLOW CORP.....	231	WESTERN SCREW MACHINE PRODUCTS, INC.	244
UNICORP	232	CUTTING EDGE MACHINING.....	244
UNIMETERIC CORPORATION.....	232	WESTERN SKY INDUSTRIES, INC.	244
UNISTRUT CORP.	232	DIVISION OF ATLAS CORP.....	244
UNITED BOLT & SCREW CORP.....	232	WESTFIELD FASTENERS	244
UNITED DRILL BUSHING CORP.....	232	WESTLAND STEEL PRODUCTS, LTD.	244
UNITED PRECISION PRODUCTS CO., INC.....	232	WESTWOOD PRECISION, INC.....	244
UNITED STATES DEFENSE RESEARCH & SUPPLY	233	WHAIL BOLT IND. CO., LTD	244
UNITED STEEL & FASTENERS INC.....	233	WHELAN MACHINE & TOOL CO.	245
UNITED TITANIUM, INC.	233	WHITNEY SCREW CORP.	245
UNIVERSAL MACHINE PRODUCTS.....	233	WHITTET-HIGGINS CO.....	245
UNIVERSAL PRECISION SCREWS.....	233	WIGLEY MACHINE COMPANY.....	245
UNLIMITED SCREW PRODUCTS, INC.....	233	WILHELM SCHUMACHER SCHRAUBEN-FABRIK GmbH	245
UPB ENGINEERING	234	WILLIAM'S MACHINE & FABRICATION, INC.	245
UPSTART ACQUISITIONS, CORP.....	234	WIL-NIC.....	246
URANIA ENGINEERING CO., INC.....	234	E D R INDUSTRIES INC DBA WIL-NICO	246
URBAN MANUFACTURING CO.	234	WILSON-GARNER CO.	246
URBAN MFG. CO. INC.....	234	WILT PRECISION PRODUCTS	246
US TOOL & DIE.....	234	WINEGAR, INC.	246
USP AEROSPACE SOLUTIONS, INC.	235	WINKER HERMAN GMBH & CO.....	246
UTAH TOOL & DIE, INC.....	235	KGMETALLWARENFABRIK.....	246
VALCOR ENGINEERING CORP.....	235	WINSLOW AUTOMATICS, INC.	246
VALLEY FORGE AND BOLT MFG CO.....	235		



















MIL-HDBK-57J (GS7)
INDEX A

WITTEN COMPANY, INC.....	247
WODIN, INC.	247
WOLSTENHOLME MACHINE.....	247
DBA WM ROBOTS	247
WOLTERS GMBH	247
WOLVERINE MACHINE PRODUCTS CO.	247
WOLVERINE NUT CO.....	248
WORTHEY MACHINE	248
WROUGHT WASHER MANUFACTURING INC.	248
WYANDOTTE INDUSTRIES, INC.	248
WYNNSON ENTERPRISES, INC.....	248
X-TECH INNOVATIONS INCORPORATED.....	248
XCEL MFG., INC.	248
Y2K MACHINE SHOP	249
YATES TOOL, INC.	249
YEAGER MANUFACTURING CORP.	249
DBA CUMMINS AEROSPACE	249
YOUNG ENGINEERS INC, THE	249
YOW MENGI INDUSTRIAL CO., LTD.	249
Z & B GENERAL MACHINE	249
ZAMON CO., INC.	250
ZENEX CORPORATION	250
ZERO PRODUCTS , INC.....	250

MIL-HDBK-57J (GS7)
INDEX B

INDEX B – SYMBOL

SYMBOL	COMPANY NAME	PAGE
A		
A-1	A-1 NUT AND BOLT CO., INC	2
A-1	A-1 THREAD ROLLING CO., INC	3
	ALCO MACHINE CO.	15
A325	COAE BOLTS WORKS CO., LTD.	61
A+	ACCURATE TOOL CO., INC	5
A	AAP ACQUISITION CORP	3
	ABRASIVE CUTTING CORP.	3
A	ACCURATE PRECISION FASTENERS, INC.	4
	ACCUTURN CORPORATION	5
A	ACHILLES AEROSPACE PRODUCTS, INC.	6
	ACME INDUSTRIAL COMPANY	6
	ACME MACHINE PRODUCT	6
	ACME SCREW COMPANY	6
	ADAMS, EARL M. CO.	Error! Bookmark not defined
A	ADVANCED CNC MANUFACTURING	8
a	ADVANCED MACHINING & FABRICATING, INC.	8
a	ADVANCED PLASTICS, INC.	8
A A & A	AERO & AUTO STUD SPEC.	9
	AEROFASST SUPPLY	10
	AEROSPACE MACHINE PRODUCTS	10
A	AEROSPACE PRODUCTS, INC.	11
 A	AEROSTAR FASTENER CORP.	11
A*	AEROWIND CORPORATION	12
 	AFI INDUSTRIES, INC.	12
	AIR INDUSTRIES CORPORATION	12
	AIRCRAFT FUELSEAL FASTENERS, INC.	13
A	AIRFASCO, INC.	13













SYMBOL	COMPANY NAME	PAGE
	ALLIED NUT & BOLT CO., INC.	16
	ALPHA MACHINING PRODUCTS & DEVELOPMENT	17
A	ALPS SEIKO CO.	18
	AMANDA BENT BOLT CO.	18
	AMERICAN ELECTRIC and THOMAS & BETTS CORPORATION	19, 225
	AMERICAN INTERNATIONAL AERO MFG INC	19
	ANDERSON FORGE & MACHINE	21
	A-ONE MACHINE COMPANY	22
A	ARNOLD UMFORMTECHNIK GMBH & CO. KG	27
	ARROW SCREW & MACHINE WORKS	27
	ASAHI SREWS MANUFACTURING CO., LTD	28
A	ASAI TEKKO CO. LTD	28
	ASSOCIATED TOOL CO., INC	29
A	BELL FASTENERS	38
A	CAMCAR DIVISION OF TEXTRON INC.	50
	EATON AEROQUIP CORPORATION	77
	GARCIA INDUSTRIES, INC.	97
A	PORTSMOUTH NAVAL SHIPYARD	181
	ALL AUTOMATICS	15
AAP	AVIBANK MFG., INC.	32
AB	ABSCOA INDUSTRIES	3
	ADJUSTABLE BUSHING CORP	6
	AUTO BOLT CO.	30
AB	AVIBANK MFG., INC.	32
	LENCH, THOMAS WILLIAM, LTD.	135
	PRECISE OF CALIFORNIA	182
	ALPHA BOLT CO.	17
ABE	ADAMS INDUSTRIES, INC.	7
ABM	AEROBOLT MANUFACTURING, INC	9
	AUTO BOLT CO.	30

















MIL-HDBK-57J (GS7)
INDEX B

SYMBOL	COMPANY NAME	PAGE
AC	ACRODYNE MFG CO.	6
	ACE PRECISION INDUSTRIES, INC.	5
ACI	ACI	6
	ACIMET MFG.	6
	ACCU-TECH MANUFACTURING AND SUPPORT, INC	5
ACS	AMERI-CUT SOLUTIONS	18
AD	ADOM ENGINEERING	7
AD	AUTOMATIC SCREW MACHINE PRODUCTS COMPANY	31
ADB	AVIBANK MANUFACTURING, INC.	32
ADBB	AVIBANK MANUFACTURING., INC.	32
AD&M	AMERITECH DIE & MOLD SOUTH INC.	20
adm	ADOM ENGINEERING	7
	AERO DYNAMIC MACHINING, INC	9
ADP	AVIBANK MANUFACTURING., INC.	32
adc	ADC COMMUNICATIONS CORP.	7
AE	A & E MACHINED PRODUCTS	1
	AASTRO ENGINEERING	3
	AERO ENGINEERING AND MANUFACTURING CO. OF CALIFORNIA	9
	PENN ENGINEERING & MANUFACTURING CORP.	177
AEP AEP	AIRCRAFT ENGINEERING PRODUCTS, INC.	13
	AERO BUSHING AND COMPONENT	9
	ACCUFORM, INC.	4
	ACCURATE THREADED FASTENERS, INC	4
AF	ACUFAST AIRCRAFT PRODUCTS	7
	AEROTECH FASTENERS, INC	12
	AKKO FASTENER, INC.	14
	ALLFAST FASTENING SYSTEMS, INC.	16
	ALPHA FASTENERS COR.	17
AF	ANKIT FASTENERS PRIVATE LIMITED	21
	ATF, INC.	29
	AUGUST FRIEDBERG GMBH	30
	AFAB PRECISION MACHINING	12



















SYMBOL	COMPANY NAME	PAGE
AFC	AIRFASCO, INC.	13
	AIRFASCO, INC.	13
	AMERICAN FASTENER & SPECIALTY CO.	19
AGC	ACE GRINDING & MFG. OF TEXAS	5
	A.G.H. INDUSTRIES, INC.	2
AGM	ACE GRINDING & MFG. OF TEXAS	5
	AIRFRAME INTERNATIONAL, INC.	14
AI	AIRFASCO INDUSTRIES FASTENER GROUP	14
AI	PLATE NUT	
A	ON ONE SIDE	
I	ON OPPOSITE SIDE	
	HEX NUT	
A/I	ARVAN, INC.	28
	ATHENA INDUSTRIES	29
A-I	AVIBANK MANUFACTURING., INC.	32
	AIR-COM, INC.	13
AKC	MOSE ENGINEERING AND MANUFACTURING INC.	160
	AJ ASSOCIATES MANUFACTURING & ENGINEERING COMPANY, INC	14
AK	ARNOLD KNIPPING GmbH	27
A-K	AVIBANK MANUFACTURING., INC.	32
A.L.	S.A.B.A. S.p.A. BULLONERIA E. AFFINI	200
	ALPINE MACHINE & TOOL CORP.	17
	AIR LAND TURBINE SERVICES, INC	13
A & M	A & M AEROSPACE, INC.	1
	AeroMed Precision, LLC	10
AM	AEROSPACE MANUFACTURING	10
	AMACON CORP.	18
	AMERICAN FASTENER & SPECIALTY CO.	19
	AMMAC, INC.	21
	ARDOR MFG. INC.	25
	ATOMATIC MANUFACTURING COMPANY	30
AM	AUTOMATED MANUFACTURING	31
	AUTOMATIC MACHINING AND MFG CO	31
AMATOM	AMATOM ELECTRONIC HARDWARE	18
AMB	AMERICAN METAL BEARING COMPANY	19













MIL-HDBK-57J (GS7)
INDEX B

SYMBOL	COMPANY NAME	PAGE
AMC	ALBAR MACHINE CORPORATION	15
 	SAI INDUSTRIES CORP.	202
	AME SWISS MACHINING LLC	18
AMI LOGO	A.M.I ENGINEERING	2
AMP	AEROSPACE MACHINE PRODUCTS	10
	ALARD MACHINE PRODUCTS	14
	ANTRIM MACHINE PRODUCTS	22
	AERO MECHANICAL FASTENING SYSTEMS	9
AMS	AEROSPACE MARINE SPECIALTY FASTENERS & FITTINGS INC.	11
AMSCO	ACCURATE SCREW MACHINE CO	4
AMT	ADVANCED MACHINING & TOOLING, INC.	8
AMT-1 AMT xxxx-xxxx	ALPINE MACHINE & TOOL CORP.	17
A-N	AVIBANK MANUFACTURING, INC.	32
	A & N PRECISION INDUSTRIES	1
	AMERICAN QUALITY MFG. INC.	20
AOL	ALL MANUFACTURERS INC.	15
AOL	ITT HARPER AEROSPACE FASTENER OPERATIONS	120
AP	ACCURATE AUTOMATIC PARTS CO	4
ap	ADVANCED PLASTICS, INC.	8
AP	AEROSPACE PRODUCTS CO.	11
	AIR PARTS MFG. CO.	13
	AIRDROME PARTS CO.	13
AP	ALL-POWER MFG. CO.	16
AP	ALL-PRO FASTENER & RIVET MFG. CO.	16
	ANATASE PRODUCTS	21
AP	APEX MFG. CO. INC.	22
AP	APHEONIX CORPORATION	22
A-P	AVIBANK MANUFACTURING, INC.	32
	PILGRIM SCREW CORP.	180
APCO	AEROSPACE PRODUCTS	11
	APEL LTD.	22
APMI	A. P. MILLS INDUSTRIES FOR THE BLIND and WEST TENNESSEE LIONS BLIND IND. INC.	2, 243
APP	ALLIED PRECISION PRODUCTS, INC.	16

















SYMBOL	COMPANY NAME	PAGE
	ATLANTIC PRECISION SPRING, INC.	30
AR	A & R MFG CO INC	1
	ACME RIVET & MACHINE CORP.	6
ARVAN, INC.	ARVAN, INC.	28
	A & S PIN PRODUCTS INC.	1
	AEROSTAR ENGINEERING & MANUFACTURING COMPANY	11
	ALL-STATES INC.	16
AS	AVIBANK MFG., INC.	32
ASA	A.S. AEROSPACE, INC.	2
ASC ASC	ARCO SALES CO.	23
	ASL MANUFACTURING INC.	28
ASP	ATLAS SPECIALTY PRODUCTS	30, 65
ASP	CURTIS PRESTON ENTERPRISES INC.	30, 65
	ARTISAN SPECIALIST TECH, INC.	28
	AST ASSOCIATES, INC.	29
ATBO	ARMSTRONG ATLAS BOLT	26
ATLAS		
ATLROD	ATLANTA ROD & MANUFACTURING	29
	AURORA DEFENSE GROUP	30
	AVDEL INTERNATIONAL	31
AV	AVIBANK MFG., INC.	32
	AUTO-VALVE, INC.	31
AVIBANK	AVIBANK MFG., INC.	32
AVK	AVIBANK MFG., INC.	32
	AVK INDUSTRIES PRODUCTS INC.	32
AVL	AVIBANK MFG., INC.	24
	A & W SCREW MACHINE PRODUCTS, INC	2
	AIW-ALTON INC.	14
	ARNOLD WRAGG (BOLTS & NUTS) LTD	27
A-W	AVIBANK MFG., INC.	32
AX	AEROMAX INDUSTRIES, INC.	10
AXL 	AXIAL GLOBAL, LLC	32
AZAD 	AZAD ENGINEERING VT LTD	32











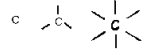
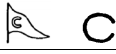



MIL-HDBK-57J (GS7)
INDEX B

SYMBOL	COMPANY NAME	PAGE
B		
	B & E MACHINE SHOP & SHEET METAL FAB., INC.	33
	B & E MANUFACTURING CO., INC.	33
B	BELL FASTENERS	38
	BELL-MEMPHIS, INC.	39
	BERGNER, RICHARD GMBH & CO	39
	BETA ENGINEERING, INC.	40
	BLANC AIRCRAFT FASTENERS, INC.	41
	BOBCAT MANUFACTURING CO.	42
	BOLT FASTENER STUD/TECHNOLOGY	42
B B+ B1	BRISTOL INDUSTRIES	44
	BROADSTONE TOOL & DIE, INC.	45
b	BRYNOLF MANUFACTURING, INC.	46
	BUCK EYE FORGE, INC.	46
BALL-LOCK	AVIBANK MFG., INC.	32
	BEL-AIR MACHINE & PERFORMANCE	38
	BARRE PRECISION PRODUCTS INC.	35
BAF	BLANC AIRCRAFT FASTENERS, INC.	41
BAI	BRILES AEROSPACE, INC.	44
BB	B & B SPECIALTIES, INC.	33
	BARNEGAT BAY NSCC, INC. DBA BB NSCC, INC.	35
BB BB	BIG BOLT CORP.	40
BB BB BB • • •		
	LISI AEROSPACE	140
	B&B ELECTRO-MECHANICAL	33
	BETA CORP.	40
BCC	BBC FASTENERS, INC.	36
BD BDM	SAFETY SOCKET SCREW CORP.	201
BDM	BRUNNER DRILLING & MFG. CO., INC.	45
	BOGNER ENGINEERING CO.	42
	BARCO ENGINEERING COMPANY, INC.	35
BEC	BEC MACHINE PRODUCTS	36

SYMBOL	COMPANY NAME	PAGE
BEI	ANOTHER SCREW MACHINE PRODUCT	22
	BOMAR ENGINEERING, INC.	43
BEK	BEK LEVEL 1 FASTENERS and LEVEL 1 FASTENERS	37,137
	BENACO TOOLING RESEARCH & DEV. CORP.	39
BFG+	B F GOODRICH CO. RIVNUT ENGINEERED FASTENERS, THE	34
BFI	BRIARWOOD FASTENERS, INC.	43
	B G ENGINEERING, INC.	34
	B G M FASTENER CO., INC.	34
BH	BULTEN TRADING AB	47
BI	BEE INDUSTRIES, INC.	37
BI	BRISTOL INDUSTRIES	44
	BRINTCLIFFE TURNER LTD.	44
BIM	BUSAN INDUSTRIAL MACHINERY CO., LTD.	47
BL	BLAND CO., THE	41
BL	BRIGHT LIGHTS USA, INC.	44
BLC	AVIBANK MFG., INC.	32
BLSAVIBANK	AVIBANK MFG., INC.	32
	BEACH MACHINE	36
BM	BERRY, JOHN DBA BERRY MANUFACTURING	40
BM	BERRY MANUFACTURING	40
BM	BRUNNER DRILLING & MFG. CO., INC.	45
BM	BRUNNER MANUFACTURING CO. DBA BRUNNER MANUFACTURING DIVISION	46
BM	BRYCO MACHINE, INC.	46
BM	BUSAN INDUSTRIAL MACHINERY CO., LTD.	47
BMC INC.	BRACELENTE MANUFACTURING CO., INC.	43
	BUCKEYE MACHINING, INC.	46
	BRADY MACHINE, INC.	43
	BRANCH MACHINE PARTS, INC.	43
	BOLT & NUT CO.	42
	BONEAL INC.	43
	B & N TOOL CO., INC.	34
	FRIEDR BOESNER GMBH	95
BOT	BEOTOOL CORP.	39

MIL-HDBK-57J (GS7)
INDEX B

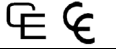
SYMBOL	COMPANY NAME	PAGE
BP	BELL PRECISION, INC.	39
BP	BUFFALO PUMPS, INC.	46
B.P.C.	BEAVER PRODUCTS CORP.	36
BPG	FERRY CAP & SET SCREW CO., THE	91
	BROWN PRODUCTION, INC.	45
	BER-LOW MFG INC.	40, 47
	BUTECH PRESSURE SYSTEMS	40, 47
BR	B & R MACHINE AND TOOL CORP	34
	BRIDEAN MACHINE & TOOL CO., INC.	43
	BURROWERS RESEARCH MACHINING, INC.	47
BSM	BAY SWISS MANUFACTURING	36
	BROADWAY SCREW MACHINE INC.	45
BT	BEGONIA TOOL COMPANY	37
	BLAINE TOOL CORP.	41
	BAS AEROSPACE LIMITED	35
BUFO	BULTEN TRADING AB	47
BULA	BULA FORGE INC.	47
	BOLTWORKS, INC.	42
BVB	BRIDGEVIEW MANUFACTURING CO.	44
B _X	ITW BUILDEX	120
BY	BEN YUAN ENTERPRISE CO, LTD.	39
	EBERHARD BRUNINGHAUS	78
	C	
C 20-1	CENTRIX, INC	57
C&D MACH	C & D MACHINE TOLL, INC.	48
C	CARDINAL INDUSTRIAL PRODUCTS	54
	CDS MACHINE INC.	55
	CEREBRUS CORPORATION	58
	CETIN CIVATA SANAYI VE TICARET A.S.	58
	CHAMPION FASTENERS, INC.	58
	CHANCE, A.B. COMPANY	58
	CHIEF MFG.	60
	CINCH MANUFACTURING	60
C	CNC MACHINING INC.	61

















SYMBOL	COMPANY NAME	PAGE
	COAAEE BOLTS WORKS CO., LTD.	61
	COAST INDUSTRIAL SUPPLY CO., INC	61
	CO-OP SCREW MANUFACTURING CORP.	63
	CSM FASTENER PRODUCTS	65
	HAZE SEIKO CO., LTD.	106
	SPS TECHNOLOGIES	213
	TEXTRON FASTENING SYSTEMS	224
	TOWNSEND CO.	227
CA	C & A MACHINE CO.	48
CA	CUMMINS AEROSPACE (YEAGER MANUFACTURING CORP.)	65,249
CAL	BAY BOLT	35
CAMCAR	CAMCAR DIVISION OF TEXTRON INC.	50
CAMCAR	CAMCAR LLC	53
	ALCOA FASTENING SYSTEMS & RINGS, ARCONIC FASTENING SYSTEMS & RINGS, CAMLOC FASTENER CORPORATION, REXNORD	15, 23, 53, 194
	CAM-TECH INDUSTRIES	53
	CONNECTICUT AIRCRAFT PRODUCTS	63
	CAVALIER BOLT & NUT, INC	55
	BOBCAT MANUFACTURING CO.	42
CB	CLICK BOND, INC.	60
CBM	COMPUTA-BASE MACHINING, INC.	63
CBS	CBS FASTENERS INC.	55
CbS		
CCB	CCB INDUSTRIES, INC.	55
CCF	CCF ENTERPRISES INC.	55
CCG	CORPUS CHRISTI GASKET & FASTENER LTD.	64
CCS	SPS TECHNOLOGIES	213
	CAPRICE ENGINEERING CO., INC.	54
C. E. I	COMMAND ENTERPRISES	62
CES	C. E. S. MACHINE PRODUCTS, INC	48
	CHICAGO FASTENER MANUFACTURING	59
CFL	CLYDE FASTENERS LIMITED	61
CFS	CARDINAL FASTENER & SPECIALTY CO., INC.	54









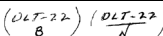

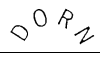

MIL-HDBK-57J (GS7)
INDEX B

SYMBOL	COMPANY NAME	PAGE
	CORPUS CHRISTI GASKET & FASTENER LTD.	64
	CANADY MANUFACTURING CO. INC.	53
	CHU HUA INDUSTRIAL CO., LTD.	60
	COLD HEADING CO., THE	62
CHEREK	CHEREK MACHINE & TOOL CO., INC.	59
CHF	CHICAGO HARDWARE & FIXTURE CO.	59
CI	CATALINA INSTRUMENT CORPORATION	55
	CENTENNIAL BOLT, INC.	56
	SPS TECHNOLOGIES	213
	C. J.'S GENERAL MACHINE WORKS	49
	CENTERLINE TOOL & ENGINEERING, INC.	56
CM	CER-MAC INC.	Error! Bookmark not defined
	CM MANUFACTURING, INC.	61
	CRESCENT MANUFACTURING CO.	64
	CERNY MFG. CO.	58
	CHRIS MACHINE CO.	60
CMI	CONQUEST MACHINE, INC.	63
	CENTURY METAL PARTS CORP.	57
	CONTINENTAL MACHINE PRODUCTS, INC.	63
CMT	CMTECHTOOLS, LLC	61
CNB	CHICAGO NUT & BOLT INC.	59
	CRYSTAL METAL PRODUCTS COMPANY, INC.	65
	CAPY MACHINE SHOP, INC.	54
	OWARI PRECISE PRODUCTS CO., LTD	172
	CENTRAL OZARK MACHINE, INC.	57
	COPELAND MFG. CORP.	64
CP	CHANDLER PRODUCTS, INC.	58
CPI	CREATIVE PRECISION INC.	64
CPM	CHOICE PRECISION MACHINE, INC.	60



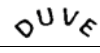









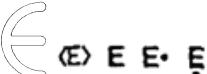

SYMBOL	COMPANY NAME	PAGE
	CHEMIQUIP PRODUCTS COMPANY	59
	C.R.D. MACHINING	49
CRUM	CRUM MFG	65
	CRS PRECISION CORP.	65
	C & S ENGINEERING LLC	48
CS C S	CALIFORNIA SCREW PRODUCTS CORP.	49
	COPPER STATE BOLT & NUT CO.	64
	CAMBRIDGE SPECIALTY COMPANY, INC.	50
C S D	CAMCAR DIVISION OF TEXTRON INC.	50
C-SI	CALABRESE & SONS, INC.	49
	CENTRAL SCREW PRODUCTS	57
	CHEROKEE TOOL & ENGINEERING CO., INC.	59
CTM	CONTINENTAL TOOL & MANUFACTURING	63
CTeXD	CEN TEX DEFENSE INDUSTRIES	56
C W R C	CWR MANUFACTURING CO	66
D		
	DDM SUPPLY LLC	67
	D & D MANUFACTURING	66
D & D	D & D TOOL COMPANY, INC.	66
	B & D THREADED ROLLING	33
	DACK INDUSTRIES, INC.	67
	DANIEL CO., EDWARD W.	68
D	DAN-LOC BOLT & GASKET INC.	68
D	DECKER MANUFACTURING CORP	69
	DEFIANCE STAMPING COMPANY, THE	70
D	DEHOUSSE (USINES)	70
	DELL MFG. CO., INC.	70
D	DEMAT	71
	DERBYSHIRE MACHINE & TOOL CO.	71
D	DIESEL PARTS COMPANY OF CALIFORNIA	72









MIL-HDBK-57J (GS7)
INDEX B

SYMBOL	COMPANY NAME	PAGE
D	DIHARD COMPANY	72
	DIVERSIFIED FASTENING SYSTEMS, INC.	72
	DO MANUFACTURING CORP.	73
	DUPONT, G.B. CO., INC. and KAMAX L. P.	75, 96, 125
	DUSEVOIR METAL PRODUCTS, INC.	75
D	DUVE GmbH & CO. KG	75
	DYSON CORP, THE	76
	ONTIC ENGINEERING & MANUFACTURING, INC.	171
	STEEL WAREHOUSE COMPANY, INC.	216
D A E	DAVE ALLEN ENTERPRISES	68
DAS 1	DEFENSE AEROSPACE	70
	DILLON AERO, INC.	72
DABS	DABS M&A, LLC	67
	DAYMAK SU DEPOSU IMALAT MAKIN INSAAT TAAHHUT TURIZM GIDA VE DIS TIC. LTD. STI.	69
DB	DAN-LOC BOLT & GASKET INC.	68
DC	D. C. MACHINING INC.	67
DDG	BLANC AERO INDUSTRIES and LISI	140
	DYNAMIC ENGINEERING	76
DF™	DEUTSCH FASTENER CORPORATION	71
	DTF MANUFACTURING, INC.	74
	DFCI SOLUTIONS, INC.	72
	DETROIT HEADING CO.	71
DHL	DHL ENTERPRISES	72
	DIAL SUPPLY AND MANUFACTURING, INC.	72
	DELTA INDUSTRIES, INC.	70
DI	DUNCAN ELECTRONICS & MFG. CO	75
	DOMESTIC FORGING, INC.	73
DL	DISC-LOCK INTERNATIONAL	72
	MILLS, J. R. MACHINING, INC.	156













SYMBOL	COMPANY NAME	PAGE
DMC	DECKER MANUFACTURING CORP	69
	DEPENDABLE MACHINE CO., INC.	71
DMC	DONSON MACHINE	73
	DELTA MACHINE & TOOL CO., INC.	71
DMT	DIXON MACHINE & TOOL and TROY D. RAY	73, 229
	KNIPPING-DORN GmbH	128
	TRW	229
D P	DARCO PRODUCTS	68
DP	DUNHAM PRODUCTS, INC.	75
DPI	DUNHAM PRODUCTS, INC.	75
DPM	DAVIES PRECISION MACHINING, INC.	68
	DEFENSE QUALITY MFG.	70
	DOUBLECO INCORPORATED	74
	DEMAT	71
DTE	DOUGLASS TOOL & ENGINEERING CO., INC.	74
DTE	EMERALD VALLEY MFG	80
	DTF MANUFACTURING, INC	74
	DUFFY ELECTRONICS & MFG. CO.	75
DUVE 	DUVE GmbH & CO. KG	75
DUVEX	DUVE GmbH & CO. KG	75
DV	DEL-VAL FASTENER MANUFACTURING	71
DX	DUVE GmbH & CO. KG	75
DYNACAST	DYNACAST	75
DZUS 	DZUS FASTENER CO., INC.	76
E		
	EAGAN MACHINE CORP.	76
E	EAST COAST METALS INC.	77
	EASTERN SCREW CO., INC.	77
E	EBC INDUSTRIES (ERIE)	77, 83



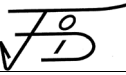







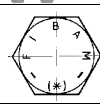

MIL-HDBK-57J (GS7)
INDEX B

SYMBOL	COMPANY NAME	PAGE
E	ERIE BOLT CORP.	77, 83
E	ELASTIC STOP NUT & ESNA	78, 84, 146
E	ELCO INDUSTRIES, INC.	78
e 	ELLIS PRECISION INDUSTRIES	80
E	ENGINEERING MATERIALS CO., INC.	82
	ENOMOTO INDUSTRIES CO., LTD.	83
E  E E E	ERICO FASTENING SYSTEMS	83
	ESMET, INC.	83
E	NORTHBRIDGE FASTENERS	167
	R B & W CORPORATION	189
E A	VOSS INDUSTRIES, INC.	241
 EARTH	SUPERIOR TECHNOLOGY	220
	EAST BAY MANUFACTURERS, INC.	77
EBM	EBERHARD BRUNINGHAUS	78
EBP	ENGINEERED BOLTING PRODUCTS, INC.	81
	ELITE FASTENERS	79
	ELGIN FASTENER GROUP LLC	79
	ENDURALOCK, LLC	81
	ELCO INDUSTRIES, INC.	78
	INFASTECH DECORAH LLC.	118
	E.L.R. MACHINE AND TOOL	76
E M	EASTWOOD MFG., CO.	77
 EM	ENGEL MANUFACTURING COMPANY, INC., THE	81
EM	ENGLE MANUFACTURING COMPANY, INC., THE	81
	ESSENTIAL MACHINING	84

SYMBOL	COMPANY NAME	PAGE
	EXPERIMENTAL MACHINE CO.	85
EN	ELASTIC STOP NUT & ESNA	78, 84, 146
Ep	EAGLE PICHER INDUSTRIES	76
	EMPIRE PRECISION MACHINING and MD3 INDUSTRIES LTD.	81, 151
EPI	ESCO PRECISION, INC.	83
ERIE	EBC INDUSTRIES (ERIE)	77, 83
ERIE	ERIE BOLT CORP.	77, 83
ESC	ECENARRO S. COOP. LTDA	78
ESNA	ELASTIC STOP NUT & ESNA	78, 84, 145
	EXTREME PRECISION SCREW PRODUCTS, INC	86
ESTA	ESTA PRODUCTS COMPANY	84
ET	AVIBANK MFG., INC.	32
ETC	AVIBANK MFG., INC.	32
ETI	ENVISION TECH, INC.	83
159	ELEIT TECHNOLOGT, INC.	79
$E \Sigma \Pi$	ESP MANUFACTURING CO., INC	84
EWB	SPS TECHNOLOGIES	213
EWN	SPS TECHNOLOGIES	213
	PRECISE OF CALIFORNIA	182
F		
F593	ENGLE MANUFACTURING COMPANY, INC., THE	83
F	AVIATION MANUFACTURING GROUP LLC (SEE DBA FREEMAN CO., THE)	32, 95
	BLUE TEE CORP DBA GEFCO/ STECO	41
	FAILING CO., GEORGE E	86
f fr	FALL RIVER MANUFACTURING CO., INC.	87
	(FASSCO) FASTENER & STEEL SUPPLY CO., LTD.	87
F F	FASTENRATH BEFESTIGUNGSTECHNI K GmbH	89
F	FASTI-WERK CARL AUG. FASTENRATH GMBH & CO.KG	89
F	FASTRON COMPANY, THE	90
  F	FEDERAL SCREW WORKS	90

MIL-HDBK-57J (GS7)
INDEX B

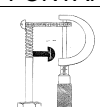
SYMBOL	COMPANY NAME	PAGE
	FENBAR PRECISION MACHINISTS, INC.	91
	FERNDAL FASTENER	91, 195
F	FREEMAN CO.	32, 95
	LISI AEROSPACE, MONADNOCK COMPANY, THE	140, 159
	M & M MANUFACTURING CORPORATION	143
F	VISSERIES & BOULONNERIES DE FOURMIES	237
F 2F 3F 4F 5F	FONTANA LUIGI S.p.A.	94
	THIANT (BOULONNERIE DE SA)	225
FAH	FRISBY AEROSPACE INC DE and TRIUMPH GROUP OPERATIONS INC, THE	95, 228
FB	PRECISION MACHINING COMPANY	183
	FRONTIER BOLT COMPANY OF TEXAS	95
FC F-C	FERRY CAP & SET SCREW CO., THE	91
	FUCHS SCHRAUBENWERK GmbH	96
FCI	FONTAL CONTROLS, INC.	94
FDC	FLUIDYNE CORPORATION	93
FDI	FASTENER DIMENSIONS, INC.	88
		
	FABER ENTERPRISES, INC.	86
	FABSCO CORP.	86
	FLORES ENTERPRISES	93
F E C	FEDERAL EQUIPMENT COMPANY	90
6 0 5 8 7		
	FOREST FASTENERS	94
	FORMED FASTENER MANUFACTURING, INC.	94
F.K	VISSERIES & BOULONNERIES DE FOURMIES	237











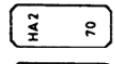
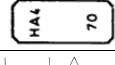

SYMBOL	COMPANY NAME	PAGE
FH	FOCUS HOPE	93
FH	FOCUS HOPE	93
	FLAIG & HOMMEL	92
	FENTON HEADING	91, 195
	FASTCO INDUSTRIES, INC.	88
	FIBAM COMPANHIA INDUSTRIAL	91
FIT	FASTENER INNOVATION TECHNOLOGY, INC.	88
	FLUIDONICS INC.	93
FM	FREEHOLD MFG ASSEMBLY CO., INC	95
	FALCON MANUFACTURING CORP.	86
	FOLSOM TOOL & MOLD CORP.	93
F M C	FEDERAL MANUFACTURING CORP.	90
	TRIAD PRODUCTS CORP.	228
FME 	COLTEC INDUSTRIES, INC. dba FAIRBANKS MORSE ENGINE	62
	FMW, INC.	93
FN	AVIBANK MFG., INC.	32
FNF	SPS TECHNOLOGIES	213
	FASTENAL COMPANY	88
FONTANA	FONTANA LUIGI S.p.A.	94
	FASTENING PRODUCTS OF LANCASTER, INC.	89
FPA	FPA MANUFACTURING	94
	FASTENING PRODUCTS CO., INC.	89
FPF	FLIP PERILLO FASTENER, INC.	92
FPIC	FOREMOST PRECISION INSTRUMENT CORP.	94
fr	FALL RIVER MANUFACTURING CO., INC.	87
F.R.	FRANROE PRECISION MACHINE COMPANY	95
FRIEDBERG	AUGUST FRIEDBERG GmbH	30

















MIL-HDBK-57J (GS7)
INDEX B

SYMBOL	COMPANY NAME	PAGE
F.R.P	FRANROE PRECISION MACHINE COMPANY	95
FS	FABRICATION SPECIALTY INC.	86
F S	FERRIERE DI STABIO, S.A.	91
FS	FLAIG & HOMMEL	92
f t	CAMCAR DIVISION OF TEXTRON INC.	50
FT	FASTENER TECHNOLOGY CORP.	89
FTZ	FITZ MANUFACTURING INDUSTRIES	92
	FUCHS SCHRAUBENWERK GmbH	96
FUN	FASTENERS UNLIMITED INC.	89
FX	FLEXALLOY INC.	92
G		
G	EVERLOCK FASTENING SYSTEMS	84
G	GALAN PRECISION MACHINE CO.	97
	GALMAC MFG CO.	97
G	GATEWAY SCREW AND RIVET, INC.	97
	GENERAL MACHINE PRODUCTS, INC	98
	GILL MACHINE & TOOL CO.	98
G	GOSHO WORKS, LTD.	99
	GRACO INDUSTRIES, INC.	99
G	GREER STOP NUT	85, 101
	GUARDIAN RIVET & FASTENER	103
GAI	GATES ALBERT INC.	97
	GARDINER MFG. CO.	97
	G. B. MACHINE PRECISION, INC.	96
	STERLING MARKING PRODUCTS IC.	218
	GRAUCH ENTERPRISES	100
GEBI	J. GEORG BIERBACH	121
GF	GRANDEUR FASTENERS, INC.	100
Gf	GRIPCO, DIVISION OF BLACK & DECKER	101
GFM	GREENFIELD MANUFACTURING CO., INC.	100
GFX	GULF FASTENER, INC.	103
Gh	EMHART CORP.	80











SYMBOL	COMPANY NAME	PAGE
GII	GERTLER INDUSTRIES, INC.	98
	GL CNC SERVICE INC.	98
GLC 1		
GMF	GAITHER MACHINE	96
	GMJ MACHINE COMPANY, INC.	99
GMT	GREATER MARYLAND TOOL & MFG., CORP.	100
	GRIPCO, DIVISION OF BLACK & DECKER	101
Go	GOSHO WORKS, LTD.	99
Gosho	GOSHO WORKS, LTD.	99
G-P	GROOV-PIN CORPORATION	102
GPM	GALAN PRECISION MACHINE CO.	97
G&R	G & R SCREW MACHINE PRODUCTS	96
GR	RABOURDIN	190
	GERMAN MACHINED PRODUCTS, INC.	98
GRMN 6		
GS	B & B SPECIALTIES INC. and GS AEROSPACE TECHNOLOGY, INC.	33, 102
G-S	G & S MACHINE INC.	96
GS	GENERAL SCREW & SPECIALTY CO., INC.	98
GSAT	GS AEROSPACE TECHNOLOGY, INC.	102
GSF	ARMSTRONG PRECISION COMPONENTS LTD.	27
GSF	GSF FASTENING	102
GSI	GS AEROSPACE TECHNOLOGY, INC.	102
	SCHRAUBENFABRIK GUSTAV STERNBERG GmbH & CO. KG	203
GTT	GUNNISON-INTERNATIONAL INC.	103
H		
H	BEK LEVEL 1 FASTENERS and LEVEL 1 FASTENERS	38, 137
	FUCHS SCHRAUBENWERK GmbH	96
	HAMANAKA (THAILAND) CO., LTD.	104
H	HASKELL OF HUNTINGTON, INC	105
h	HAYDON BOLTS, INC.	106
	HEMCO TOOL INC.	107
H	HEXAGON ENTERPRISES, INC.	108
	HILL FASTENER CORP.	109
H	HILTI, INC	110







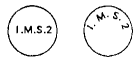
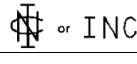



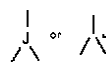

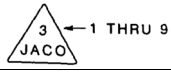

MIL-HDBK-57J (GS7)
INDEX B

SYMBOL	COMPANY NAME	PAGE
H  	HI-SHEAR CORP. (LISI)	110, 140
H	HOFFMANN, RICHARD GMBH CO. KG	111
H	HOLLYWOOD MANUFACTURING INC.	112
H	HUCK PRODUCTS, ALCOA FASTENING SYSTEMS & RINGS, ARCONIC FASTENING SYSTEMS & RINGS	95, 15, 23
H	HUGGINS MFG.	114
H	HURON AUTOMATIC SCREW CO.	115
 H	MNP CORPORATION	159
 	FUCHS SCHRAUBENWERK GmbH	96
	HABINA ENGINEERING	104
	HARTFORD AIRCRAFT PRODUCTS, INC.	105
	HARRISON BOLT & NUT CO., THE	105
HB	HYDROBOLT LIMITED	115
HBN	MNP CORPORATION	159
HBW	HAWTHORNE BOLT WORKS	106
HC	H C MERCHANDISERS INC. and H C PACIFIC	103
HCP	H C MERCHANDISERS INC. and H C PACIFIC	103
 HD	HUGO DURHOLT GMBH & CO. KG	114
HDI	HARWOOD DESIGN, INC.	105
HE HE	HORST ENGINEERING & MANUFACTURING CO.	112
HEM	HORST ENGINEERING & MANUFACTURING CO.	112
	HILL FASTENER CORP.	109
HF	HYDRO FITTING MFG. CORP.	115
 A	HG AEROSPACE ENGINEERING LTD	108
 HHW	HO HONG WORKS CO., LTD	111
HI	HOLAN, INCORPORATED	111
	HI INDUSTRIAL TECHNOLOGIES	108
HIC	HALLSIMS INDUSTRIAL COMPONENTS, INC.	104
 HILL	HILL AEROSPACE & DEFENSE LLC.	109
HILTI	HILTI, INC	110
HI PSI	SPS TECHNOLOGIES	213
HI TI	SPS TECHNOLOGIES	213
	HO-HO-KUS, INC.	111









SYMBOL	COMPANY NAME	PAGE
HK HK H-K	HOLO-KROME CO.	112
HL	HLC INDUSTRIES INC.	110
HM	H. MULLINS, LTD.	103
	HOWIE MANUFACTURING CO., INC.	113
	HEIM'S MACHINE & TOOL, INC.	107
HMTC	HOWE MACHINE AND TOOL CORP.	113
	CAMCAR DIVISION OF TEXTRON INC.	50
	CAMCAR SCREW AND MFG CO	53
 	H. PRINZ GmbH	104
HP 	HENWAY, INC.	107
	HIGHLAND PRODUCTS CORPORATION	109
HP	HOWELL PRECISION, INC.	113
	MICRO SCREW MACHINE PRODUCTS, INC.	154
HPF	HOUSTON PRECISION FASTENERS	113
HPS	HILTI, INC	110
HQ	HIGH QUALITY MACHINE SHOP	108
HR HR	HORSPOOL & ROMINE MANUFACTURING CO., INC.	112
	HARDWARE SPECIALTY CO, INC	105
HS	HILL STAMPING & MFG., INC.	109
hs HS hs	HI-SHEAR CORP.	110, 140
hs	LISI AEROSPACE	140
HSC	HUNTER STEVENS COMPANY	114
HSLG-R	HILTI, INC	110
	HAMANAKA (THAILAND). CO., LTD.	104
	HIGHLAND THREADS, INC.	109
	HOWARD TOOL CO., INC.	113
HTC	HEITCO MANUFACTURING, INC.	107
HTE.	HIGH TECH ENTERPRISES	108
	HATCH INDUSTRIES	106
	HUNT VALVE COMPANY, INC.	114
HVI	HUNTINGTON VALLEY INDUSTRIES, INC. DBA HVI	115
I	ALPHA BOLT CO.	17
 	EVERLOCK FASTENING SYSTEMS	84

















MIL-HDBK-57J (GS7)
INDEX B

SYMBOL	COMPANY NAME	PAGE
	IMPERIAL SUPPLIERS, INC.	116
I	INDUSTRIAL & AUTOMOTIVE FASTENERS	117
	INFASTECH DECORAH LLC.	118
	INTERSTATE FITTINGS INC.	119
	PIONEER SCREW & NUT CO.	180
IA	INCO TECH AEROSPACE FASTENERS, INC.	116
IA	INDIANA AIRCRAFT HARDWARE	116
IAH	INDIANA AIRCRAFT HARDWARE	116
IF	IDEAL FASTENERS INC.	115
IF	INDUSTRIAL FORGE, INC.	117
IFORM	INFASTECH DECORAH LLC.	118
	I.G.D. MACHINE & TOOL LTD.	115
	STERLING MARKING PRODUCTS IC.	218
II	MACLEAN-FOGG CO.	146
	JUNIPER ELBOW CO.	124
III	COLOC MANUFACTURING	62
	CAMCAR DIVISION OF TEXTRON INC.	50
IM IM IM	INLAND MACHINE CO. INC.	118
IM	IRVING MACHINE SERVICE, INC.	119
	INTERFLEX MFG. CORP.	119
IMG	IRON BOUND MANAGEMENT GROUP	119
	INSTRUMENT MACHINING SERVICE LTD.	119
I.M.S.2		
	INDUSTRIAL NUT CORP.	117
ICHO	AIHARA SEIBYO CO LTD	12
	ISLAND ENGINEERING DBA J. SMITH MACHINE SHOP INC.	120
IN	FASTENER BROKERAGE INC.	88
IN	INOFAST MANUFACTURING INC.	88, 119
INBUS	BAUER & SCHAURTE KARCHER GMBH	35
	IN-SPECK CORP.	119
IT	AVIBANK MFG., INC.	32
ITC	AVIBANK MFG., INC.	32
IRW	IRWIN AUTOMATION, INC.	119

SYMBOL	COMPANY NAME	PAGE
J		
J	AF FASTENERS LIMITED	12
	B & G MANUFACTURING CO., INC.	34
J	HEWINS, EDMOND, C. JR DBA JET MACHINE WORKS COMPANY	108
J	JACOBSON MFG., LLC.	122
	JANUS FASTENING SYSTEMS, INC.	123
	JJ SCREW PRODUCTS, INC.	124
J	JOSLYN CORP.	124
	JUPITER WASHERS, INC.	125
J2H	B & G MANUFACTURING CO., INC.	34
J4	B & G MANUFACTURING CO., INC.	34
	JACO ENGINEERING, INC.	122
JB	BUTLER, INC.	48
	JAY BEE MACHINE WORKS, INC.	123
JB7	B & G MANUFACTURING CO., INC.	34
JB16	B & G MANUFACTURING CO., INC.	34
	DEERE & CO.	70
JDF	NINGBO JINDING FASTENING PIECE CO, LTD	165
	JAYCO ENGINEERING, INC.	123
JEA	JEA ENTERPRISES, INC.	123
	JERGENS INC.	123
JF	ELECTRO-FREETO MANUFACTURING COMPANY	79
JG	J. G. FASTENERS	121
JH	JINN HER ENTERPRISE CO., LTD.	123
	HASSALL, JOHN, INC.	106
JI	JAMISON INDUSTRIES INC.	122
JIT	JUST IN TIME, INC.	125
	JAMES JACKSON DBA JJ ENGINEERING	122, 124
	B & G MANUFACTURING CO., INC.	34
	J & M MACHINING LLC.	121
	J.M. PRECISION, INC.	122

MIL-HDBK-57J (GS7)
INDEX B

SYMBOL	COMPANY NAME	PAGE
JNC	B & G MANUFACTURING CO., INC.	34
JOLICO	JOLICO/J-B TOOL INC	124
	JAY O MACHINE CO., INC.	123
JRB	JOHN R. BROMILEY COMPANY INC.	124
JS	B. V. FABRIEK VAN KLINKNAGELS EN SCHROEFBOUTEN V/H SMIT	35
J-S	J & S PRECISION PRODUCTS	121
<i>JT</i>	JAM TECH CORP.	122
	KARMA INC dba JEWELL TOOL TECH	126, 123
K		
K	ADI MANUFACTURING, INC	7
	KAYNAR PRODUCTS, MICRODOT INC KAYNAR TECHNOLOGIES, DIVISION OF MICRODOT, ALCOA FASTINNING SYSTEMS & RINGS, ARCONINC FASTENING SYSTEMS & RINGS	127, 155, 15, 23
K	KATSURAGAWA MACHINE SCREW CO., LTD.	126
K	KAYGOR, INC.	126
K	KEN FORGING, INC.	127
K	KILBOURN ENGINEERING CO.	128
	KEYSTONE BOLT & NUT COMPANY	128
	KEYSTONE TOOL & MACHINE CO.	128
	KNOCH MANUFACTURING CO. LTD.	129
	KOLB GMBH & CO.	129
K	KORODY COLYER CORP.	130
	KNOCH MANUFACTURING CO. LTD.	129
K	SPS TECHNOLOGIES	213
K-5673	SPS TECHNOLOGIES	213
KA	K.A.A. COMPANY	125
KAMAX	KAMAX-WERKE RUDOLF KELLERMANN GmbH & CO. KG	125
KARRO®	BAUER & SCHAURTE KARCHER GMBH	35
KDK	K.D.K. UPSET FORGING CO.	125
KE	KELLER ENGINEERING	127
k+k	K & K PRECISION ENTERPRISES	125

SYMBOL	COMPANY NAME	PAGE
	KYOKUTO MFG CO LTD.	131
KL	KLINCHER LOCKNUT CORP.	128
KLM	K.L.M. MACHINE INC.	128
 	KERR LAKESIDE INC.	127
KO	KO AMS MACHINE PRODUCTS	129
KP	KAPCO INDUSTRIES, INC.	126
	KIRSTEN PIPE CO. INC.	128
KPP	KOZAK, E. PERCISION PRODUCTS CO.	130
	KROBACH MANUFACTURING CORP.	130
	KONGO BYORA CO., LTD.	129
KNIPPING	ARNOLD KNIPPING GmbH	27
KPP	E. KOZAK PRECISION PRODUCTS CO.	76
KS	SPS TECHNOLOGIES	213
	KSS SOCKET SCREW, INC	130
  	K-TECH MFG., INC.	130
	TURNAMICS, INC.	230
KTI	KONDOR TECHNOLOGIES, INC.	129
KTM	KREIS TOOL & MFG., CO., INC.	130
KX	KAMAX-WERKE RUDOLF KELLERMANN GmbH & CO. KG	125
	KYOEI SEISAKUSHO CO., LTD.	131
L		
L	CHUN YU WORKS & CO., LTD.	60
L	L & H THREADED RODS CORP.	131
 L	LAMSON AND SESSIONS OF CANADA LTD.	133
	LANIS MACHINE & MFG., CO.	133
	LAWSON PRECISION MACHINING, INC.	134
	LINREAD NORTHBRIDGE AIRCRAFT PRODUCTS DIVISION,	138, 15, 23

MIL-HDBK-57J (GS7)
INDEX B

SYMBOL	COMPANY NAME	PAGE
	ALCOA FASTENING SYSTEMS & RINGS, ARCONIC FASTENING SYSTEMS & RINGS	
	LINREAD NORTHBRIDGE AIRCRAFT PRODUCTS DIVISION	138, 15, 23
L	ALCOA FASTENING SYSTEMS & RINGS, ARCONIC FASTENING SYSTEMS & RINGS	142
L	LONE STAR FASTENERS, LP	142
L L1	LORD CORPORATION	143
L L ⁵ L ⁸ L ⁹	R B & W CORPORATION	189
	LEE AEROSPACE PRODUCTS, INC.	134
LBS	LIGHTING BOLT & SUPPLY, INC.	138
LL	LINREAD NORTHBRIDGE AIRCRAFT PRODUCTS DIVISION	138
LL or	LONG-LOK FASTENERS CORP.	143
LAH	LENTERN (AIRCRAFT) LTD.	135
LAM	L. A. MARTIN CO.	131
L B	LANARKSHIRE BOLT LTD.	133
	LANARKSHIRE BOLT LTD. <i>Raised letters</i>	
	L & C MANUFACTURING CO., INC.	131
LC	LISI AEROSPACE	140
LE	LAKE ERIE SCREW CORP.	132
	LaMOTT ENTERPRISES, INC.	132
LE	LEP SPECIAL FASTENERS INC.	136
LE	LIPPISCHE EISENINDUSTRIE GmbH	140
LE	WOLTERS GMBH	247
LG	L G MACHINE & MFG INC.	131
LFC	LFC INDUSTRIES INC.	137
	L H INDUSTRIES, INC.	132
LI	LANA INDUSTRIES	133
	TRW	229
	L & J FASTENERS, INC.	131
L & M	L & M ENTERPRISES, INC.	131
LM	LEVINGSTON MACHINE COMPANY	137
LMC	LOUGHLIN MANUFACTURING CORP.	143
	LANUM METAL PRODUCTS, INC.	134













SYMBOL	COMPANY NAME	PAGE
L.M.T.	LANUM METAL PRODUCTS, INC.	134
	LLOYD MACHINE & TOOL CO., INC.	142
LNA	L N AEROSPACE, INC.	132
LOBO	LOBO OFFICINE MECCANICHE SPA	142
	LOBO SYSTEMS LTD	142
LONG LOK	LONG-LOK FASTENERS CORP.	143
L. P. R.	L P R PRECISION PARTS AND TOOL COMPANY, INC.	132
LRA	AVIBANK MFG., INC.	32
LRG	L R G CORPORATION	132
L.P.R.	PRECISION PARTS & TOOL CO., INC.	183
	R B & W CORPORATION	189
L-S-A	CEI INC.	55
L-S-A	LAND-SEA-AIR MACHINED PRODUCTS, INC.	133
	LEHNER SCREW MACHINE CO	134
LSF	LONESTAR FASTENERS	142
L<W>M	LITTLE WORLD MANUFACTURING, INC.	142
M		
M	COOPER POWER SYSTEMS INC	63
M	DEMAT	71
	GFD LETAGE	98
M	HMS SERVICES LLC	111
	KELOX/MICRODOT PRODUCTS, ALCOA FASTENING SYSTEMS & RINGS, ARCONIC FASTENING SYSTEMS & RINGS	127, 15, 23
	LISI AEROSPACE, MONADNOCK COMPANY, THE	140, 159
M	MACKO INDUSTRIES	145
	MAGNUS TOOL & DIE CO., INC.	146
	MEACO PRODUCTS CORP.	151
	MECAERO PRODUCTS, ALCOA FASTENING SYSTEMS & RINGS, ARCONIC FASTENING SYSTEMS & RINGS	152, 15, 23
	MERCURY AEROSPACE INC.	153
M	METALCRAFTERS	153
	METRIX MFG. CO.	154













MIL-HDBK-57J (GS7)
INDEX B

SYMBOL	COMPANY NAME	PAGE
	MI. ME. AF. S.r.1	154
	KAYNAR PRODUCTS, MICRODOT INC, ALCOA FASTENING SYSTEMS & RINGS, ARCONIC FASTENING SYSTEMS & RINGS	127, 155, 15, 23
	MIDWEST ACORN NUT CO.	155
	MILITARY PRODUCTS GROUP, INC.	156
	MILLIPART, INC.	156
M	MINEBEA CO. LTD	157
M	M-MANUFACTURING	158
	MNP CORPORATION	159
	MORTON MANUFACTURING	160
M	MRL MANUFACTURING CORP.	161
M	TWIST TITE MFG. INC.	230
	MACOR, INC.	146
	MIX TOOL CO.	157
	MODERN METRIC MACHINE COMPANY INC.	159
	INFASCO, INFASCO NUT and INGERSOLL FASTENERS	118
MA	M.A.A. CORP.	123
	MAC FASTENERS, INC.	124
	MCCULLOUGH AERO CO.	130
	ADAMS, EARL M. CO.	6
	MAILLY MFG CO., INC.	126
MAX	MID-STATES SCREW CORP.	134
MB	MASTER BOLT & MFG. INC.	149
MB	MASTERBILT, INC	150
MC	ADI MANUFACTURING, INC	6
Mc	MCADAMS MACHINE AND TOOL CO.	129
ME	MECAERO CANADA INC.	131
ME	MECAIR AEROSPACE INDUSTRIES	131
MC	METALCRAFTERS	132











SYMBOL	COMPANY NAME	PAGE
	MID CONTINENT SCREW PRODUCTS CO.	134
	WROUGHT WASHER MANUFACTURING INC.	214
	MILITARY & COMMERCIAL FASTENERS CORP.	156
	MARTIN-CHANDLER, INC.	127
MCO	MEACO PRODUCTS CORP.	130
	McMELLON BROS INC.	130
MD	LEONARD JED CO MARYLAND BOLT AND NUT CO DIV	116-117 128
MD	MARYLAND BOLT & NUT CO., INC.	116-117 128
	MARVIN ENGINEERING, CO., INC.	127
..MEL-BA..	MEL-BA MANUFACTURING INC.	131
METRI	METRIX MFG. CO.	133
METRIX	METRIX MFG. CO.	133
MF	MACLEAN-FOGG CO.	125
MF	MPIRE FASTENERS	139
MFI	MORTON FASTENERS INC.	139
MFR06320	PYE & HOGAN MACHINE CO.	160
MFR 1L071	MIROFINE COMPANY	135
MFR 27624	PB FASTENERS	153
MFR 29839	ADVANCE PATTERN CORP	6
MFR 3L665	C. E. MACHINE CO., INC.	39
MFR - 72905	ARJAY PRECISION, INC.	20
MFR 8F781	STEVENS MFG. CO., INC.	188
	MANUFACTURING ENGINEERING TECH.	126
	MOSTAR GEAR & MACHINE MFG., CO.	139
MI	MECHANICAL & INDUSTRIAL FASTENERS	131
M I	MECHANICAL INDUSTRIES LLC	131
	KELOX/MICRODOT PRODUCTS MICRODOT INC, ALCOA FASTENING SYSTEMS & RINGS, ARCONIC FASTENING SYSTEMS & RINGS	127, 155, 15, 23
	MICRODOT INC, ALCOA FASTENING SYSTEMS & RINGS, ARCONIC FASTENING SYSTEMS & RINGS	155, 15, 23
MIF MIF	MECHANICAL & INDUSTRIAL FASTENERS	152
	MODFORM-ILLINOIS, INC.	159

















MIL-HDBK-57J (GS7)
INDEX B

SYMBOL	COMPANY NAME	PAGE
MI	MONOGRAM AEROSPACE FASTENERS	160
MI-TECH, INC.	MI-TECH, INC.	157
	MIX TOOL CO.	157
MK	LISI AEROSPACE MONADNOCK COMPANY, THE	140, 159
	MKM MACHINE TOOL COMPANY INC.	158
ML	LINREAD NORTHBRIDGE AIRCRAFT PRODUCTS DIVISION ALCOA FASTENING SYSTEMS & RINGS, ARCONIC FASTENING SYSTEMS & RINGS	138, 15, 23
ML	MCLANE MFG INC.	151
MLI	MACHINING LOGISTICS, INC.	144
	M.L.W. MANUFACTURING CO.	144
	MAR-BRO MFG., INC.	147
	MILE-HI MACHINE, INC.	155
	MACKSON MFG CORP.	145
MMG	MMG ENGINEERED COMPONENTS INC	158
M M M	HMS SERVICES LLC	111
	MODERN METRIC MACHINE COMPANY INC	159
	KERR, CHARLES W. and MAUI MEGA	127, 150
	MONROE MACHINED PRODUCTS, INC.	160
MMS	METHODS AND MACHINING SERVICES CO.	153
MMT	MAIN MACHINE CO INC.	147
MNP	MNP CORPORATION	159
	LISI AEROSPACE, MONADNOCK COMPANY, THE	140, 159
MONOGRAM	MONOGRAM AEROSPACE FASTENERS	160
	MAPECO PRODUCTS, INC.	147
MP	MERCER PRODUCTS & MFG. CO., INC.	153
MP	MONTEREY MACHINE PRODUCTS	160
	UMPCO CORP.	231
MR	MACHINERITE CORP.	144

















SYMBOL	COMPANY NAME	PAGE
	MASTER RESEARCH & MFG., INC.	150
MSA	M.S. AEROSPACE	144
MSF	MIL-SPEC FASTENERS CORP.	156
	MANUFACTURING SALES AND SERVICE	147
MT	ALEXANDER MANUFACTURING COMPANY INC	15
MT	AVIBANK MFG., INC.	32
MT	METAL-TECH MFG. INC.	153
MT	METRO TOOL & MANUFACTURING CO.	15, 154
	MASTERCRAFT TOOL COMPANY	150
	MERCURY TOOL & MACHINE, INC.	153
	MANUFACTURING TECHNOLOGY SERVICES	147
MULTI-C	CARDINAL INDUSTRIAL PRODUCTS	54
	MEXEM WORKS	154
	MOTOR WHEEL CORP.	161
MW ORD		
N		
	BIRANT MAKINA LTD STI	40
N	HANSAN SCREW CO., LTD.	105
N	METALCRAFTERS	153
N	MITSUBOSHI INDUSTRIES, LTD.	157
N	MONOGRAM AEROSPACE FASTENERS	160
N	N.S.S. INDUSTRIES	161
N	NAFCO USA, LLC	161
	NAPIER'S AUTO BODY	162
N	NELSON STUD WELDING DIVISION	164
N	NEUMAYER, ERICH GMBH	164
N	NISSAN SCREW CO. LTD.	166
	NOCHIA STEELWORKS	166
	NOVA MACHINE PRODUCTS CORPORATION	168
	NSK INDUSTRIES, INC.	168















MIL-HDBK-57J (GS7)
INDEX B

SYMBOL	COMPANY NAME	PAGE
	NUCOR CORP.	168
N	NUTS INCORPORATED	168
N	NUTS, INC.	168
	ONO MANUFACTURER, INC.	171
NA	NELSON AEROSPACE INC.	164
N_AC	NC AUTOMATED INDUSTRIES INC.	163
NB	LINREAD NORTHBRIDGE ALCOA FASTENING SYSTEMS & RINGS ARCONIC FASTENING SYSTEMS & RINGS	138, 15, 23
	NATIONAL BOLTS & RIVETS LTD.	163
	ND INDUSTRIES	164
	NEVILLE MACHINE SHOP	165
NE	NEKG HOLDINGS	164
NEDIN	NEDSCHROEF	164
NEDLOY	NEDSCHROEF	164
NEDUR	NEDSCHROEF	164
NEI	NORTHEAST METAL CO., INC.	167
	NORTH EAST FASTENERS	167
NF	NEVADA BOLT AND MFG CO INC.	165
NF	NON-FERROUS BOLT & MANUFACTURING CO.	166
NFB	GREER STOP NUT	84, 101
NH	NEDSCHROEF	164
NH	NEW HORIZON MACHINE CO., INC.	165
N_I	NAVPAR, INC.	163
NK	MITSUBOSHI INDUSTRIES, LTD.	157
NK NK	NYLOK CORP.	169
NKYM	MITSUBOSHI INDUSTRIES, LTD.	157
	METALCRAFTERS	153
NMB	MINEBEA CO. LTD	157
	NIPPON MACHINE ENGINEERING, INC.	165
NMP	NUMERIC MACHINE PRODUCTS	168
NRS	NAGOYA SCREW MANUFACTURING CO, LTD.	162
	NARRAGANSETT SCREW MFG., CO.	162
	NISCO, INC.	166
NS	NORTHERN SCREW CO. , INC.	167

SYMBOL	COMPANY NAME	PAGE
	NASU DENKI-TEKKO CO., LTD.	141
NT	NATIONAL THREADED FASTENERS CORP.	163
NT	NT ENGINEERING, INC.	168
NTF99	NORTHBRIDGE FASTENERS	167
NTW	NASSAN TOOL WORKS, INC.	162
	NUCOR CORP.	168
NYLOK	NYLOK CORP.	169
	O	
	KERR, CHARLES W. and MAUI MEGA	127, 150
	MARUYKO NUT CO., LTD.	148
	NATIONAL FASTENER CO., LTD.	163
	OBARS MACHINE & TOOL CO.	169
	OCM MACHINE COMPANY, INC.	169
	OHIO NUT & BOLT CO., THE	169
	ORANGE PRECISION PARTS	171
	SCREWCORP. ALCOA FASTENING SYSTEMS & RINGS ARCONIC FASTENING SYSTEMS & RINGS	204, 15, 23
	VOI-SHAN PRODUCTS ALCOA FASTENING SYSTEMS & RINGS ARCONIC FASTENING SYSTEMS & RINGS	240, 15, 23
	PAOLO ASTORI SPA	174
OAV	A. AGRATI S.P.A.	2
OB	OTT BROTHERS MACHINE CO., INC.	172
OBMC	OTT BROTHERS MACHINE CO., INC.	172
OK	OKAI IRON WORKS, INC	170
	OSTEEN MACHINE SHOP	172
	LOOS & CO., INC.	143
OP	ORANGE PRECISION PARTS	171
OPC	OTTAWA PRODUCTS CO., INC.	172
ORPE	ORDNANCE PARTS & ENGINEERING CO.	172
	ORC PRODUCTS INC.	171
ORC-O	ORC-O TOOL & MACHINE, INC.	171
	OHKAWA SCREW MFG. CO., LTD. and OKAWA SCREW MANUFACTURING CO., LTD	170

MIL-HDBK-57J (GS7)
INDEX B

SYMBOL	COMPANY NAME	PAGE
(OTC)	ORLOTRONICS CORP	172
OTF	OAKTREE FASTENERS CO.	169
	P	
P	BELL FASTENERS	38
P $\frac{4}{B}$	BLANC AERO INDUSTRIES and LISI	41, 140
P	H. PAULIN & CO. LTD.	103
	H. PRINZ GmbH	104
	LELAND-POWELL FASTENERS, INC.	134
P	LISI AEROSPACE	140
	LISI AEROSPACE	140
	LISI AEROSPACE	140
	OMEGA THREAD ROLLING AND GRINDING INC.	170
	PLAINVILLE MANUFACTURING CO., INC.	181
P	ORANGE PRECISION PARTS	171
	P.C.M., INC.	173
	PARKER FASTENERS, LLC	175
P	PATEREX, LTD.	175
P	PAULIN, H. & CO., LTD.	175
	PEINER UMFORMTECHNIK GmbH	177
	PENN CIGAR MACHINES INC (P.C.M INC)	177
	PERIGEE MANUFACTURING COMPANY, INC.	179
	PERKINS MACHINE CO.	179
	PIONEER SCREW & NUT CO.	180
	POLYTECHNIC INDUSTRIES	181
	PRECISION PIECE PARTS, INC.	183
P	PRESTIGE STAMPING, INC.	184
	PROTO MACHINE CO., INC.	186
	PTM INTERNATIONAL INC	186
P	PURITAS METAL PRODUCTS	186
PABCOR	PABCOR, INC.	173

SYMBOL	COMPANY NAME	PAGE
PAL	PALNUT CO. , THE	174
PAL	TRW	229
PAM	ABBOTT, PETER	3
PAM	PRECISION AIRCRAFT MACHINING CO., INC. DBA PAMCO	183
PAMCO	PRECISION AIRCRAFT MACHINING CO., INC. DBA PAMCO	183
	PRECISE AERO PRODUCTS	182
	PATRIOT MANUFACTURING	175
PB	PB FASTENERS	176
PB	PORTLAND BOLT & MFG., CO.	181
	UPB ENGINEERING	234
PBB	LISI AEROSPACE	140
 PBF	PB FASTENERS	176
PC	APHEONIX CORPORATION	22
	PRODUCT DEVELOPMENT GROUP, INC.	185
PE	PENNEENGINEERING AUTOMOTIVE FASTENERS	179
PE	PENN ENGINEERING & MANUFACTURING CORP.	177
Pear	PEAR, INC.	176
	PROMPTUS ELECTRONIC HARDWARE	185
PEINER	PEINER UMFORMTECHNIK GmbH	177
	PENN ENGINEERING & MANUFACTURING CORP.	177
 	PENN ENGINEERING & MANUFACTURING CORP.	177
PF	PRECISION FITTINGS, INC.	182
PHP	PNEU-HYDRO PRODUCTS, INC.	181
	P & I ASSOCIATES, INC.	173
	POSIMECH, INC.	182
PIP	AVIBANK MFG., INC.	32
 	KAPCO INDUSTRIES, INC.	126
	P & L ENTERPRISES	173
PM	H. PAULIN & CO. LTD.	103
PM	PAULIN, H. & CO., LTD.	175
	PRICE MANUFACTURING CO.	184

MIL-HDBK-57J (GS7)
INDEX B

SYMBOL	COMPANY NAME	PAGE
PMC	BELL FASTENERS	38
	POINT MACHINE COMPANY	181
	PRECISIONMATICS CO., INC.	184
	PRIETO MACHINE COMPANY, INC.	185
PMC	VERTEX DISTRIBUTION	237
PMI	PADGETT MACHINE INC.	174
pmi	PEREZ MACHINE, INC.	179
PMI	PROFORMANCE MANUFACTURING, INC.	185
PMP	PIONEER MACHINE PRODUCTS, INC.	180
PMP	PURITAS METAL PRODUCTS	186
	PRO-MACHINE & TOOL COMPANY	185
	PATTERSON LAKE PRODUCTS	175
-PPC-	PARK PRECISION CORPORATION	174
	POWERPARTS, INC.	182
PR	PINEY RIDGE CO.	180
PRD	PRD FASTENERS LTD.	182
	PRECI-MANUFACTURING, INC.	182
	H. PRINZ GmbH	104
	P.S. MACHINE CO., INC.	173
P S	PACIFIC SCIENTIFIC	174
	PEERLESS SCREW PRODUCTS	176
	PHOENIX SPECIALTY MANUFACTURING CO., INC.	179
PSB	PRECISION SCREW & BOLT, INC.	183
PSM PSM	PENN SCREW & MACHINE WORKS, INC.	179
	PRODUCTION & TOOL COMPANY	185
	PACIFIC TOOL, INC.	174
PTI	PAINTER TOOL, INC.	174





















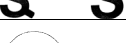



SYMBOL	COMPANY NAME	PAGE
	PRECISION TECHNOLOGIES, INC.	184
PTM	PINE TAVERN MACHINE INC.	180
PTP	PRECISION THREADED PRODUCTS, INC.	184
PTX	PATEREX, LTD.	175
	TRW	229
PV	PV ENGINEERING & MFG., INC.	186
Q		
	QSN MANUFACTURING, INC.	186
Q	QUALITY SCREW PRODUCTS, INC.	187
QAS	QUALITY AIRCRAFT SCREWS, INC.	186
QB	QUALITY BOLT & SCREW CO.	187
	CELTECH ENTERPRISE	56
	QUALITY FABRICATIONS, INC.	187
	QUALITY MACHINE & MFG INC.	187
QMS	QUALITY MACHINE SERVICES LLC	187
	QUALITY SOCKET SCREW MANUFACTURING CORP.	187
QT	QUALITY THREADED PRODUCTS COMPANY	187
R		
R	R.E.C. CORP.	190
	RAHMEDE SCHRAUBENFABRIK	190
R	RAM THREADING, INC.	191
R	RAMAR NUTS, INC.	191
r	RELLI TECHNOLOGY, INC.	193
R	REPUBLIC FASTENER MANUFACTURING CORP., ALCOA FASTENING SYSTEMS & RINGS, ARCONIC FASTENING SYSTEMS & RINGS	193, 15, 23
	RINCO TECHNOLOGIES, INC.	195
	ROBBINS MANUFACTURING	196
	ROCKFORD BOLT & STEEL CO.	197





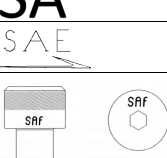



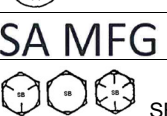

















MIL-HDBK-57J (GS7)
INDEX B

SYMBOL	COMPANY NAME	PAGE
	ROCKFORD FASTENERS INC.	197
	ROCKFORD PRODUCTS CORP.	197
	ROGG MANUFACTURING COMPANY	198
R	RONSON MANUFACTURING, INC.	198
	RUMCO, INC.	199
•R	UNIFLOW CORP.	231
R9	REID PRODUCT INC.	193
RAE	RAE MANUFACTURING CO.	190
RAM	RAM PRODUCTS ALCOA FASTENING SYSTEMS & RINGS, ARCONIC FASTENING SYSTEMS & RINGS	191, 15, 23
	R. BILD COMPANY, INC	189
	ROCKFORD BOLT & STEEL CO.	197
	R B & W CORPORATION	189, 192
	DOUBLECO INCORPORATED DBA R & D FASTENERS	74, 188
	R & D WELDING & MACHINE INC.	188
	RAMM DEFENSE PRODUCTS	192
RE	RAM ENTERPRISES	191
	REED INSTRUMENT CO.	193
REP	RIVNUT ENGINEERED PRODUCTS, INC.	196
	REXNORD INC., ALCOA FASTENING SYSTEMS & RINGS, ARCONIC FASTENING SYSTEMS & RINGS	194, 15, 23
	ROBERT HENRY CO., INC.	197
RI	REXNORD INC. ROSAN PRODUCTS, ALCOA FASTENING SYSTEMS & RINGS, ARCONIC FASTENING SYSTEMS & RINGS	194, 15, 23
RI	RUDOLPH INSTRUMENTS, INC.	199
RIBE	BERGNER, RICHARD GMBH & CO.	39
R.I.E.	R & I ENTERPRISES DBA COMPULOGIC DESIGN CO.	188
RIPA	RIPA ENGINEERING CORP	196















SYMBOL	COMPANY NAME	PAGE
	R B & W CORPORATION	189, 192
R/M	RICHARD MANNO & CO., INC.	194
	RICHARD MFG. CO., INC.	194
	RAINBOW MACHINE PRODUCTS, INC.	191
RMS	RMS	196
RNO RNO	ONDRIVES. US CORP	170
ROL	ROLAND AEROSPACE	198
RP	RUDOLPH PRECISION PRODUCTS	199
Rp	REID PRODUCT INC.	193
	R & R PRECISION	188
RR	GRUPO RASSINI S.A. de C.V.	102
RS	RS MANUFACTURING, INC.	198
RT	AVIBANK MFG., INC.	32
	RUSCOMB TOOL & MACHNE CO., INC.	199
RV	RAGHU VAMSI MACHINE TOOLS PVT LTD	190
RVT	RIVER VALLEY TOOL & MANUFACTURING	196
	RA-WHITE, INC.	192
	RADAX INDUSTRIES, INC.	190
S		
S	BELL FASTENERS	38
	STELFAST, INC., CHIANG SHIN FASTENERS INDUSTRIES, LTD	217 59
	CHIANG SHIN FASTENERS INDUSTRIES, LTD	59, 217
S	J.P. PRODUCTS, INC.	122
	MNP CORPORATION	159
	NIPPON STEEL BOLTEN CO., LTD.	166
	S.I. STUD, INC.	200
S	SABRE MANUFACTURING, INC.	201
	SAI INDUSTRIES CORP., SRI SAI INDUSTRIES CORPORATION	202, 214
S	SCHUHL & CO. GMBH	203
•S•	SALES SYSTEM, LIMITED	202
	SEMBLEX CORP.	204

















MIL-HDBK-57J (GS7)
INDEX B

SYMBOL	COMPANY NAME	PAGE
	RING SCREW WORKS, SEMCO FASTENER	195, 204
	SENG HENG ENGINEERING PTE LTD.	205
	SONIC INDUSTRIES, INC.	209
	SESCO INDUSTRIES, INC.	205
	SHACKELFORD MACHINIG, INC.	205
	SHEFFIELD, INC.	206
	SHIGA BOLT CO., LTD.	206
	SIERRACIN/HARRISON	207
	SKYLINE INDUSTRIES	208
	SPECIALS, INC.	211
	SPECIALTY SCREW CORP.	211
	SPS TECHNOLOGIES	213
	SRI SAI INDUSTRIES CORPORATION	202, 214
	STANDARD NUT & BOLT, INC.	215
	STELFAST FASTENERS, INC.	217
	STERLING MFG. & SUPPLY, INC.	218
	SULLIVAN BOLT CO., INC.	220
	U.S. BOLT MANUFACTURING, INC.	231
	WILHELM SCHUMACHER SCHRAUBEN-FABRIK GmbH	245
	BULTEN TRADING AB	47
	SPENCER AEROSPACE MANUFACTURING, LLC	211
	SPACE AGE ENGINEERING, INC.	210
	SAFETY SOCKET LLC.	201
	SANTA ANA GEAR & MACHINE	202
	D'SAMIC	74
	SOUTHWEST ALLIED PRODUCTS CO., INC.	210
	SPEARMAN AEROSPACE	211
	SOUTH BAY BOLT MANUFACTURING CO.	209

SYMBOL	COMPANY NAME	PAGE
	S. B. E. (ITALY CORPORATION)	200
	SPS TECHNOLOGIES	213
	SHOPCO MANUFACTURING, INC.	206
	STELFAST FASTENERS INC.	217
	STERLING MACHINE COMPANY	218
	VOI-SHAN PRODUCTS ALCOA FASTENING SYSTEMS & RINGS ARCONIC FASTENING SYSTEMS & RINGS	240, 15, 23
	SCANDIA MFG. CO., INC.	203
	STEEL CITY BOLT & SCREW, INC.	216
	SCOTT CRAFT CO.	204
	SPURWAY COOKE INDUSTRIES PTE LTD.	214
	CAMCAR DIVISION OF TEXTRON INC.	50
	SIMMONDS PRODUCTS, ALCOA FASTENING SYSTEMS & RINGS ARCONIC FASTENING SYSTEMS & RINGS	207, 15, 23
	STALKER & DYSTHE, INC.	215
	TANAKA LTD.	
	CAMCAR DIVISION OF TEXTRON INC.	40-43
	SOUTHERN FASTENER CORPORATION	181
	SUNLAND AEROSPACE FASTENERS	220
	SONFARREL, INC.	180
	SHAMROCK FASTENER TECHNOLOGIES, LLC	177
	SAGA TEKKOSHO CO., LTD.	174
	STAR-GLO INDUSTRIES LLC	215
	SHUR-LOK CORP.	178
	SIERRA PACIFIC SUPPLY CO., INC.	179
	SOUTHWEST INDUSTRIAL SERVICES	210
	PMB PRECISION PRODUCTS INC.	181
	SPRING INTERNATIONAL	212

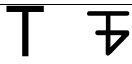
MIL-HDBK-57J (GS7)
INDEX B

SYMBOL	COMPANY NAME	PAGE
S II	SUBURBAN INDUSTRIES, INC.	219
	SHUR-KUT SUPPLY CORPORATION	206
SL	S & L FASTENERS, LLC	200
S & L	S & L METAL PRODUCTS CORP.	200
SL	S & L TOOL	200
	SHUR-LOK COMPANY.	207
SL	ST. LOUIS SCREW & BOLT CO.	214
	GREER STOP NUT	84, 101
SLI	SPACE-LOK, INC.	210
	STANDARD LOCKNUT, INC.	215
	SAMUEL MARSDEN & SON	202
SM	MACLEAN SKY	145
	STURM MACHINE CO., INC.	219
SMF	SATAIR MANUFACTURING FACILITY	203
	SANDIK MANUFACTURING, INC.	202
SMP	SHORELINE MACHINE PRODUCTS, INC.	206
SM&M	SMITH MACHINE & MANUFACTURING	208
	SLABE MACHINE PRODUCTS	208
SMS	SALEM MANUFACTURING AND SALES, INC.	202
	STACY MACHINE & TOOLING, INC.	214
southco	SOUTHCO, INC.	209
	FILETAGE INTERNATIONAL	91
	SKYSPARES PARTS, INC.	208
	SPC THREADED	211
SPCK	SPRING CREEK MANUFACTURING, INC.	212
SPG	SHAW PRECISION GRINDING, ACE GRINDING & MFG. CO. OF TEXAS	205, 5
	SMALL PARTS MANUFACTURING CO., INC.	208
	SPARTAN PRECISION MACHINE	210
	STEEL PRODUCTS OF MASSILLION	216

SYMBOL	COMPANY NAME	PAGE
SPS SPS	SPS TECHNOLOGIES	213
	SPACE SCREW, INC.	210
	SUGAR RIVER MACHINE SHOP	219
	MNP CORPORATION	159
	SOUTHERN FASTENING SYSTEMS	209
ST	AVIBANK MFG., INC.	32
	SWISS TECHNOLOGY, INC.	220
	SPIRAL TOOL CORP.	212
	STEADFAST CORPORATION	215
	SINN-TECH, INC.	207
	HALL INDUSTRIES INC., STANDARD TOOL & MACHINE CO.	104, 215
STM	SPECIAL-T-METALS	211
STRUX (radial)	CAMCAR DIVISION OF TEXTRON INC.	50
SV	S V INDUSTRIES	220
SW	BELL FASTENERS	38
	SMITH WELDING, INC.	208
SW	STILLWATER FASTENERS, INC.	219
	SOUTHWIND INDUSTRIES, INC.	210
	SHEREX FASTENING SOLUTIONS, LLC	206
T		
	ARCHER SCREW PRODUCTS	22
T	BLANC AERO INDUSTRIES	41
T	ENGLE MANUFACTURING COMPANY, INC., THE	83
	LISI AEROSPACE	140
T	MINEBEA CO. LTD	157
	OSAKA SEIKI CO., LTD.	172
	RING SCREW WORKS	195
T	SPS TECHNOLOGIES	213
	T & E MACHINE CORP.	221
	TORCO, INC.	227

MIL-HDBK-57J (GS7)
INDEX B

SYMBOL	COMPANY NAME	PAGE
	TAKENAKA SEISAKUSHO CO., LTD.	221
I	TECHNICAL FASTENERS, INC.	222
T	TELEFAST INDUSTRIES, INC.	222
T	TERRY MACHINE CO.	223
	TEXAS BOLT CO.	223
	TEXTRON FASTENING SYSTEMS	224
	TITAN FASTENER	195, 226
	TOPURA CO., LTD.	226
	TOWNSEND CO.	227
	TOYO STEEL WIRE CO., LTD.	227
	TRY - AZTEC COMPANY	229
TANSEY	ARVAN, INC.	28
	TEBCO THREADED FASTENERS	222
	TEXAS BOLT CO.	223
	T-B & S MFG.	222
TBJ	SPS TECHNOLOGIES	213
TC	TERRYCABLE, INC.	223
TCQ	T C QUALITY MACHINING INC.	221
	T & E MACHINE CORP.	221
	TEK PRECISION CO., LTD.	222
TELLEP	SPS TECHNOLOGIES-METALAC SPS INDUSTRIA	213
TENS	TENS MACHINE CO., INC.	223
	TEXAS BOLT CO.	223
TEXAS BOLT		
F	HI-SHEAR CORP. and TORONTO FASTENERS INDUSTRIES, INC.	110, 227
TF	TELEFAST INDUSTRIES, INC.	222
	TFI AEROSPACE CORPORATION	224
	TFP CORP.	224















SYMBOL	COMPANY NAME	PAGE
F	TUFF FASTENERS CO.	230
F	TFI AEROSPACE CORPORATION	224
	TFI AEROSPACE CORPORATION	224
TFI	TFI AEROSPACE CORPORATION	224
	TFP CORP.	224
TF USA	TELEFAST INDUSTRIES, INC.	222
THE	TONG HWEI ENTERPRISE CO., LTD.	226
	THIANT (BOULONNERIE DE SA)	225
THOMAS	THOMAS MFG, INC.	226
	THOMAS INSTRUMENT & MACHINE CO., INC.	225
	LEBRECHT TIGGES GmbH & CO. KG, SCHMICO GMBH SCHWEISSTECHNIK	134, 203
TJB	SPS TECHNOLOGIES	213
TKS	TOKOSHA METAL WORKS LTD.	226
	TOOLEX, INC.	226
TLP	SPS TECHNOLOGIES	213
	SPS TECHNOLOGIES	213
	TERRY MACHINE CO.	223
	TRIDENT MACHINE CO.	228
TM	TRONSON MANUFACTURING	228
TM9	SPS TECHNOLOGIES	213
TMC	LISI AEROSPACE, MONADNOCK COMPANY, THE	140, 159
	FARLO MACHINE & TOOL CO., INC.	87
TMS	MACHINE SHOP, INC., THE	144
TMTI	THOMAS MACHINING TECHNOLOGIES, INC.	225
TN	NICE TOOL MFG., INC.	165
	TOG MANUFACTURING CO., INC.	226
	OTO MELARA S.p.A.	172
TORX (radial)	CAMCAR DIVISION OF TEXTRON INC.	50
TOPURA	TOPURA CO., LTD.	226
TP	TOPURA CO., LTD.	226



















MIL-HDBK-57J (GS7)
INDEX B

SYMBOL	COMPANY NAME	PAGE
	TEXAS PRECISION MFG., INC.	223
TR	T R MACHINE INC.	221
	TOWNE ROBINSON FASTENER CO.	227
TRI	TRIUMPH MANUFACTURING CO., INC.	228
Tridair 	REXNORD INC., ALCOA FASTENING SYSTEMS & RINGS, ARCONIC FASTENING SYSTEMS & RINGS	194, 15, 23
TRIDAIR	TRIDAIR PRODUCTS, REXNORD INC., ALCOA FASTENING SYSTEMS & RINGS, ARCONIC FASTENING SYSTEMS & RINGS	228, 194, 15, 23
	TRW	229
TST	TS TEKNADYNE	229
TT	TWIST TITE MFG., INC.	230
TTC	CAMCAR DIVISION OF TEXTRON INC.	50
TUZ	MAUDLE INDUSTRIAL CO., LTD.	150
	SUNDRAM FASTENERS, LTD.	220
	TFP CORP.	224
	TW DESIGN AND MANUFACTURING, L.L.C.	230
	LENCH, THOMAS WILLIAM, LTD.	135
TYE	YOUNG ENGINEERS INC, THE	249
U		
	OHKAWA SCREW MFG. CO., LTD. and OKAWA SCREW MANUFACTURING CO., LTD	170
	OKABE CO., INC.	170
	R B & W CORPORATION	189, 192
U	SPS TECHNOLOGIES	213
U	UNIMETERIC CORPORATION	232
	UNITED DRILL BUSHING CORP.	232
	URANIA ENGINEERING CO., INC.	234
	URBAN MANUFACTURING CO.	234















SYMBOL	COMPANY NAME	PAGE
	URBAN MFG. CO. INC.	234
U130	SPS TECHNOLOGIES	213
UA	UPSTART ACQUISITIONS CORP., DBA BET-LAR SERVICES	234
	UDT, INC.	230
UEH	UNICORP	232
UH	CHU HUA INDUSTRIAL CO., LTD.	60
UM	SPS TECHNOLOGIES	213
UM	UNIVERSAL MACHINE PRODUCTS	233
	ULTIMATE MACHINING & WELDING	231
UNBRAKO	SPS TECHNOLOGIES	213
	SPS TECHNOLOGIES	213
	UNISTRUT CORP.	232
UNW	SPS TECHNOLOGIES	213
UP	UNITED PRECISION PRODUCTS CO., INC.	232
UPME	U.P. MACHINE & ENGINEERING CO.	230
	UNITED STATES DEFENSE RESEARCH & SUPPLY	233
	UNITED STEEL & FASTENERS INC.	233
	UNIVERSAL PRECISION SCREWS	233
	DOMESTIC FASTENER & FORGE, INC	73
	U.S.A. SPARES INC.	231
USMC	ULTRA SONIC MACHINE CO., INC	231
USP	UNLIMITED SCREW PRODUCTS, INC.	233
USP	USP AEROSPACE SOLUTIONS, INC.	235
	US TOOL & DIE	234
UT	UNITED TITANIUM, INC.	233
V		
V	AERCO RESEARCH	8
	AERO COMPONENTS CO	9









MIL-HDBK-57J (GS7)
INDEX B

SYMBOL	COMPANY NAME	PAGE
V	CHAMPION COMMERCIAL INDUSTRIES, INC.	58
V	MNP CORPORATION	159
	V-B MACHINE CO., INC.	236
	VANTAGE POINT MANUFACTURING	236
V	VICO PRODUCTS, CO.	237
V 	VICTOR PRODUCTS CORP.	237
	VISTA MACHINING COMPANY	238
	VISTEK INDUSTRIES	238
	VITCO NUCLEAR PRODUCTS INC.	238
.V.	VMC INDUSTRIES, INC.	239
V	VOSS INDUSTRIES, INC.	241
V. V. ³⁰⁴ V.	VULCAN RIVET & BOLT CORP.	241
VALCOR	VALCOR ENGINEERING CORP.	235
VERBUS	BAUER & SCHAURTE KARCHER GMBH	35
VF 	MNP CORPORATION	159
	VALLEY FORGE AND BOLT MFG CO.	235
	VENUS FASTENERS CORP.	236
V F M	VEGAS FASTENER MANUFACTURING VIP MFG. & ENGR. CORP.	236 237
		
	VM MANUFACTURING CORP.	238
VMC	VMC INDUSTRIES, INC.	239
VMC	VORTEX MFG CO.	241
	VOSS INDUSTRIES, INC.	241
VP	VAN PETTY MFG., INC., ALCOA FASTENING SYSTEMS & RINGS ARCONIC FASTENING SYSTEMS & RINGS	235, 15, 23
VS VS VS	VOI-SHAN PRODUCTS, ALCOA FASTENING SYSTEMS & RINGS ARCONIC FASTENING SYSTEMS & RINGS	240, 15, 23
VS	VSI	241
	VERSATECH, INC.	236
 VT	VALLEY-TODECO, ALCOA FASTENING SYSTEMS & RINGS	235, 15, 23





SYMBOL	COMPANY NAME	PAGE
	ARCONIC FASTENING SYSTEMS & RINGS	
W		
W	MEC WOLF SRL	151
	WALZ & KRENZER INC DBA MAPECO PRODUCTS	242
	WARREN PUMPS LLC	242
	WATERBURY BUCKLE CO.	242
	WAYNE BOLT & NUT CO., INC.	242
W	WELTON ROLLED THREAD CORP.	243
W	WESTLAND STEEL PRODUCTS, LTD.	244
	WHELAN MACHINE & TOOL CO.	245
	WHITNEY SCREW CORP.	245
	WIGLEY MACHINE COMPANY	245
	WILLIAM'S MACHINE & FABRICATION, INC.	245
W	WINKER HERMAN GMBH & CO. KG	246
	WITTEN COMPANY, INC.	247
	WODIN, INC.	247
	WOLTERS GMBH	247
	WROUGHT WASHER MANUFACTURING INC.	248
	WYANDOTTE INDUSTRIES, INC.	248
	WYNNSON ENTERPRISES, INC.	248
	WINSLOW AUTOMATICS, INC.	246
WB	WALKER BOLT MANUFACTURING CO., INC.	241
	WEBLUK MACHINE CORP.	242
 WC	WEST COAST AEROSPACE, INC.	243
WEDGELOCK	MONOGRAM AEROSPACE FASTENERS	160
WESLOK	WESLOK	243
	WESTFIELD FASTENERS	244
	WILSON-GARNER CO.	246











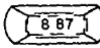



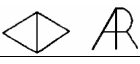





MIL-HDBK-57J (GS7)
INDEX B

SYMBOL	COMPANY NAME	PAGE
	RATHMANN WALTER G. SEGMENT-KLAMMERSCHRAUBEN GMBH	192
	WHITTET-HIGGINS CO.	245
WH	WOLTERS GMBH	247
	WINEGAR, INC	246
	WOLSTENHOLME MACHINE	247
WMI	WEAVER MANUFACTURING, INC.	242
	WIL-NIC	246
	WESTERN PACIFIC ENTERPRISES, W.P.E. INC.	243
	WESTWOOD PRECISION, INC.	244
	WILT PRECISION PRODUCTS	246
WSE	WEST SHORE ENGINEERING, INC.	243
	CUTTING EDGE MACHINING INC., WESTERN SCREW MACHINE PRODUCTS, INC.	66, 244
WSI	WESTERN SKY INDUSTRIES, INC.	244
WSMP	WORTHEY MACHINE	248
	KAMPWERK VIEREGGE U. PICKARDT GMBH. & CO.	126
	WILHELM SCHUMACHER SCHRAUBEN-FABRIK GmbH	245
	TW DESIGN AND MANUFACTURING, L.L.C.	230
	WA TAI INDUSTRIAL COMPANY, LTD	241
WT		
WWE	LINREAD NORTHBRIDGE AIRCRAFT PRODUCTS DIVISION, ALCOA FASTENING SYSTEMS & RINGS, ARCONIC FASTENING SYSTEMS & RINGS	138, 15, 23
X		
X	X-TECH INNOVATIONS INCORPORATED	248
XBF	EXTREME BOLT & FASTENER, LLC	86
	EXCEL PRECISION PRODUCTS, INC.	85
XP	R B & W CORPORATION	189, 192
Y		

























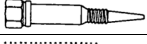

SYMBOL	COMPANY NAME	PAGE
	YOW MENGI INDUSTRIAL CO., LTD.	249
Y 2 K	Y2K MACHINE SHOP	249
	FANG SHENG SCREW CO., LTD.	87
	YATES TOOL, INC.	249
Z		
Z	D.S.O. PLASTICS, INC.	67
Z or Z	FITZ MANUFACTURING INDUSTRIES LTD DBA FMI	92
	ZAMON CO., INC.	250
Z	ZERO PRODUCTS , INC.	250
	Z & B GENERAL MACHINE	249
ZENEX	ZENEX CORPORATION	250
	ZERO PRODUCTS , INC.	250
NUMBER		
	AERO-FAB, INC.	10
0FOY2	ADVANCED MACHINING TECHNOLOGIES	8
0J8	ANATASE PRODUCTS	21
0MXJ8	NORTHSTAR ENGINEERING	167
01DC	RISCO, INCORPORATED	196
	MAC FASTENERS, INC.	144
01FF	SPACE CITY SCREW & MFG., INC.	210
01FO	ACCUTOOL	5
01FO	SUBCON TOOL/ACCUTOOL MACHINE GROUP INC. (DBA ACCUTOOL)	219, 5
01IG	SEMS AND SPECIALS, INC.	204
01NU	EAGLEHEAD MANUFACTURING COMPANY	77
02KS2	SIMFER PRECISION MACHINE	207
05DT8	FITZ MANUFACTURING INDUSTRIES LTD DBA FMI	92
05141	McMELLON BROS INC.	151
09094	QRP, INC.	186
1A249	ACCURATE THREADED PRODUCTS CO.	5
1EM77	GS AEROSPACE TECHNOLOGY, INC.	102
1HEW6	SHOPCO MANUFACTURING, INC.	206
1H423	J & M MACHINE INC.	121
1S5U7	AMERICA AEROSPACE PRECISION MFG	18











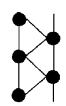

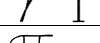











MIL-HDBK-57J (GS7)
INDEX B

SYMBOL	COMPANY NAME	PAGE
1st	FIRST AMERICAN SALES CO.	91
1Y128	D & D MACHINERY AND SALES	66
1YFG0	MAGNUM MACHINE SHOP	146
11934	SEILER INSTRUMENTS AND MANUFACTURING COMPANY, INC.	204
15077	NORTHBRIDGE FASTENERS	167
2	STERLING MACHINE COMPANY	218
2F 3F 4F 5F	FONTANA LUIGI S.p.A.	94
2A832	JMT MACHINE COMPANY	124
20733	NORTHBRIDGE FASTENERS	167
	UTAH TOOL & DIE, INC.	235
28548	FABRICATION SPECIALTY INC.	86
	3D MACHINE COMPANY, INC	1
3D531	ALAN, JEFFREY, MFG. & ENGR	14
	MODERN METRIC MACHINE COMPANY INC.	159
3V 3V	3 V FASTENERS	1
30633	C & H MFG., INC.	48
32219	NORTHBRIDGE FASTENERS	167
33575	J.F. FREDERICKS TOOL CO.	121
4J952	GENERAL AVIATION MFG., INC.	97
4J976	REGAL AIR, INC	193
4N133	CHATHAM PRECISION, INC.	59
4T853	D & R MACHINE COMPANY	67
5N319	INDIANA AIRCRAFT HARDWARE	116
5T572	NORTHBRIDGE FASTENERS	167
509W0	BOMBSHELL, INC.	43
54878	ROTAIR INDUSTRIES, INC.	198
56878	SPS TECHNOLOGIES	213
6F140	COMPONENT PRODUCTS CORPORATION	62
	BISHOP ENTERPRISES, INC.	40
60529	STERLING MFG. & SUPPLY, INC.	218
61062	COMET MFG. CO., INC.	62
62206	B & B SPECIALTIES, INC.	33
7	HEPTNER MFG CO.	108
71838	SPS TECHNOLOGIES	213
8F781	STEVENS MFG. CO., INC.	218
8M938	PRODUCTS DESIGN & MFG. CORP.	185
8T968	ROMAC ELECTRONICS, INC.	198
80539	SPS TECHNOLOGIES	213
84256	AVIBANK MFG., INC.	32

























SYMBOL	COMPANY NAME	PAGE
	THIANT (BOULONNERIE DE SA)	225
96458	JAMES IPPOLITO & CO., INC.	122
99106	AMERICAN AIRCRAFT PARTS MANUFACTURING COMPANY	19
9R	REID PRODUCT INC.	193
SYMBOL		
	3 V FASTENERS	1
	A & G ENGINEERING CO., INC	1
	ACCURA INDUSTRIES, INC.	4
	ACME RIVET & MACHINE CORP.	6
	ACRODYNE MFG CO.	6
	ADVANCE MACHINE WORKS, CORP	7
	ADVANCED MANUFACTURING TECHNOLOGIES, INC.	8
	AEROSPACE RIVET MFG CORP	11
	ALCOA FASTENING SYSTEMS & RINGS ARCONIC FASTENING SYSTEMS & RINGS KAYNAR PRODUCTS MICRODOT INC.	15, 23, 127, 155
○	ALCOA GLOBAL FASTENERS INC ALCOA FASTENING SYSTEMS & RINGS ARCONIC FASTENING SYSTEMS & RINGS	15, 15, 23
	ALCOA FASTENING SYSTEMS & RINGS ARCONIC FASTENING SYSTEMS & RINGS	15, 23
	ALL PINS MANUFACTURING	16
=	ALL-STATES INC.	16
	AMERICAN PRIDE FASTENERS, LLC	20
	AMERITECH FASTENER MFG INC.	20
	ANCHOR BOLT & SCREW CO.	21
	ANDROCK HARDWARE CORPORATION	21
	ANILLO INDUSTRIES, INC.	21
	ARCONIC FASTENING SYSTEMS & RINGS	23
	ARGARWAL INDUSTRIES	26
	ARMSTRONG PRECISION COMPONENTS LTD.	27
	ASI DESIGN & MANUFACTURING, INC.	28





























MIL-HDBK-57J (GS7)
INDEX B

SYMBOL	COMPANY NAME	PAGE
	AUTO SCREW, INC.	31
	AVDEL INTERNATIONAL	31
	AVK INDUSTRIES PRODUCTS INC.	32
	AVIBANK MFG., INC.	32
	AZTECH ENGINEERING, INC.	33
	AZTECH LOCKNUT CO.	33
	BAUER & SCHAURTE KARCHER GMBH	35
	BOLLHOFF & CO. GmbH & CO. KG	42
	CARR CO.	54
	CARDINAL MACHINING SERVICES LLC.	54
	CENTENNIAL BOLT, INC.	56
 <small>Circle with center dot</small>	CLEVELAND HARDWARE & FORGING, GREEN BAY DROP FORGE	60, 100
	CODLING TOOL & MFG. INC.	61
	COLD HEADING CO., THE	62
	CUTTING EDGE MACHINING SOLUTIONS, INC	66
	DAVIS AIRCRAFT PRODUCT CO., INC.	68
	DO-ALL PRECISION, INC.	73
	DRESSER INDUSTRIES, INC.	74
	EDS ORDNANCE	78
	ELCO INDUSTRIES, INC.	78
	GEN FAST MANUFACTURING COMPANY	9797
	STELCO FASTENER & FORGING CO.	216
	EMHART CORP.	80
	FRIEDR BOESNER GMBH	95
	FENTON HEADING	91, 195
	FERNDALE FASTENER	91, 195

SYMBOL	COMPANY NAME	PAGE
	FISCHER SPECIAL MFG. CO.	92
	FOREST FASTENERS	94
	GMP CO. CORPORATION	99
	PILGRIM SCREW CORP.	180
	GRADON SCREW MACHINE CORP.	100
	GROOV-PIN CORPORATION	102
	HANDI GADETS CORP.	104
	HEARTLAND PRECISION FASTENERS, INC.	107
	HESSISCHE SCHRAUBENFABRIK WELTER GmbH & CO., KG	108
	WELTER GMBH & CO. KG	242
	HOUSTON FASTENER	112
	HUCK INTERNATIONAL INC.,	114, 15, 23
	ALCOA FASTENING SYSTEMS & RINGS, ARCONIC FASTENING SYSTEMS & RINGS	114, 15, 23
	HUCK INTERNATIONAL INC.,	114, 15, 23
	ALCOA FASTENING SYSTEMS & RINGS, ARCONIC FASTENING SYSTEMS & RINGS	114, 15, 23
	HURRICANE MACHINE COMPANY, L.L.C.	115
	INDUX, S.A. DE C.E.	118
	INFASCO NUT, INGERSOLL FASTENERS	118, 118
	INFASCTECH DECORAH LLC.	118
	ITW CIP	120
	KOBE FASTENER LIMITED	129
	KOREA BOLT IND., CO., LTD.	129
	KPF	130
	LBL PRODUCTS	134
	LIGHTNING BOLT & SUPPLY, INC.	138

MIL-HDBK-57J (GS7)
INDEX B

SYMBOL	COMPANY NAME	PAGE
	LINREAD NORTHBRIDGE AIRCRAFT PRODUCT DIVISION, ALCOA FASTENING SYSTEMS & RINGS, ARCONIC FASTENING SYSTEMS & RINGS	138, 15, 23
	LISI AEROSPACE	140
	LISI AEROSPACE	140
	LISI AEROSPACE	140
	MACK, A. W. MFG CO.	145
	MINEBEA CO. LTD	157
	MILITARY & COMMERCIAL FASTENERS CORP.	156
	MNP CORPORATION	159
	NATIONAL AEROSPACE FASTENERS CORPORATION (NAFCO)	163
	NAGOYA SCREW MANUFACTURING CO, LTD.	162
	NCMI BRUEGGEMANN INC.	164
	ONEIDA TOOL & MACHINE CORP.	171
	PACER ALLOYS, INC.	173
	PAOLO ASTORI SPA	174
	PECO AEROSPACE FASTENERS	176
	PELHAM AUTO MATRIX PRECISION	177
	PINTO PRODUCTS	180
	PRECISION METAL PRODUCTS CO.	183
	PREM INDUSTRIES, INC.	184
	RELIANT FASTENER	193
	REXNORD INC., TRIDAIR PRODUCTS, ALCOA FASTENING SYSTEMS & RINGS, ARCONIC FASTENING SYSTEMS & RINGS	194, 228, 15, 23
   	RING SCREW WORKS	195





SYMBOL	COMPANY NAME	PAGE
	ROBBINS MANUFACTURING	196
 Rubber stamped on fasteners	ROTAIR INDUSTRIES, INC.	198
 	SANNOHASHI SEISAKUSHO CO., LTD.	202
	SANTA ANA SCREW PRODUCTS INC	203
	SATURN FASTENERS, INC.	203
	SET SCREW & MFG. CO.	205
 	SEMBLEX CORPORATION	204
	SHAMROCK FASTENER TECHNOLOGIES, LLC.	205
	SPS TECHNOLOGIES	213
	STELFAST FASTENERS, INC.	217
	STILLWATER FASTENERS, INC.	219
	STRENKERT MACHINE SHOP INC.	219
	SUNRISE PRECISION MFG.	220
 EARTH	SUPERIOR TECHNOLOGY	220
	SUPREME SCREW PRODUCTS, INC.	220
 	TAIYO NUT MFG. CO., LTD.	221
	TECH WELDING AND MACHINE CO.	222
	TENS MACHINE CO., INC.	223
	TFI AEROSPACE CORPORATION	224
	TOPURA CO., LTD.	226
	TOPURA CO., LTD.	226
	TRI STATE TOOL & DIE CO.	228
	TRIEM INDUSTRIES, LLC	228
	UNITED BOLT & SCREW CORP.	232
	UNITED STEEL & FASTENERS INC.	233



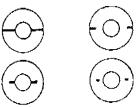
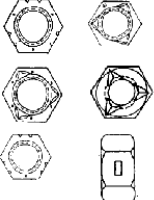
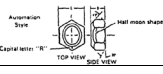
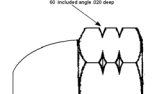

MIL-HDBK-57J (GS7)
INDEX B

SYMBOL	COMPANY NAME	PAGE
	WHAIL BOLT IND. CO., LTD	244
	XCEL MFG., INC.	248
• (a dot)	MONADNOCK COMPANY, THE, LISI AEROSPACE TRW ELECTRONIC COMPONENTS	159
• (a dot) - (radial line)	DECKER MANUFACTURING CORP	69
•• (2 dots)	BELL FASTENERS	38
•• (2 dots)	BRISTOL INDUSTRIES	44
	CUTTING EDGE ENTERPRISE, LLC	66
•• (2 dots)	NORTH EAST FASTENERS	167
•• (2 dots)	STILLWATER FASTENERS, INC.	219
	CSM FASTENER PRODUCTS	65
	EMP MANUFACTURING CO.	81
	ERICO FASTENING SYSTEMS	83
	WOLVERINE NUT CO.	248
•••• 4 dots inline or radial	CAMCAR DIVISION OF TEXTRON INC.	50
	CAMCAR LLC	53
	CAMCAR SCREW AND MFG CO	53
//	BRISTOL LOCKNUT CO.	44
 3 radial lines	CAMCAR DIVISION OF TEXTRON INC.	50
	METALCRAFTERS	153
= 2 parallel lines	CAMCAR DIVISION OF TEXTRON INC.	50
= 2 parallel lines	CAMCAR SCREW AND MFG CO	53
 Three parallel lines spiralex insert products only	MICRODOT INC. KAYNAR PRODUCTS ALCOA FASTENING SYSTEMS & RINGS ARCONIC FASTENING SYSTEMS & RINGS	155, 127, 15, 23
	AMERICAN NUT MANUFACTURING	20
	AMERIFAST CORP.	20

SYMBOL	COMPANY NAME	PAGE
 Manufacturer identification: 2 raised ribs in (2) crimp depressions 1 raised rib in (1) crimp depression	GREER STOP NUT	84, 101
"Dimple" trademark 	PENN ENGINEERING & MANUFACTURING CO.	177
Notches or Stakes cut into corners of nut	EVERLOCK FASTENING SYSTEMS	84
2, 3, or 6 dots on corner of nut	FEDERAL SCREW WORKS	90
4 or 6 dots on flange of flange nuts Company I.D.: 2 single & 1 double slash	INDUSTRIAL & AUTOMOTIVE FASTENERS	117
Dots, slashes, and dots with slashes 2 - 8	R B & W CORPORATION	189, 192
Dots, slashes, and dots with slashes 2 - 8	STELCO FASTENER & FORGING CO.	216
 Under head Top of head Slotted hexhead (top of head)	INDUSTRIAL FASTENERS CORP.	117
 4 - 7 DOTS	LAMSON AND SESSIONS OF CANADA LTD.	133
 3, 4 or 6 equally spaced stakes	INDUSTRIAL NUT CORP.	117
 120° INCLUDED ANGLE RAISED. INDENTED HEX NDS. AND INDENTED HEX WASHER NDS.	LEWIS SREW COMPANY	137
 3 DASH MARKS 120° APART "UNDER HEAD UPON REQUEST "NON-COUNTERSUNK HEADS ONLY"	LEWIS SREW COMPANY	137
 Flange nuts lock and with Uni-Torque® lock Two raised bars	MACLEAN-FOGG CO.	146
TWO RAISED BARS		
Three raised or depressed lines Hex nuts and Uni-Torque® locknuts	THIANT (BOULONNERIE DE SA)	225
	MACLEAN-FOGG CO.	146
	PACIFIC FASTENERS, INC.	173

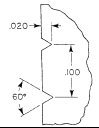
MIL-HDBK-57J (GS7)
INDEX B

SYMBOL	COMPANY NAME	PAGE
	TEXTRON FASTENING SYSTEMS	224
	VMC INDUSTRIES, INC.	239
Two lines in three pads		
	ELCO INDUSTRIES, INC.	78
	GRIPCO, DIVISION OF BLACK & DECKER	101
	RAMCO SPECIALTIES, INC.	191
	RIPPA PRODUCTS	196
	SOUTHERN FASTENING SYSTEMS	209
2 notches for slotted heads only		

SYMBOL	COMPANY NAME	PAGE
	WOLVERINE MACHINE PRODUCTS CO.	247
	SPS TECHNOLOGIES	213
<i>Straight knurls with an unknurled band adjacent to the bearing surface on socket heads. The diameter over the straight knurl does not exceed the band. There may be 2 or 3 grooves.</i>		
	SPS TECHNOLOGIES	213
<i>A raised or depressed triangle pointing from the wrenching flat toward thread on nut products.</i>		
Blue nylon insert	INDUSTRIAL NUT CORP.	117
Blue nylon locking element	NYLOK CORP.	169
Blue - nylon® hexagon locking element	PENN ENGINEERING & MANUFACTURING CO.	177
		
Square insert in floating fasteners	PENN ENGINEERING & MANUFACTURING CO.	177
		
Green nylon insert	GREER STOP NUT	84, 101
Green nylon insert	EVERLOCK FASTENING SYSTEMS	84
Orange nylon insert	AZTECH LOCKNUT CO.	33
Red nylon insert	ELASTIC STOP NUT & ESNA	78, 84, 146
Tan nylon insert	VMC INDUSTRIES, INC.	239
Yellow nylon insert	ABBOTT INTERFAST CORP.	3

3 V FASTENER COMPANY, INC.

320 REED CIRCLE
CORONA, CA 92879-1349

3V

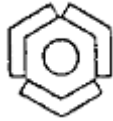

CAGE code: 1ER65

3D MACHINE COMPANY, INC.

4790 E WESLEY DRIVE
ANAHEIM, CA 92807-1941

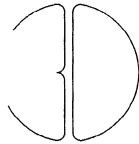

CAGE code: 1K6P6

A & E MACHINED PRODUCTS

93 PECK HILL ROAD
JOHNSTON, RI 02919

AE

CAGE code: 3MAH6

A & G ENGINEERING CO., INC

4640 EAST LA PALMA AVENUE
ANAHEIM, CA 92807



CAGE code: 4N135

A & M AEROSPACE, INC.

2332 SOUTH DELAWARE STREET
DENVER, CO 80223-4321

A & M $\frac{A}{M}$ A/M A&M

CAGE code: 6Z800

A & N PRECISION INDUSTRIES

65 1ST STREET
NEW ROCHVILLE, NY 10801-6118



CAGE code: 9Y423

A & R MFG COMPANY, INC.

1281 JOHN FITCH BLVD.
SOUTH WINDSOR, CT 06074

AR

CAGE code: 3X841

A & S PIN PRODUCTS

42 LAGRANGE ST.
WORCESTER, MA 01610



CAGE code: 39YG0

A & W SCREW MACHINE PRODUCTS, INC.
(LONG-LOK FASTENERS CORPORATION)
20531 S. BELSHAW AVENUE
CARSON, CA 90746-3505



CAGE code: 63035

A. AGRATI S.P.A.
VIA PAIVE 28-30
20837 VEDUGGIO CON COLZANO, ITALY

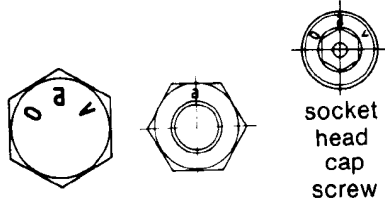

CAGE code: A0698

A.G.H. INDUSTRIES, INC.
1103 STANLEY DR.
EULESS, TX 76040

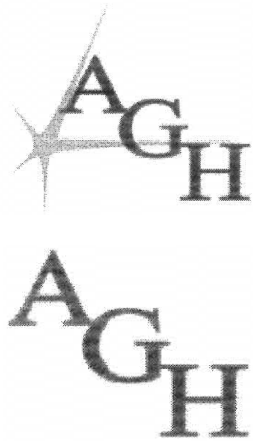

CAGE code: 50888

A.M.I ENGINEERING
2697 S. HALLADAY STREET
SANTA ANA, CA 92705-5617



CAGE code: 4WDB5

A.P. MILLS INDUSTRIES FOR THE BLIND
346 ST. PAUL STREET
P.O. BOX 2175
MEMPHIS, TN 38101 – 2175



CAGE code: 6Y776

A.S. AEROSPACE, INC.
21095 CENTRE POINTE PKWY
SANTA CLARITA, CA 91350



CAGE code: 80JT2

A-1 NUT AND BOLT CO, INC
341 PASEO SONRISA
WALNUT, CA 91789



CAGE code: 1M493

A-1 THREAD ROLLING CO.
7022 ALONDRA BOULEVARD
PARAMOUNT, CA 90723

A-1

CAGE code: 3N586

AAP ACQUISITION CORP.
2100 ENTERPRISE PKWAY
TWINSBURG, OH 44087-2212

A

CAGE code: 0H380

AASTRO ENGINEERING
1382 CORONADO AVE
LONG BEACH, CA 90804

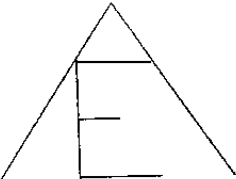

CAGE code: 01AL8

ABBOTT INTERFAST CORP.
190 ABBOTT DRIVE
WHEELING, IL 60090

Yellow nylon insert identifies Abbott-Interfast Corp.
as manufacturer



CAGE code: 08928

ABBOTT, PETER AEROSPACE LTD.
6 REPTON CLOSE
BURNT MILLS, BASILDON,
ESSEX SS13 ILE
UNITED KINGDOM

PAM PAM PAM

CAGE code: 0WL73

ABC TOOL AND DIE ENGINEERING & MANUFACTURING LLC
197 WALLIS STREET
UNIT C
EUGENE, OR 97402-5301

No artwork for marking.
Marks whatever the
customer specifies.



CAGE code: 0XJF0

ABRASIVE CUTTING CORP
633 COMMERCE ST.
THORNWOOD, NY 10594



CAGE code: 5DQB3

<p>ABSCOA INDUSTRIES 1071 WEST ARBOR VITAE ST. INGLEWOOD, CA 90301</p> <p style="text-align: center;">AB</p> <p>CAGE code:</p>
<p>ACCUFORM, INC. P.O. BOX 307 BUS. HWY. 36 WEST MACON, MO 63552</p> <p style="text-align: center;">AF AF</p> <p>CAGE code:</p>
<p>ACCURA INDUSTRIES, INC. 435 TRABOLD ROAD ROCHESTER, NY 14624</p> <p style="text-align: center;"></p> <p>CAGE code: 6RX70</p>
<p>ACCURATE AUTOMATIC PARTS CO. 2885 S. 163RD ST. NEW BERLIN, WI 53151</p> <p style="text-align: center;">AP</p> <p>CAGE code: 5S202</p>

<p>ACCURATE PRECISION FASTENERS, INC. P.O. BOX 5239 ENGLEWOOD, NJ 07631</p> <p style="text-align: center;">Plant 20 HONECK ST. ENGLEWOOD, NJ 07631</p> <p style="text-align: center;">A</p> <p>CAGE code: 28977</p>
<p>ACCURATE SCREW MACHINE CO. P.O. 10095 10 AUDREY PL FAIRFIELD, NJ 07004-3402</p> <p style="text-align: center;">(Plant) 19 Baltimore St. Nutley, NJ 07110</p> <p style="text-align: center;">AMSCO</p> <p style="text-align: center;">5/16 LONG X 1/16 HIGH X .010 DEEP</p> <p>CAGE code: 51506</p>
<p>ACCURATE THREADED FASTENERS, INC. DIVISION OF BEATRICE FOODS CO. 3550 WEST PRATT AVE. LINCOLNWOOD, IL 60645</p> <p>see ATF, INC.</p> <p style="text-align: center;"> </p> <p>CAGE code: 95110</p>

ACCURATE THREADED PRODUCTS CO.
280 HARTFORD AVENUE
NEWINGTON, CT 06111

1A249

CAGE code: 1A249

ACCURATE TOOL CO., INC.
891 FERNHILL RD
WEST CHESTER, PA 19380 - 4282

A+

CAGE code: 7N957

**ACCU-TECH MANUFACTURING AND
SUPPORT, INC.**
8875 EAST AVENUE
MENTOR, OH 44060

Accu-TECH
MFG. & SUPPORT INC.

CAGE code: 1LLG8

ACCUTOOL
5301 IROQUOIS AVENUE
ERIE, PA 16511-2529

01FO

CAGE code: 1UXM0

ACCUTURN CORPORATION
6510 BOX SPRINGS BLVD., UNIT A
RIVERSIDE, CA 92507



CAGE code: 1XYA5

ACE GRINDING & MFG. OF TEXAS
2610 AERO DRIVE
GRAND PRAIRIE, TX 75052 - 7636

AGC

Plant (plant closed)
ACE GRINDING CO INC.
4937 EAST SLAUSON AVENUE
MAYWOOD, CA 90270
CAGE code: 2N509

AGM

Plant (see SHAW PRECISION
GRINDING & THREADING)
SHAW PRECISION GRINDING
6503 W. FRYE RD.
CHANDLER, AZ 85226

SPG

CAGE code: 5U074

ACE PRECISION INDUSTRIES, INC.
925 MOE DRIVE
AKRON, OH 44310-2518



CAGE code: 3DTZ2

ACHILLES AEROSPACE PRODUCTS, INC.
2100 ENTERPRISE PKWY
TWINSBURG, OH 44087-2212

A

CAGE code: 0H380

ACI
301 W. WILSON
P.O. BOX 398
OTTAWA, KS 66067

ACI

CAGE code: 0AV61

ACIMET MFG.
1710 CLARKSTONE RD.
CLEVELAND, OH 44112



CAGE code: 6V869

ACME INDUSTRIAL COMPANY
441 MAPLE AVE
CARPENTERSVILLE, IL 60110



CAGE code: 00175

ACME MACHINE PRODUCTS
500 SOUTH VARNEY STREET
BURBANK, CA 91502



CAGE code: 4M256

ACME RIVET & MACHINE CORP.
50 EMMETT ST.
BRISTOL, CT 06010

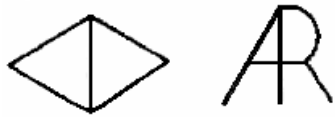

CAGE code: 34482

ACME SCREW COMPANY
1201 W. UNION AVE
WHEATON, IL 60187-4879

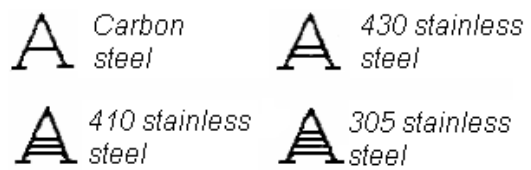

CAGE code: 35EX5

ACRODYNE MFG CO.
41 KINGSTON AVE
COLUMBUS, OH 43207-2438



CAGE code: 9Y179

ACUFAST AIRCRAFT PRODUCTS
12445 GLADSTONE AVE.
SYLMAR, CA 91342

AF



CAGE code: 4GP55

ADAMS INDUSTRIES, INC.
(A SUB OF BANNER INDUSTRIES INC.)
1160 SOUTH ST
WINDSOR LOCKS, CT 06096

ABE

CAGE code: 33823

ADAMS, EARL M. CO
100 PECK HILL RD.
JOHNSTON, RI 02919

CAGE code: 07123

ADC COMMUNICATIONS CORP.
17528 STUDEBAKER RD.
CERRITOS, CA 90703-2637

adc 

CAGE code: 9X383



ADI MANUFACTURING, INC.
33 HAMMOND, BLDG 201
IRVINE, CA 92718

Plant
1243 TRANSIT STREET
POMONA, CA 91766

MC **K**

CAGE code: 0YCU4

ADJUSTABLE BUSHING CORP.
8330 LANKERSHIM BLVD.
NORTH HOLLYWOOD, CA 91605

Panel fastener *Quick-acting pins*

CAGE code: 3V407

ADOM ENGINEERING
131 AVCO ROAD
HAVERHILL, MA 01835-5956

AD **adm**
(used formerly)



CAGE code: 02GZ1

ADVANCE MACHINE WORKS, CORP.
2620 INDEPENDENCE DRIVE
FORT WAYNE, IN 46808



CAGE code: 00576

<p>ADVANCE PATTERN CORP. 18564 FITZPATRICK DETROIT, MI 48228</p> <p>MFR 29839</p> <p>CAGE code: 29839</p>
<p>ADVANCED CNC MANUFACTURING 2313 DESTINY WAY ODESSA, FL 33556</p> <p>A</p> <p>CAGE code: 1YDC9</p>
<p>ADVANCED MACHINING & FABRICATING, INC. 11212 E. 112TH ST. N. OWASSO, OK 74055-4227</p> <p>a</p> <p>CAGE code: 0BD96</p>
<p>ADVANCED MACHINING & TOOLING, INC. 13535 DANIELSON ST. POWAY, CA 92064</p> <p>AMT</p> <p>CAGE code: 1N6C7</p>

<p>ADVANCED MANUFACTURING TECHNOLOGIES, INC. 1090 FALLS ROAD GRAFTON, WI 53024</p>  <p>CAGE code: 0WW78</p>
<p>ADVANCED MACHINING TECHNOLOGIES PO BOX 3351 WARMINISTER, PA 18974</p> <p>Plant 220 JACKSONVILLE RD. HATBORO, PA 19040</p> <p>OF0Y2</p> <p>CAGE code: OF0Y2</p>
<p>ADVANCED PLASTICS, INC. 11212 E. 112th ST. N. OWASSA, OK 74055-4227</p> <p>ap a</p> <p>CAGE code: 45339</p>
<p>AERCO RESEARCH 527 QUEENS LN SAN JOSE, CA 95112</p>  <p>CAGE code: 0KMN9</p>

AERO & AUTO STUD SPEC.

P.O. BOX 140
NEW HUDSON, MI 48165
Plant
56000 GRAND RIVER
NEW HUDSON, MI 48165

Studs \bar{A}

Bolts \bar{A} or \bar{A} & \bar{A}

CAGE code: 5DN08

AERO BUSHING AND COMPONENT

15201 PIPELINE LN.
HUNTINGTON BEACH, CA 92649



CAGE code:

AERO COMPONENTS CO.

5124 KALTENBRUN RD.
FORT WORTH, TX 76119 - 6400



CAGE code: 59213

AERO DYNAMIC MACHINING, INC.

11791 MONARCH STREET
GARDEN GROVE, CA 92841-1818



CAGE code: 1KSM2

**AERO ENGINEERING AND
MANUFACTURING CO. OF CALIFORNIA**

28217 AVENUE CROCKER
VALENCIA, CA 91355-1249



CAGE code: 17772

**AERO MECHANICAL FASTENING
SYSTEMS**

15481 WEST 110TH AVE
SHAWNEE MISSION, KS 66219



CAGE code: 1FY45

AEROBOLT MANUFACTURING, INC.

4736 FELSPAR STREET
RIVERSIDE, CA 92509-3068



CAGE code: 08PH2

AERO-FAB, INC.
8420 RED OAK STREET
RANCHO CUCAMONGA, CA 91730



CAGE code: 0CAC0

AEROFAST SUPPLY
405 W 20TH ST
SAN PEDRO, CA 90731

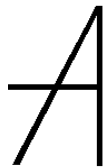

CAGE code: 2T830

AEROMAX INDUSTRIES, INC.
9027 CANOGA AVE, UNIT H & I
CANOGA PARK, CA 91304 - 1541



CAGE code: 40581

AEROMED PRECISION, LLC
4065 S 300 W
SALT LAKE CITY, UT 84107



The uppercase letters "A" and "M" that are slightly overlapping with the "A" in front.

CAGE code: 6WBT1

AEROSPACE MACHINE PRODUCTS
P.O. BOX 3046
CUMMING, GA 30028

Plant
61 PEARL INDUSTRIAL AVE
HOSCHTON, GA 30548



CAGE CODE: 6KBV2

AEROSPACE MANUFACTURING
P.O. BOX 3398
WALLINGTON, NJ 07057-1148

Plant
80 VAN WINKLE AVE.
WALLINGTON, NJ 07057-1148



CAGE code: 0E0Z8

**AEROSPACE MARINE SPECIALTY
FASTENERS & FITTINGS INC.**

1645 WEST 135TH STREET
GARDENA, CA 90249-2505

AMS **A M S**

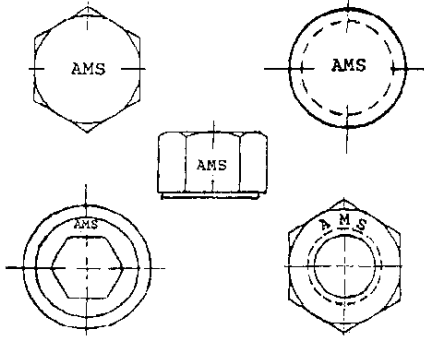

CAGE code: 1FGH9

AEROSPACE PRODUCTS

(DIV OF APCOA FASTENERS, INC)
903 E. OHIO STREET
P. O. BOX 796
INDIANAPOLIS, IN 46202

APCO

CAGE code: 17140

AEROSPACE PRODUCTS CO.

DIV WBH
P.O. BOX 796
INDIANAPOLIS, IN 46206-0796

Plant
123 NORTH PINE STREET
INDIANAPOLIS, IN 46202 - 3844

AP

CAGE code: 59736

AEROSPACE PRODUCTS, INC.

5435 PERKINS RD.
BEDFORD HEIGHTS, OH 44146

A

CAGE code:

AEROSPACE RIVET MFG CORP

8535 DICE ROAD
SANTA FE SPRINGS, CA 90670



CAGE code: 64728

**AEROSTAR ENGINEERING &
MANUFACTURING COMPANY**

25514 S. FRAMPTON AVENUE
HARBOR CITY, CA 90710-2907



No longer a fastener manufacturer

CAGE code: 0MXJ2

AEROSTAR FASTENER CORP.

712 W LACY ST
P.O. BOX 2201
PALESTINE, TX 75802



CAGE code: 0T218

AEROTECH FASTENERS, INC.

ONE RIDGE ROAD
PUTNAM, CT 06260



CAGE code: 0TD46

AEROWIND CORPORATION

1959 JOHN TOWERS AVENUE
EL CAJON, CA 92020-1117



CAGE code: 1N021

AF FASTENERS LIMITED

UNIT 14 & 15
GLOSSOP BROOK BUSINESS PARK,
GLOSSOP, DERBYSHIRE SK13 7AJ,
UNITED KINGDOM



CAGE code:

AFAB PRECISION MACHINING

20742 LINEAR LANE
LAKE FOREST, CA 92630



CAGE code: 1GSW1

AFI INDUSTRIES, INC.

475 E. KEHOE BLVD
CAROL STREAM, IL 60188

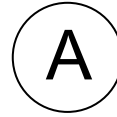

CAGE code: 33PQ1

AIHARA SEIBYO CO LTD

2084 SHIN-MACHI
TANO-GUN, GUNMA, JAPAN 370-13



CAGE code:

AIR INDUSTRIES CORPORATION

12570 KNOTT STREET
GARDEN GROVE, CA 92841-3932



CAGE code: 06725

AIR LAND TURBINE SERVICES, INC
7425 AIRPORT FREEWAY
FORT WORTH, TX 76118



CAGE code: 1K1L5

AIR PARTS MFG. CO.
1117 HARRISON AVE
ARLINGTON, TX 76011



CAGE code: 8R401

AIR-COM, INC.
18105 S. HOBART BLVD.
GARDENA, CA 90248-3617

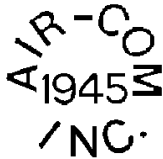

CAGE code: 2Y870

AIRCRAFT ENGINEERING PRODUCTS, INC.

2 ACKERMAN AVENUE
CLIFTON, NJ 07011

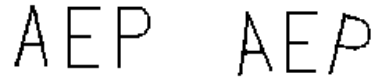

CAGE code:

AIRCRAFT FUELSEAL FASTENERS, INC.

5271 ARGOSY AVENUE
HUNTINGTON BEACH, CA 92649



CAGE code: 4K209

AIRDROME PARTS CO.

3251 SCHNIEDER ROAD S.E.
P.O. BOX 1867
NORTH CANTON, OH 44720



CAGE code:

AIRFASCO, INC.

2655 HARRISON AVE SW.
CANTON, OH 44706-3047



CAGE code: 3Z958

MIL-HDBK-57J (GS7)
APPENDIX A

AIRFASCO INDUSTRIES FASTENER GROUP

2655 HARRISON AVE.
CANTON, OHIO 44706

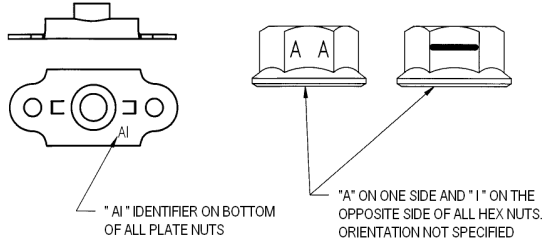

"AI" IDENTIFIER ON BOTTOM OF ALL PLATE NUTS

"A" ON ONE SIDE AND "I" ON THE OPPOSITE SIDE OF ALL HEX NUTS. ORIENTATION NOT SPECIFIED

CAGE code: 5NYP9

AIRFRAME INTERNATIONAL, INC.

3150 AIRMANS DRIVE
FORT PIERCE, FL 34946 - 9131

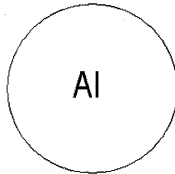

CAGE code: 3ZKC5

AIW-ALTON INC.

1475 PALISADO AVE.
WINDSOR, CT 06095-5140



CAGE code: 84027

AJ ASSOCIATES MANUFACTURING & ENGINEERING COMPANY, INC.

11346 53rd STREET NORTH
CLEARWATER, FL 33760 - 4821

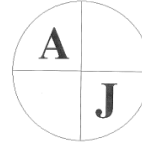

CAGE CODE: 3Z260

AKKO FASTENER, INC.

6855 CORNELL RD.
CINCINNATI, OHIO 45242 - 3022



CAGE code: 3M2H6

ALAN, JEFFREY, MFG. & ENGR.

8625 LAPEER ROAD
P.O. BOX # 8
GOODELLS, MI 48027-9766

3D531

CAGE code: 3D531

ALARD MACHINE PRODUCTS

1629 WEST 132ND STREET
GARDENA, CA 90249-2005



CAGE code: 1FMQ2

ALBAR MACHINE CORPORATION

126 TALBOT DRIVE
EFFORT, PA 18330-9450

AMC

CAGE code: 44248

ALCO MACHINE CO.

27 SEARING AVENUE
HARRISON, NJ 07029

A-1

CAGE code: 2T918

ALCOA FASTENING SYSTEMS & RINGS

3000 WEST LOMITA BLVD.
TORRANCE, CA 90505

NAME CHANGED TO:
ARCONIC FASTENING SYSTEMS & RINGS

see ARCONIC FASTENING SYSTEMS &
RINGS

CAGE code: 92215

ALCOA GLOBAL FASTENERS INC

110 N UNRUH AVE
CITY OF INDUSTRY ,CA 91744

COMPANY CHANGED/MOVED

see ARCONIC FASTENING SYSTEMS &
RINGS

○

CAGE code: 06950

**ALEXANDER MANUFACTURING
COMPANY INC**

see METRO TOOL & MANUFACTURING
CO.

2402 ARKANSAS LANE
GRAND PRAIRIE, TX 75052-7203

MT

CAGE code: 2M919

ALL AUTOMATICS

8222 SORENSEN AVENUE
SANTA FE SPRINGS, CA 90670

A
A

CAGE code: 0SSY5

ALL MANUFACTURERS INC.

ALLIED HARBOR AEROSPACE
FASTENERS
2900 PALISADES DR
CORONA, CA 92880 – 9429

AOL

CAGE code: 57472

ALL PINS MANUFACTURING

P.O. BOX 137
WILSEYVILLE, CA 95257

plant
5549 POOR MANS WAY
WILSEYVILLE, CA 95257

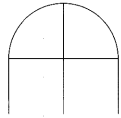

CAGE code: O8CZ5

ALLFAST FASTENING SYSTEMS, INC.

15200 E DON JULLIAN RD
CITY OF INDUSTRY, CA 91745-1001



CAGE code: 53551

ALLIED NUT & BOLT CO., INC.

520 HERTZOG BOULEVARD
P.O. BOX 670
KING OF PRUSSIA, PA 19406-2667

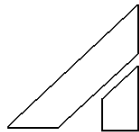

CAGE code: 4S191

ALLIED PRECISION PRODUCTS, INC.

600 SAN CHRISTOPHER DRIVE
DUNEDIN, FL 34698-5095



CAGE code: 24249

ALL-POWER MFG. CO.

13141 MOLETTE STREET
SANTA FE SPRINGS, CA 90670-5500



CAGE code: 70265

ALL-PRO FASTENER & RIVET MFG. CO.

10406 ENTERPRISE ST
P.O. BOX 1525
RANCHO CUCAMONGA, CA 91730



CAGE code: 1FH10

ALL-STATES INC.

602 N 12TH STREET
SAINT CHARLES, IL 60174



ALL-STATES LOGO



ALL-STATES
IDENTIFICATION MARK

CAGE code: 26863

ALLTECH INDUSTRIAL, LLC
4730 HAMMERMILL ROAD, STE A
TUCKER, GA 30084

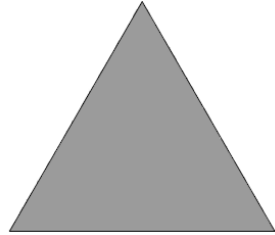

CAGE code: 6UL39

ALPHA BOLT CO.
1524 EAST 14 MILE ROAD
MADISON HEIGHTS, MI 48071

ABC

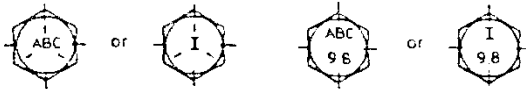

GRADE 5 BOLT

PROPERTY CLASS 9.8
METRIC BOLTS

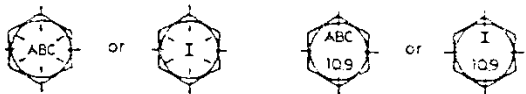
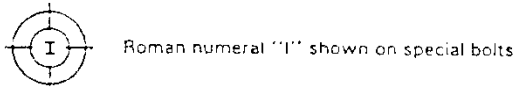

GRADE 8 BOLT

PROPERTY CLASS 10.9
METRIC BOLTS

CAGE code: 0R8B6

ALPHA FASTENERS COR.
154 EAST MERRICK ROAD
FREEPORT, NY 11520



CAGE code: 1UJ18

ALPHA MACHINING PRODUCTS & DEVELOPMENT

8651 PRODUCTION AVENUE
SAN DIEGO, CA 92126

Plant
7929 SILVERTON AVENUE
SUITE 610
SAN DEIGO, CA 92126



CAGE code: 3D6Q0

ALPINE MACHINE & TOOL CORP.

42 BERGENLINE AVE.
WESTWOOD, NJ 07675

AMT - I

AMT xxxx-xxxx



CAGE code: 67339

ALPS SEIKO CO. LTD.

41 HIGASHI-KANAE, KANAE
IIDA-SHI, NAGANO PREF.
395-0817, JAPAN

Plant
LIDA FACTORY
524-1, SHIMOTONOHKA
LIDA-SHI, NAGANO PREF.
395-0154 JAPAN

A

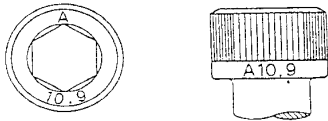

CAGE code:

AMACON CORP.

49 ALDER STREET
WEST BABYLON, NY 11704



CAGE code: 54330

AMANDA BENT BOLT COMPANY

1120 C I C DR.
LOGAN, OH 43138-9153



CAGE code: 22382

AMATOM ELECTRONIC HARDWARE

5 PASCO HILL ROAD, UNIT B
CROMWELL, CT 06416-1012

A
M
A
T
O
M
AMATOM

CAGE code: 1YGB8

AME SWISS MACHINING LLC

811 GERBER ST.
LIGONIER, IN 46767

Plant
711 GEREBER ST
LIGONIER, IN 46767



CAGE code: 6TED2

AMERI-CUT SOLUTIONS

9961 CASSOWARY DR.
CONROE, TX 77385

ACS

CAGE code: 7SQ53

AMERICA AEROSPACE PRECISION MFG.

26254 HWY 281 NORTH
SAN ANTONIO, TX 78258

1S5U7

CAGE code: 1S5U7

**AMERICAN AIRCRAFT PARTS
MANUFACTURING COMPANY**

17917 MASONIC
FRASER, MI 48026

99106

CAGE code: 99106

**AMERICAN ELECTRIC CONSTRUCTION
MATERIALS GROUP**

1555 LYNNFIELD ROAD
MEMPHIS, TN 38119

(see THOMAS & BETTS CORPORATION
(FORMERLY AMERICAN ELECTRIC))

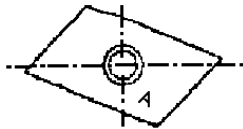

CAGE code: 56501

AMERICAN FASTENER & SPECIALTY CO.

5900 PARK AVE.
CLEVELAND, OHIO 44105



CAGE code:

**AMERICAN INTERNATIONAL AERO MFG
INC.**

6973 SOUTH 300 WEST
MIDVALE, UTAH 84047



CAGE code: 0RBVB

AMERICAN METAL BEARING COMPANY

7191 ACACIA AVENUE
GARDEN GROVE, CA 92841

AMB



HEX SOCKET HEAD
SCREW

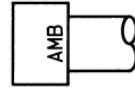

HEX SOCKET HEAD
SCREW



THREAD
OR
STUD END



HEX HEAD
SCREW
OR BOLT



HEX NUT



HEX NUT

CAGE code: 70508

AMERICAN NUT MANUFACTURING

BURNSVILLE PLANT
1113 CLIFF RD E
BURNSVILLE, MN 55337

SOUTH PLAINFIELD PLANT
104 SYLVANIA PL
SOUTH PLAINFIELD, NJ 07080
cc 0H4S0

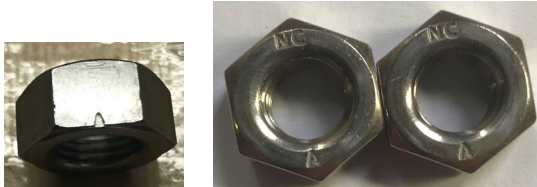

CAGE code: 8E2E6

AMERICAN PRIDE FASTENERS, LLC

195 S. FEHR WAY
BAY SHORE NY 11706



CAGE code: 35WL2

AMERICAN QUALITY MFG INC.

411 BURNHAM STREET
EAST HARTFORD, CT 06108



GRADE 8 BOLT



GRADE 5 BOLT

CAGE code: 1P581

AMERIFAST CORP.

(see American Nut Mfg cc 0H4S0)

104 SYLVANNA RD.
SOUTH PLAINFIELD, NJ 07080-1448

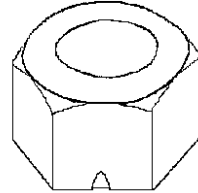

CAGE code: see American Nut Mfg

AMERITECH DIE & MOLD SOUTH INC.

1 EAST TOWER CIRCLE
ORMOND BEACH, FL 32174

AD&M

CAGE CODE: 5HPY1

AMERITECH FASTENER MFG INC.

6606 N GESSNER
HOUSTON, TX 77040

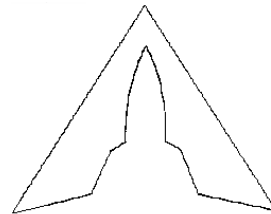

CAGE code: 0EUH2

AMMAC, INC.
6000 SUSQUEHANNA PLAZA
YORK, PA 17406



CAGE code: 0NHU1

ANATASE PRODUCTS
1314 GOODRICK DR
TEHACHAPI, CA 93561

0MXJ8

OJ8 

CAGE code: 0MXJ8

ANCHOR BOLT & SCREW CO.
2001 N. CORNWELL
MELROSE PARK, IL 60160-1081



Hex cap and indented
hex screws.



Machine screws and
Other products -
3 dots under head
120° apart

CAGE code: 9C864

ANDERSON FORGE & MACHINE
18500 S. W. PACIFIC HWY
TUALATIN, OR 97062



CAGE code: 7X566

ANDROCK HARDWARE CORPORATION
711 19th STREET
ROCKFORD, IL 61104



FILLED OVAL, .10" WIDE, .19" LONG

CAGE: 0PD50

ANILLO INDUSTRIES, INC.
2090 N. GLASSELL
P.O. BOX 5586
ORANGE, CA 92865-3306



CAGE code: 10630

ANKIT FASTENERS PRIVATE LIMITED
297 HARAGADDE VILLAGE, ROAD NO. 4
JIGNI INDUSTRIAL ESTATE PHASE - I
BANGALORE 562 106, INDIA

AF

CAGE code: SEM10

ANOTHER SCREW MACHINE PRODUCT
EMERALD INDUSTRIAL PARK BOX 425
PONDERAY, ID 83852

BEI

CAGE code: 05RQ3

ANTRIM MACHINE PRODUCTS, INC.
P.O. BOX 379
MANCERLONA, MI 49659

Plant
9142 JOHNSON RD.
MANCERLONA, MI 49659

AMP

CAGE code: 7U154

A-ONE MACHINE COMPANY
R.R.1, BOX 1660
HOP BOTTOM, PA 18824

A

CAGE code: 0AV84

APEL LTD.

COUNTESS AVE., STANLEY GREEN
TRADING ESTATE
CHEADLE HULME, CHESHIRE, SK8 6QU
UNITED KINGDOM

**A
P
4
C
H**

CAGE code: K5640

APEX MFG. CO. INC.

11686 TUXFORD ST
SUN VALLEY, CA 91352-3134

AP

CAGE code: 2V343

APHEONIX CORPORATION

101 PECK HILL ROAD
JOHNSTON, RI 02919

AP

PC

CAGE code: 08TF3

ARCHER SCREW PRODUCTS

11341 MELROSE STREET
FRANKLIN PARK, IL 60131

+

CAGE code: 1HXL9

ARCO SALES CO.

1230 E MERMAID LN
GLENSIDE, PA 19038 - 7667

ASC
ASC

CAGE code: 5L063

ARCONIC FASTENING SYSTEMS & RINGS

3000 WEST LOMITA BLVD.
TORRANCE, CA 90505-5103

CAGE code: 92215

Plants:

CARSON OPERATIONS
900 EAST WATSON CENTER ROAD
CARSON, CA 90745-4201

⌘

CAGE code: 17446

CITY OF INDUSTRY OPERATIONS

135 NORTH UNRUH AVENUE
CITY OF INDUSTRY, CA 91744-4409

VS O SC

CAGE code: 1RC86

(Continued)

(Continued)

FREE ZONE MIDPARC

CP 27209 NOUACEUR
CASABLANCA, MOROCCO

.M

.M

CAGE code:

FULLERTON OPERATIONS PLANT 1

800 SOUTH STATE COLLEGE BOULEVARD
FULLERTON, CA 92831

K II

K K

K

CAGE code: 15653, 66776

HILDESHEIM OPERATIONS

STEVEN 3
31135
HILDESHEIM-BAVENSTEDT, GERMANY

VS

CAGE code: C4293

(Continued)

(Continued)

KELKHEIM OPERATIONS
INDUSTRIESTRASSE 6
D-65779
KELKHEIM, GERMANY



CAMLOC

CAGE code: D0680

LEICESTER OPERATIONS
VIKING ROAD
WINGSTON, LEICESTER
LE18 2BL
UNITED KINGDOM

NB

CAGE code: U6683

NEMESVÁMOS OPERATIONS
DOZSA GYORGY, U.2/A
NEMESVÁMOS 8248
HUNGARY



CAGE code: 0725V

NEWBURY PARK OPERATIONS
1300 RANCHO CONEJO BOULEVARD
NEW BURY PARK, CA 91320-1405

R

CAGE code: 52828, 71087

(Continued)

(Continued)

REDDITCH OPERATIONS
CROSSGATE ROAD, PARK FARM
REDDITCH, WORCESTERSHIRE
B98 7TD
UNITED KINGDOM

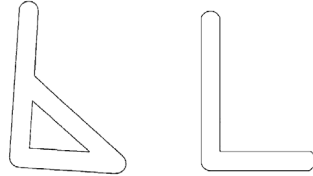

CAGE code: K8753

ST. COSME OPERATIONS
9, RUE DES CRESSONNIERES
72110 SAINT-COSME-EN-VAIRAIS
FRANCE

SD

CAGE code: F0224, FAPP9

SYLMAR OPERATIONS
12975 BRADLEY AVENUE
SYLMAR, CA 91342-3830



CAGE code: 06710, 23899

(Continued)

(Continued)

TORRANCE OPERATIONS
3000 WEST LOMITA BOULEVARD
TORRANCE, CA 90505-5103



CAMLOC



CAGE code: 71286, 75237, 0CBU7, 83324, 29372,
5M902

TOULOUSE OPERATIONS
BOULEVARD DU GRAND CASTAING
ROQUES-SUR-GARONNE
31128 PORTET SUR GARONNE
TOULOUSE, FRANCE



CAGE code: F7411

TUCSON OPERATIONS
3724 EAST COLUMBIA STREET
TUCSON, AZ 85714-3415



CAGE code: 0HDW7

(Continued)

(Continued)

US OPERATIONS
BP 4
CLOS D'ASSEVILLE
95450 US PARVIGNY
FRANCE



CAGE code: F6167

WACO OPERATIONS
8001 IMPERIAL DRIVE
WACO, TX 76714-8117



CAGE code: 9K475

ARDOR MFG. INC.
400 S. 1100 W.
PROVO, UT 84603



CAGE code: 0CTH5

ARGARWAL INDUSTRIES

370 MARSHALL HOUSE
25 STRAND ROAD
CALCUTTA, INDIA 700 001



CAGE code:

ARJAY PRECISION, INC.

72 WINDERMERE AVE
WLLINGTON, CT 06029 - 3838

MFR - 72905

CAGE code: 72905

ARMSTRONG ATLAS BOLT

STATION STREET
DARLASTON, WEST MIDLANDS, WS10 8UL
UNITED KINGDOM

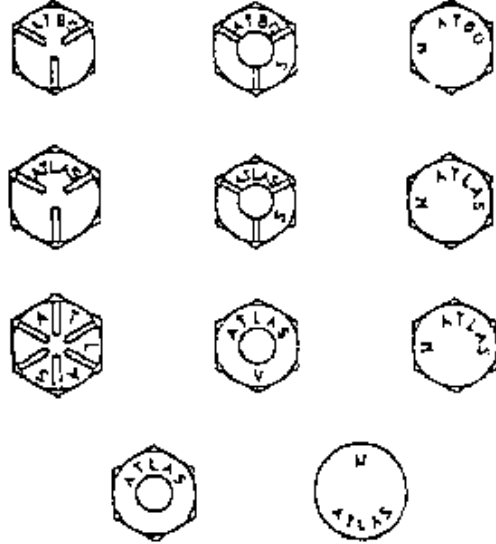

CAGE code:

ARMSTRONG PRECISION COMPONENTS LTD.

FOSTER STREET STONEFERRY
BUSINESS PARK
HULL, HU8 8BT
UNITED KINGDOM



Symbol may
be depressed
or raised

GSF



CAGE code: K1012

ARNOLD KNIPPING GmbH

58557 KIERSPE
POSTFACH 14 48
GUMMERSBACH, GERMANY 5270

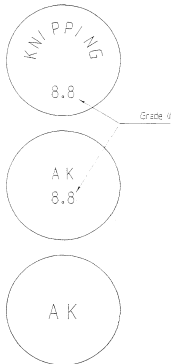

AK
KNIPPING

CAGE code: C4096

ARNOLD UMFORMTECHNIK

GMBH & CO. KG

SINDRINGEN STR. 25
FORCHTENBERG, 74670
GERMANY



CAGE code: C3705

ARNOLD WRAGG (BOLTS & NUTS) LTD

PARKWAY ONE BUSINESS CENTRE
PARKWAY DRIVE, UNIT 2
SHEFFIELD S9 4WU
UNITED KINGDOM



CAGE code: U2935

ARROW SCREW & MACHINE WORKS

1037 GERMANTOWN AVENUE
PHILADELPHIA, PA 19123-1629



CAGE code: 03632

ARTISAN SPECIALIST TECH

439 HIGH STREET
P.O. BOX 48060
PHILADELPHIA, PA 19144



CAGE code: 0RJ65

ARVAN, INC.

14083 S NORMANDIE AVE
GARDENA, CA 90249

ARVAN, INC.

TANSEY

A/I

CAGE code: 29965

ASAHI SREWS MANUFACTURING CO., LTD

101 KAWAMATA
HIGASHIOSAKA, JAPAN

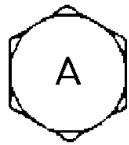

CAGE code:

ASAI TEKKO CO. LTD

2-14 TAJIKA SHODKAI
HIRKATA-SHI OSAKA, JAPAN 573

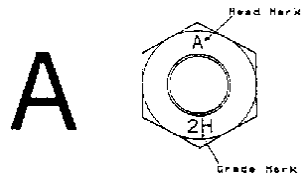

CAGE code:

ASI DESIGN & MANUFACTURING, INC.

1070 HARDEES DRIVE
P. O. BOX 957
ABERDEEN, MD 21001



CAGE code: 32971

ASL MANUFACTURING INC.

60 S. POSADO CT.
IVINS, UT 84738 – 6009

Plant
1074 W. 560N.
ST. GEORGE, UT 84770

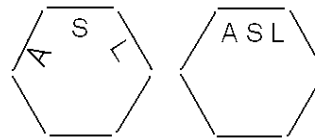

CAGE code: 1VED5

ASSOCIATED TOOL CO., INC.

100 THOMAS DRIVE
GADSDEN, AL 35901 – 8676

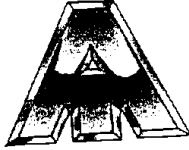

CAGE code: 2U575

AST ASSOCIATES, INC.

14 BETHEL ROAD
GRISWOLD, CT 06351 – 8901

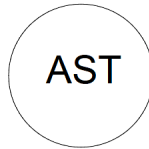

CAGE code: 0WVW0

**ATELIERS DE LA HAUTE-GARONNE
(AHG)**

Z.I DE FLOURENS
26 ROUTE DE LASBORDES
31130 FLOURENS, FRANCE

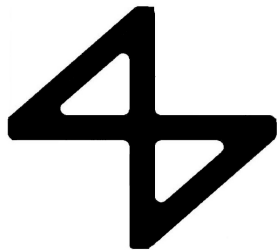
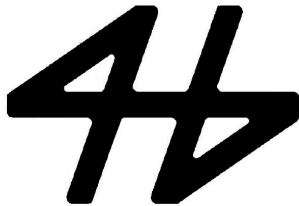

CAGE code: F0095

ATF AEROSPACE

2609 N. OGDEN
MESA, AZ 85215

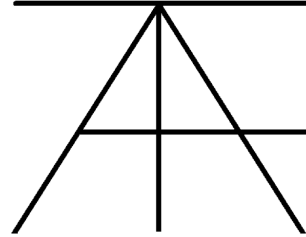

CAGE code: 6XGY8

ATF, INC.

3550 WEST PRATT AVENUE
LINCOLNWOOD, IL 60712 - 3745



CAGE code: 95110

ATHENA INDUSTRIES

11710 SOUTHLAKE DRIVE, UNIT 57
HOUSTON, TX 77077 – 6730

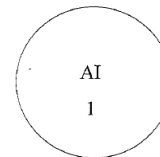

CAGE CODE: 5YJF9

ATLANTA ROD & MANUFACTURING

144 SHOCKBETON RD.
LAVONIA, GA 30553

ATLROD

CAGE code: 6P7X4

ATLANTIC PRECISION SPRING INC.

125 RONZO RD.
BRISTOL, CT 06010

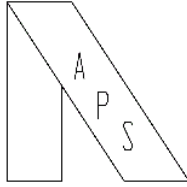

CAGE code: 6D788

ATLAS SPECIALTY PRODUCTS

2299 E. WINSTON ROAD
ANAHEIM, CA 92806



CAGE code: 0TP31

ATOMATIC MANUFACTURING COMPANY

300 SHADELAND AVENUE
EAST PITTSBURG, PA 15112 – 1432



CAGE code: 18362

AUGUST FRIEDBERG GMBH

BELFORTER STRASSE 63
P. O. BOX 10 08 43
GELSENKIRCHEN, GERMANY 45884



CAGE code:

AUGUST FRIEDBERG GmbH

BELFORTER STRASSE 63
D-4650 GELSENKIRCHEN
ROTHAUSEN, GERMANY



CAGE code:

AURORA DEFENSE GROUP

401 HANKES AVE
AURORA, IL 60505



CAGE code: 5A910

AUTO BOLT CO.

4619 PERKINS AVE
CLEVELAND, OH 44103

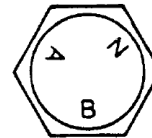
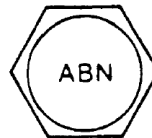

CAGE code: 0CUJ9

AUTOMATED MANUFACTURING
8009 AUGUSTA ROAD
PIEDMONT, SC 29673-9369

AM



CAGE code: 1URY9

AUTOMATIC MACHINING AND MFG CO.
6000 SUSQUEHANNA PLZ
YORK, PA 17406

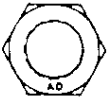
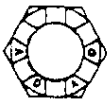

CAGE code: 0NHU1

AUTOMATIC SCREW MACHINE PRODUCTS COMPANY
709 2ND AVE
P.O. BOX 1608
DECATUR, AL 35601 - 2517

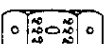
PLAIN:	SLOTTED:	DRILLED:
		
	OR	
		
AD	AD	AD

CAGE code: 92595

AUTO SCREW, INC.
LYNBROCK RD. & EASTERN BLVD.
P.O. BOX 4968
BALTIMORE, MD 21220



CAGE code: 84253

AUTO-VALVE, INC.
1707 GUENTHER RD.
DAYTON, OH 45417



CAGE code: 91511

AVDEL INTERNATIONAL (AVDEL LTD)
HERTFORD, AL 7 1EZ
UNITED KINGDOM



CAGE code:

AVIATION MANUFACTURING GROUP LLC

719 WALNUT ST
P. O. BOX 57
YANKTON, SD 57078 – 3542

F

CAGE code: 84596

AVIBANK MANUFACTURING, INC.

11500 SHERMAN WAY, P.O. BOX 9909
NORTH HOLLYWOOD, CA 91609-1909

**AB
ADB, ADBB, ADP, LRA
AAP
AS
AV
AVIBANK, BALL-LOK®, BLC,
BLS, PIP
AVL
AVK, ET, ETC, FN, IT, ITC,
MT, RT
ST
84256**

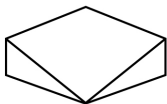

CAGE code: 84256

AVK INDUSTRIES PRODUCTS INC.

4650 SW MACADAM AVE. SUITE 440
PORTLAND, OR 97239-4262

Plant
25323 RYE CANYON RD
VALENCIA, CA 91355

AVK AVK AVK AVK

AK AvK AVK

CAGE code: 78276

AXIAL GLOBAL LLC

431 E AIRTEX DRIVE
HOUSTON, TX 77073

AXL



CAGE code: 967X0

AZAD ENGINEERING PVT LTD

PLOT No 90/C, 90/D PHASE 1
IDA, JEEDIMETLA
HYDERABAD, TELANGANA
INDIA 500055

AZAD



CAGE code: 3106Y

AZTECH ENGINEERING, INC.

1424 CENTRE CIR.
DOWNERGROVE, IL 60515



CAGE code: 0W426

AZTECH LOCKNUT COMPANY

2675 WHITE OAK CIRCLE
AURORA, IL 60502

Orange nylon insert



CAGE code: 5CQW8

B & B ELECTRO-MECHANICAL

66D OTIS STREET
WEST BABYLON, NY 11704



CAGE code: 0UNG2

B & B SPECIALTIES INC.

4321 E. LAPLMA AVE.
ANAHEIM, CA 92807

- 1) PRIMARY - **BB**
- 2) SECONDARY - **62206**

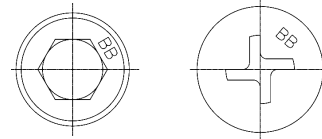

Depressed BB.

CAGE code: 62206

B & D THREADED ROLLING INC

36820 VAN BORN ROAD
P.O. BOX 275
WAYNE, MI 48184



CAGE code: 00LR8

**B & E MACHINE SHOP & SHEET METAL
FAB., INC.**

3059 SE MONROE ST.
STUART, FL 34997



CAGE code: 8W179

B & E MANUFACTURING CO., INC.

12151 MONARCH STREET
GARDEN GROVE, CA 92841 - 2927



CAGE code: 59680

B & G MANUFACTURING CO., INC.

3067 UNIONVILLE PIKE
P.O. BOX 269
HATFIELD, PA 19440-1822

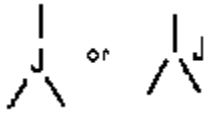

Grade 5

JB7	Grade B7
JB16	Grade B16
JNC	Alloy 400

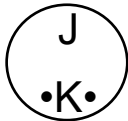

Alloy 500

J4	Grade 4
J2H	Grade 2H

CAGE code: 84272

B & N TOOL CO., INC.

44 ROCKWELL ROAD
NEWINGTON, CT 06111



CAGE code: 0CMJ0

B & R MACHINE AND TOOL CORP

717 MAIN STREET
WESTBURY, NY 11590



CAGE code: 66936

B F GOODRICH CO. RIVNUT ENGINEERED FASTENERS

THE AEROSPACE AND DEFENSE
DIVISION
250 NORTH CLEVELAND-MASSILLION RD.
AKRON, OH 44313

Plant
150 SPRINGSIDE DRIVE
AKRON, OH 44313-0501



CAGE code:

B G ENGINEERING, INC.

205 ARENA STREET
EL SEGUNDA, CA 90245



CAGE code: 0WL62

B G M FASTENER CO., INC.

RR 5 BOX 1675
759 OLD WILLOW AVENUE
HONESDALE, PA 18431

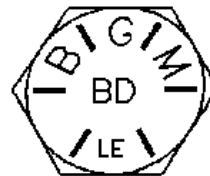

CAGE code: 3Y498

**B. V. FABRIEK VAN KLINGNAGELS EN
SCHROEFBOUTEN V/H SMIT**

2980 GB RIDDERKIRK
P.O. BOX 4075
THE NETHERLANDS

JS

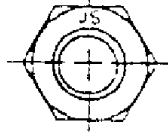

CAGE code:

BARCO ENGINEERING COMPANY, INC.

505 W MAIN ST
TILTON, NH 03276



CAGE code: 29214

BARNEGAT BAY NSCC, INC.

6432 DEVONSHIRE DRIVE
FORT WORTH, TX 76180



CAGE code: 1SDGE

BARRE PRECISION PRODUCTS INC.

199 HOPRIVER ROAD RTE. 6
BOLTON, CT 06043 - 7443



CAGE code: 7R902

BAS AEROSPACE LIMITED

2 CRAMPTONS ROAD
SEVENOAKS, KENT N14 5EF
UNITED KINGDOM

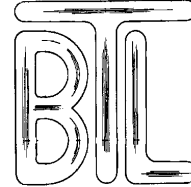

CAGE code: KCWE1

BAUER & SCHAURTE KARCHER GMBH

FURTHER STRASSE 24-26
POSTFACH 10 01 55
D-4040 NEUSS 1
FEDERAL REPUBLIC OF GERMANY



INBUS®

VERBUS® KARRO®

CAGE code: D2370

BAY BOLT

4610 MALAT STREET
OAKLAND, CA 94601

CAL

CAGE code:

BAY SWISS MANUFACTURING

5 AIRPARK VISTA BLVD.
DAYTON, NV 89403

BSM

CAGE code: 28271

BBC FASTENERS, INC.

4210 SHIRLEY LANE
ALSIP, IL 60658

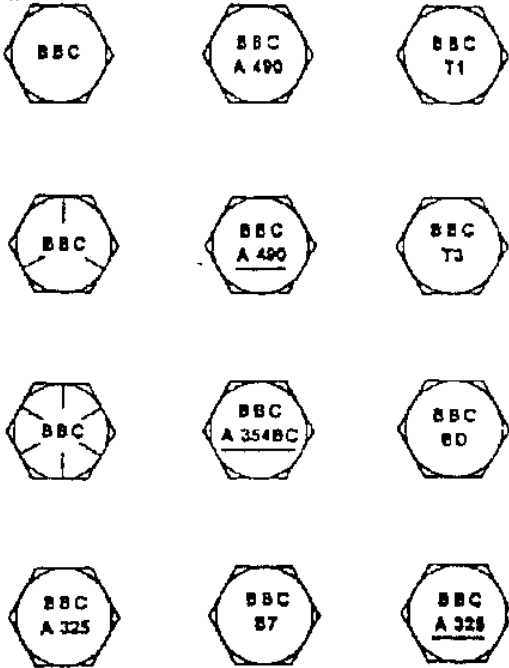

BBC

CAGE code:

BEACH MACHINE

819 WALKER LN
NEW MARKET, AL 35761



CAGE code: 0TCD0

BEAVER PRODUCTS CORP.

P.O. BOX 17279
ANAHEIM, CA 92817

B.P.C.

CAGE code: 4P584

BEC MACHINE PRODUCTS

100 CHRISTOPHER LN.
HARLEYSVILLE, PA 92806 – 1823

BEC

CAGE code: 0JC12

BEE INDUSTRIES, INC.

W6331 BEE ROAD
WATERTOWN, WI 53098

BI

CAGE code: 7V765

BEGONIA TOOL COMPANY

573 HERMINE RD
HERMINIE, PA 15637 – 1721

BT

CAGE code: OL3V3

BEK, INC.

DBA LEVEL 1 FASTENERS
777 10TH AVENUE WEST
HUNTINGTON, WV 25701



300 SERIES STAINLESS STEEL



TYPE 316 STAINLESS STEEL

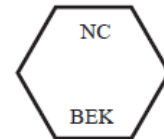

NICKEL COPPER (MONEL)

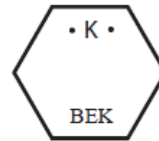

NICKEL COPPER ALUMINUM (K-MONEL)

BEK

CAGE code: 17283

BEK LEVEL 1 FASTENERS

300 THIRD AVE
HUNTINGTON, WV 25701



300 Series Stainless Steel

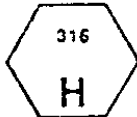

Type 316 Stainless Steel

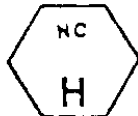

Nickel Copper (Monel)



Silicon Bronze

BEK LEVEL 1 FASTENERS
721 EAST COMPTON BOULEVARD
COMPTON, CA 90220

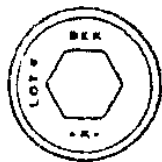

BEK

CAGE code:

BEL-AIR MACHINE & PERFORMANCE

14181 FIR STREET
OREGON CITY, OR 97045 - 6806



CAGE code: 5SJL1

BELL FASTENERS

327 PINE STREET
PAWTUCKET, RI 02862

S

STILLWATER

B

BELL

PMC

PAWTUCKET MANUFACTURING CO.

P

PAWTUCKET

A

ALBANY

SW

ON TOP OF SCREW



(two dots) On the top of or bearing surface
of the screw

(SEE VERTEX)

CAGE code: 12360

BELL-MEMPHIS, INC.
1650 CHANNEL AVE
MEMPHIS, TN 38113-01871



CAGE code: 22277

BELL PRECISION, INC.
169 N DILLON AVENUE
SAN JACINTO, CA 92583 - 3909



CAGE code: 56122

BEN YUAN ENTERPRISE CO, LTD.
NO. 113, CHI-NAN ROAD
TAI-SHIA VILLAGE, KAOHSIUNG HSIEN,
TAIWAN R. O. C.



CAGE code:

BENACO TOOLING R AND D CORP
9287 MERCANTILE DR
MENTOR, OH 44060



CAGE code: 5W644

BEOTOOL CORP.
725 WHITNEY DR
BLUE BELL, PA 19422 - 1205



CAGE code: 2N084

BERGNER, RICHARD GMBH & CO. KG
BAHNHOFSTRAUSSE 8-16
P.O. BOX 1180
SCHWABACH, 91126
GERMANY



Where required and applicable, these fasteners types are also marked with the logo "RIBE" and/or capital "B" with screw in circle.



CAGE code: D2282

BER-LOW MFG INC.

4928 PITTSBURGH AVE
ERIE, PA 16509

see BUTECH PRESSURE SYSTEMS



CAGE code: 62295

BERRY MANUFACTURING

5505 BREWSTER ST
SAN ANTONIO, TX 78233



CAGE code: 65003

BETA CORP.

2332 S DELAWARE ST
DENVER, CO 80223 - 4321



CAGE code: 06671

BETA ENGINEERING, INC.

P.O. BOX 80
468 DODSON LAKE DRIVE
ARLINGTON, TX 76012 - 3441



CAGE code: 33436

BIG BOLT CORP.

140 COVINGTON DRIVE
BLOOMINGDALE, IL 60108 - 3105

BB

BB

BB

•

BB

•

BB

•

CAGE code: 3Q6H0

BIRANT MAKINA LTD STI

AGAC METAL SAN SIT1436 SOK NO32
IVEDIK ORGANIZE SANAYI BOLGESI
ANKARA, 06000 TURKEY



CAGE code: T7652

BISHOP ENTERPRISES, INC.

3 EAST BISHOP STREET
WATERFORD, CT 06385 - 2513



CAGE code: 6Y882

BLAINE TOOL CORP.
5024 FALL CREEK RD
INDIANAPOLIS, IN 46220 – 5344



CAGE code: 17027

BLANC AERO INDUSTRIES
see LISI AEROSPACE

BLANC AERO INDUSTRIES
193 R DE BERCY
PARIS, FRANCE 75012

BLANC AERO INDUSTRIES
SAINT CHAMOND GRANAT
18 20 RUE S-HILAIRE
SAINT OUEN L'AUMONE, FRANCE 95310

P (Sr Brieuc)
B (Paris)
P (Villefranche de
Rouergue)
ds. F

T

BLANC AERO INDUSTRIES
DECOLLETAGE MODERNE
5 BIS, PLACE LEON BLUM
75020 PARIS, FRANCE

DDG

CAGE code: F0188

BLANC AIRCRAFT FASTENERS, INC.
203020 PRARIE ST
P.O. BOX 3819
CHATSWORTH, CA 91842



BAF

CAGE code:

BLAND CO., THE
55 BROOK ST
P. O. BOX 330358
WEST HARTFORD, CT 06133

BL

CAGE code: 02991

BLUE TEE CORP DBA GEFCO
2215 S. VAN BUREN ST.
ENID, OK 73703-8218



CAGE code: 21363

BOBCAT MANUFACTURING CO. (PLANT)

100 PECK HILL ROAD
JOHNSTON, RI 02919



CAGE code: 8H536

BOGNER ENGINEERING CO.

705 N. SPRINGFIELD STREET
P. O. BOX 510
BERRYVILLE, AR 72616



CAGE code: 04BV8

BOLLHOFF & CO. GmbH & CO. KG

ARCHIMDESTRASSE 1-4
BIELEFELD, D-4800 14
GERMANY



CAGE code:

BOLT & NUT CO.

PARK LANE EAST
TIPTON, WEST MIDLANDS, DY4 8RF
UNITED KINGDOM



CAGE code:

BOLT FASTENER STUD/TECHNOLOGY

118 W NUGENT ST
P.O. BOX 2569
LANCASTER, CA 93535

Plant
210 EAST AVENUE
LANCASTER, CA 93539



CAGE code: 31386

BOLTWORKS, INC.

2150 WOODLAND
WARRENDALE, PA 15086-7536



CAGE code: 3LYS4

BOMAR ENGINEERING, INC.

13385 PHILLIPPI AVE.
SYLMAR, CA 91342



CAGE code: 3U494

BOMBSHELL, INC.

9565 PATHWAY ST. #B
SANTEE, CA 92071

509W0

CAGE code: 509W0

BONEAL INC.

6962 HIGHWAY 460
MEANS, KY 40346

Plant
126 INDUSTRIAL PARK RD.
MEANS, KY 40346

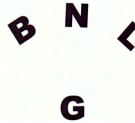

CAGE code: 5X802

BRACELENTE MANUFACTURING CO., INC.

20 WEST CREAMERY ROAD
P.O. BOX 570
TRUMBAUERSVILLE, PA 18970-0570

BMC INC.

CAGE code: 2Y035

BRADY MACHINE, INC.

6125 SKY ROAD
JOSHUA, TX 76058-4048



CAGE code: 1HLW8

BRANCH MACHINE PARTS, INC.

2419 EMPIRE AVE
BURBANK, CA 91504



CAGE code:

BRIARWOOD FASTENERS, INC.

9701 OWENSMOUTH AVE.
UNIT 8
CHATSWORTH, CA 91311-4814

NO LONGER IN BUSINESS

see HEARTLAND PRECISION FASTENER

BFI

CAGE code: 3N278

BRIDEAN MACHINE & TOOL CO., INC.

155 BANGOR STREET
LINDENHURST, NY 11757-3632

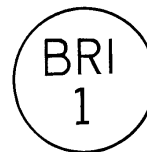

CAGE code: 1S023

BRIDGEVIEW MANUFACTURING CO.

7320 S. FERDINAND AVENUE
BRIDGEVIEW, IL 60455-1111

BVB

CAGE code: 0ALM2

BRIGHT LIGHTS USA, INC.

145 SHREVE AVE.
BARRINGTON, NJ 08007

BL

CAGE code: 0RMF7

BRILES AEROSPACE, INC.

1559 WEST 135TH STREET
GARDENA, CA 90249

BAI

Font: Consolas upper case letters

CAGE code: 73TG7

BRINTCLIFFE TURNER LTD.

CRAMPTONS ROAD
SEVENOAKS, KENT, TN14 5DS
UNITED KINGDOM

BIL **B** **B** **B**

CAGE code:

BRISTOL INDUSTRIES

630 EAST LAMBERT RD.
BREA, CA 92821

B+ CAPITAL B FOLLOWED BY PLUS SIGN
RAISED OR DEPRESSED

BI CAPITAL B FOLLOWED BY CAPITAL I
USED FOR EUROPEAN PARTS ONLY
RAISED OR DEPRESSED

● ● TWO ADJACENT DOTS
RAISED OR DEPRESSED

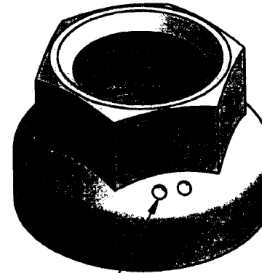

TWO ADJACENT DOTS
RAISED OR DEPRESSED

B - old callout no longer used on
new product

CAGE code: 27238

BRISTOL LOCKNUT CO.

(NUT DIVISION)
32451 N. AVIS DRIVE
MADISON HEIGHTS, MI 48071

//

CAGE code:

BROADSTONE TOOL & DIE, INC.

RT. #1, BOX 986
MCARTHUR, OH 45651

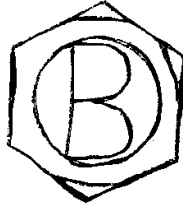

CAGE code: 4Z678

BROADWAY SCREW MACHINE INC.

64 NANCY ST. UNIT B
WEST BABYLON, NY 11704

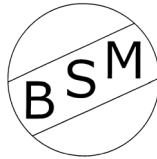

CAGE code: 5CZ56

BROWN PRODUCTION, INC.

804 W MEEKER ST.
KENT, WASHINGTON 98032-5702



CAGE code: 2D069

BRUNNER DRILLING & MFG. CO., INC.

405 ELROY ST.
P.O. BOX 137
ELROY, WI 53929

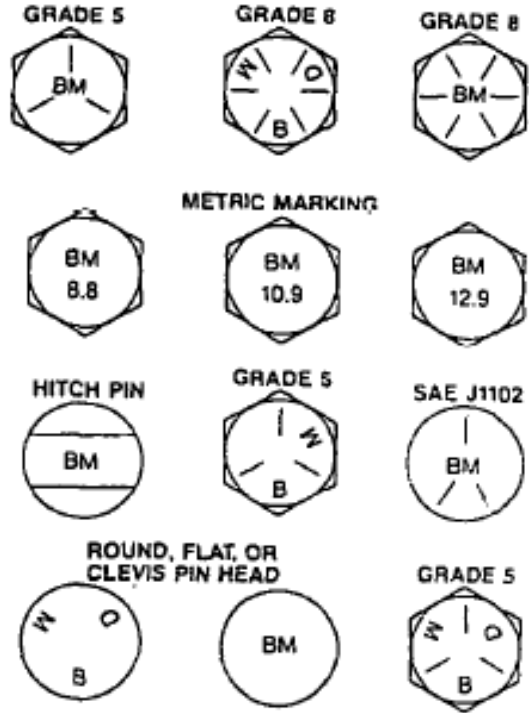

CAGE code: 24407

BRUNNER MANUFACTURING CO.

1025 PARKER DR
MAUSTON , WI 53948 9381

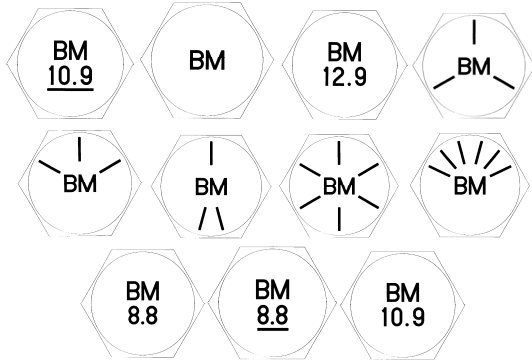

CAGE code: 3B7H2

BRYCO MACHINE, INC.

7800 GRAPHICS DRIVE
TINLEY PARK, IL 60477

BM

CAGE code: 1WCD4

BRYNOLF MANUFACTURING, INC.

412 18TH AVENUE
ROCKFORD, IL 61104

b

CAGE code: 4P7Y2

BUCK EYE FORGE, INC.

11700 HARVARD AVE
CLEVELAND, OH 44105



CAGE code: 71177

BUCKEYE MACHINING, INC.

25020 LAKELAND BLVD.
CLEVELAND, OH 44132



CAGE code: 8X808

BUFFALO PUMPS, INC.

874 OLIVER STREET
NORTH TONAWANDA, NY 14120-3210

BP

CAGE code: 83130

BULA FORGE INC.
2987 E 87TH ST
CLEVELAND, OH 44104-4

BULA

CAGE code:

BULTEN TRADING AB
P.O. BOX 516
734 01 HALLSTAHAMMAR
SWEDEN

Bulten Stainless AB
Ashammar Works
810 25 Ashammar
Sweden

Bulten Stainless AB
Svartå Works
710 11 Svartå
Sweden

BH
BULTEN AB

BUFO
BULTEN AB

SÅ
BULTEN STAINLESS AB

CAGE code: N8286

BURROWERS RESEARCH MACHINING, INC.

43 BRADFORD STREET
P.O. BOX 1130
CONCORD, MA 01742



CAGE code:

BUSAN INDUSTRIAL MACHINERY CO., LTD.

BOLT DIVISION
456-9, NAE-DONG, CHANGWON
KYEONGSANGNAM-DO, KOREA

BM

BIM

CAGE code:

BUTECH PRESSURE SYSTEMS

4928 PITTSBURGH AVE
ERIE, PA 16509

See BER-LOW MFG INC.



CAGE code: 62295

<p>BUTLER, INC. 1600 WEST 166TH STREET GARDENA, CA 90247</p> <p>JB</p> <p>CAGE code: 59053</p>
<p>C & A MACHINE CO. 49 PROGRESS CIRCLE NEWINGTON, CT 06111</p> <p>CA</p> <p>CAGE code: 1HXE7</p>
<p>C & D MACHINE TOLL, INC. 726 COURT STREET SPRINGFIELD, OH 45506</p> <p>C&D MACH</p> <p>CAGE code: 064X3</p>
<p>C & H MFG., INC. 4280 E LOWELL ST ONTARIO, CA 91761-1529</p> <p>30633</p> <p>CAGE code: 30633</p>

<p>C & S ENGINEERING LLC 8807 PIONEER BLVD SUITE K SANTA FE SPRINGS, CA 90670</p>  <p>CAGE code: 4ZH03</p>
<p>C. E. MACHINE CO., INC. 1741 SOUTH LEONINE WICHITA, KS 67209-2813</p> <p>MFR 3L665</p> <p>CAGE code: 3L665</p>
<p>C.E.S. MACHINE PRODUCTS, INC 8880 DOUBLE DIAMOND PKWY RENO, NV 89521-5908</p> <p>CES</p> <p>CAGE code: 1WF66</p>
<p>C.G.I. FASTENERS INC. 18167 HWY 7 N CENTERVILLE, AR 72829</p> <p>01XC</p> <p>CAGE code: 0TDM0</p>

C. J.'S GENERAL MACHINE WORKS

15406 FOREST MIST
SAN ANTONIO, TX 78232-4137



CAGE code: 7W334

C.R.D. MACHINING

366 W. 131ST ST.
LOS ANGELES, CA 90248

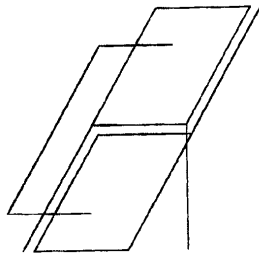

CAGE code: 1LA52

CALABRESE & SONS, INC.

406 BRANDY LANE
P.O. BOX 1667
MECHANICSBURG, PA 17055-2800



CAGE code: 07310

CALIFORNIA SCREW PRODUCTS CORP.

P.O. BOX 228
PARAMOUNT, CA 90723

Plant
14957 GWENCHRIS AVE.
PARAMOUNT, CA 90723-3423

CS

C S

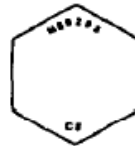

HEX. HEAD



HEX. HEAD

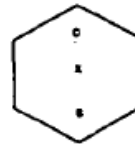

HEX. HEAD

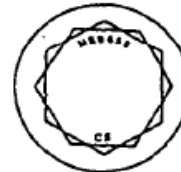

TWELVE POINTS



FLAT HEAD

PAN HEAD

ROUND HEAD

ALL TYPES OF RECESSED

CAGE code: 8Z507

CAMBRIDGE SPECIALTY COMPANY, INC.

588 FOUR ROD RD
BERLIN, CT 06037-2280



CAGE code: 9E232

CAMCAR DIVISION OF TEXTRON INC.

600 18th Ave.
Rockford, IL 61101

Plant
AMSCO PRODUCTS
1818 CHRISTINA ST
ROCKFORD, IL 24382
CAGE code: 01536

Head markings

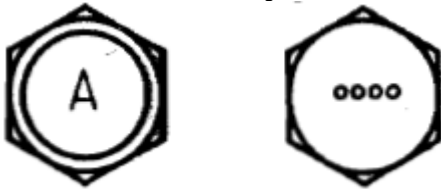

Vendor identification, "A" or four dots raised or depressed located as shown.

Under head markings



Vendor identification, four dots radially located as shown, depressed

(Continued)

(Continued)

CAMCAR DIVISION OF TEXTRON INC.

Plant
DRILLETITE PRODUCTS
1304 KERR DR.
DECORAH, IA 52101
CAGE code: 93907

Head markings



Vendor and customer
Identification for stainless
steel, drilled screws,
raised or depressed

Vendor/Product
Identification, raised or
depressed
Identifies "CAMCAR Self -
Drilling Fastener."



Vendor Identification,
Four in-line dots, raised or
depressed

Under head markings

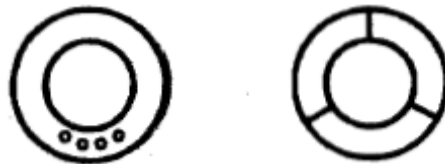

Vendor identification, four radial dots, or three equally spaced radial lines, depressed

(Continued)

(Continued)

CAMCAR DIVISION OF TEXTRON INC.

Plant
RAYCARL PRODUCTS
600 18th Ave.
Rockford, IL 61101
CAGE code: 6P253

Head markings



Vendor Identification, "CAMCAR" or four in-line dots, raised or depressed.

Under head markings

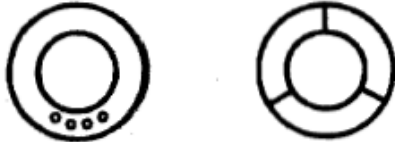

Vendor identification, four radial dots or three equally spaced radial lines, depressed

Plant
ROCKFORD HEADED PRODUCTS
29201 TELEGRAPH RD. SUITE 611
SOUTHFIELD, IL 48034-1331

Head markings



Product Identification, "HP" raised or depressed Product Identification, Four in-line dots, raised or depressed

Under head markings

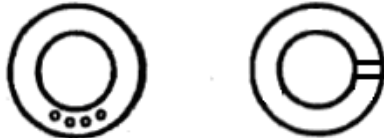

Vendor identification, four radial dots or two parallel lines, raised or depressed

(Continued)

(Continued)

CAMCAR DIVISION OF TEXTRON INC.

Plant
SEMS PRODUCTS
1818 CHRISTINA ST
ROCKFORD, IL 61104
CAGE code: 01536

Head markings

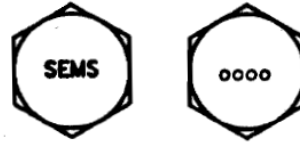

Vendor Identification, "SEMS" or four in-line dots, raised or depressed, located as shown.

Product Trademark Markings

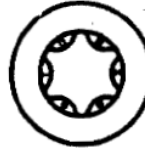

INTERNAL TORX ® RECESS "TORX" and two dots raised or depressed, located as shown



EXTERNAL TORX ® RECESS "TORX" equally spaced on top of washer, raised or depressed.



TORXSTEM ® "TORX" equally spaced on END, raised or depressed.

Plant
SOCKET SCREW PRODUCTS
1302 KERR DRIVE
DECORAH, IA 52101
CAGE code: 0JMM5



Letters "TORX" plus two dots raised or indented on recess countersink; locate as illustrated (Product Trademark)

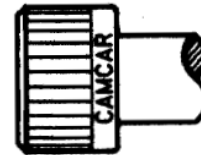

Optional Identification, "CAMCAR", raised or indented as illustrated

Vendor Identification, Four radial dots raised or indented, located as shown

(Continued)

(Continued)

CAMCAR DIVISION OF TEXTRON INC.

Plant
TAPTITE PRODUCTS
826 EAST MADISON ST
BELVIDERE, IL 61008

Head markings



Product Identification, "TTL" raised or depressed



Vendor Identification, "CTY" and three radial lines, raised or depressed

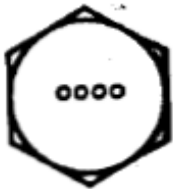

Vendor Identification, Four in-line dots raised or depressed



Vendor Identification, three radial lines and circle, raised or depressed

Under head markings



Vendor identification, four radial dots or three equally spaced radial lines, depressed



(Continued)

(Continued)

CAMCAR DIVISION OF TEXTRON INC.

Plant
TORX PRODUCTS
P.O. Box 607
Rochester, IN 46975
CAGE code: 6N040

Head markings

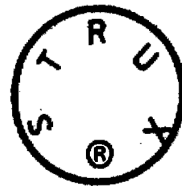

Product Identification, "STRUX ®" equally spaced raised or depressed or four in-line dots, raised or depressed.

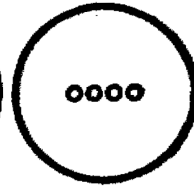

Vendor Identification, superimposed "I" and "M" raised or depressed

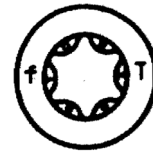

Product Identification "f" and "t" located as shown, raised or depressed



Product Identification, TORX logo located as shown, raised or depressed.

Under head markings



Vendor Identification, four equally spaced radial lines, raised or depressed

Nut Markings



Product Identification, "STRUX ®" raised or depressed, located as shown or four radial dots, raised or depressed.



CAMCAR LLC

500 18TH AVENUE
ROCKFORD, IL 61104

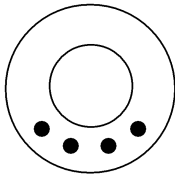

CAMCAR

CAGE code: 4WL75

**CAMCAR SCREW AND MFG CO DIV OF
TEXTRON INC**

29201 TELEGRAPH RD., SUITE 611
SOUTHFIELD, IL 48034 - 7649



PRODUCT IDENTIFICATION,
"HP" RAISED OR DEPRESSED.



PRODUCT IDENTIFICATION,
FOUR IN-LINE DOTS
RAISED OR DEPRESSED.

HEAD
MARKINGS



VENDOR IDENTIFICATION,
FOUR RADIAL DOTS
RAISED OR DEPRESSED.



VENDOR IDENTIFICATION,
TWO PARALLEL LINES
RAISED OR DEPRESSED.

UNDER HEAD
MARKINGS

CAGE code: 6P253

CAMLOC FASTENER CORPORATION

22 SPRING VALLEY ROAD
PARUMUS, NJ 07652
CAGE code: 7G904

CAMLOC GmbH
INDUSTRIESTRASSE 6
D-65779 KELKHEIM, GERMANY
CAGE code: D0680

NO LONGER IN BUSINESS
see ARCONIC FASTENING SYSTEMS &
RINGS



CAMLOC



CAGE code: 7G904, D0680

CAM-TECH INDUSTRIES

95 ESTATES DR W
FAIRPORT, NY 14450-8425



CAGE code: 0GT70

CANADY MANUFACTURING CO. INC.

500 FIFTH STREET
SAN FERNANDO, CA 91340-2225



CAGE code: 00678

CAPRICE ENGINEERING CO., INC.

509 HINDRY AVE.
INGLEWOOD, CA 90301-2017



CAGE code: 52916

CAPY MACHINE SHOP, INC.

114 SPAGNOLI ROAD
MELVILLE, NY 11747



CAGE code: 0BVP9

CARDINAL FASTENER & SPECIALTY CO., INC.

5185 RICHMOND RD
BEDFORD HEIGHTS, OH 44146-1330

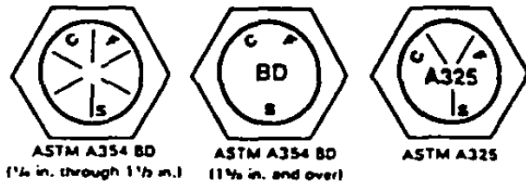

CAGE code: 2Y089

CARDINAL INDUSTRIAL PRODUCTS

3873 WEST OQUENDO
LAS VEGAS, NV 89118-3010



A capital "C" to be applied to all standard ASME/ASTM bolting material.

MULTI-C

The word "MULTI" followed by a capital "C" to be applied to all ASME bolts manufactured to Nuclear Standards Associates or Cardinal Industrial Products, Inc. Standards.

CAGE code: 57454

CARDINAL MACHINING SERVICES LLC.

8807 PIONEER BLVD. SUITE K
SANTA FE SPRINGS, CA 90670



CAGE code: 6BDQ3

CARR CO.

(THE UNITED CARR DIV OF TRW)
31 AMES ST.
CAMBRIDGE, MA 02142



CAGE code: 78947

CATALINA INSTRUMENT CORPORATION
44 SOUTH MALL
PLAINVIEW, NY 11803-4208

CI

CAGE code: 30225

CAVALIER BOLT & NUT, INC
7420 WRIGHT RD
JERSEY VILLAGE, TX 77041



BOLT

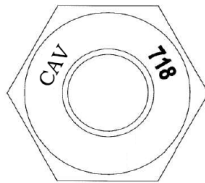

NUT

CAGE code: 3Y787

CBS FASTENERS INC.
1345 BRASHER STREET
ANAHEIM, CA 92807-2046

CBS
CbS

CAGE code: 0F620

CCB INDUSTRIES, INC.
3200 STUART DRIVE
P.O. BOX 1158
FT. WORTH, TX 76101

CCB

CAGE code: 60763

CCF ENTERPRISES INC.
2449 N.W. DALLAS STREET
GRAND PRARIE, TX 75050-4971

CCF

CAGE code: 08QQ4

CDS MACHINE INC.
116 E. AIRPORT RD.
HASKELL, OK 74436

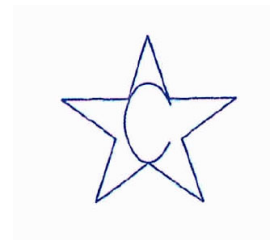

Star with letter "C"

Text Size
Star = .100
C = 04
GOTHIC FONT

CAGE code: 517Z8

CEI INC.
DBA COMMAND ENTERPRISES
700 NORTH DELSEA DR
PITMAN, NJ 08071-1244

L-S-A

CAGE code: 6U479

CELTECH ENTERPRISE

9774 CRESENT CTR DR
SUITE 506
RANCHO CUCAMONGA, CA 91730-5745



CAGE code: 0EFF7

CEN TEX DEFENSE INDUSTRIES

PO BOX 1863
FREDERICKSBURG, TX 78625

Plant:
738 MUSTANG STREET, SUITE F
FREDERICKSBURG, TX 78624

CTeXD

CAGE code: 0CYP7

CENTENNIAL BOLT, INC.

4930 FOX STREET
SUITE A
DENVER, CO 80216

Plant:
GEM-YEAR INDUSTRIAL CO., LTD.
NO. 8 GEM-YEAR ROAD
ECONOMIC DEVELOPMENT
ZONEJIASHAN
ZHEJIANG, PEOPLE'S REPUBLIC
OF CHINA

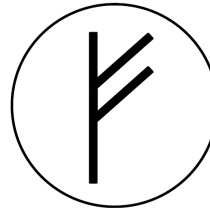

CAGE code:

CENTERLINE TOOL & ENGINEERING, INC.

3107 29TH AVENUE E
BRADENTON, FL 34208-7420



Capital "C" and Capital "L" combined.

CAGE code: 0B5B0

CENTRAL OZARK MACHINE, INC.

HWY 19 SOUTH & HH
P. O. BOX 347
ALTON, MO 65606-0347



CAGE code: 64896

CENTURY METAL PARTS CORP.

230 SOUTH FEHRWAY
BAY SHORE, NY 11706-1208



CAGE code: 30396

AAX

CENTRAL SCREW PRODUCTS

6425 EAST HILDALE
DETROIT, MI 48234



CAGE code: 1YCR3

CENTRIX, INC

1022 WEST VALLEY HWY
KENT, WA 98032

C 20-1

CAGE code: 8CYQ1

CEREBRUS CORPORATION
71 OLD CAMPLAIN ROAD
HILLSBOROUGH, NJ 08844



CAGE code: 506M3

CERNY MFG. CO.
4057 WEST 147TH STREET
LAWNDALE, CA 60260

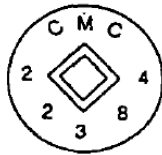

CMC ◊ 22384.

CAGE code: 22384

CETIN CIVATA SANAYI VE TICARET A.S.
FABRIKALAR CAD No 17
MURATBEY MERKEZ MAH
CATALCA, INSTANBUL, TURKEY 34540

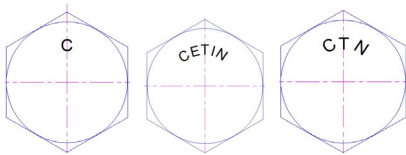

CAGE code:

CHAMPION COMMERCIAL INDUSTRIES, INC

CHAMPION RIVET DIVISION
P.O. BOX 398
5137 INDIANAPOLIS BLVD
EAST CHICAGO, IN 46312-0398



CAGE code: 4B951

CHAMPION FASTENERS, INC.
707 SMITHVILLE RD
LUMBERTON, NJ 08048-5302



CAGE code: 0NXPO

CHANCE, A.B. COMPANY
2201 LAKEVIEW RD
MEXICO, MO 65265-1360



CAGE code: 02TP8

CHANDLER PRODUCTS, INC.
1491 CHARDON RD
CLEVELAND, OH 44117-1598

Division of ELGIN FASTENER GROUP LLC.



CAGE code: 83386

CHATHAM PRECISION, INC.

COMMERCE ST.
P.O. BOX 510
HINESBURG, VT 05461

4N133

CAGE code: 4N133

CHEMIQUIP PRODUCTS COMPANY

56 2nd AVENUE
BROOKLYN, NY 11215



CAGE CODE: 99752

CHEREK MACHINE & TOOL CO., INC.

835 SHERMAN AVENUE
HAMDEN, CT 06514-1149

CHEREK

CAGE code: 0YWD4

**CHEROKEE TOOL & ENGINEERING CO.,
INC.**

P.O. BOX 227
CANTON, GA 30114



CAGE code: 30662

**CHIANG SHIN FASTENERS INDUSTRIES,
LTD**

NO. 111 WANLI ROAD
GANGSHAN TOWNSHIP, KAOHSIUNG
COUNTRY 82050, TAIWAN (R.O.C)



(see Stelfast Inc.)

CAGE code: SFV96

CHICAGO FASTENER MANUFACTURING

10902 WALNUT LANE
MOKENA, IL 60448-8165

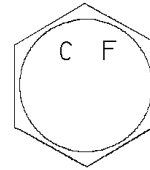

CAGE code: 05TL5

CHICAGO HARDWARE & FIXTURE CO.

9100 PARK LANE
FRANKLIN PARK, IL 60131-3054

CHF



CAGE code: 71747

CHICAGO NUT & BOLT INC.

150 COVINGTON DRIVE
BLOOMINGDALE, IL 60108

CNB

CAGE code: 1C4D2

<p>CHIEF MFG. 423B WEST FORK DRIVE ARLINGTON, TX 76012-3450</p>  <p>CAGE code: 00WU0</p>
<p>CHOICE PRECISION MACHINE, INC. 4280 COMMERCE DRIVE WHITEHALL, PA 18052</p> <p>CPM</p> <p>CAGE code: 1WAA0</p>
<p>CHRIS MACHINE CO. 110 DOYLE ST. DOYLESTOWN, PA 18901-1370</p>  <p>CAGE code: 2T317</p>
<p>CHU HUA INDUSTRIAL CO., LTD. 800 FU SHING RD. LU CHU, KAOHSING, TAIWAN, 821 R.O.C.</p>  <p>UH</p> <p>CAGE code:</p>

<p>CHUN YU WORKS & CO., LTD. 1 CIASHING KANGSHAN, TAIWAN</p>  <p>CAGE code:</p>
<p>CINCH MANUFACTURING 2610 S YALE ST SANTA ANA, CA 92704</p>  <p>CAGE code:</p>
<p>CLEVELAND HARDWARE & FORGING DBA GREEN BAY DROP FORGE 1341 S. STATE ST P.O. BOX 11797 GREEN BAY, WI 54307-1797</p>  <p>Circle with center dot</p> <p>CAGE code: 08277</p>
<p>CLICK BOND, INC. 2151 LOCKHEED WAY CARSON CITY, NV 89706-0713</p> <p>CB</p> <p>CAGE code: 66530</p>

CLYDE FASTENERS LIMITED
5 HAWBANK RD,
EAST KILBRIDE, GLASGOW, SCOTLAND
G74 5ET

CFL

CAGE code:

COAE BOLTS WORKS CO., LTD
NO. 47 CHINAN ROAD, TASHE HSIANG
KOAHSIUNG HSIEN, TAIWAN

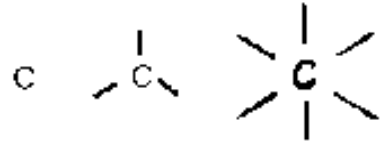
A325

CAGE code:

CM MANUFACTURING, INC.
6333 BUTLER CREEK ROAD
MISSOULA, MT 59808-8861

CM

CAGE code: 6Z056

COAST INDUSTRIAL SUPPLY CO., INC.
SUB OF SPANDCO INDUSTRIES INC.
15959 PIUMA AVENUE
CERRITOS, CA 90701-1526

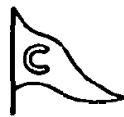
 On head of silicon bronze and aluminum hex head cap screws

 On head of stainless steel, monel, brass, naval bronze, chrome alloy, hex head cap screws, and the end of alloy steel studs.

CAGE code: 9U032

CMTECHTOOLS, LLC
2125 VININGS CIRCLE, APT. 12
WELLINGTON, FL 334144

CMT

CAGE code: 7J7C4

CODLING TOOL & MFG. INC.
665 NE 42ND STREET
FORT LAUDERDALE, FL 33334

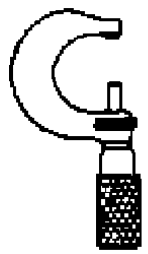

CAGE code: 0P3X2

CNC MACHINING INC.
109 PANE ROAD
NEWINGTON CT 06111-1552

C

CAGE code: 2Y832

COLD HEADING CO., THE
21777 HOOVER RD.
WARREN, MI 48089-2544



CAGE code: 89657

COLOC MANUFACTURING DIVISION
INGRAM INDUSTRIES, INC.
P.O. BOX 249
CANTON, TX 75103

Plant
465 VZ CR 2516
CANTON, TX 75103



CAGE code: 0M6Y0

COLSAX LLC
33 WEST STREET
PO BOX 246
MONTELLO, WI 53949

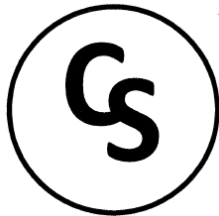

CAGE code: 7TMX6

COLTEC INDUSTRIES, INC.
DBA FAIRBANKS MORSE ENGINE
701 WHITE AVENUE
BELOIT, WI 53511



CAGE code: 82796

COMET MFG. CO., INC.
315 JOHN DOWNEY DRIVE
NEW BRITIAN, CT 06051

61062

CAGE code: 61062

COMMAND ENTERPRISES
700 NORTH DELSEA DR.
PITMAN, NJ 08071
see CEI INC.



CAGE code:

COMPONENT PRODUCTS CORPORATION
11623 CYRUS WAY
MUKILTEO, WA 98275

6F140

CAGE code: 6F140

COMPUTA-BASE MACHINING, INC.

411 NORTH GROVE ST
P.O. BOX 340
BERLIN, NJ 08009-9704

CBM

CAGE code: 0A396

CONNECTICUT AIRCRAFT PRODUCTS

246 SHAKER ROAD
ENFIELD, CT 06082-2366

CA

CAGE code: 0KA73

**CONTINENTAL MACHINE PRODUCTS,
INC.**

11 WALLEY STREET
EAST BOSTON, MA 02128

CP

CAGE code: 0T1E0

CONTINENTAL TOOL & MANUFACTURING

15941 W. 108th STREET
LENEXA, KS 66219

CTM

CAGE code: 63003

CONTRACTING CNC MACHINING

8360 CURRENCY DR.
UNIT #7
RIVIERA BEACH, FL 33404

CCM

CAGE code: 64M67

CONQUEST MACHINE, INC.

3655 RESEARCH DR.
GENESIS A STE 106
LAS CURCES, NM 88003-1239

CMI

CAGE code: 0PNX2

CO-OP SCREW MANUFACTURING CORP.

60 SINDLE AVE.
LITTLE FALLS, NJ 07424-1649

C

CAGE code: 1FZ52

COOPER POWER SYSTEMS INC

MCGRAW EDISON POWER SYSTEMS
NORTH BURSON STREET
EAST STROUDSBURG, PA 18301

M

CAGE code: 88424

COPA TOOL, LLC

465 N. MILL ST.
SOUTH LYON, MI



CAGE code: 0H6Z1

COPELAND MFG. CORP.

(JAMES DIVISION)
11222 E. PINE ST.
TULSA, OK 74116-1613



CAGE code: 0CM67

COPPER STATE BOLT & NUT CO.

3602 N 35TH AVE.
3637 N 34TH AVE.
PHOENIX, AZ 85017-4408

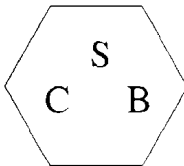

CAGE code: 0Z0Y2

CORPUS CHRISTI GASKET & FASTENER LTD.

341 WEST CHESTER RD.
P.O. BOX 4074
CORPUS CHRISTI, TX 78408



CAGE code: 008R2

CREATIVE PRECISION INC.

DBA CREATIVE PRECISION WEST
2640 E. ROSE GARDEN LANE SUITE 6
PHOENIX, AZ 85050-4612

Plant
1501 BLUEBALL AVENUE
LINWOOD, PA 19061
CAGE code: 0F3N2



CAGE code: 1K0E5

CRESCENT MANUFACTURING CO.

P.O. BOX 1350
BUILINGTON, CT 06013-0350

Plant
700 GEORGE WASHINGTON TPKE
BUILINGTON, CT 06013-0350



CAGE code: 63020

CRS PRECISION CORP.
640 WEST MERRICK ROAD
VALLEY STREAM, NY 11580-0482



CAGE code: 07QQ6

CRUM MFG.
1265 WATERVILLE-MONCLOVA RD.
WATERVILLE, OH 43566



CAGE code: 57ZX3

CRYSTAL METAL PRODUCTS COMPANY, INC.
2700 E. CASTOR AVENUE
PHILADELPHIA, PA 191345



CAGE code: 0BPW8

CSM FASTENER PRODUCTS
1133 BRTN MAWR AVE.
BENSENVILLE, IL 60106

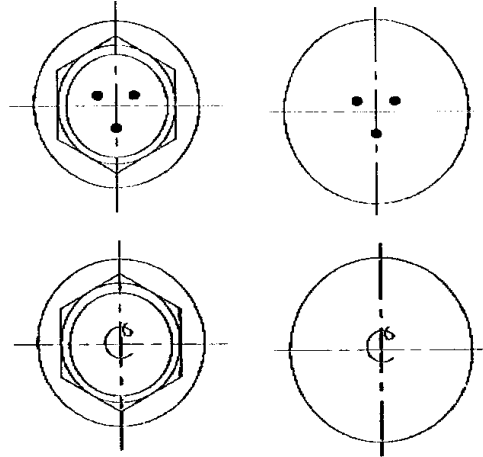

CAGE code: 1CJW4

CUMMINS AEROSPACE
DBA YEAGER MANUFACTURING CORP
2200 E. ORANGETHORPE AVE.
ANAHEIM, CA 92806



CAGE code: 31788

CURTIS PRESTON ENTERPRISES INC.
DBA ATLAS SPECIALTY PRODUCTS
2299 E WINSTON RD
ANAHEIM, CA 92806-5538



CAGE code: 0TP31

CUTTING EDGE ENTERPRISE, LLC

2465 POLE LINE RD.
DECORAH, IOWA 52101

Plant
2509 172ND AVE.
DECORAH, IOWA 52101

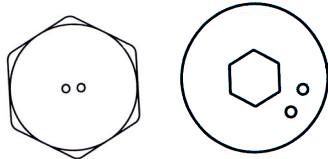

CAGE code: 52101

CUTTING EDGE MACHINING INC.

NEVADA DIV
1625 LINDA WAY
SPARKS, NV 89431

See WESTERN SCREW MACHINE
PRODUCTS, INC.



CAGE code: 0ZV72

**CUTTING EDGE MACHINING SOLUTIONS,
INC.**

P.O. BOX 248
75 BASIN RUN ROAD
DRIFTING, PA 16834



CAGE code: 3EQ16

CWR MANUFACTURING CO

DIVISION OF A.J. MUPHY CO., INC.
P.O. BOX 2669
SYRACUSE, NY 13220

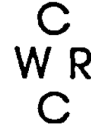

CAGE code:

D & D MACHINERY AND SALES

2420 W. R. LARSON ROAD
SAN ANTONIO, TX 78261-2200

1Y128

CAGE code: 1Y128

D & D MANUFACTURING

26199 JEFFERSON AVE.
MORRIETA, CA 92562



CAGE code: NONE 1/

D & D TOOL COMPANY, INC.

LEWIS STREET & MAPLE AVENUE
EATONTOWN, NJ 07724

D & D

CAGE code: 30077

MIL-HDBK-57J (GS7)
APPENDIX A

D & R MACHINE COMPANY
2310 BIG OAK ROAD
LANGHORNE, PA 19047-1910

4T853

CAGE code: 4T853

D. C. MACHINING INC.
1900 9TH AVE., SW
WATERTOWN, SD 57201

DC

CAGE code: 0AUC7

DDM SUPPLY LLC
2518 STATE ROUTE 12
CHENANGO FORKS, NY 13746

D

CAGE code: 7RY35

D.S.O. PLASTICS, INC.
1220 ROCK ST.
ROCKFORD, IL 61101

Z

CAGE code:

DABS M&A, LLC
22 42nd ST NW, STE B
AUBURN, WA, 98001

DABS

CAGE code: 7TW13

DACK INDUSTRIES, IN.
P.O. BOX 427
FARMINGTON , CT 06034 - 0427

d

CAGE code: 0CZ42

DANIEL CO., EDWARD W.
11700 HARVARD AVENUE
CLEVELAND, OH 441053



CAGE code: 73634

DAN-LOC BOLT & GASKET INC.
FORMALLY
DANIEL INDUSTRIES, INC.
Bolt & Gasket Division
P.O. BOX 292
HOUSTON, TX 77001-0292

Plant
725 North Drennan
Houston, TX 77003

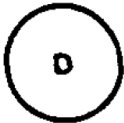

STUDS



HEX NUTS

CAGE code:

DARCO PRODUCTS
8406 WASHINGTON PL NE
ALBUQUERQUE, NM 87113-1671

D P

CAGE code: 1DL79

DAVE ALLEN ENTERPRISES
10631 BLOOMFIELD AVENUE
UNIT 15
LOS ALAMITOS, CA 90720

DAE

CAGE code: 1NWX4

DAVIES PRECISION MACHINING, INC.
2400 COLEBROOK RD.
LEBANON, PA 17042-9562

DPM

CAGE code: 7V760

DAVIS AIRCRAFT PRODUCT CO., INC.
1150 WALNUT AVENUE
BOHEMIA, NY 11716-6216



DAP

CAGE code: 98313

**DAYMAK SU DEPOSU IMALAT MAKINA
INSAAT TAAHHUT TURIZM GIDA VE DIS
TIC. LTD. STI.**

IVEDIK OSB 1468.CAD, 163/71
YENIMAHALLE/ANKARA, TURKEY



CAGE code: TD847

DECKER MANUFACTURING CORP

703 NORTH CLARK STREET
P.O. BOX 410
ALBION, MI 49224-1455

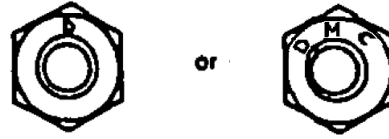

HEX WHEEL NUTS
(DEPRESSED "D" or "MDC")



AMERICAN STANDARD
SQUARE, HEX, AND ROUND WELD NUT
(SMALL RAISED DOR ON CHAMFER)

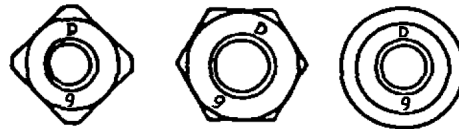

METRIC
SQUARE, HEX, AND ROUND WELD NUTS
(DEPRESSED LETTER "D" AND CLASS NO.)



A-563
STRUCTURAL NUTS
(DEPRESSED "D" OR "DMC")

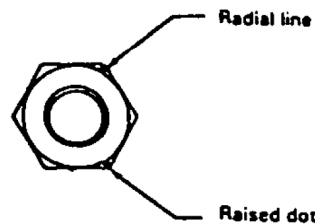

GRADE 5
NEX NUTS
(ONE RAISED RADIAL LIVE 120°
COUNTERCLOCKWISE FROM ONE
RAISED DOT ON CHAMFER)

CAGE code: 12876

DEERE & CO.

JOHN DEERE PLACE
MOLINE, IL 61265

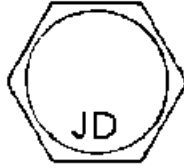

CAGE code: 75160

DEFIANCE STAMPING COMPANY, THE

P.O. BOX 506
DEFIANCE, OHIO 43512-2743

PLANT
1090 PERRY ST
DEFIANCE, OHIO 43512-2743

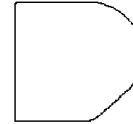

CAGE code: 6B357

DEFENSE AEROSPACE

*MFG OF DEFENSE AEROSPACE
THREADED MACHINE PARTS*
10841 NOEL ST. #104
LOS ALAMITOS, CA 90720-2527



CAGE code: 1W4A6

DEHOUSSE (USINES)

64007 PAU
FRANCE



CAGE code: BP714

DELL MFG. CO., INC.

4 RIGHT LANE
FARMINGTON, CT 06032-3195

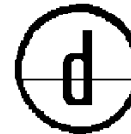

CAGE code: 5A628

DEFENSE QUALITY MFG.

40 SACCO RD.
ROYERSFORD, PA 19468-1030



CAGE code: 0B6M7

DELT INDUSTRIES, INC.

AEROSPACE PRODUCTS DIVISION
90 WEST EASY STREET, STE 2
P.O. BOX 940067
SIMI VALLEY, CA 93065-6206



CAGE code: 064T2

DELTA MACHINE & TOOL CO., INC.
PARKMOUNT ROAD
P.O. BOX 351
GLEN RIDDLE, PA 19037



CAGE code:

DEL-VAL FASTENER MANUFACTURING
P.O. BOX 2901
21-D INDUSTRIAL DRIVE
WARMINSTER, PA 18974



CAGE code: 1EE10

DEMAT
BD DU GRAND CASTAING ZI
BD DU GRD CASTING
ROQUES, FRANCE 31120

NO LONGER IN BUSINESS

see MECAERO PRODUCTS



CAGE code: F7411

DEPENDABLE MACHINE CO., INC.
1846 E 30TH ST
INDIANAPOLIS, IN 46218-2607



CAGE code: 14554

DERBYSHIRE MACHINE & TOOL CO.
DBA DERBYSHIRE MARINE PRODUCTS
5100 BELFIELD AVENUE
PHILADELPHIA, PA 19144-1788



CAGE code: 71905

DETROIT HEADING CO.
6421 LYNCH RD.
DETROIT, MI 48234-4140



CAGE code: 0TUA2

DEUTSCH FASTENER CORPORATION
3969 PARAMOUNT BLVD.
LAKEWOOD, CA 90712-4193

NO LONGER IN BUSINESS

see HUCK INTERNATIONAL INC.



CAGE code: 97928

DFCI SOLUTIONS, INC.
425 UNION BLVD.
WEST ISLIP, NY 11795-3183



CAGE code: 72794

DHL ENTERPRISES
1260 E. WOODLAND AVENUE #46
P. O. BOX 295
MORTON, PA 19070



CAGE code: 0UGD5

DIAL SUPPLY AND MFG., INC.
1315 FM 1187
#106
MANSFIELD, TX 76063



CAGE code: 9N473

DIESEL PARTS COMPANY OF CALIFORNIA
1900 EAST 12TH STREET
OAKLAND, CA 94606-4821



CAGE code: 24378

DIHARD COMPANY
3161 MAJOR STREET
FORT WORTH, TX 76112 - 7020



CAGE code: 0F1U4

DILLON AERO, INC.
8009 E. DILLONS WAY
SCOTTSDALE, AZ 85260



CAGE code: 1PN61

DISC-LOCK INTERNATIONAL
1924 S PACIFIC COAST HWY SUITE F
REDONDO BEACH , CA 90277



CAGE code: 72731

DIVERSIFIED FASTENING SYSTEMS, INC.
P.O.BOX 339
CHARLES CITY, IA 50616

Plant
501 RICHINGS STREET
CHARLES CITY, IA 50616



CAGE CODE: 0S311

DIXON MACHINE & TOOL
DBA DIXON MACH AND FABRICATION
6807 CHAPMAN HWY.
KNOXVILLE, TN 37920-6560

see TROY D. RAY

DMT

CAGE code: 1DEP3

DO MANUFACTURING CORP.
P.O. BOX 2382
114 BROOKLYN ST
ROCKVILLE, CT 06066

PLANT
114 BROOKLYN ST.
ROCKVILLE, CT 06066



CAGE code: 1H312

DO-ALL PRECISION, INC.
9 UNION AVENUE
MOUNT VERNON, NY 10550



CAGE code:

DOMESTIC FASTENER & FORGE, INC.
P.O. BOX 14642
LENEXA, KS 66285

Plant
15850 W. 108TH STREET
LENEXA, KS 66219

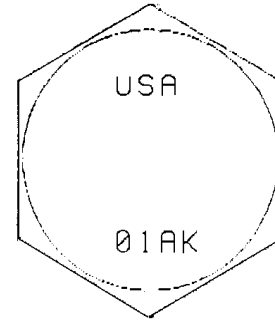

CAGE code: 09ML9

DOMESTIC FORGING, INC.
P.O. BOX 693
NEW HAVEN, MI 48048



CAGE code:

DONSON MACHINE
ALSIP MACHING GROUP
12416 S. KEDVALE AVENUE
ALSIP, IL 60803-1819

DMC

CAGE code: 0BHD5

DOUBLECO INCORPORATED
DBA R & D FASTENERS
9444 9TH STREET
RANCHO CUCAMONGA, CA 91730



CAGE code: 1UKP3

DOUGLASS TOOL & ENGINEERING CO., INC.
304 EAST DYER ROAD
SANTA ANA, CA 92707

DTE
Marking to be indented

CAGE code:

DRESSER INDUSTRIES, INC.
DRESSER PUMP DIVISION
142 CLINTON ROAD
FAIRFIELD, NJ 07004



CAGE code: 0LNV2

D'SAMIC
1261 HOBLITT AVE # 206
CLOVIE, CA 93612-2811



CAGE code:

DTF MANUFACTURING, INC.
DIV OF FEDERAL SCREW AND SUPPLY CO
P. O. BOX 329
146 ALBANY AVE.
LINDENHURST, NY 11757



Standard: DTF
Large Dia: **DTF**
DTF
Micro Dia: **d**

CAGE code: 0H802

DUFFY ELECTRONICS & MFG. CO.

50 BARNES PARK RD
WALLINGFORD, CT 06492



CAGE code:

DUNCAN ELECTRONICS & MFG. CO.

701 SEVENTH AVE.
BELMAR, NJ 07719



CAGE code:

DUNHAM PRODUCTS, INC.

7400 NORTHFIELD RD.
WALTON HILLS, OH 44146



CAGE code: 1B4S0

DUPONT, G.B. CO., INC.

see G.B. DUPONT CO., INC
500 WEST LONG LAKE ROAD
TROY, MI 48098-4540

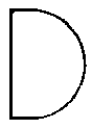

CAGE code: 1DWW1

DUSEVOIR METAL PRODUCTS, INC.

1751 S TELEGRAPH RD
P.O. BOX 2158
DEARBORN, MI 41823



CAGE code: 97233

DUVE GmbH & CO. KG

P.O. BOX 1240
NEUENRADE, GERMANY D-5982

- D** - All hexagon head screws and bolts made of high tensile steel grade 8.8 up to 12.8, and sealing fasteners made of case-hardened carbon steel
- DX** - Hexagon head sealing fasteners made of stainless steel
- DUVEX** - Hexagon head screws and bolts made of stainless steel (A2 + A4)
- DUVE** - DUVE DRIL-KWICK Self-Drilling Fastener (Screws)



CAGE code:

DYNACAST

INDUSTRIAL FASTENERS DIVISION
1401 FRONT STREET
YORKTOWN HEIGHTS, NY 10598



CAGE code:

DYNAMIC ENGINEERING

720 11TH AVE., S.E.
P.O. BOX 697
WATERTOWN, SD 57201-0697



CAGE code: 9U252

DYSON CORP THE

formerly (JOS. DYSON & SONS, INC.)
53 FREEDOM RD
PLAINSVILLE, OH 44077-1232



CAGE code: 22132

DZUS FASTENER CO., INC.

see DFCI SOLUTIONS, INC.
425 UNION BLVD
WEST ISLIP, NY 11795



CAGE code: 3L478
cancelled- replaced by 72794

E. KOZAK PRECISION PRODUCTS CO.

45 WOODLAND AVE.
ROCKAWAY, NJ 07866



CAGE code: ICP43

E.L.R. MACHINE AND TOOL

48 A VINCENT CIRCLE
IVYLAND, PA 18974



CAGE code:

EAGAN MACHINE CORP.

135 CENTER STREET
BRISTOL, CT 06010



CAGE code:

EAGLE PICHER INDUSTRIES

(PRECISION PRODUCTS PLANT)
1927 W 4TH ST
P.O. BOX 1444
JOPLIN, MO 64801-3



CAGE code: 9L734

**EAGLEHEAD MANUFACTURING
COMPANY**

DBA DEJAK MACHINE TOOL COMPANY
DIV DEJAK DRILLING
23555 EUCLID AVE
EUCLID, OH 44117-1703

Alphanumeric Designation

01NU

CAGE code: 1GVE5

EAST BAY MANUFACTURERS INC.

P.O. BOX 436
BRISTOL, RI 02809

Plant
400 FRANKLIN STREET
BRISTOL, RI 02809

E
B
M

CAGE code: 5BE51

EAST COAST METALS INC.

171 RUTH ROAD
HARLEYSVILLE, PA 19438

E

CAGE code: 4W058

EASTERN SCREW CO., INC.

15 AMFLEX DRIVE
CRANSTON, RI 02921-2028

Plant
71 MILL STREET JOHNSON,
CRANSTON, RI 02921-2028

E

CAGE code: 2L684

EASTWOOD MFG., CO.

P.O. BOX 231102
6825 BREEN RD
HOUSTON, TX 77086-3719

Plant
52 Lawndale
Houston, TX 77023

E M

CAGE code: 77903

EATON AEROQUIP CORPORATION

AEROSPACE DIVISION
300 S. EAST AVE.
JACKSON, MICHIGAN 49203-1972

A

CAGE code: 00624

EBC INDUSTRIES

(FORMERLY ERIE BOLT CORP.)
1325 LIBERTY STREET
ERIE, PA 16502-1641

ERIE E

CAGE code: 5G920

EBERHARD BRUNINGHAUS
POSTFAUCH 12 06 1M DUDA2
NEUENRADE, FEDERAL REPUBLIC OF
GERMANY D 5982



EBM

CAGE code:

ECENARRO S. COOP. LTDA.
c/ AMILLAGA, 15.
BERGARA - GUIP'UZOCA,
SPAIN 20500



ESC

CAGE code:

EDS ORDNANCE
644 C ANCHORS ST.
FT. WALTON BEACH, FL 32548



CAGE code: 1CA31

ELASTIC STOP NUT
DIVISION OF HARVARD INDUSTRIES, INC.

See MACLEAN-ESNA

Plant
2330 Vauxhall Road
Union, NJ 07083

2nd Plant
3200 Country Club Road
P.O. Box 988
Pocahontas, AR 72455

E, EN, or ESNA Red nylon insert in locknuts

Red nylon insert in locknuts identifies Esna as
manufacturer

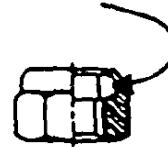

CAGE code:

ELCO INDUSTRIES, INC.
1111 SAMUELSON RD
ROCKFORD, IL 61101

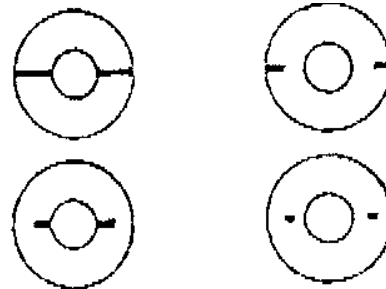

Underside of screw head



CAGE code: 83486

**ELECTRO-FREETO MANUFACTURING
COMPANY**

37 POPE ROAD
HOLLISTON, MA 01746-2218

JF

CAGE code: 17401

ELEIT TECHNOLOGY, INC.

201 TRIANA BLVD.
HUNTSVILLE, AL 38505

Plant
31291 Highway 35
Woodville, AL 35776

ETI

CAGE code: 1DET1

ELGIN FASTENER GROUP LLC

4 SOUTH PARK AVE.
SUITE 203, BOX 5
BATESVILLE, IN 47006



Plants (see listing separately)

CHANDLER PRODUCTS

1491 CHARDON RD.
CLEVELAND, OH 44117
CAGE code: 83386

QUALITY BOLT & SCREW

10147 BRECKSVILLE RD.
BRECKSVILLE, OH 44141
CAGE code: 0BCN3

TELEFAST INDUSTRIES

777 W. BAGLEY RD.
BEREA, OH 44017
CAGE code: 3CW33

CAGE code: SEE ABOVE

ELITE FASTENERS

6400 DALE STREET
BUENA PARK, CA 90621

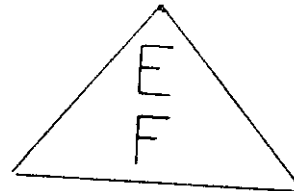

CAGE code: 0T3D2

ELLIS PRECISION INDUSTRIES

DBA E P IND.
3133 RAMONA DR
FORT WORTH, TX 76116-5122

e



CAGE code: 9Z199

EMERALD VALLEY MFG

3825 W. 11TH AVE
SUITE B
EUGENE, OR 97402

DTE

CAGE code: 4Y352

EMHART CORP.

PARKER-KALON DIVISION
395 ROBERTS ROAD
CAMPBELLSVILLE, KY 42718



"TRIANGLE" MARKING

GRIPCO FASTENER DIVISION

111 EAST BROAD STREET
SOUTH WHITLEY, IN 46787



GH raised or indented on flange or bearing surface



GH raised on head, both inch and metric series e



GH raised or indented on flange or bearing surface

CAGE code: 73020

EMP MANUFACTURING CO.
40935 PRODUCTION DR
HARRISON TOWNSHIP, MI 48045-1351

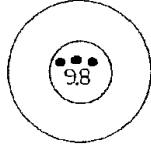

CAGE code: 4G973

**ENGEL MANUFACTURING COMPANY,
INC., THE**

304 W. EWING AVENUE
SOUTH BEND, IN 46613-2108



CAGE code: 0XYS0

EMPIRE PRECISION MACHINING

108 W. HOLLOWAY DR.
HURST, TX 76053-6807

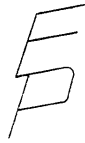

CAGE code: 5V179

ENGINEERED BOLTING PRODUCTS, INC.

P.O. BOX 7067
301 MONTGOMERY ST
SHREVEPORT, LA 71137

Plant
301 Montgomery St.
Shreveport. LA 71107

EBP

CAGE code: 0K4X1

ENDURALOCK, LLC

14847 WEST 95TH STREET
LENEXA, KS 66215



CAGE: 7QJV4

ENGINEERING MATERIALS CO., INC.
FASTENER MANUFACTURING DIVISION
2055 WEST COWLES STREET
LONG BEACH, CA 90813-1087

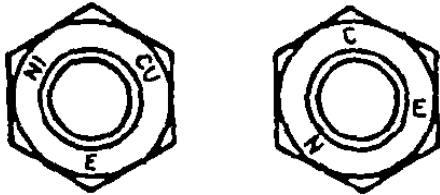

Mfr. Symbol/Logo embossed or intent marked. Letter "E" as shown on nut crown spaced 120 degrees from material symbol marking.

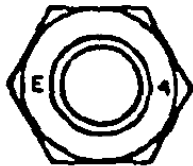

Mfr. Symbol/Logo letter "E" as shown, opposite material symbol marking code on nut crown at corners.

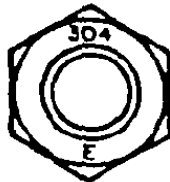

Mfr. Symbol/Logo letter "E", as shown on nut crown, 180 degrees opposite material symbol marking.



Mfr. Symbol/Logo letter "E" marked opposite material symbol code marking on nut crown at one corner location.

CAGE code: 19968
(Continued)

(Continued)

ENGINEERING MATERIALS CO., INC.



Mfr. Symbol/Logo letter "E" marked opposite material symbol code marking on nut crown at one corner location.



Mfr. Symbol/Logo letter "E" marked on crown, 180 degrees opposite thread designation letter.



Mfr. Symbol/Logo letter "E" indent marked above material symbol.



Mfr. Symbol/Logo letter "E" as shown marked above material symbol marking on stud or rod end.

CAGE code: 19968

**ENGLE MANUFACTURING COMPANY,
INC., THE**

304 W. ERVING AVE.
SOUTH BEND, IN 46613

**EM
F593
T**

CAGE code: 0XYS0

ENOMOTO INDUSTRIES CO., LTD.

3-26 TAKASAGO, TAKAISHI-SHI,
OSAKA, 592
JAPAN



CAGE code: S0132

ENVISION TECH, INC.

4404 S. 40TH TERRACE
ST. JOSEPH, MO 64503

ETI

CAGE code: 056X3

ERICO FASTENING SYSTEMS

301 NEW ALBANY ROAD
MOORESTOWN, NJ 08057



CAGE code: 84483

ERIE BOLT CORP.

1325 LIBERTY STREET
ERIE, PA 16502

see EBC INDUSTRIES

ERIE E

CAGE code: 5G920

ESCO PRECISION, INC.

71 OLD CAMPLAIN RD.
HILLSBOROUGH, NJ 08844

EPI

CAGE code: 1YRR0

ESMET, INC.

DBA ELECTROLINE TTUFLOC

1406 5TH ST., S.W.
CANTON, OH 44702-2062
CAGE code: 79931

SUB OF UNIMET CORP

1406 5TH ST., S.W.
CANTON, OH 44702-2062
CAGE code: 0EA31



CAGE code: 79931, 0EA31

ESNA (MACLEAN-FOGG COMPANY)

611 COUNTRY CLUB ROAD
POCAHONTAS, AR 72455-8803

E, EN, or ESNA Red nylon insert in locknuts

Red nylon insert in locknuts identifies Esna as manufacturer



CAGE code: 019L2

ESP MANUFACTURING CO., INC.

2331 E. INTERSTATE 20
P O BOX 871
ODESSA, TX 79766-8827



CAGE code: 7J504

ESSENTIAL MACHINING

354 HERBERTSVILLE ROAD
BRICK, NJ 08724-1735



CAGE code: 0TR19

ESTA PRODUCTS COMPANY

16 MISSOURI DRIVE
WARWICK, RI 02886-8117



CAGE code: 8R230

EVERLOCK FASTENING SYSTEMS

EVERLOCK DETROIT DIVISION
6567 SOUTH STERLING DRIVE
STERLING HEIGHTS, MI 48077

Microlock



Hi-Hex Microlock



Prevailing torque surface

Flange Hi-Hex Microlock



Prevailing torque surface

Flange Toplock



Flange Nut



Nut and Washer Assembly



Standard Hex Nut



CAGE code:
(Continued)

EVERLOCK FASTENING SYSTEMS

(Continued)

GREER STOP NUT

(Greer-Smyrna Division)
481 McNALLY DRIVE
NASHVILLE, TN 37211

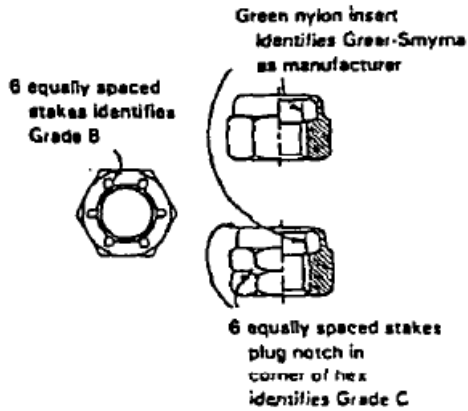

NYLON INSERT

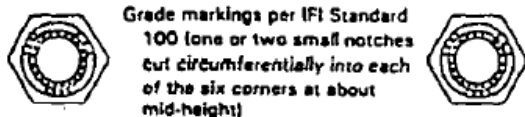

Grade B CONELOK INCH MARKINGS Grade C

Green nylon insert identifies Greer-Smyrna as manufacturer per IFI 514



Property Class 5, 9 and 10 markings per IFI 514 located on bearing surface and/or hex flats



NYLON INSERT

Manufacturer's I.D. - letter "G" stamped on one hex flat or on bearing surface



CONELOK - BEARING SURFACE

Class 5 METRIC MARKINGS Class 9 Class 10

CAGE code: 27687
(Continued)

(Continued)

EVERLOCK FASTENING SYSTEMS

INTERNATIONAL SCREW DIVISION
50631 EAST RUSSEL SCHMIDT BOULEVARD
MOUNT CLEMENS, MI 48045

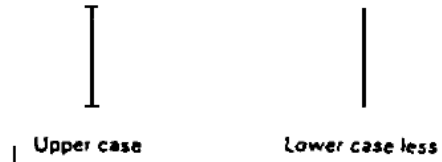

CAGE code:

EXCEL PRECISION PRODUCT'S, INC.

2207 NW 30TH PL.
POMPANO BEACH, FL 33069-1026

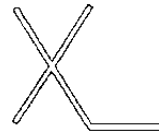

CAGE code: 1H4K6

EXPERIMENTAL MACHINE CO.

1412 SHOEMAKER RD.
BALTIMORE, MD 21209

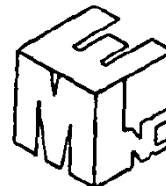

CAGE code: 0NAP8

EXTREME BOLT & FASTENER, LLC
280 E. MAIN STREET, SUITE 107
NEWARK, DE 19711

XBF

CAGE code: 73AB2

**EXTREME PRECISION SCREW
PRODUCTS, INC**
1838 REMELL ST.
FLINT, MI 48503

EPSP

CAGE code: 7Y769

FABER ENTERPRISES, INC.
6606 VARIEL AVE.
CANOGA PARK, CA 91303-2808

FE

CAGE code: 14397

FABRICATION SPECIALTY INC.
6530 SMOKY HILL CT.
GRANBURY, TX 76049-7042

FS or 28548

CAGE code: 28548

FABSCO CORP.
1745 W. 124TH ST.
CHICAGO, IL 60643-5345

FE

CAGE code: 4S619

FAILING CO., GEORGE E.
P.O.BOX 872
ENID, OK 73702

F

CAGE code:

FALCON MANUFACTURING CORP.
10409-B OLD ATLANTA HWY.
COVINGTON, GA 30014-0887

FMC
1

CAGE code: 0HM72

FALL RIVER MANUFACTURING CO., INC.

540 CURRANT ROAD
FALL RIVER, MA 02720-4711

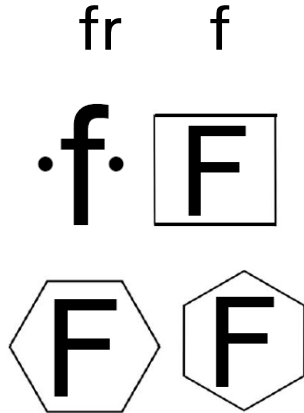

CAGE code: 1JWL5

FANG SHENG SCREW CO., LTD.

#113 LANE 96 MINCHAUN ROAD
LU CHU HSIANG, KAOHSIUNG HSIEN,
821, TAIWAN



CAGE code: SJ544

FARIAS INDUSTRIAL MACHINING

504 BRUNKEN AVENUE, STE L
SALINAS, CA 93901

(No artwork for marking. Marks whatever the customer specifies.)

CAGE code: 3KQY7

FARLO MACHINE & TOOL CO., INC

340 CONSTANCE DR
BLDG # 7
WARMINSTER, PA 18974-2815



CAGE code: 7S305

(FASSCO) FASTENER & STEEL SUPPLY CO., LTD.

QUALITY ASSURANCE DEPT.
P.O. BOX 236
HATFIELD, PA 19440

Plant
2294 NORTH ROAD
HATFIELD, PA 19440



Latest marking used
on fasteners after
August 1, 1988



Previous marking
used on fasteners

CAGE code:

FASTCO INDUSTRIES, INC.

P.O. BOX 141427
GRAND RAPIDS, MI 49514-1427

Plant
2685 MULLINS NW
GRAND RAPIDS, MI 49534

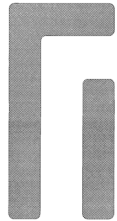

CAGE code: 56NH8

FASTENAL COMPANY

2001 THEURER BLVD.
WINONA, MN 55987-1500

Plant
FASTENAL COMPANY MFG DIV
1801 THEURER BLVD.
WINONA, MN 55987-1500
CAGE code: 1QNZ3

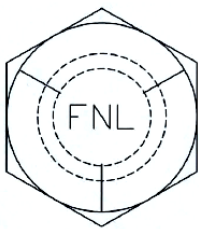

CAGE code: 0Y3H3

FASTENER BROKERAGE INC

DBA INOFAST MANUFACTURING INC.
SUITE R 2880 BERGEY RD
HATFIELD, PA 19440 - 3241



CAGE code: 2T359

FASTENER DIMENSIONS, INC.

94-03 104TH STREET
OZONE PARK, NY 11416

Plant
616 Atkins Avenue
Brooklyn, NY 11208

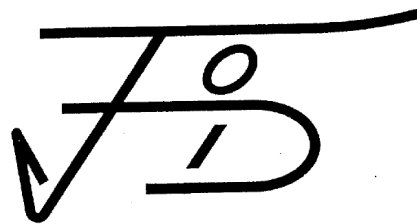

CAGE code: 7C3A5

FASTENER INNOVATION TECHNOLOGY, INC.

DBA F.I.T.
14601 S. BROADWAY STREET
GARDENA, CA 90248-1811



CAGE code: 58998

FASTENER TECHNOLOGY CORP.
7415 FULTON AVE
NORTH HOLLYWOOD, CA 91605-5411

FT

CAGE code: 58794

FASTENING PRODUCTS CO.,INC.
P.O. BOX 261
CLIFTON HIGHTS, PA 19018-0334

Plant
3 MERION TERRACE
CLIFTON HEIGHTS, PA 19018-0334



CAGE code: 6M389

FASTENERS UNLIMITED INC.
2150 WOODLAND ROAD
WARRENDALE, PA 15086

FUN

CAGE code: 47346

FASTENING PRODUCTS OF LANCASTER, INC.

1980 OLD PHILADELPHIA PIKE
LANCASTER, PA 17602-3498

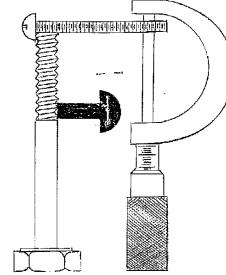

CAGE code: 4M097

FASTENRATH BEFESTIGUNGSTECHNIK GmbH

HERSCHEIDER STRABE 105
POSTFASH 51 42
58840 PLETTENBERG, HOLTAUSEN
FEDERAL REPUBLIC OF GERMANY

F

CAGE code:

FASTI-WERK CARL AUG. FASTENRATH GMBH & CO.KG

INDUSTRIEGEBIET ELBRINGHAUSEN
P.O. BOX 1250
WERMELSKIRCHEM, GERMANY 42929

F

CAGE code: D9500

FASTRON COMPANY, THE
11800 FRANKLIN AVENUE
FRANKLIN PARK, IL 60131-1006

F

CAGE code: 24929

FEDERAL EQUIPMENT COMPANY
707 CARR ST
CINCINNATI, OH 45203-1211

F E C

6 0 5 8 7

CAGE code: 60587

FEDERAL MANUFACTURING CORP.
9825 DE SOTO AVENUE
CHATSWORTH, CA 91311-1441

F M C

CAGE code: 17943

FEDERAL SCREW WORKS

2400 BUHL BUILDING
DETROIT, MI 48226

BIG RAPIDS DIVISION
400 NORTH DEKRAFT
BIG RAPIDS, MI 49307

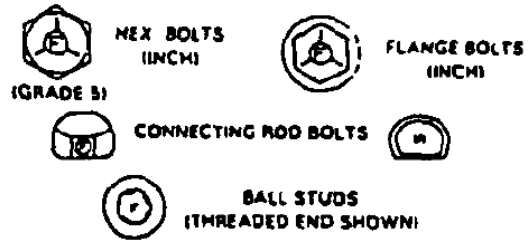

ROMULUS DIVISION
34846 GODDARD ROAD
ROMULUS, MI 48174-3400

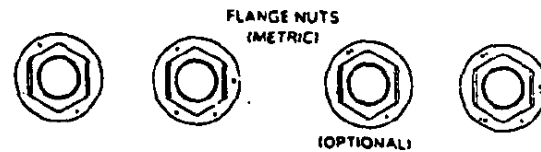
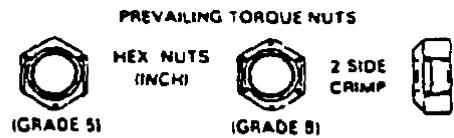

CAGE code: 21957

FENBAR PRECISION MACHINISTS, INC

633 COMMERCE STREET
THORNWOOD, NY 10594-1348



CAGE code: IP472

FENTON HEADING

2480 OWEN RD.
FENTON, MI 48430

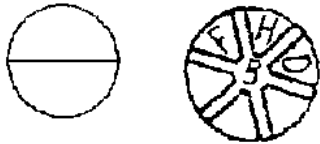

CAGE code:

FERNDALE FASTENER

31600 STEPHENSON HIGHWAY
MADISON HEIGHTS, MI 48071

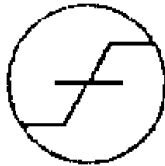

CAGE code:

FERRIERE DI STABIO, S.A.

VIA LAVEGGIO 6/A
CH-6855 STABIO
SWITZERLAND



CAGE code:

FERRY CAP & SET SCREW CO., THE

2151 SCRANTON RD.
CLEVELAND, OH 44113-3578



CAGE code: 84513

FIBAM COMPANHIA INDUSTRIAL

SAO BERNARDO DO CAMPO
P.O. BOX 360
SAO PAULO, BRAZIL C.E.P.0
09701.907

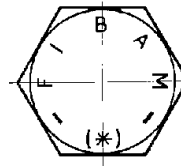

CAGE code:

**FILETAGE INTERNATIONAL
(INTERNATIONAL THREAD INC.)**

2225 RUE MICHLIN
LAVAL, QUE, CANADA H7L9Z7



CAGE code:

FIRST AMERICAN SALES CO.

2706 ST. LOUIS AVE.
LONG BEACH, CA 90806-2026



CAGE code: 58251

FISCHER SPECIAL MFG. CO.
11 INDUSTRIAL RD.
COLD SPRING, KY 41076-9796

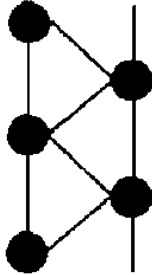

CAGE code: 73743

FITZ MANUFACTURING INDUSTRIES LTD
DBA FMI
6625 IRON HORSE BLVD.
NORTH RICHLAND HILL, TX 76180

05DT8

FTZ

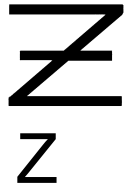

CAGE code: 05DT8

FLAIG & HOMMEL
HEERSTRASSE 1
ALDINGEN, GERMANY 78554

FS

Company logo to be stamped and used on all steel reusable FLAG & HOMMEL lock nuts.

FH

Company logo to be stamped on all none reusable (standard) nuts.

CAGE code: C3816

FLEXALLOY INC.
26000 RICHMOND ROAD
BEDFORD, OH 44146



GRADE 5
HEX HEAD
CAP SCREW



GRADE 8
HEX HEAD
CAP SCREW



FX-180 HEX HEAD
CAP SCREW
(180,000 PSI
MINIMUM TENSILE
STRENGTH)



FX-180 HEX NUT
PROOF LOAD =
180,000 PSI



METRIC CAP SCREW,
PROPERTY CLASS 10.9

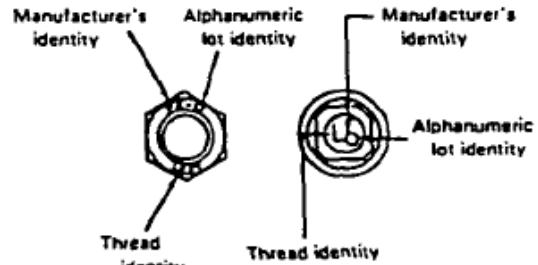

Outer Cap Wheel Nut

Inner Cap Wheel Nut

WHEEL NUTS



HEX FLANGE SCREW GRADE 8

CAGE code: 0C9A2

FLIP PERILLO FASTENERS, INC.
624 E. RANCHO VISTA BLVD.
PALMDALE, CA 93550

F P F

CAGE code: 6R9N7

FLORES ENTERPRISES

1729 E. 28TH STREET
SIGNAL HILL, CA 0806-1923



CAGE code: 0V616

FLUIDONICS INC.

205 W INDUSTRY CT
P. O. BOX 9020
DEER PARK, NY 11729



CAGE code: 58525

FLUIDYNE CORPORATION

9100 COLLINS AVE.
PENNSAUKEN, NJ 08110



CAGE code: 9Y957

FMW, INC.

7016 PUEBLO
WICHITA, KS 67209



CAGE CODE: 1QJK4

FOCUS HOPE

1355 OAKMAN
DETROIT MICHIGAN 48238



CAGE code: 00P13

FOCUS HOPE

1400 OAKMAN
DETROIT, MI 48238



CAGE code 6KWK9

FOLSOM TOOL & MOLD CORP.

12 MOUNT PLEASANT DR.
ASTON, PA 19014-4140



CAGE code: 6P049

FONTAL CONTROLS, INC.
12725 ENCINITAS AVENUE
SYLMAR, CA 91342-3517



CAGE code: 0GNC3

FONTANA S.A.
FONTANA LUIGI SPA
VIA PIAVE 29
VEDUGGIO MILANO,
ITALY 20050

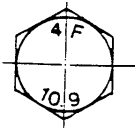
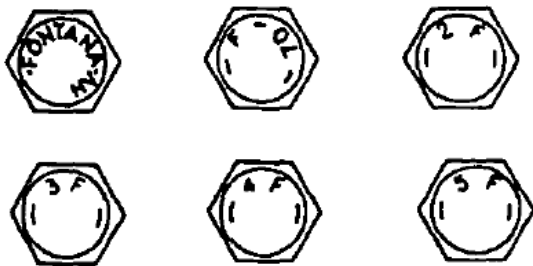

Bolts and screws
Hexagon Head
Strength Grade 10.9
Iso Metric Thread

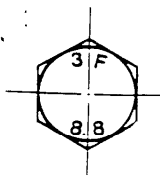

Bolts and screws
Hexagon Head
Strength Grade 8.8
Iso Metric Thread

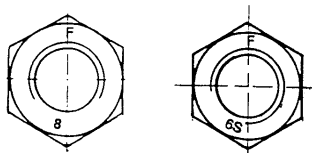

Nut
Strength Class 8
Iso Metric Thread

CAGE code: A4733

FOREMOST PRECISION INSTRUMENT CORP.

31 CARLETON AVE
MT VERNON, NY 10550-4617



CAGE code: 33464

FOREST FASTENERS

TREFOREST INDUSTRIAL ESTATE
PONTYPRIDD, MID. GLAMORGAN,
SOUTH WALES, UNITED KINGDOM
CF37 5YG



CAGE code:

FORMED FASTENER MANUFACTURING, INC.

7247 S. 78TH AVE
BRIDGEVIEW, IL 60455



CAGE code:

FPA MANUFACTURING

DBA FPA MANUFACTURING AND SUPPLY
6733 S SEPULVEDA BLVD STE 245
LOS ANGELES, CA 90045-1525



CAGE code: 0J6Z1

**FRANROE PRECISION MACHINE
COMPANY**

12 CHAMPION RD
GLOUCESTER CITY, NJ 08030

**F.R.
F.R.P**

CAGE code: 40650

**FREEHOLD MANUFACTURING ASSEMBLY
CO., INC.**

86 BIRCH AVENUE
PO BOX 269
LITTLE SILVER, NJ 07739

FM

CAGE code: 2S308

FREEMAN CO.

P. O. BOX 57
719 WALNUT ST
YANKTON, SD 57078

F

CAGE code: 84596

FRIEDR BOESNER GMBH

AUGUSTHENALER STRASSE
5450 NEUWIED 13
GERMANY

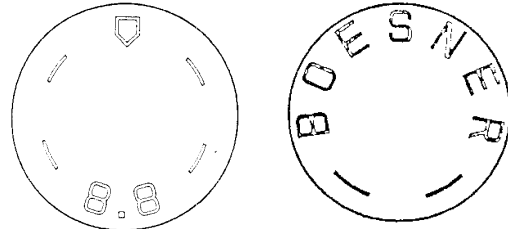

CAGE code:

FRISBY AEROSPACE INC DE

DIV TRIUMPH ACTUATION SYSTEMS -
CLEMMONS
417 S.MAIN ST.
FREEPORT, NY 11520-5144

was FRISBY AIRBORNE HYDROLICS, INC

FAH

CAGE code: 26437

FRONTIER BOLT COMPANY OF TEXAS

555 AIRPORT DRIVE
MANSFIELD, TX 76063-2715

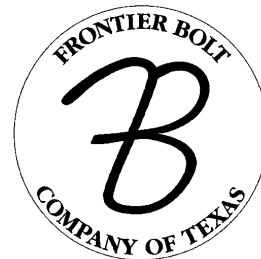

CAGE code: 1CE65

FUCHS SCHRAUBENWERK GmbH

BISMARCKSTRASSE 24
5900 SIEGEN
GERMANY D-57076

Hex head/round head bolts, stud bolts

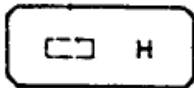

*T-head bolts,
hammer head/
hook head bolts*



*High strength
structural bolts
(tension controlled/
twist off)*

CAGE code:

G & R SCREW MACHINE PRODUCTS

21602 N. CENTRAL AVE.
SUITE 5
PHOENIX, AZ 85024

G & R

CAGE code: 7Y137

G & S MACHINE INC.

2804 RENEE DRIVE
BEDFORD, TX 76021-5208

G-S

CAGE code: 62925

G. B. MACHINE PRECISION, INC.

4140C AUSTIN BLVD
ISLAND PARK, NY 11558-1727

G.B.M

CAGE code: 03KF3

G.B. DUPONT CO., INC

500 WEST LONG LAKE ROAD
TROY, MI 48098



CAGE code:

GAITHER MACHINE

201 PILGRIM LANE
P. O. BOX 202
MUNFORD, AL 36268-4212

GMF

CAGE code: 1BTX4

GALAN PRECISION MACHINE CO.
8912 LANKERSHIM BLVD.
SUN VALLEY, CA 91352

G GPM

CAGE code: 0S1P8

GATES ALBERT, INC.
3434 UNION ST.
NORTH CHILI, NY 14514-9731

GAI

CAGE code: 4ZBMI

GALMAC MFG CO.
565 COVINA BOULEVARD
SAN DIMAS, CA 91773-2911

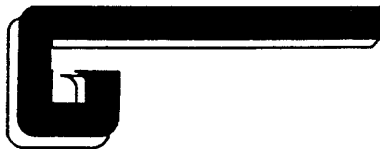

CAGE code: 4V765

GATEWAY SCREW AND RIVET, INC.
2670 UNINTED LANE
ELK GROVE VILLIAGE, IL 60007

G

CAGE code:

GARCIA INDUSTRIES, INC.
12345 FLORENCE AVENUE
SANTA FE SPRING, CA 90670-3807



CAGE code: 1RYN7

GEN FAST MANUFACTURING COMPANY
225 HENRY STREET, BLDG. 5
BRANTFORD, ONTARIO CANADA N3T 6H2



CAGE code:

GARDINER MFG. CO.
P.O. BOX 1499
OAKLAND, CA 94604



CAGE code: 24042

GENERAL AVIATION MFG., INC.
2693 PHILMONT AVE
HUNTINGDON VALLEY, PA 19006-5301

4J952

CAGE code: 4J952

GENERAL MACHINE PRODUCTS, INC.

3525 VICKERY BLVD
FORT WORTH, TX 76105

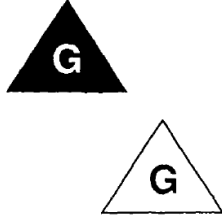

CAGE code:

GENERAL SCREW & SPECIALTY CO., INC.

14 N. BLEEKER ST.
MT VERNON, NY 10550



CAGE code: 26300

GERMAN MACHINED PRODUCTS, INC.

1208 S. HOOVER ST.
GARDENA, CA 90247-1771



CAGE code: 65813

GERTLER INDUSTRIES, INC.

914 W. 17TH STREET
COSTA MESA, CA 92627-4403



CAGE code: 64445

GFD LETAGE

ZONE INDUSTRIELLE
BP 63
BOURGNE
FRANCE 90140

Plant
15. IMPASSE G. THIVOLLET
P.O. BOX 26
42011 SAINT ETIENNE CEDEX 2
FRANCE



CAGE code: F1471

GILL MACHINE & TOOL CO.

200 PRAIRIE STREET
ROCKFORD, IL 61107

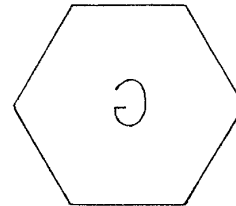

CAGE code: 0H8Y5

GL CNC SERVICE INC.

9860 OWENSMOUTH AVE #3
CHATSWORTH, CA 91311-3852



CAGE code: 1DUA6

GMJ MACHINE COMPANY, INC.

251 STATE LINE RD S
WILMER, AL 36587-7051



CAGE code: 8T119

GMP CO. CORPORATION

529 8TH AVE.
BETHLEHEM, PA 18018-5008



CAGE code: 51867

GOWER MACHINE LLC

128 MABEL LANE
EFFORT, PA 18330



CAGE code: 7VRU2

GOSHO WORKS, LTD.

3-8-1 TARU-MACHI
KOHOKU, YOKOHAMA
222 JAPAN



CAGE code:

GRACO INDUSTRIES, INC.

44605 MACOMB INDUSTRIAL DRIVE
CLINTON TOWNSHIP, MI 48096-1148



CAGE code: 1GT22

GRADON SCREW MACHINE CORP.

P. O. BOX 1080
1411 EAST ST.
NEW BRITIAN, CT 06050-1080



CAGE code: 69870

GRANDEUR FASTENERS, INC.

18798 E. HWY 10
DANVILLE, AR 72833-0658



CAGE code: 3U752

GRAUCH ENTERPRISES

RR 1 BOX 37
1878 PORT MATILDA HWY
PHILLIPSBURG, PA 16866-3128



CAGE code: 1HU38

**GREATER MARYLAND TOOL & MFG.,
CORP.**

5 RESOURCE AVE
MOUNTAIN LAKE PARK, MD 21550-6362



CAGE code: 34549

GREEN BAY DROP FORGE

DIV. OF CLEVELAND HARDWARE &
FORGING

1341 S. STATE ST.
P.O. BOX 11797
GREEN BAY, WI 54307-1797

See CLEVELAND HARDWARE & FORGING

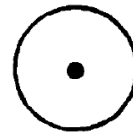

Circle with center dot

CAGE code: 08277

GREENFIELD MANUFACTURING CO., INC.

920 LEVICK STREET
PHILADELPHIA, PA 19111-5422

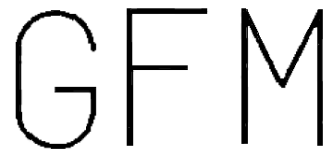

CAGE code: 98320

GREER STOP NUT

481 MCNALLY DRIVE
NASHVILLE, TN 37211-3311

G S_GL

Green nylon insert

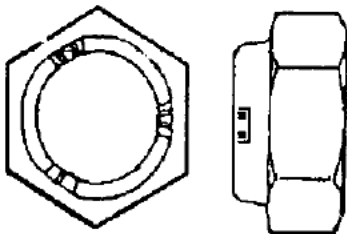

*Manufacturer identification:
2 raised ribs in (2) crimp depressions
1 raised rib in (1) crimp depression*

NFB

for head marking on
bolts and screws

CAGE code: 27687

GRIPCO, DIVISION OF BLACK & DECKER

111 E. BROAD ST.
SOUTH WHITLEY, IN 46787

GN

*Raised or indented on flange or
bearing surface of bolts*

*Raised on head of bolts, inch or
metric*

*Raised or indented on flange or
bearing surface of nuts*

GF



GN

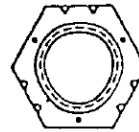

*Twin Delta
Crownlock grade
B inch locknut*

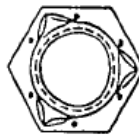

*Gripco Crown lock
Grade C inch
locknut*

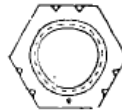

*Twin Delta
Crownlock
Class 9 metric
locknut*

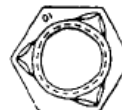

*Gripco
Crownlock
Class 10
metric locknut*



*Toplock
(3-6
Indentations)*



Centerlock

CAGE code: 0KS39

GROOV-PIN CORPORATION

331 FARNUM PIKE
SMITHFIELD, RI 02917-1205

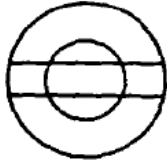

G-P

CAGE code: 73957

GRUPO RASSINI S.A. de C.V.
RASSINI INTERNATIONAL, INC.
617 EAST HURON STREET
ANN HARBOR, MI 48104

Plant
TORNILLOS RASSINI S.A. de C.V.
AV. ELECTRICIDAD Y.E. PUGIBEL
CD. INDUSTRIAL, XALOSTOC
STA. CARLA, EDO DE MEXICO
APARTADO POSTAL 14-711
MEXICO D.F.

RR

Used to mark the following products:

- hex cap screws
- hex bolts
- hex nuts
- heavy hex structural bolts
- heavy hex nuts
- shackle bolts
- hex cone nuts
- wheelbolts

CAGE code:

GS AEROSPACE

DIV. B & B SPECIALTIES INC
4321 E LA PALMA AVE.
ANAHEIM, CA 92807-1805

See B & B SPECIALTIES INC

1) PRIMARY - **GS**

2) SECONDARY - **GSAT**

3) SECONDARY - **1EM77**

4) SECONDARY - **GSI**
(OBSOLETE AS OF
JAN 1, 1988)

CAGE code: 1EM77

GSF FASTENING

MIDLAND ROAD
DARLASTON
WEDNESBURY, WEST MIDLANDS WS10 8JN
UNITED KINGDOM

see ARMSTRONG PRECISION
COMPONENTS LTD.



CAGE code:

GUARDIAN RIVET & FASTENER
GUARDIAN MANUFACTURING DIV
70 AIR PARK DRIVE
RONKONKOMA, NY 11779

Plant
201 TRADE ZONE DRIVE
RONKONKOMA, NY 11779



CAGE code:

GULF FASTENER, INC.

P.O. BOX 7188
MOBILE, AL 36670

Plant
267 BAY SHORE AVE.
MOBILE, AL 36670

GFX

CAGE code: 3Y5J5

GUNNISON-INTERNATIONAL INC.

861 GIBBSBORO ROAD
CLEMENTON, NJ 08021-1207

GTT

CAGE code: 4G922

**H C MERCHANDISERS INC. DBA H C
PACIFIC**

19844 QUIROZ CT
WALNUT, CA 91789-2828

**HC
HCP**

CAGE code: 53037

H C PACIFIC

19844 QUIROZ CT
WALNUT, CA 91789 - 2828

HC HCP

CAGE code: 53037

H. MULLINS, LTD.

BADE INDUSTRIAL ESTATE
JARROW TYNE AND WEAR CO
DURHAM, UNITED KINGDOM NE32 3EX

HM

CAGE code:

H. PAULIN & CO. LTD.

CAPITAL METAL INDUSTRIES DIVISION
55 MILNE AVE.
SCARBOROUGH, ONTARIO
CANADA MIL 4N3

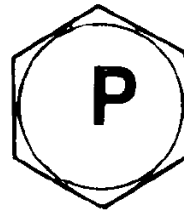

*Hex head cap
screws*



*Metric standard
hex head cap
screws*

CAGE code: 95119

**H. PRINZ GmbH FABRIK FUR
VERBINDUNGSELEMENTE**

5970 PLETTENBERG
POSTBOX 5241
GERMANY



CAGE code:

HABINA ENGINEERING

4740 COTTON BELT
SAN ANTONIO, TX 78219-2854

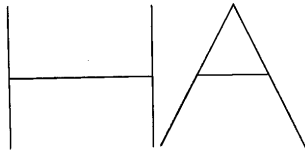

CAGE code: 1SZT7

HALL INDUSTRIES INC.

FORMERLY STANDARD TOOL & MACHINE
COMPANY
514 MECKLEM LANE
ELLWOOD CITY, PA 16117-3028



CAGE code: 29281

**HALLSIMS INDUSTRIAL COMPONENTS,
INC.**

37 TERRY DR.
TREVOSE, PA 19053



CAGE code: 8V986

HAMANAKA (THAILAND). CO., LTD.

NO. 550 Moo6 TAIBAN ROAD
AMPHUR MUANG, SAMUTPRAKARN,
THAILAND



Plant
HAMANAKA NUT MFG. CO., LTD
KO-770 SHIRAHANA-CHO,
HIMEJI-SHI HYOGO, JAPAN

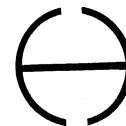

CAGE code: 5Z615

HANDI GADETS CORP.

P.O. BOX 0938
LA CROSSE, WI 54603

Plant
1230 CLINTON ST.
LA CROSSE, WI 54603

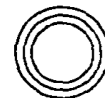

CAGE code: 1M893

HANSAN SCREW CO., LTD.
EXPORTING DEPARTMENT
974-7 YANG DUK-DONG
MASAN 610-00
KOREA

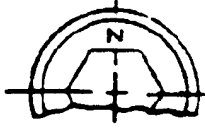

CAGE code:

HARDWARE SPECIALTY CO, INC.
48-75 36TH STREET
LONG ISLAND CITY, NY 11101-1994



CAGE code: 07679

HARRISON BOLT & NUT CO., THE
2781 WILKENS AVE.
BALTIMORE, MD 21223



CAGE code: 5B735

HARTFORD AIRCRAFT PRODUCTS, INC.
94 OLD POQUONOCK ROAD
BLOOMFIELD, CT 06002-1427



CAGE code: 66861

HARWOOD DESIGN, INC.
1507 CLYDE WAITE DRIVE
BRISTOL, PA 19007-2919

HDI

CAGE code: 1VQQ8

HASKELL OF HUNTINGTON, INC.
P.O. BOX 119
HUNTINGTON, WV 25706-0119

Plant
300 THIRD AVENUE
HUNTINGTON, WV 25701



300 Series Stainless Steel

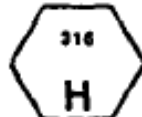

Type 316 Stainless Steel

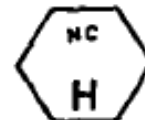

Nickel Copper (Monel)

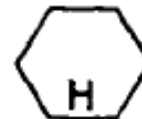

Silicon Bronze

CAGE code:

HASSALL, JOHN, INC.
609-1 CANTIAGUE ROCK RD
WESTBURY, NY 11590-1721



CAGE code: 82224

HATCH INDUSTRIES
17000 S WSTN AVE STE 22
GARDENA, CA 90247-5262



CAGE code: 03AJ8

HAWTHORNE BOLT WORKS
P.O. BOX 474
VALLEY CITY, OH 44280

Plant
355 A LAKE RD.
MEDINA, OH 44256

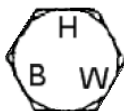

GRADE 2



GRADE 5



GRADE 8

CAGE code: 4TU98

HAYDON BOLTS, INC.
1181 UNITY ST
PHILADELPHIA, PA 19124-3104

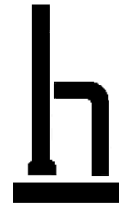

CAGE code: 2S013

HAZE SEIKO CO., LTD.
KO 402 SHIRAHAMA- CHO
HIMEJI-SHI, HYOUGO-KEN, JAPAN 672

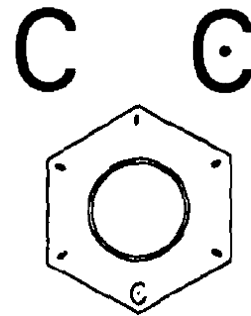

CAGE code:

MIL-HDBK-57J (GS7)
APPENDIX A

**HEARTLAND PRECISION FASTENERS,
INC.**

301 PRAIRIE VILLAGE DR
NEW CENTURY, KS 66031-1121

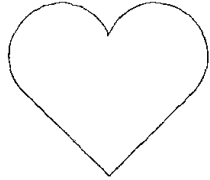

CAGE code: 0ZC92

HEMCO TOOL INC.

7 SOUTH MAPLE ST.
P.O. BOX 326
WESTFIELD, MA 01085-4338

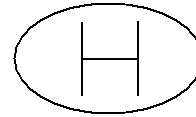

CAGE code: 5R108

HEIM'S MACHINE & TOOL, INC.

36 EVERGREEN ROAD
LEBANON, PA 17042

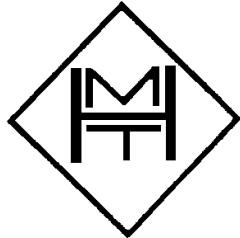

CAGE code: 0B117

**HENAN AEROSPACE PRECISION
MACHINING CO., LTD.**

NO. 13 BEIHUAN ROAD
HIGH-TECH INDUSTRY DEVELOPMENT
ZONE, XINYANG CITY
HENAN PROVINCE, CHINA 464000



CAGE code: SKG92

HEITCO MANUFACTURING, INC.

60 TUTTLE ROAD
MIDDLETOWN, CT 06457



CAGE code:



HENWAY, INC.

1314 GOODRICK DRIVE
P.O. BOX 1276
TEHACHAPI, CA 93561



CAGE code: 0X6T3

<p>HEPTNER MFG CO. RIVER ROAD BLDG. PP-1 JAY-CEE INDUSTRIAL PARK BRISTOL, PA 19007 - 6103</p> <p>7</p> <p>CAGE code: 05BZ4</p>
<p>HESSISCHE SCHRAUBENFABRIK WELTER GmbH & CO., KG STEPHAN-NIDEREHE-STR. 6 P. O. BOX 13 40 MARBURG, GERMANY 35037</p> <p></p> <p>CAGE code: D5396</p>
<p>HEWINS, EDMOND, C. JR. DBA JET MACHINE WORKS COMPANY 4519C WAYNE AVE PHILADELPHIA, PA 19144</p> <p>J</p> <p>CAGE code: 37KP5</p>
<p>HEXAGON ENTERPRISES, INC. 256 MINNESOTA AVENUE TROY, MI 48083</p> <p>HI</p> <p>CAGE code:</p>

<p>HG AEROSPACE ENGINEERING LTD ST LEONARDS-ON-SEA EAST SUSSEX TN38 9QS UNITED KINGDOM</p> <p></p> <p>CAGE CODE: KD652</p>
<p>HI INDUSTRIAL TECHNOLOGIES 241 WOODLAND AVE MORTON , PA 19070</p> <p></p> <p>CAGE code: 0SS65</p>
<p>HIGH QUALITY MACHINE SHOP 2775 WALSH ROAD SAN ANTONIO, TX 78224</p> <p>HQ</p> <p>CAGE code: 0B011</p>
<p>HIGH TECH ENTERPRISES 3299 SAN FERNANDO RD. UNIT 11 LOS ANGELES, CA 90065</p> <p>HTE.</p> <p>CAGE code: 0TSH2</p>

MIL-HDBK-57J (GS7)
APPENDIX A

HIGHLAND PRODUCTS CORPORATION

9331 MERCANTILE DRIVE
MENTOR, OH 44060-0452

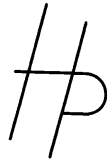

CAGE code: 0AKM4

HIGHLAND THREADS, INC.

FASTENER MANUFACTURING DIVISION
708 E. TIDWELL
HOUSTON, TX 77022-1822

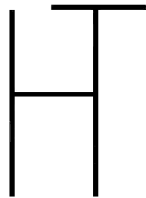

CAGE code: 1DT7C

HILL AEROSPACE & DEFENSE LLC.

19734 DEARBORN STREET
CHATSWORTH, CA 91311-6509



CAGE code: 55064

HILL FASTENER CORP.

P.O. BOX 399
ROCK FALLS, IL 61071

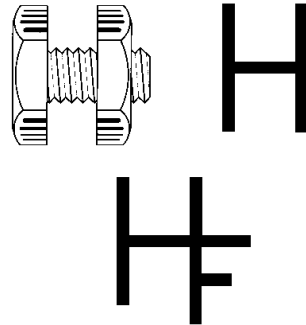

CAGE code: 4R119

HILL STAMPING & MFG., INC.

3202 C STREET N.E.
AUBURN, WA 98002-1789



CAGE code: 7M611

HILTI, INC.

5400 S. 122ND E. AVE
TULSA, OK 74121-6007

DX DIVISION

HILTI

H

ANCHOR DIVISION

HILTI

HEA M24 x 210

HILTI

HEA 3/4" x 6-5/8"

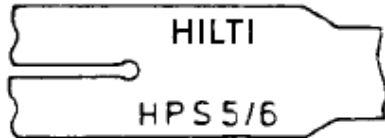
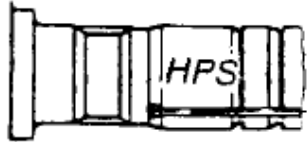

CAGE code: 11239

HI-SHEAR CORP.

DBA FOREIGN PARENT IS LISI PARIS
FRANCE

See listing for LISI
2600 SKYPARK DRIVE
TORRANCE, CA 90505



hs HS

hs

Plant
TORONTO FASTENERS
INDUSTRIES, INC.
Subsidiary of Hi-Shear Corp., USA
19 CONSTELLATION COURT
REXDALE, ONTARIO M9W 1K4,
CANADA

F

CAGE code: 73197

HLC INDUSTRIES INC.

6281 EMERALD LAKE DR
FARMINGTON HILLS, MI 48098



CAGE code: 0SC87

HMS SERVICES LLC
10039 WOLFRIVER
PLYMOUTH, MI 48170-4542

M

This is the headmarking for bolts and screws.
Headmark appears on the top of head.

M
M
M

This marking is for nuts. This mark
appears on the side of hex nuts.

CAGE code: 1UYL6

HO-HO-KUS, INC.
189-201 LYON ST.
PATERSON, NJ 07524

HK

CAGE code: 69370

HO HONG WORKS CO., LTD
10 CHUNG SHAN ROAD
LU CHU VILLAGE, KAOHSIUNG
HSIEN, TAIWAN 821

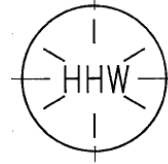

CAGE code:

HOFFMANN, RICHARD GMBH CO. KG
AM KIESWASSER 8-10
D-5940 LENNESTADT-ELSPE MEISELTER
WEG
KYLLEBURG, GERMANY 5524

Plant
HOFFMANN MACHINE COMPANY, INC.
1386 DREXEL ROAD
VALDESE, NC 28690

H

CAGE code: 0HEK2

HOLAN, INCORPORATED
1048 SANDY HILL ROAD
IRWIN, PA 15642

HI

CAGE code: 1JT30

HOLLYWOOD MANUFACTURING INC.
11915 VOSE STREET
NORHT HOLLYWOOD, CA 91605-5750

H

CAGE code: 7T729

HOLO-KROME CO.
31 BROOK STREET
WEST HARTFORD, CT 06110-2385

HK

*On some socket
screw products*



*1960 series cap
screws - old
design*



*1960 series cap
screws - present
design*

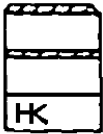

Metric socket cap



CAGE code: 74445

**HORSPOL & ROMINE MANUFACTURING
CO., INC.**

5850 MARSHALL STREET
OAKLAND, CA 94608-2696

HR HR

CAGE code: 95723

**HORST ENGINEERING &
MANUFACTURING CO.**

P.O. BOX 280066
EAST HARTFORD, CT 06108-2003

Plant
36 CEDAR ST
EAST HARTFORD, CT 06108

**HEM
HE HE**

CAGE code: 05812

HOUSTON FASTENER

DIVISION OF WESTBROOK MFG

1202 KRESS STREET

P.O. BOX 15614

HOUSTON, TX 77020

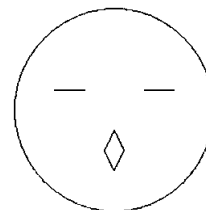

CAGE code: 0YN70

HOUSTON PRECISION FASTENERS
10018 TANNER ROAD
HOUSTON, TX 77041

HPF

CAGE code: 1VSL7

HOWIE MANUFACTURING CO., INC.
P.O. BOX 426
COLLINGSWOOD, NJ 08108

Plant
1227 MECHANIC ST.
CAMDEN, NJ 08104-1221

hmc

CAGE code: 9V802

HOWARD TOOL CO., INC.
547 ODLIN ROAD
BANGOR, ME 04401-6707

HT

CAGE code: 044B0

HOWE MACHINE AND TOOL CORP.
236 PARK AVE.
BETHPAGE, NY 11714-3709



CAGE code: 65777

HOWELL PRECISION, INC.
6 BROWN DRIVE
MOUND HOUSE, NV 89706-7744

HP

CAGE code: 6Y774

HUCK INTERNATIONAL INC.

NO LONGER IN BUSINESS

see ARCONIC FASTENING SYSTEMS &
RINGS

CARSON OPERATIONS
900 WATSON CENTER ROAD
CARSON, CA 90745-4201
CAGE code: 17446



LAKEWOOD OPERATIONS
3969 PARAMOUNT BLVD
LAKEWOOD, CA 90712-4193
CAGE code: 97928



TUCSON OPERATIONS
3724 E. COLUMBIA ST.
TUCSON, AZ 85714-3415
CAGE code: 0HDW7 (1G6U6 expired)



HUCK INDUSTRIAL PRODUCTS
8001 IMPERIAL DRIVE
WACO, TX 76714
CAGE code: 9K475



HUCK PRODUCTS
BP4, CLOS D'ASSEVILLE
95450 US PAR VIGNY
FRANCE
CAGE code: F6167



CAGE code: 17446, 1G6U6, 9K475, F6167,
0HDW7, 97928

HUGGINS MFG.

4314 GARLAND DR.
FORT WORTH, TX 76117



CAGE code: 0TCV6

HUGO DURHOLT GMBH & CO. KG

SCHRAUBENDREH-UND PREBWERK
POSTFACH 16-80
D-5632 WERMELSKIRCHEN
GERMANY



CAGE code:

HUNT VALVE COMPANY, INC.

DBA WAECO VALVE DIVISION
1913 EAST STATE STREET
SALEM, OH 44460



CAGE code: 11859

HUNTER STEVENS COMPANY

4003 FLEETWOOD AVE.
FRANKLIN PARK, IL 60131



CAGE code: 48093

HUNTINGTON VALLEY INDUSTRIES, INC
DBA HVI
15182 TRITON LN 101
HUNTINGTON BEACH, CA 92649-1041

HVI

CAGE code: 9S754

HURON AUTOMATIC SCREW CO.
P.O. BOX 610068
4914 GRATIOT RD
PORT HURON, MI 48061-0068

H

CAGE code: 00905

HURRICANE MACHINE COMPANY, L.L.C.
2644 FREEWOOD DRIVE
DALLAS, TX 75220

H

CAGE code: 1H7G3

HYDRO FITTING MFG. CORP.
733 E. EDNA PLACE
P.O. BOX 1558
COVINA, CA 91722-1409

HF

CAGE code: 13899

HYDROBOLT LIMITED
GLOBAL SERVICE CENTRE, MONMORE
BUSINESS PARK, DIXON STREET
WOLVERHAMPTON, WV2 2EE. U. K.

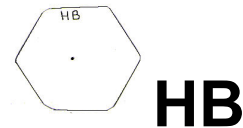

CAGE code:

I.G.D. MACHINE & TOOL LTD.
992 HUBREY ROAD
LONDON, ONTARIO, CANADA N6N 1B5



CAGE code:

IDEAL FASTENERS INC.
3850 E MIRALOMA AVE
ANAHEIM, CA 92806



CAGE code: 6F810

IFASTGROUPE 2004 LP

CANADA

SEE LISTINGS FOR:

INFASCO
700 OUELLETTE
MARIEVILLE, QUEBEC
CANADA
J3M 1P6
CAGE code: 1C225

INFASCO NUT
3990 NASHUA DRIVE
MISSISSAUGA, ONTARIO,
CANADA
L4VT IPG8
CAGE code: 06KL6

INGERSOLL FASTENERS
390 THOMAS STREET
INGERSOLL, ONTARIO
CANADA
N5C 3K3
CAGE code: 35571

IMPERIAL SUPPLIERS, INC.

P.O. BOX 11008
789 PACKER DR
GREEN BAY, WI 54304-4527

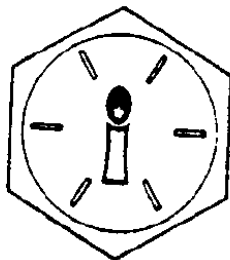

GRADE 8

CAGE code: 3A4R0

**INCO TECH AEROSPACE FASTENERS,
INC.**

12920 PIERCE STREET
PACOIMA, CA 91331

IA

CAGE code: 6VDQ4

INDIANA AIRCRAFT HARDWARE

221 SOUTH MAIN STREET
FORTVILLE, IN 46040-1514

IA

IAH

5N319

EM

EMF

GWF

CAGE code: 5N319

INDUSTRIAL & AUTOMOTIVE FASTENERS

DIVISION OF KEY MANUFACTURING GROUP, INC.

3200 W. FOURTEEN MILE RD.
ROYAL OAK, MI 48073

Inch Conelock Nuts

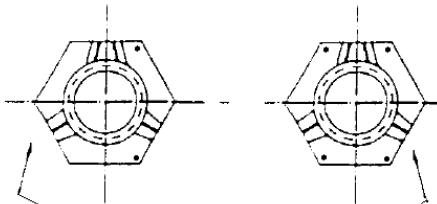

Company I.D.: 2 single & 1 double slash

Inch Wheelnut

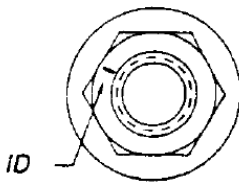

Metric Wheelnut

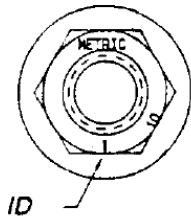

*Metric Flange Hex Nut
company ID: 1*

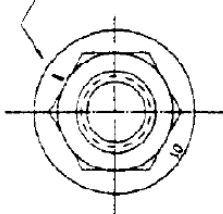

Metric Conelock Nut

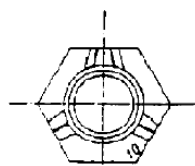

Company ID: 2 single & 1 double slash

Metric Capped Wheelnut

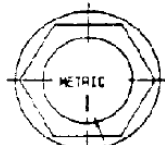

Company ID: 1

CAGE code:

INDUSTRIAL FASTENERS CORP.

7 HARBOR PARK DR
PORT WASHINGTON, NY 11050

Raised or indented marks

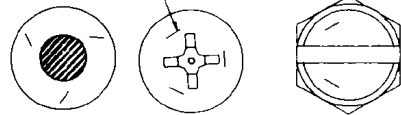

Under head

Top of head

*Slotted hexhead
(top of head)*

CAGE code: 84992

INDUSTRIAL FORGE, INC.

1725 US HWY 1 SOUTH
ALMA, GA 31510



CAGE code: 0RY28

INDUSTRIAL NUT CORP.

1425 TIFFIN AVE
SANDUSKY, OH 44870-2054

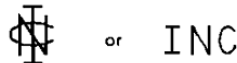

Blue nylon insert identifies INC as manufacturer

Blue nylon insert identifies INC as manufacturer per IFI 514

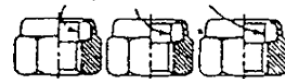

2 equally spaced stakes identifies property Class 5 per IFI 514



6 equally spaced stakes plus notch in corner of hex identifies Grade C



3 equally spaced stakes identifies property Class 9 per IFI 514

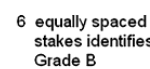

6 equally spaced stakes identifies Grade B



4 equally spaced stakes identifies property Class 10 per IFI 514



INCH NYLON INSERT LOCKNUTS



METRIC NYLON INSERT LOCKNUTS

The blue insert is a trademark of Industrial Nut Corp. registered in the U.S. Patent & Trade Office.

CAGE code: 81198

INDUX, S.A. DE C.V.

LAMINADORA 37
BELLAVISTA-TACUBAYA
MEXICO, D.F. 01140
MEXICO

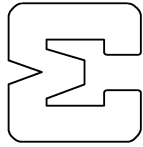

CAGE code: SDK76

INFASCO

see IFASTGROUPE 2004 LP
700 OUELLETTE
MARIEVILLE, QUEBEC
CANADA
J3M 1P6

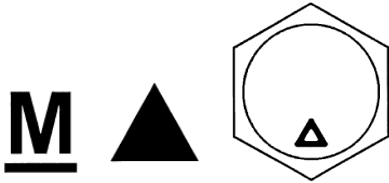

CAGE code: 1C225

INFASCO NUT

see IFASTGROUPE 2004 LP
3990 NASHUA DRIVE
MISSISSAUGA, ONTARIO,
CANADA
L4VT IPG8

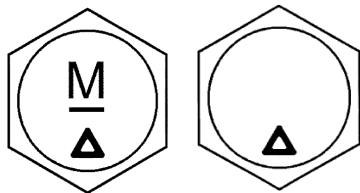

CAGE code: 06KL6

INFASCO DECORAH LLC

1301 KERR DRIVE
DECORAH, IA 52101-1802



IFORM



CAGE code: 5MQU3

INGERSOLL FASTENERS

see IFASTGROUPE 2004 LP
390 THOMAS STREET
INGERSOLL, ONTARIO
CANADA
N5C 3K3

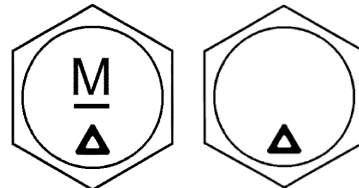

CAGE code: 35571

INLAND MACHINE COMPANY INC.

10762 EDISON CT.
RANCHO CUCAMONGA, CA 91730-4845



CAGE code: 6W617

INOFAST MANUFACTURING INC.

1370 INDUSTRY RD.
HATFIELD, PA 19440

IN

CAGE code: 2T359

IN-SPECK CORP.

208 EAST PENN ST
NORRISTOWN, PA 19401-1471

IS

CAGE code: 32904

INSTRUMENT MACHINING SERVICE LTD.

HOWLETT WAY, THETFORD,
NORFOLK IP24 IHZ
UNITED KINGDOM



CAGE code:

INTERFLEX MFG. CORP.

144 TOLEDO ST
FARMINGDALE, NY 75222-4429

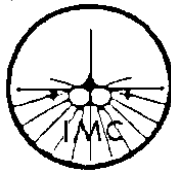

CAGE code: 0LD24

INTERSTATE FITTINGS INC.

2200 SINGLETON BLVD.
DALLAS, TX 75212



CAGE code: 1EHF9

IRON BOUND MANAGEMENT GROUP

79 SUMMIT AVE.
CHATHAM, NJ 07928

IMG

CAGE code: 5UKF4

IRVING MACHINE SERVICE, INC.

451 MAIN STREET
P.O. BOX 94
IRVING, NY 14081

IM

CAGE code:

IRWIN AUTOMATION, INC.

715 CLEVELAND STREET
GREENSBURG, PA 15601-1279

IRW

CAGE code: 7H803

ISLAND ENGINEERING

DBA J SMITH MACHINE SHOP INC
153 S MAIN ST
FREEPORT, NY 11520-0384



CAGE code: 40137

ITT HARPER AEROSPACE FASTENER OPERATIONS

AEROSPACE CONTROLS DIVISION
28150 INDUSTRY DRIVE
VALENCIA, CA 91355



CAGE code:

ITW BUILDEX

1349 WEST BRYN MAWR AVE.
ITASCA, IL 60143



CAGE code:

ITW CIP

850 STEAM PLANT ROAD
GALLATIN, TX 37066

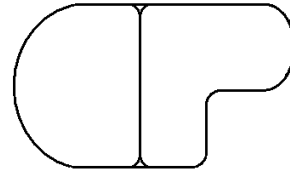

CAGE code: 50CR2

IVACO INC.

see IFASTGROUPE 2004 LP, CANADA

see listings for:

INFASCO
700 OUELLETTE
MARIEVILLE, QUEBEC
CANADA
J3M 1P6
CAGE code: 1C225

INFASCO NUT
3990 NASHUA DRIVE
MISSISSAUGA, ONTARIO,
CANADA
L4VT IPG8
CAGE code: 06KL6

INGERSOLL FASTENERS
390 THOMAS STREET
INGERSOLL, ONTARIO
CANADA
N5C 3K3
CAGE code: 35571

CAGE code: 1C225

J & M MACHINE INC.
1234 HIGH STREET
PAINESVILLE, OH 44077

1H423

CAGE code: 1H423

J & M MACHINING LLC.
24842 AVENUE ROCKEFELLER
VALENCIA, CA 91350



CAGE code: 75CK0

J & S PRECISION PRODUCTS
16 EVESBORO RD.
MEDFORD, NJ 08055-9592

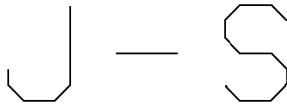

CAGE code: 8B865

J.F. FREDERICKS TOOL CO.
25 SPRING LANE
FARMINGTON, CT 06032-31 96

33575

CAGE code: 33575

J. G. FASTENERS
9720 COZYCROFT AVE
CHATSWORTH, CA 91311-4423



CAGE code: 0VWM9

J. GEORG BIERBACH
WERDOHLER STRASSE 23
ALTENA, GERMANY D-5990

G E B I



CAGE code:

J.M. PRECISION, INC.
FASTENER DIVISION
9722 TOPANGA CANYON BLVD
CHATSWORTH, CA 913114015



CAGE code: 0JV78

J.P. PRODUCTS, INC.
DBA SPECIALITES, UNLIMITED
P.O. BOX 427
WILLOUGHBY, OH 44094



CAGE code:

JACOBSON MFG., LLC.
941-955 LAKE RD.
MEDINA, OH 44256

CAGE code: 58PU8

Plant
JACOBSON MFG – TIFFIN, LLC.
1988 COUNTY ROAD #593
TIFFIN, OH 44883



CAGE code: 58UV4

JACO ENGINEERING, INC.
879 SO. EAST STREET
ANAHEIM, CA 92805-5356

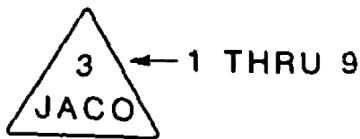

CAGE code: IH427

JAM TECH CORP.
P.O. BOX 327
ESSINGTON, PA 19029

Plant
1260 East Woodland Avenue
Springfield, PA 19064



CAGE code: IEM35

JAMES IPPOLITO & CO., INC.
1069 CONNECTICUT AVE.
BRIDGEPORT, CT 06607



CAGE code: 96458

JAMES JACKSON
DBA J J ENGINEERING
11021 VIA EL MERCADO
LOS ALAMITOS, CA 90720-0281



CAGE code: 0CEP4

JAMISON INDUSTRIES INC.
12669 DELTA ST
TAYLOR, MI 48180-6835



CAGE code: 1Z781

JANUS FASTENING SYSTEMS, INC.

2440 GERMANN ROAD, SUITE B5
CHANDLER, AZ 85286



CAGE CODE: 58BQ5

JAY BEE MACHINE WORKS, INC.

400 PIKE RD.
HUNTINGDON VALLEY, PA 19006-1610



CAGE code: 74954

JAY O MACHINE CO., INC.

7685 HUB PARKWAY
VALLEY VIEW, OH 44125-5706



CAGE code: 5Z832

JAYCO ENGINEERING, INC.

1660 BABCOCK AVENUE
COSTA MESA, CA 92627-4330



CAGE code: 7J578

JEA ENTERPRISES, INC.

P.O. BOX 512
MIDDLEBURY, CT 06762

Plant
86 BESSON RD.
MIDDLEBURY, CT 06762



CAGE code: 1S5U2

JERGENS INC.

DBA JERGENS INDUSTRIAL SUPPLY
15700 S WATERLOO RD
CLEVELAND, OH 44110-3814



CAGE code: 94882

JEWELL TOOL TECH

see KARMA INC
3129 STATE STREET
BEHENDORF, IA 52722



CAGE CODE: 1GW80

JINN HER ENTERPRISE CO., LTD.

107 SHIN LO STREET
KANGSHAN CHEN, KAOHSIUNG HSIEN
TAIWAN R.O.C.



CAGE code: NONE

JJ ENGINEERING

see JAMES JACKSON
11021 VIA EL MERCADO
LOS ALAMITOS, CA 90720-0281



CAGE code: 0CEP4

JJ SCREW PRODUCTS, INC.

21519 PARTHENIA STREET
CANOGA PARK, CA 91304



CAGE code: 75209

JMT MACHINE COMPANY

9986 GANTRY ROAD
PHILADELPHIA, PA 19115-1080

2A832

CAGE code: 2A832

JOHN R. BROMILEY COMPANY INC.

105 BRISTOL ROAD
CHALFONT, PA 18914

JRB

CAGE code: 1EV05

JOLICO/J-B TOOL INC.

4325 E. 22 MILE ROAD
UTICA, MI 48317-1507

JOLICO

CAGE code: 19549

JOSLYN CORP.

MACLEAN POWER SYSTEMS
11411 ADDISON STREET
FRANKLIN, IL 60131-1130

Plant
3700 SOUTH MORGAN STREET
CHICAGO, IL 60609-1461

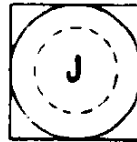

Machine bolts

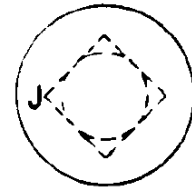

Carriage bolts

CAGE code: 74999

JUNIPER ELBOW CO.

72-15 METROPOLITAN AVE.
MIDDLE VILLAGE, NY 11379



CAGE code: 97537

JUPITER WASHERS, INC.

10-01 37TH AVE.
LONG ISLAND CITY, NY 11101-6014



CAGE code: 25900

K.A.A. COMPANY

LYNN ABADIE DBA K A A COMPANY
1309 MADISON STREET
WEATHERFORD, TX 76086-2144



CAGE code: 1XRQ5

JUST IN TIME, INC.

DBA APSCO
2538 WEST LN., SUITE 16
STOCKTON, CA 95205

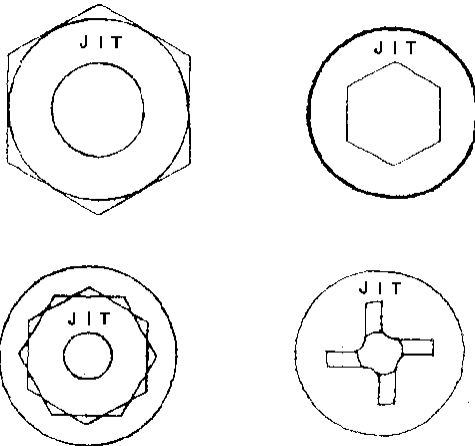

CAGE code: 0FVD5

K.D.K. UPSET FORGING CO.

2645 W. 139TH ST.
P.O. BOX 146
BLUE ISLAND, IL 60406-0146



CAGE code: 8P293

**KAMAX-WERKE RUDOLF KELLERMANN
GmbH & CO. KG**

PETERSHUETTER ALLEE 29
OSTRODE, GERMANY 37520



CAGE code: C5315

K & K PRECISION ENTERPRISES

60 STEAM WHISTLE DRIVE
WARMINSTER, PA 18974



CAGE code: 1K6D9

KAMAX L. P.

FORMERLY DUPONT, G.B. CO., INC.
500 WEST LONG LAKE ROAD
TROY, MI 48098-4540



CAGE code: 1DWW1

**KAMPWERK VIEREGGE U. PICKARDT
GMBH. & CO**

P.O. BOX 5143
PLETTENBURG 5 G-5970



CAGE code:

KAPCO INDUSTRIES, INC.

5660 KNOTT AVE
BUENS PARK, CA 90621

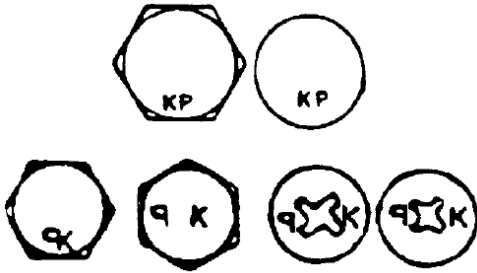

CAGE code: 0BMF4

KARMA INC

DBA JEWELL TOOL TECH
3129 STATE STREET
BEHENDORF, IA 52722



CAGE CODE: 1GW80

**KATSURAGAWA MACHINE SCREW CO.,
LTD.**

3-24-1 YAGUCHI OHTA-KU
TOKYO 146
JAPAN

Plant
366-1, KOGOSYO
KAKEGAWA-SHI
SHIZUOKA-KEN 436
JAPAN

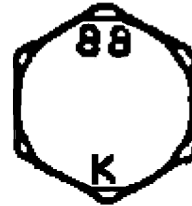

CAGE code:

KAYGOR, INC.

1243 TRANSIT STREET
P.O. BOX 2950
POMONA, CA 91769-2950



CAGE code: 4H229

KAYNAR PRODUCTS

800 S. STATE COLLEGE BLVD.
FULLERTON, CA 92831

NO LONGER IN BUSINESS

See ARCONIC FASTENING SYSTEMS &
RINGS

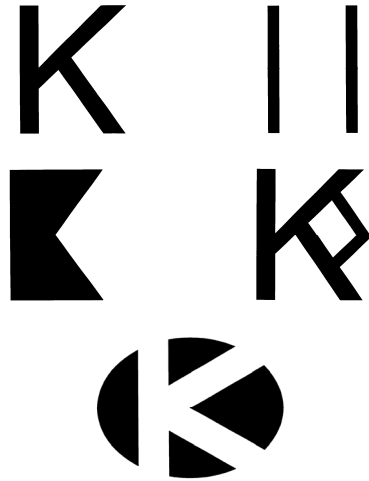

CAGE code: 15653

KELLER ENGINEERING

136 W. 157TH STREET
GARDENA, CA 90248-2226



CAGE code: 4W941

KELOX/MICRODOT PRODUCTS

3020 WEST LOMITA BLVD.
TORRANCE, CA 90505-5103

NO LONGER IN BUSINESS

see ARCONIC FASTENING SYSTEMS &
RINGS



CAGE code: 75237

KEN FORGING, INC.

1049 GRIGGS RD
P.O. BOX #277
JEFFERSON, OH 44047

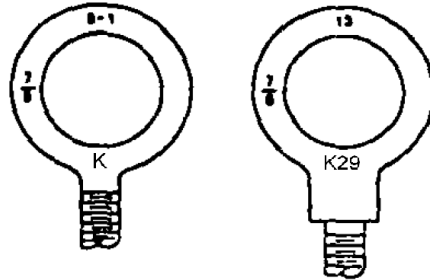

CAGE code: 1GMT9

KERR, CHARLES W.

RIVER RD BLDG PP-1
JAY CEE INDUSTRIAL PK
BRISTOL, PA 19007

see MAUI MEGA



CAGE code: 0M4F0

KERR LAKESIDE INC.

26841 TUNGSTEN RD.
P.O. BOX 32220
EUCLID, OH 44117-2680



CAGE code: 7P576

KEYSTONE BOLT & NUT COMPANY
KEYSTONE THREADED PRODUCTS
DIVISION
P.O. BOX 31059
CLEVELAND, OH 44313-0059

Plant
7621 OLD ROCKSIDE RD.
CLEVELAND, OH 44131-0059

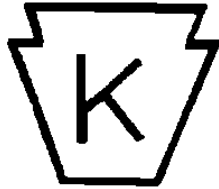

CAGE code: 4N487

KEYSTONE TOOL & MACHINE CO.
108 N. McDADE BLVD.
DARBY, PA 19023



CAGE code: 7Y516

KILBOURN ENGINEERING CO.
9226 WEST FLAGG AVE.
MILWAUKEE, WI 53225-2718



CAGE code: 8H824

KIRSTEN PIPE CO. INC.
1807 NW DOCK PL
P.O. BOX 70526
SEATTLE, WA 98127-0526

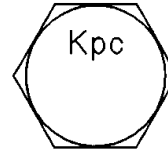

CAGE code: 5E704

K.L.M. MACHINE INC.
711 COLONIA LANE EAST
NOKOMIS, FL 34275



CAGE code: 4NDJ6

KLINCHER LOCKNUT CORP.
2030 N. OXFORD ST.
P.O. BOX 18100
INDIANAPOLIS, IN 46218



CAGE code:

KNIPPING-DORN GmbH
KALTUMFORMTECHNIK
4690 HERNE 1
POSTFACH 1229
GERMANY

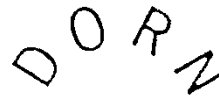

In connection with the identification mark of property class 3.6 up to and including 12.9

CAGE code:

KNOCH MANUFACTURING CO. LTD.

1054 SHAW RD
DORCHESTER, CANADA N0L 1G4

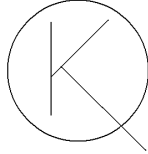

CAGE code: 1C763

KO AMS MACHINE PRODUCTS

DBA KOAM MACHINE
915 BROOKS ST UNIT 102
ONTARIO, CA 91762-3603



CAGE code: 0K7E0

KOBE FASTENER LIMITED

654 HISBIE
HIGASBI OSAKA, 577
JAPAN



CAGE code:

KOLB GMBH & CO.

HERSTELLER VON
VERBINDUNGSELEMENTEN
RATHENAU STRASSE 23
POSTFACH 24 02 53 WUPPERTAL
GERMANY 42277

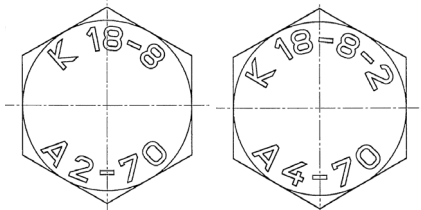

CAGE code: D0472

KONDOR TECHNOLOGIES, INC.

206 CHRISTOPHER ST
RONKONKOMA, NY 11779-6921



CAGE code: 06ZB0

KONGO BYORA CO., LTD.

2-1-27 SHITENNOJI
TENNOJI-KU
OSAKA 543 JAPAN

Plant
3-31 NAGATA-NISHI
HIGASHIOSAKA-SHI, OSAKA
577 JAPAN

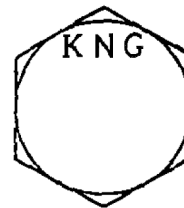

CAGE code:

KOREA BOLT IND., CO., LTD.

FOREIGN TRADE DEPARTMENT
620-34 GURO-DONG, GURO-KU
SEOUL, KOREA

Plant
732-3 WONSI-DONG, ANSAN-CITY
GYUNGGI-DO, KOREA



CAGE code:

KORODY COLYER CORP.
A CR INDUSTRIES COMPANY
5412 MCFADDEN AVE.
HUNTINGTON BEACH, CA 92649

K

CAGE code: 18954

KOZAK, E. PRECISION PRODUCTS CO.
45 WOODLAND AVE.
ROCKAWAY, NJ 07866

KPP

CAGE code: 1CP43

KPF
601 YOUNGTAN-DONG, CHUNGJU-CITY
CHUNGCHEONGBUK-DO 380-250, KOREA

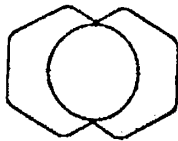

CAGE code:

KREIS TOOL & MFG., CO., INC.
1615 CAMBRIDGE DR
ELGIN, IL 60123 - 3114

KTM

CAGE code: 64592

KROBACH MANUFACTURING CORP.
3504 ARDEN RD.
HAYWARD, CA 94545-5390



CAGE code: 30828

KSS SOCKET SCREW, INC.
3416 S. 48TH STREET SUITE #6
PHOENIX, AZ 85040

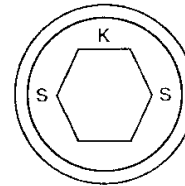

CAGE code: 0BMF5

K-TECH MFG., INC.
288 HOLBROOK DRIVE
WHEELING, IL 60090

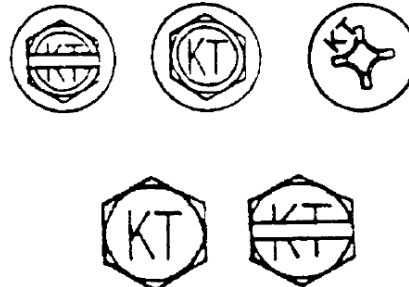

CAGE code:

KYOEI SEISAKUSHO CO., LTD.

4-5-11 NUNOICHI-CHO
HIGASHIOSAKA-SHI,
OSAKA 579
JAPAN

Plant
MINAMISHINOZAKI
KAZSHI, SAILAMA-KEN
347 JAPAN



CAGE code:

KYOKUTO MFG CO LTD.

3-5-29 WAKAEHONMACHI
HIGASHIOSAKA-SHI
OSAKA 578
JAPAN

Plant
1109-5 SHIBADE
KURAMOCHI-CHO,
NABARI-SHE, MIE-KEN 518-04
JAPAN



CAGE code:

L & C MANUFACTURING CO., INC.

8610 S. 33RD W. AVENUE
TULSA, OK 74132-3403



CAGE code: 43813

L & H THREADED RODS CORP.

DIV OF GRAY AMERICA CORP
3050 DRYDEN ROAD
DAYTON, OH 45439



CAGE code: 0UH42

L & J FASTENERS, INC.

3636 LACON ROAD
HILLIARD, OH 43026-6122

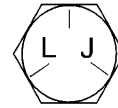

CAGE code: 1W358

L & M ENTERPRISES, INC.

1910 NORTHERN
WICHITA, KS 67216-2429



CAGE code: 0HDM5

L. A. MARTIN CO.

14400 HENN STREET
DEARBORN, MI 48126-1850



CAGE code: 9S775

L G MACHINE & MFG INC.

1276 W. ARKANSAS LANE
ARLINGTON, TX 76013-6235



CAGE code: 0P4S2

L H INDUSTRIES, INC.
TIP TOP TOOL CO.
3513 NORTH 10th STREET
PHILADELPHIA, PA 19140

44

CAGE code: 0E7S8

L N AEROSPACE, INC.
6011 TENSION DRIVE
FORT WORTH, TX 76112-2693

LNA

CAGE code: 1EB45

**L P R PRECISION PARTS AND TOOL
COMPANY, INC.**
108 ROME STREET
FARMINGDALE, NY 11735-2136

L. P. R.

CAGE code: 31583

L R G CORPORATION
210 MAGEE AVE
JEANNETTE, PA 15644-2136

LRG

CAGE code: 75783

LAKE ERIE SCREW CORP.
13001 ATHENS AVE.
LAKEWOOD, OH 44107-6201

LE



ASTM A 307



ASTM A 449



SAE J429 GR 5.1

SAE J429 GR 2

SAE J429 GR 5



ASTM A 354 BD

ASTM F 568
CLASS 8.8

SAE J429 GR 6

SAE J429 GR 8

SAE J1199
CLASS 8.8



ASTM F 568
CLASS 9.8

ASTM F 568
CLASS 10.9

ASTM F 568
CLASS 12.9

SAE J1199
CLASS 9.8

SAE J1199
CLASS 10.9



ASTM A 325



ASTM A 325
TYPE 3
CLASS A



ASTM A 490



ASTM A 490
TYPE 3
CLASS A

CAGE code: 8B911

LaMOTT ENTERPRISES, INC.
3905 CALIFORNIA STREET NE
MINNEAPOLIS, MN 55421



CAGE code: 3MWQ3

LAMSON AND SESSIONS OF CANADA LTD.

RB & W CORP. METAL FORMING DIVISION
8341 TYLER BOULEVARD
MENTOR, OH 44060

MANUFACTURER NUTS – Sales Office
Lamson & Sessions of Canada Ltd.
Toronto Plant – Canada
5190 Bradco Boulevard
Mississauga, Ontario L4W 1G7
CANADA

STOVER† PREVAILING TORQUE LOCKNUTS



Grade A Grade B Grade C

Hex Automation – Imperial



Grade F Grade G

Hex Flange – Imperial

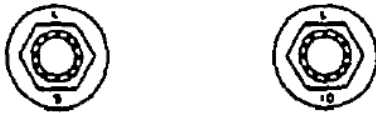

Class 9 Class 10

Hex Flange – Metric



Hex Automation – Metric

CAGE code:

LANA INDUSTRIES

4404-D MCLEAN DRIVE
HALTOM CITY
FORT WORTH, TX 76117



CAGE code:

LANARKSHIRE BOLT LTD.

BURNBANK
HAMILTON, LANARSHIRE ML3 OQU
SCOTLAND

L B

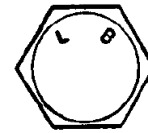

Raised letters

CAGE code: K3565

LAND-SEA-AIR MACHINED PRODUCTS, INC.

P.O. BOX H
FLEMING PIKE
WINSLOW, NJ 08095



CAGE code: 8U768

LANIS MACHINE & MFG., CO.

2506 S. COOPER #A-9
ARLINGTON, TX 76015-1608



CAGE code: 8V177

LANUM METAL PRODUCTS, INC.

4100 N. 16TH STREET
PHILADELPHIA, PA 19140-3008



L.M.T.

CAGE code: 0CY73

LAWSON PRECISION MACHINING, INC.

2981 CREST LANE ROAD
BUCYRUS, OH 44820



CAGE CODE: 1STC4

LBL PRODUCTS

5395 INDUSTRIAL DRIVE
UNIT A
HUNTINGTON BEACH, CA 92649-1516



CAGE code: 1HJ06

LEBRECHT TIGGES GmbH & CO. KG

P.O. BOX 12 04 85
W 5600 WUPPERTAL 12-CRONENBERG
GERMANY

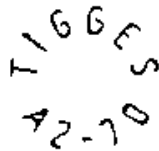

CAGE code:

LEE AEROSPACE PRODUCTS, INC.

90 WEST EASY STREET, UNIT #5
SIMI VALLEY, CA 93065



CAGE code: 9S874

LEHNER SCREW MACHINE CO.

71 SOUTH RIVER ROAD
P.O. BOX 158
MUNROE FALLS, OH 44262

Plant
71 SOUTH RIVER ROAD
MUNROE FALLS, OH 44262



CAGE code: 9G035

LELAND-POWELL FASTENERS, INC.

P.O. BOX 260
MARTIN, TN 38237

Plant
HIGHWAY 45 EAST SOUTH
MARTIN, TN 38237



CAGE code:

LENCH, THOMAS WILLIAM, LTD.

P.O. BOX 31
EXCELSIOR WORKS CARNEGIE ROAD,
ROWLEY REGIS B65 8BZ
UNITED KINGDOM



Raised letters



Indented letters



Raised or indented
letters

CAGE code: U0039

LENTERN (AIRCRAFT) LTD.

MAIN RD, HAWKWELL,
NR. HOCKLEY ESSEX SS5 4JJ
UNITED KINGDOM



CAGE code:

LEONARD JED CO.

MARYLAND BOLT AND NUT CO DIV
(REPLACES MARYLAND BOLT & NUT CO.,
INC. -CAGE 76213)
1104 RUSSELL ST.
BALTIMORE, MD 21230 - 2622



SAE J429 Grade 5
ASTM A449
MIL-B-857-A Grade 5

NOTE: Also covers round head bolts,
i.e., carriage-plow and countersunk
styles, etc.



ASTM A193 Grade B-7

Alloy steel high temperature service
bolting

Tempered to 125 KSI tensile strength

NOTE: Also covers sq. head and
countersunk styles.

Heavy head hex or regular configura-
tions



ASTM A490 Type 1

NOTE: Also covers round head bolts,
i.e., carriage-plow and countersunk
styles, etc.



ASTM A394 Type T-0

Tower bolts: hex head, square head

Head markings also include: T-1 for
medium carbon and T-3 for weather-
ing alloy steel. Both require heat
treating

NOTE: Round head step bolts require
manufacturing head identification
and proper markings as above,
except length size



SAE J429 Grade 8
ASTM A354 Grade 80

Also (optional) that A354 is exhibited
on top of head

MIL-B-857-A Grade 8

NOTE: Also covers round head bolts,
i.e., carriage-plow and countersunk
styles, etc.

CAGE code: 52373

Continued

MIL-HDBK-57J (GS7)
APPENDIX A

(Continued)
LEONARD JED CO.
MARYLAND BOLT AND NUT CO DIV



ASTM A325 Type 1
NOTE: Also covers round head bolts, i.e., carriage-plow and countersunk styles, etc.



With line under A325 mark

ASTM A325 Type 3
NOTE: Also covers round head bolts, i.e., carriage-plow and countersunk styles, etc.



No Grade mark — only manufacturer's symbol

SAE J429 Grade 2
ASTM A307 Grades A & B
MIL-B-857-A Type 2 (ADM/5)
NOTE: Also covers round head bolts, i.e., carriage-plow and countersunk styles, etc.



With line under A490 mark

ASTM A490 Type 3
NOTE: Also covers round head bolts, i.e., carriage-plow and countersunk styles, etc.



Letters B7M on head

ASTM A193 Grade B-7-M
Alloy steel high temperature service bolting
Tempered to 100 ksi tensile strength
NOTE: Also covers SQ head and countersunk styles
Heavy head hex or regular configurations



Heavy hex for type C-3
Regular or heavy for DH3

Manufacturer's symbol and the number 3 or DH3 on face
For Grade C-3 three radial lines are also required
Heavy hex applications for C-3 and heavy or regular for DH3
Nuts for bolt applications
ASTM A325 type 3
ASTM A563 Grade CH3
Also covers square nut configurations

CAGE code: 52373

(Continued)

(Continued)
LEONARD JED CO.
MARYLAND BOLT AND NUT CO DIV



Heavy or regular

Manufacturer's symbol and the 2H or DH marking
Also can be supplied in regular configurations
Suitable for all Grade 5 and A325 or A490 bolts
Nuts for bolt applications
ASTM A194 Grade 2H
ASTM A563 Grade DH
Also covers square nut configurations



Heavy hex only

Manufacturer's symbol and three radial lines
Heavy hex applications only
Nuts for bolt applications
ASTM A563 Grade C
For ASTM A325 bolts
Also covers square nut configurations

CAGE code: 52373

LEP SPECIAL FASTENERS INC.
3281 W. COUNTY RD ON/S
FRANKFORT, IN 46041



LE

CAGE code: 8B911

LEVEL 1 FASTENERS

777 10TH AVE WEST
HUNTINGTON, WV 25701

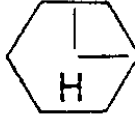

300 Series Stainless Steel

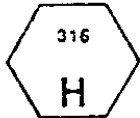

Type 316 Stainless Steel

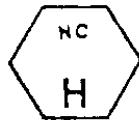

Nickel Copper (Monel)

BEK

CAGE code: 17283

LEVINGSTON MACHINE COMPANY

2428 MINNIS DR.
HALTOM CITY, TX 76117-4856

LM

CAGE code: 46939

LEWIS SCREW COMPANY

DIV OF MEDALIST FASTENERS INC.
2550 S 27TH AVE.
BROADVIEW, IL 60155 - 3851



LEWIS SCREW COMPANY
THE FASTENER SPECIALIST

120° INCLUDED ANGLE
RAISED.

INDENTED HEX HDS. AND
INDENTED HEX WASHER HDS.



LEWIS SCREW COMPANY
THE FASTENER SPECIALIST



3-DASH MARKS 120° APART
RAISED

UNDER HEAD UPON REQUEST
"NON-COUNTERSUNK HEADS ONLY"

CAGE code: 1AW87

LFC INDUSTRIES INC.

DIVISION RKR TECHNOLOGIES
P. O. BOX 5982
1221 CORPORATE DRIVE WEST
ARLINGTON, TX 76006-6103

LFC

CAGE code: 62384

LIGHTNING BOLT & SUPPLY, INC.
10626 SOUTH CHOTAW DRIVE
BATON ROUGE, LA 70815

LBS

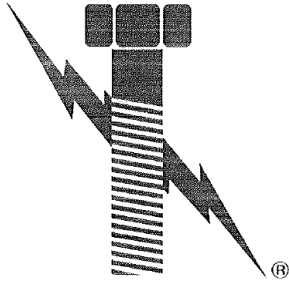

CAGE code: 3DA94

LINREAD NORTHBRIDGE
VIKING ROAD
WIGSTON, LEICESTER
UNITED KINGDOM, LE18 2BL

NO LONGER IN BUSINESS

see ARCONIC FASTENING SYSTEMS &
RINGS

NB

CAGE code: U6683

LINREAD NORTHBRIDGE
AIRCRAFT PRODUCT DIVISION
CROSSGATE ROAD, PARK FARM
REDDITCH, WORCESTERSHIRE B98 7TD
UNITED KINGDOM

see also ARCONIC FASTENING
SYSTEMS & RINGS

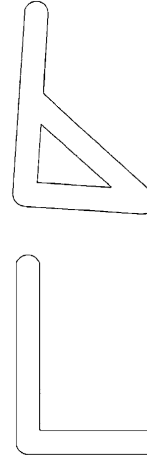

CAGE code: K8753

(Continued)

MIL-HDBK-57J (GS7)
APPENDIX A

(Continued)

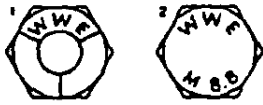



Illustration No.	Notes
1, 2	 = Unified S quality WWE = Linread Keeley St. (was Warne Wright Engineering and which no longer trades under that name) M = Metric screws and bolts 8.8 or 8.8 = Grade 8.8. Alternative markings such as 10.9 or 10.9 may appear as appropriate.



Illustration No.	Notes
3, 4	LL or L = Linread Ltd S = Unified S quality. Alternative letters such as R and T may appear as appropriate. M = Metric screws and bolts 8.8 or 8.8 = Grade 8.8. Alternative markings such as 10.9 or 10.9 may appear as appropriate.

Illustration No.	Notes
3, 4. (Cont'd)	 = Linread Pic

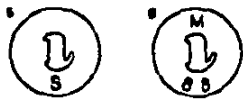

CAGE code: K8753

(Continued)

(Continued)

LINREAD PUBLIC LIMITED CO.
(AIRCRAFT PRODUCTS DIVISION)
P.O. BOX 28, CROSSGATE ROAD
PARK FARM INDUSTRIAL EST. REDDITCH,
WORCESTERSHIRE B98 7TD
UNITED KINGDOM



Illustration No.	Notes
5, 6	 = Linread Pic S = Unified S quality. Alternative letters such as R and T may appear as appropriate. M = Metric screws and bolts 8.8 or 8.8 = Grade 8.8. Alternative markings such as 10.9 or 10.9 may appear as appropriate.



Illustration No.	Notes
7, 8	 = Tribular screws and bolts. Various letters may appear, viz M = Metric. Absence of other letters indicate Duo-Taptite or Taptite parts. P = Powerlok C = Carbon restored surface, i.e., with no decarburization permitted but not case hardened. N = Neutral or through hardened I = Induction hardened lead threads S = Unified S quality. Alternative letters such as R and T may appear as appropriate. 8.8 or 8.8 = Grade 8.8. Alternative markings such as 10.9 or 10.9 may appear as appropriate.

CAGE code: K8753

LIPPISCHE EISENINDUSTRIE GmbH
ALTER WEG 57
D-4930
GERMANY

LE

CAGE code:

LISI AEROSPACE
LISI AEROSPACE CANADA
TOUR GAMMA A
193, RUE DE BERCY
75582 PARIS CEDEX 12
FRANCE

Plant
A1 TECHNOLOGIES
7022 ALONDRA BLVD
PARAMOUNT, CA 90723 3926

NO SYMBOL LISTED

CAGE code: 3N586

Plant
LISI AEROSPACE CANADA
2000, PLACE TRANSCANADIENNE
DORVAL (QUÉBEC) H9P 2K5
CANADA

L

CAGE code: L4528

(Continued)

(Continued)

VAUS

Plant
BLANC AERO INDUSTRIES
VILLEFRANCHE DE ROUERGUE
18, RUE JEAN VAURS
12200 VILLEFRANCHE DE ROUERGUE
FRANCE

P 

CAGE code: FAWT4

Plant
BLANC AERO INDUSTRIES RUGBY
RUGBY WARWICKSHIRE
CV21 3 RQ
UNITED KINGDOM

hs

CAGE code: U6300

Plant
BLANC AERO INDUSTRIES SAINT
OUEN L'AUMONE
95310 SAINT OUEN L'AUMONE
FRANCE

T 

→ (Sr Briec)
B (Paris)
P (Villefranche de
Rouergue)

ds. F

CAGE code: F0188

(Continued)

MIL-HDBK-57J (GS7)
APPENDIX A

(Continued)

Plant
BLANC AERO TECHNOLOGIES
B.P. 215
22002 SAINT BRIEUC CEDEX 1
FRANCE

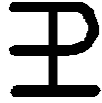

CAGE code: F0188

Plant
BLANC AERO INDUSTRIES VIGNOUX
Z.A. La Landette
18500 VIGNOUX-SUR-BARANGEON
FRANCE



CAGE code: F6427

Plant closed
DECOLLETAGE GENERAL MODERNE
DECOLLETAGE MODERNE 5 BIS, PLACE LEON
BLUM



Plant
FT BESTAS
35410 GAZIEMIR-IZMIR
TURKEY

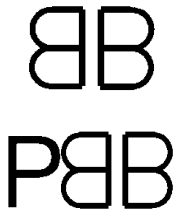

CAGE code: T0802

(Continued)

(Continued)

Plant
FTB FASTENER TECHNOLOGY
BESTAS
EGE SERBEST BOLGESI AYFER SOK NO 21
35410 GAZIEMIR-IZMIR
TURKEY



CAGE code: T0802

Plant
HI-SHEAR CORPORATION
see HI-SHEAR
260 SKYPARK DR.
TORRANCE, CA 90509-2975

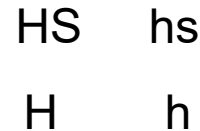

CAGE code: 73197

Plant
THE MONADNOCK COMPANY
16728 EAST GALE AVE
CITY OF INDUSTRY, CA 91745-1803

• (a dot)

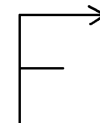

CAGE code: 60119

LITTLE WORLD MANUFACTURING, INC.

1083 FOREST RD.
WEST CHESTER, PA 19380

Plant
525 WEST SOUTH STREET
KENNETT SQUARE, PA 19348

L<W>M

CAGE code: 6T569

LLOYD MACHINE & TOOL CO., INC.

234 BROAD AVENUE
WILMINGTON, CA 90744-5812

LM

CAGE code: 01334

LN AEROSPACE, INC.

6011 TENSION DRIVE
FORT WORTH, TX 76112-2693

LNA

CAGE code: 1EB45

LOBO OFFICINE MECCANICHE SPA

VIA T. EDISON
CORANAREDO, MILANO ITALY 20010

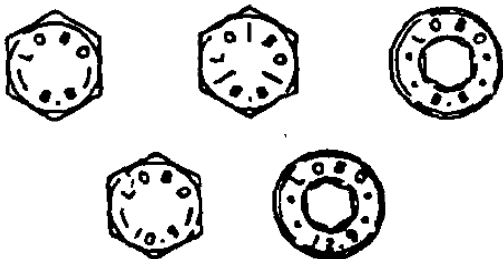

CAGE code: A1208

LOBO SYSTEMS LTD

26 THE PARKER CENTRE
MANSFIELD ROAD
DERBY
DE21 4SZ
UNITED KINGDOM

LOBOTM

CAGE code: KE018

LONESTAR FASTENERS

24131 HARDY ROAD
SPRING, TX 77373

L

Precedes grade marking
(example: LB7)

LSF

CAGE code: 7H174

LONG-LOK FASTENERS CORP.

10630 CHESTER RD
CINCINNATI, OH 45215-1206

Plant
14119 CHADRON AVE.
LOS ANGELES, CA 90250

CAGE code: 03038

LL or LONG
LOK or LL

CAGE code: 16941, plant 03038

LOOS & CO., INC.

AEROSPACE FASTENERS DIVISION
ROUTE 101
POMFRERT, CT 06258-0098

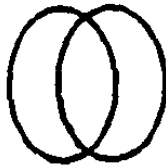

CAGE code: 59157

LORD CORPORATION

AEROSPACE PRODUCTS DIVISION
1635 WEST 12TH STREET
P.O. BOX 3694
ERIE, PA 16508 – 0694

CAGE code: 0PJN4



Plant
MECHANICAL PRODUCTS
DIVISION
4644 WADSWORTH RD.
DAYTON, OH 45414 – 4220

CAGE code: 30061



CAGE code: 0PJN4, 30061

LOUGHLIN MANUFACTURING CORP.

1580 RAILROAD AVE
HOLBROOK, N.Y. 11741-2301



CAGE code: 65782

M & M MANUFACTURING CORPORATION

5611 KIMBALL CT
CHINO, CA 91710



CAGE code: 0X598

M.A.A. CORP,
MID AMERICA AEROSPACE DIVISION
16201 WEST 110TH STREET
SHAWNEE MISSION, KS 66285



CAGE code:

M.L.W. MANUFACTURING CO.
P.O. BOX 8445
NEW HAVEN, CT 06511

Plant
240 SARGENT DRIVE
NEW HAVEN, CT 06511



CAGE code: 0GH69

M.S. AEROSPACE
13928 BALBOA BLVD.
SYLMAR, CA 91342-1005



CAGE code: 0UCY9

MAC FASTENERS, INC.
11110 ENTERPRISE ST.
OTTAWA, KS 66067-3803

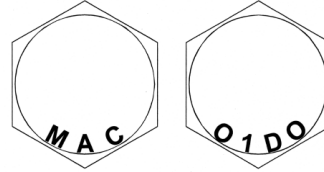

GOTHIC LETTERS "MAC"

GOTHIC LETTERS AND
NUMERAL "O1DO"

CAGE code: ORFT4

MACHINE SHOP, INC., THE
470 AIR PARK RD
ATWATER, CA 95301



CAGE code: 8T052

MACHINERITE CORP.
SYCAMORE & MILL RDS.
CLIFTON HTS, PA 19018



CAGE code: 7J299

MACHINING LOGISTICS, INC.
6640 VIEW PARK CT.
RIVERSIDE, CA 92503



CAGE code: 57LP7

MACK, A. W. MFG CO.
516 DUTCHESS TURNPIKE
POUGHKEEPSIE, NY 12603



CAGE code: 32448

MACKO INDUSTRIES
HWY 39 AT FM RD. 1340
P.O. BOX 170
HUNT, TX 78024-0170



CAGE code: 1CN43

MACKSON MFG CORP.
2338 SOUTHWAY DRIVE
ROCK HILL, SC 29730

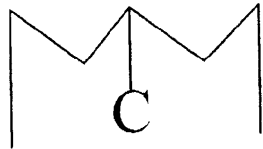

CAGE code: 093Y9

MACLEAN SKY
5989 RICCKENBACKER ROAD
COMMERCE, CA 90040



CAGE code: 1CNU4

MACLEAN-ESNA
(formally Elastic Stop Nut)
611 COUNTRY CLUB RD.
POCAHONTAS, AR 72455

E

EN

ESNA

RED NYLON INSERT INDICATES
MACLEAN-ESNA AS
MANUFACTURER

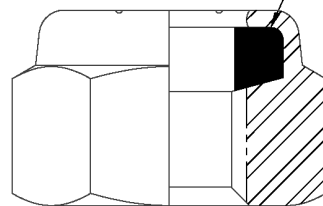

CAGE code: 019L2

MACLEAN-FOGG CO.

2551 WACKER RD.
SAVANNA, IL 61074

*Flange nuts less lock and with
Uni-Torque® lock
Two raised bars*

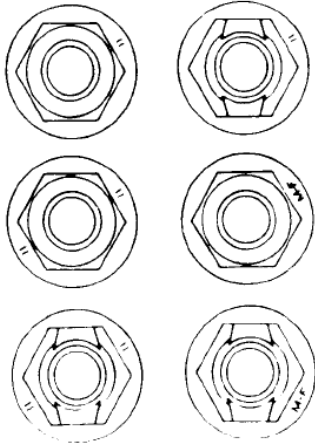

Hex and flange screws/bolts

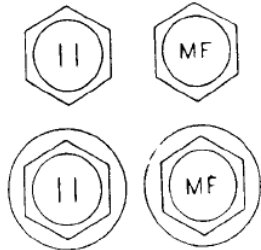

Hex nuts and Uni-Torque® locknuts

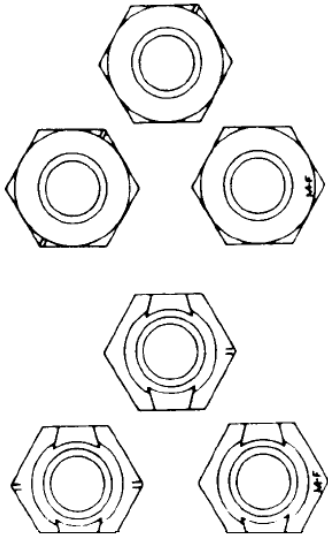

CAGE code: 0AMX8

MACOR, INC.

130 HOFFMAN LN
CENTRAL ISLIP, NY 11722



CAGE code: 2A269

MAGNUM MACHINE SHOP

768 HOMEWARD PL
SAN JOSE, CA 95123-2906

1YFG0

CAGE code: 1YFG0

MAGNUS TOOL & DIE CO., INC.

256 SHEFFIELD ST.
MOUNTAINSIDE, NJ 07092

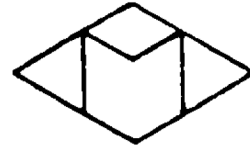

CAGE code: 37752

MAILLY MFG CO., INC.

P. O. BOX 6143
45 WAKELEE ROAD
WOLCOTT, CT 06716-2620



CAGE code: 3L606

MAIN MACHINE CO INC.
DBA MAIN MACHINE & TOOL CO
116 MARINE STREET
FARMINGDALE, NY 11735-5608

MMT

CAGE code: 05879

MANUFACTURING ENGINEERING TECH.
2758 AIELLO DR.
SAN JOSE, CA 95111-2134



CAGE code: 1CC57

MANUFACTURING SALES AND SERVICE
10631 BLOOMFIELD AVE #16
LOS ALAMITOS, CA 90720



CAGE code: 1S9V3

MANUFACTURING TECHNOLOGY SERVICES

111 CLINTON ROAD
FAIRFIELD, NJ 07004

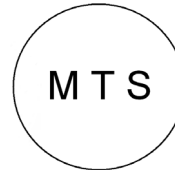

CAGE code: 4WCW0

MAPECO PRODUCTS, INC.
725 GLEN GLOVE AVE.
P.O. BOX 6
GLEN HEAD, NY 11545



CAGE code: 4P839

MAR-BRO MFG., INC.
5717 W. WASHINGTON STREET
PHOENIX, AZ 85043-3650

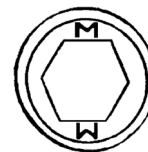

CAGE code:

MIL-HDBK-57J (GS7)
APPENDIX A

MARTIN-CHANDLER, INC.
122 EAST ALONDRA BOULEVARD
GARDENA, CA 902



CAGE code: 22625

MARUYKO NUT CO., LTD.
2-4-15 NAKANO-CHO, HIGASHI
TONDABAYASHI-SHI
OSAKA 584
JAPAN



CAGE code:

MARVIN ENGINEERING, CO.,INC.
260 WEST BEACH AVENUE
INGLEWOOD, CA 90302-2903



CAGE code: 32067

MARYLAND BOLT & NUT CO., INC.
LEONARD JED CO
1104 RUSSELL ST.
BALTIMORE, MD 21230-2622



SAE J429 Grade 5
ASTM A448
MIL-B-857-A Grade 5

NOTE: Also covers round head bolts.
I.e., carriage-plow and countersunk
styles, etc.



ASTM A193 Grade B-7
Alloy steel high temperature service
bolting
Tempered to 125 KSI tensile strength

NOTE: Also covers sq. head and
countersunk styles.
Heavy head hex or regular configura-
tions



ASTM A490 Type 1

NOTE: Also covers round head bolts.
I.e., carriage-plow and countersunk
styles, etc.



ASTM A394 Type T-0
Tower bolts: hex head, square head
Head markings also include: T-1 for
medium carbon and T-3 for weather-
ing alloy steel. Both require heat
treating

NOTE: Round head step bolts require
manufacturing head identification
and proper markings as above,
except length size

CAGE code: 76213(canceled)
Replaced by 52373

(Continued)

(Continued)

MARYLAND BOLT & NUT CO., INC.



SAE J429 Grade 8
ASTM A354 Grade BD
Also (optional) that A354 is exhibited
on top of head
MIL-B-857-A Grade 8

NOTE: Also covers round head bolts,
i.e., carriage-plow and countersunk
styles, etc.



ASTM A325 Type 1
NOTE: Also covers round head bolts,
i.e., carriage-plow and countersunk
styles, etc.



With line under
A325 mark

ASTM A325 Type 3
NOTE: Also covers round head bolts,
i.e., carriage-plow and countersunk
styles, etc.



No Grade mark
— only manu-
facturer's
symbol

SAE J429 Grade 2
ASTM A307 Grades A & B
MIL-B-857-A Type 2 (ADM/5)

NOTE: Also covers round head bolts,
i.e., carriage-plow and countersunk
styles, etc.



With line under
A490 mark

ASTM A490 Type 3
NOTE: Also covers round head bolts,
i.e., carriage-plow and countersunk
styles, etc.



Letters B7M on
head

ASTM A193 Grade B-7-M
Alloy steel high temperature service
bolting
Tempered to 100 ksi tensile strength
NOTE: Also covers SQ head and
countersunk styles
Heavy head hex or regular configura-
tions

CAGE code: 52373

(Continued)

(Continued)

MARYLAND BOLT & NUT CO., INC.



Heavy hex for
type C-3

Regular or
heavy for DH3

Manufacturer's symbol and the num-
ber 3 or DH3 on face

For Grade C-3 three radial lines are
also required

Heavy hex applications for C-3 and
heavy or regular for DH3

Nuts for bolt applications

ASTM A325 type 3

ASTM A563 Grade DH3

Also covers square nut configurations



Heavy or
regular

Manufacturer's symbol and the 2H or
DH marking

Also can be supplied in regular config-
urations

Suitable for all Grade 8 and A325 or
A490 bolts

Nuts for bolt applications

ASTM A194 Grade 2H

ASTM A563 Grade DH

Also covers square nut configurations



Heavy hex only

Manufacturer's symbol and three radial
lines

Heavy hex applications only

Nuts for bolt applications

ASTM A563 Grade C

For ASTM A325 bolts

Also covers square nut configurations

CAGE code: 52373

MASTER BOLT & MFG. INC.

811 TAYLOR STREET
ELYRIA, OH 44035

MB

CAGE code: 5CBB1

MASTER RESEARCH & MFG., INC.

13528 PUMICE ST
NORWALK, CA 90650 - 5249



CAGE code: 9U245

MAUI MEGA

DBA KERR, CHARLES W
JAY-CEE INDUSTRIAL PARK
RIVER RD. BLDG. PP-1
BRISTOL, PA 19007

see KERR CHARLES W



CAGE code: 0M4F0

MASTERBILT, INC

P.O. BOX 3715
South Bend, IN 46619

Plant
3801 VOORDE DR
SOUTH BEND, IN 46628



CAGE code: 02RW7

MCADAMS MACHINE AND TOOL CO.

2853 E FLORENCE AVE
HUNTINGTON PARK, CA 90255



CAGE code: 0UUE2

MASTERCRAFT TOOL COMPANY

13743 SHORELINE CT E
EARTH CITY, MO 63045 - 1202



CAGE code: 2M351

MCCULLOUGH AERO CO.

DBA MCCULLOUGH & ASSOCIATES
23891 MADISON STREET
TORRANCE, CA 90505-6008



CAGE code: 04273

MAUDLE INDUSTRIAL CO., LTD.

1-20 TSAO HU ROAD
TALI CITY, TAIWAN 41245



CAGE code: SH978

MCLANE MFG INC.
P. O. BOX 438
7210 ROSECRANS AVE.
PARAMOUNT, CA 90723 - 0438



CAGE code: 52706

McMELLON BROS INC.
915 HONEYSPOT RD.
STRATFORD, CT 06615 - 7192

05141



CAGE code: 05141

MD3 INDUSTRIES LTD
108 W HOLLOWAY DR
HURST, TX 76053 - 6807

See EMPIRE PRECISION MACHINING

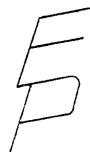

CAGE code:

MEACO PRODUCTS CORP.
99 PECK HILL ROAD
JOHNSTON, RI 02919-4510

M



MCO

CAGE code: 032Z0

MEC WOLF SRL
VIA MILANO, 5
22036 ERBA (CO) ITALY

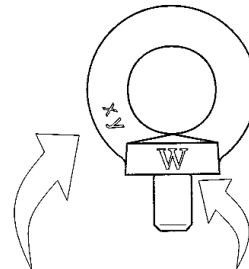

The lot identification "xy" (letter + numb.) is embossed on the ring.

The manufacturer's mark "W" is embossed on the crown.

CAGE code:

MECAERO PRODUCTS

BD DU GRAND CASTING
ROQUES-SUR-GARONNE
31128 PORTET SUR GARONNE CEDEX
FRANCE

NO LONGER IN BUSINESS

see ARCONIC FASTENING SYSTEMS &
RINGS



M

CAGE code: F7411

MECAERO CANADA INC.

2250 COHEN
VILLE ST-LAURENT
QUEBEC, H4R 9Z7
CANADA

MC

CAGE code:

**MECAIR AEROSPACE INDUSTRIES
SUBSIDIARY OF SPS TECHNOLOGIES DIV
DIVISION OF SPS TECHNOLOGIES**

DBA MECAIR INC
225 LABROSSE
PT. CLAIRE, CANADA H9R 1A3

MC

CAGE code: 0HL40

MECHANICAL & INDUSTRIAL FASTENERS

1145 JANSEN FARM DRIVE
ELGIN, IL 60123

MI

MIF

MIF

CAGE code: 0P8N1

MECHANICAL INDUSTRIES LLC

8900 NORTH 51ST STREET
MILWAUKEE, WISCONSIN 53223-2402

M I

CAGE code: 1U732

MEL-BA MANUFACTURING INC.

777 SUGAR LN
ELYRIA, OH 44035 - 5631

..MEL-BA..

CAGE code: 3A092

MERCER PRODUCTS & MFG. CO., INC.

401 S. WEBSTER STREET
SEATTLE, WA 98108 - 4137



CAGE code: 30205

MERCURY AEROSPACE INC.

20320 PRARIE STREET
CHATSWORTH, CA 91313

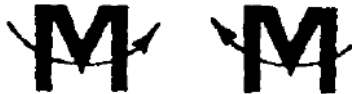

M - Mercury

- Aerospace

CAGE code: 50945

MERCURY TOOL & MACHINE, INC.

P.O. BOX 5190
WACO, TX 76708-5190

Plant
AIRPORT DRIVE & ZOO PARK DR.
WACO, TX 76708-5190



CAGE code: 01982

METALCRAFTERS

DIVISION OF KEYSTONE CONSOLIDATED
INDUSTRIES

4500 KISHWAUKEE STREET
P.O. BOX 7005
ROCKFORD, IL 61125-7005

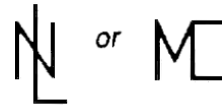

Indented hex & hex washer heads

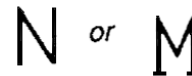

Hex cap screws - low carbon steel



Mis. markings for screws & bolts

CAGE code:

METAL-TECH MFG. INC.

1445 SOUTH 18TH ST.
CLINTON, IA 52732-6703



CAGE code: 3BNL5

**METHODS AND MACHINING SERVICES
CO.**

140 UXBRIDGE ST
CRANSTON, RI 02920-4811



CAGE code: 0FYD8

MIL-HDBK-57J (GS7)
APPENDIX A

METRO TOOL & MANUFACTURING CO.

see ALEXANDER MANUFACTURING
COMPANY INC
2402 ARKANSAS LANE
GRAND PRAIRIE, TX 75052-7203



CAGE code: 2M919

MI. ME. AF. S.r.l.

C.so EUROPA, 240
24032 CALOZIOCORTE (BG)
ITALY



CAGE code:

METRIX MFG. CO.

840 BRITTAN AVE.
SAN CARLOS, CA 94070-4181



METRI METRIX

CAGE code:

**MICRO SCREW MACHINE PRODUCTS,
INC.**

71 ROOSEVELT AVE
CARTERET , NJ 07008

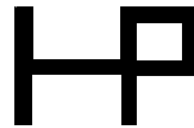

CAGE code: 43808

MEXEM WORKS

NO:24 SAFAK MAHALLESİ 5043. SOKAK
07220 ANTALYA, TURKEY



CAGE code: TH592

MICRODOT INC.

MICRODOT AEROSPACE FASTENING
SYSTEMS GROUP ADVANCED PRODUCTS
DIV

190 W CROWTHER AVE
PLACENTIA, CA 92670 - 5687



**KAYNAR TECHNOLOGIES INC
MICRODOT DIV**

800 SOUTH STATE COLLEGE BOULEVARD
PLACENTIA, CA 92670 - 5687
CAGE code: 1EJY4

NO LONGER IN BUSINESS

see KAYNAR PRODUCTS



*Used on sheet metal or stamped
products.*



Used on forged or foreign products



*Two parallel lines used on Spirallock®
products only*



Used on metric products



*Used on miscellaneous and general
Kaynar products*

MICRODOT INSERTS DIVISION

10 S. LA SALLE STREET
SUITE 3500
CHICAGO, IL 60603
CAGE code: 51204



*Three parallel lines spiralok insert
products only*

CAGE code: 0BPE9

MID CONTINENT SCREW PRODUCTS CO.

3701 WEST LUNT AVE.
LINCOLNWOOD, IL 60712



CAGE code: 1QMD3

MID-STATES SCREW CORP.

1817 EIGHTEENTH AVENUE
ROCKFORD, IL 61101



CAGE code: 17264

MIDWEST ACORN NUT CO.

256 MINNESOTA AVE.
TROY, MI 48083



CAGE code: 98960

MILE-HI MACHINE, INC.

6395 WEST 56TH AVE.
ARVADA, CO 80002



CAGE code: 1M949

**MILITARY & COMMERCIAL FASTENER
CORP.**

11 GRUMBACHERR350 RD.
YORK, PA 17404

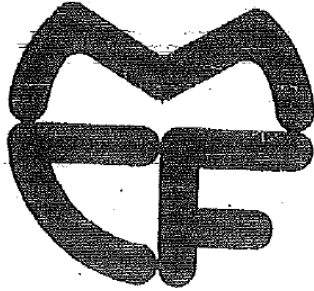

CAGE code: 9R350

MILITARY PRODUCTS GROUP, INC.

37190 SUGAR RIDGE ROAD
NORTH RIDGEVILLE, OH 44039-3630



CAGE code: 3DJB1

MILLIPART, INC.

412 W. CARTER DRIVE
GLEN DORA, CA 91740-5968



CAGE code: 31095

MILLS, J. R. MACHINING, INC

815 McCORD HOLLOW ROAD
HOHENWALD, LEWIS, TN 38462

(DLT-22)
B

N-N

(DLT-22)
N

CAGE code: 0LT22

MIL-SPEC FASTENERS CORP.

314 HANOVER PIKE
HAMPSTEAD, MD 21074-9999



CAGE code: 356S3

MINEBEA CO. LTD
FUJISAWA MANUFACTURING UNIT
1-1-1 KATASE, FUJISAWA CITY
KANAGAWA 251-8531
JAPAN



Trademark, Takyo Rashi

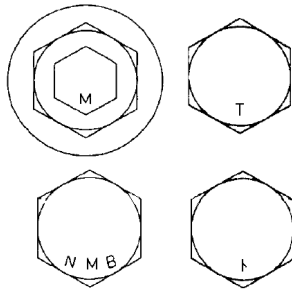

CAGE code: SB962

MIROFINE COMPANY
1940 W. 144TH STREET
GARDENA, CA 90249-2928

MFR 1L071

CAGE code: 1L071

MI-TECH, INC.
6685 JET PARK DRIVE
N. CHARLESTON, SC 29406-4700

MI-TECH, INC.

CAGE code: 9J758

MITSUBOSHI INDUSTRIES, LTD.
OSAKA DIVISION
4-16-1 CHOME, MIDORIGI
SUMINOE-KU, OSAKA 559
JAPAN

N
NK
NKYM

CAGE code:

MIX TOOL CO.
212 E. CEDAR STREET
COMPTON, CA 90220



CAGE code: 27643

MKM MACHINE TOOL COMPANY INC.
100 TECHNOLOGY WAY
JEFFERSONVILLE, IN 47130-9644

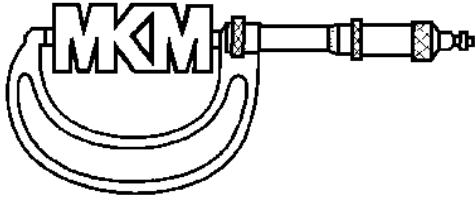

CAGE code: 8L583

M-MANUFACTURING
P.O. BOX 897
ROANOKE, TX 76272

Plant
HYW. 114 & DOVE RD.
ROANOKE, TX 76262



CAGE code:

MMG ENGINEERED COMPONENTS INC.
DBA TOOLSOURCE

3901 N. CARNATION
FRANKLIN PARK, IL 60131-1201

SOCKET HEAD
CAP SCREWS

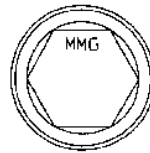
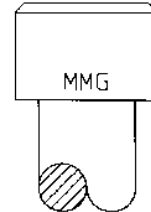
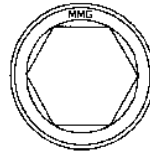

HEX HEADS
(GRADE 8)

HEX HEADS
(GRADE 5)

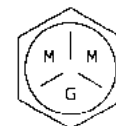
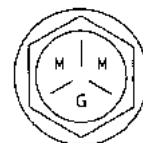

OTHER

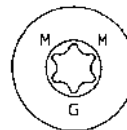
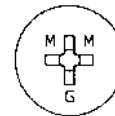

CAGE code: 3JMF9

MNP CORPORATION

P.O. BOX 189002
UTICA, MI 48318-9002

MNP FASTENER DIVISION
44225 UTICA RD
UTICA, MI 48317
CAGE code: 3R364

PLANT 2
MNP CORPORATION DIVISION 2
1524 E 14 MILE RD
MADISON HEIGHTS, MI 48071-1542
CAGE code: 064S9

PLANT 4
MNP PRECISION PARTS
1111 SAMUELSON RD.
ROCKFORD, IL 61109
CAGE code: 4S2M4

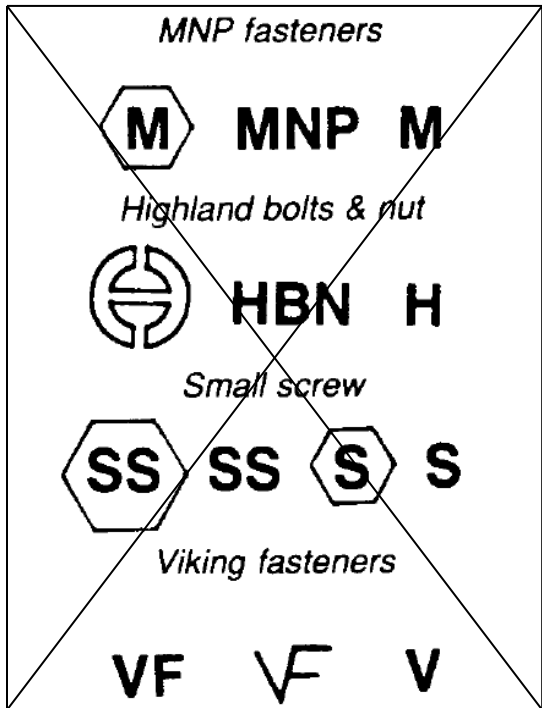
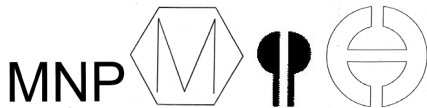

CAGE code: 3R364, 064S9, 4S2M4

**MODERN METRIC MACHINE COMPANY
INC**

101 W. NICHOLSON ROAD
AUDOBON, NJ 08106-1411



CAGE code: 1F6H56

MODFORM-ILLINOIS, INC.

500 36TH ST
EAST MOLINE, IL 61244



CAGE code: 46501

MONADNOCK COMPANY, THE

18301 ARENTH AVE.
CITY OF INDUSTRY, CA 91748-1228

NO LONGER IN BUSINESS

see LISI AEROSPACE

. (a dot)



CAGE code: 60119

MONOGRAM AEROSPACE FASTENERS

3423 SOUTH GARFIELD AVE.
LOS ANGELES, CA 90040-3103

FASTENER HEAD MARKINGS



SCRIPT "N"

Used on Visu-Lok® blind fasteners

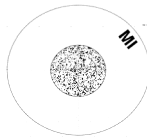

SCRIPT "MI"

Used on Composi-Lok®, OSI-Bolt®, Ti-OSI™, Radial-Lok®, Maf honeycomb pins, and other blind fasteners

BODY MARKINGS

**MONOGRAM
WEDGELOCK**



Trademark "WedgeloK" or "Monogram", depressed. Used on temporary fasteners

CAGE code: 98524

MONROE MACHINED PRODUCTS, INC.

1422 S. 192nd ST
SEATTLE, WA 98148-2314



CAGE code: 7F311

MONTEREY MACHINE PRODUCTS

1504-A INDUSTRIAL PARK STREET
COVINA, CA 91722-3417

MP

CAGE code: 1UD00

MORTON FASTENERS INC.

4544 RUNWAY DR.
LANCASTER, CA 93536

MFI

CAGE code: 4DU57

MORTON MANUFACTURING

17341 W. SIERRA HIGHWAY
SANTA CLARITA, CA 91351-1162

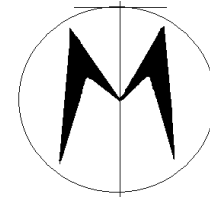
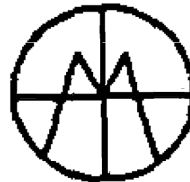

CAGE code: 2T498

**MOSE ENGINEERING AND
MANUFACTURING INC.**

4743 NW 72ND AVE
DORAL-MIAMI, FL 33166

AIC

CAGE code: 705N1

MOSTAR GEAR & MACHINE MFG., CO.

201 E. FRANKLIN
PALESTINE, IL 62451

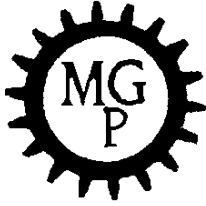

CAGE code: OHN25

MOTOR WHEEL CORP.

4000 COLLINS RD.
LANSING, MI 48910

Plant
1600 N. LARCH STREET
LANSING, MI 48906

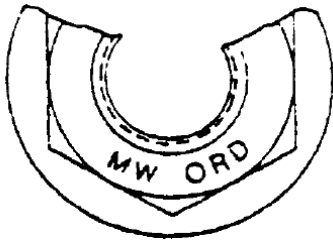

CAGE code: 4H871

MPIRE FASTENERS

21446 HARVILL AVENUE
PERRIS, CA 92570



CAGE code: 6D6C7

MRL MANUFACTURING CORP.

P.O. BOX 8440
59 LEE AVE
HALEDON, NJ 07508

Plant
525 LAFAYETTE AVENUE
HAWTHORE, NJ 07506



CAGE code: 0GUF9

N.S.S. INDUSTRIES

9075 GENERAL DRIVE
PLYMOUTH, MI 48170



CAGE code:

NAFCO USA, LLC

2900 LOCKHEED WAY
CARSON CITY, NV 89706



CAGE code: 32387

**NAGOYA SCREW MANUFACTURING CO,
LTD.**

17-16 TSUBAKI-CHO I
NAKAMURA-KU NAGOYA-SHI
AICHI-KEN, JAPAN

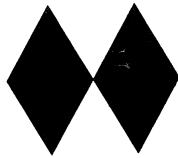

NRS

CAGE code: SC006

NAPIER'S AUTO BODY

49879 HWY 101 STH.
P. O. BOX 278
BRANDON, OR 97411-1824

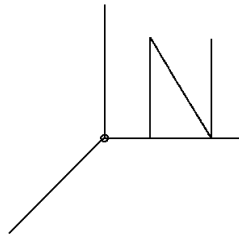

CAGE code: 1NXQ4

NARRAGANSETT SCREW MFG.,CO.

P.O. BOX 2242
119 ROWLEY ST
WINSTED, CT 06098 - 2068



CAGE code: OHP15

NASSAN TOOL WORKS, INC.

34 LAMAR ST.
WEST BABYLON, NY 11704

NTW

CAGE code: 2M490

NASU DENKI-TEKKO CO., LTD.

1-1-14 SHINJUKU, SHINJUKU-KU
TOKYO 160
JAPAN

SUNAMACHI FACTORY
3-5-28 SHINSUNA, ETO-KU,
TOKYO, JAPAN 136



CAGE code:

NATIONAL AEROSPACE FASTENERS CORPORATION (NAFCO)

NO. 5 TAI-PING E. ROAD, PINGZHEN DIST.,
TAOYUAN CITY 324, TAIWAN (R.O.C.)

Plant 1:
NO. 1, TAI-PING E. ROAD,
PINGZHEN DIST., TAOYUAN CITY
324, TAIWAN (R.O.C.)

Plant 2:
NO. 5, TAI-PING E. ROAD,
PINGZHEN DIST., TAOYUAN CITY
324, TAIWAN (R.O.C.)

Plant 3:
NO. 38, LN. 99, TAI-PING W. ROAD,
PINGZHEN DIST., TAOYUAN CITY
324, TAIWAN (R.O.C.)

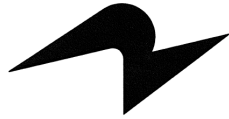

CAGE CODE: SF773

NATIONAL BOLTS & RIVETS LTD.

P.O. BOX 5063,
BOKSBURG NORTH 1461
SOUTH AFRICA



CAGE code: V3674

NATIONAL FASTENER CO., LTD.

#973 YANG DUCK-DANG
MASAN
REPUBLIC OF KOREA



CAGE code:

NATIONAL THREADED FASTENERS CORP.

630 LIVELY BOULEVARD
ELK GROVE VILLAGE, IL 60007



CAGE code:

NAVPAR, INC.

11029 STATE ROUTE 128
BLDG C-1
HARRISON, OH 45030-9710



CAGE code: 0MHC4

NC AUTOMATED INDUSTRIES INC.

90 DAYTON AVENUE
BLDG. 14E
PASSAIC, NJ 07055-7035



CAGE code: 1VPZ8

NCMI BRUEGGEMANN INC.

1207 W. BROOKS STREET
ONTARIO, CA 91762-3609

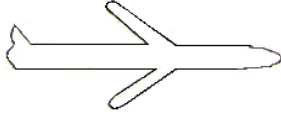

CAGE code: 0K292

ND INDUSTRIES

13929 DINARD AVENUE
SANTA FE SPRINGS, CA 90670



CAGE code: 4Y667

NEDSCHROEF HALMOND B.V.

P.O. BOX 29
5707 LC HELMOND
THE NETHERLANDS

Plant
KANAALDIJK NOORD WEST 71
5707 LC HELMOND
THE NETHERLANDS



Standard hexagon high tensile bolts and screws of all property classes



High strength friction grip bolts for structural bolting property class 10.9



Socket screws



Nuts and all other bolts and screws

CAGE code: H0871

NEKG HOLDINGS

26709 SOUTH KIMBERLY
CHANNAHON, IL 26709

NE

CAGE code: 4YU01

NELSON AEROSPACE INC.

10310 NORRIS AVE
PACOIMA, CA 91331-2219

NA

CAGE code: 52930

NELSON STUD WELDING DIVISION

7900 W. RIDGE RD
ELYRIA, OH 44036-2019

N

CAGE code: 85105

NEUMAYER, ERICH GMBH

POSTFACH 1160
WILHELM-ZANGEN-STRASSE 9
D-7613 HAUSACH
GERMANY

N

CAGE code: C1956

NEVADA BOLT AND MFG CO INC.
3850 W PONDEROSA WAY
LAS VEGAS, NV 89118

NF

CAGE code: 7U566

NEVILLE MACHINE SHOP
P.O. BOX 22
RANGER, TX 76470-2722

Plant
406 E. HIWAY 80
RANGER, TX 76470-2722

ND

CAGE code: 8X524

NEW HORIZON MACHINE CO., INC.
36 LUDLOW STREET
STAMFORD, CT 06902-2691

NH

CAGE code: 1VVZ7

NICE TOOL MFG., INC.
3280 DIANA DR.
FORT WORTH, TX 76118-6237

NT

CAGE code: 5K517

NINGBO JINDING FASTENING PIECE CO, LTD

XI JING TANG JIULONGHU ZHENHAI
NINGBO, ZHEJIANG CHINA, PRC 315205

JDF

CAGE CODE:

NIPPON MACHINE ENGINEERING, INC.
1311 EAST SAINT GERTRUDE PLACE
UNIT B
SANTA ANA, CA 92705

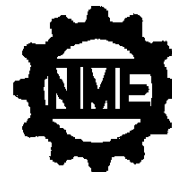

CAGE code: 49145

NIPPON STEEL BOLTEN CO., LTD.

4-3-2 NISHIZUMI, YUKUHASHI,
FUKUOKA, JAPAN 824



CAGE code:

NISCO, INC.

5F SHINGA BLDG. 1-3-10
UMEBAYASHI OUTSU-SHI
SHOGA-KEN 520, JAPAN

Plant
1018-1 ROKUJO CHUZU-CHO
YASU-GUM SHIGA-KEN
520-24 JAPAN



CAGE code:

NISSAN SCREW CO. LTD.

SALES DEPT., FOREIGN TRADE SECTION
5-6-508 SHINKANAOKA-CHO
SAKAI-SHI-OASAKA 590 JAPAN

Plant
8-4-41 MIYAKE-NAKA
MATSUBARA-SHI, OSAKA 580
JAPAN



CAGE code:

NOCHIA STEELWORKS

NYOGO, JAPAN

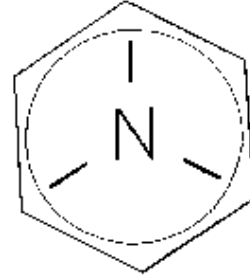

CAGE code:

NON-FERROUS BOLT & MANUFACTURING CO.

4086 NEVSO DRIVE, SUITE C
LAS VEGAS, NV 89103

Plant
3850 WEST PONDEROSA LANE
LAS VEGAS, NV 89118



CAGE code:

NORTHBRIDGE FASTENERS

VIKING ROAD
WIGSTON, LEICESTER
UNITED KINGDOM

NO LONGER IN BUSINESS

see LINREAD NORTHBRIDGE

NB



E – The plain letter E is used for Rolls Royce. UK supply and Europe and will be used in the absence of any customer allocated identification.



32219 – Allocated by Pratt & Whitney, East Hartford for supply to Pratt & Whitney, East Hartford



15077 – Allocated by Pratt & Whitney, Canada for supply to Pratt & Whitney, Canada



5T572 – Milscap No. for items supplied to U.S. Government



20733 – Allocated by Avco-Lycoming for supply to Avco-Lycoming



NTF99 – Allocated by General Electric for supply to Rolls Royce for joint projects with General Electric

CAGE code: U6683

NORTH EAST FASTENERS

8 TREMCO DRIVE
P. O. BOX 322
TERRYVILLE, CT 06786-0322



2 dots
either indented or raised.

CAGE code: 07ZN5

NORTHEAST METAL CO., INC.

P.O. BOX 51754
34 FRONT STREET
INDIAN ORCHARD, MA 01151

Plant
AIRPORT DRIVE
WESTFIELD, MA 01085



CAGE code: 1C4F2

NORTHERN SCREW CO., INC.

8121 LAKEVIEW PARKWAY
PLEASANT PRAIRIE, WI 53158

NS

CAGE code:

NORTHSTAR ENGINEERING

1911 LYNX PLACE
ONTARIO, CA 91761

0XK38

CAGE code: 0XK38

NOVA MACHINE PRODUCTS, INC.

18001 SHELDON ROAD
CLEVELAND, OH 44130-2465



CAGE code: 1EJ29

NSK INDUSTRIES, INC.

150 ASCOT PARKWAY
CUYAHOGA FALLS, OH 44223



CAGE code:

NT ENGINEERING, INC.

1050 "C" INDEPENDENCE AVE.
MOUNTAIN VIEW, CA 94043



CAGE code: 0BEN1

NUCOR CORP.

NUCOR FASTENER DIVISION
P.O. BOX 6100,
6730 COUNTY ROAD
ST. JOE, IN 46785



CAGE code: 0BEP9

NUMERIC MACHINE PRODUCTS

1769 WEST AVE. K-11
LANCASTER, CA 93534



CAGE code: 5V524

NUTS INCORPORATED

DIVISION OF STANLOK
1451 GRAFTON ST
P.O. BOX 2735
WORCHESTER, MASSACHUSETTS 01613



CAGE code: 02972

NUTS, INC.

ROUTE 724 & 23
PHOENIXVILLE, PA 19460-1838



CAGE code: 6N185

NYLOK FASTENER CORPORATION

15260 HALLMARK CT.
MACOMB, MI 48042



Blue nylon locking element



Blue nylon locking element



Blue nylon locking element



Blue nylon locking element



Blue nylon locking element



Blue nylon locking element

NK

NK

NYLOK

CAGE code: 59093

OAKTREE FASTENERS CO.

12262 1/2 WOODRUFF AVE.
DOWNEY, CA 90241

OTF

CAGE code:

OBARS MACHINE & TOOL CO.

115-126 N. WESTWOOD AVE.
TOLEDO, OH 43607

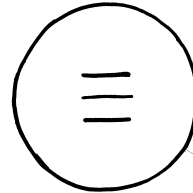

CAGE code: 0MKX0

OCM MACHINE COMPANY, INC.

9601 HIGHWAY 80
FORT WORTH, TX 76116 - 2689



CAGE code: 06XQ6

**OHIO NUT & BOLT CO., THE
DIV. OF FASTENERS INDUSTRIES, INC.**

33 LOU GROZA BLVD..
BEREA, OH 44017-1293



Small raised mark usually
on the underside of head

CAGE code: 76871

OHKAWA SCREW MFG. CO., LTD.

2-25-16 MIDORIGAOKA,
MEGURO-KU, TOKYO
152 JAPAN

Plant
6357-1 OBA, OHMIYA-MACHI,
NAKA-GUN, LBARAGI-KEU
319-21 JAPAN

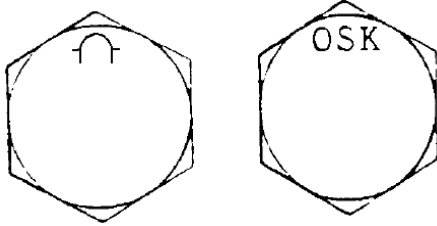

CAGE code:

OKABE CO., INC.

4-21-15 MUKOJIMA
SUMIDA-KU, JAPAN 131-8505

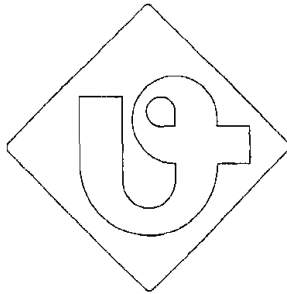

CAGE code: SP186

OKAI IRON WORKS, INC.

12-41, 3 CHOME, TSURUHARA
IZUMISANO CITY
OSAKA, JAPAN 598

OK

CAGE code:

OKAWA SCREW MANUFACTURING CO., LTD

2-20-4 HIGASHIGOTANDA
SHINAGAWA-KU, 141-0022
TOKYO

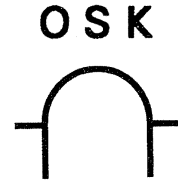

CAGE code:

OMEGA THREAD ROLLING AND GRINDING INC.

54 LEWIS STREET
P.O. BOX 129
PLAINVILLE, CT 06062-0129



CAGE code: 06KW4

ONDRIVES. US CORP

216 N MAIN ST, BLDG B-2
FREEPORT, NY 11520

RNO RNO

CAGE code: 3BPP5

ONEIDA TOOL & MACHINE CORP.

837 AIR PARK RD.
RHINELANDER, WI 54501-8426

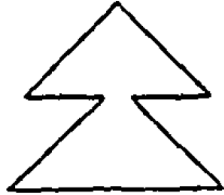

CAGE code: 0JHA0

ONO MANUFACTURER, INC.

602 FUJITA OKAYAMA-SHI,
OKAYAMA-KEN 701-0221
JAPAN

Plant
3-800-46 TAMAHARA TAMANO-
SHI, OKAYAMA-KEN 706-2555
JAPAN



CAGE code:

**ONTIC ENGINEERING &
MANUFACTURING, INC.**

20360 PLUMMER ST.
NORTH HOLLYWOOD, CA 91609-0510

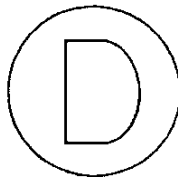

CAGE code: 45934

ORANGE PRECISION PARTS

17632 METZLER LANE, #C
HUNTINGTON BEACH, CA 92647

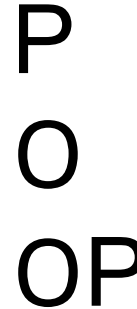

CAGE code: 9V210

ORC PRODUCTS INC.

683 BAIN STREET
SPRINGDALE, AR 72764



CAGE code: 6ENG8

ORC-O TOOL & MACHINE, INC.

75 SHAMROCK DRIVE
SULLIVAN, MO 63080-2344



CAGE code: 0C1D0

ORDNANCE PARTS & ENGINEERING CO.

P.O. BOX 8035
3152 C MAJOR ST
FORT WORTH, TX 76112



CAGE code: 20800

ORLOTRONICS CORP.

401 E. FOURTH STREET
BRIDGEPORT, PA 19405-1815



CAGE code: 54267

OSAKA SEIKI CO., LTD.

1-19-14, MITEJIMA
TOKYO 555
JAPAN

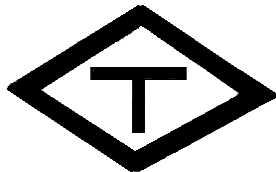

CAGE code: S4247

OSTEEN MACHINE SHOP

RT. 1 BOX 2082
ALVARADO, TX 76009



CAGE code: 8Y546

OTO MELARA S.p.A.

FINKECCANICA COMPANY
VIA VALDILOCCHI 15
LA SPEZIA 19136
ITALY



CAGE code: A0199

OTT BROTHERS MACHINE CO., INC.

331 EAST 37TH STREET SOUTH
WICHITA, KS 67216



CAGE code: 09292

OTTAWA PRODUCTS CO., INC.

1602 NORTH CURTICE RD.
CURTICE, OH 43412



CAGE code: 4JBK8

OWARI PRECISE PRODUCTS CO., LTD

2-148 YADA-CHO HIGASHI-KU NAGOYA-SHI
AICHI-KEN, JAPAN

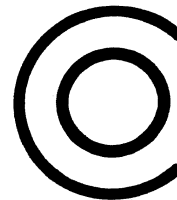

CAGE code: SC008

P & I ASSOCIATES, INC.
26 WEST WAVERLY ROAD
P.O. BOX 413
GLENSIDE, PA 19038-4012

Plant
#1 LIMEKILN PIKE
GLENSIDE, PA 19038
(No mail to this address)



CAGE code: 0DH98

P & L ENTERPRISES
111 CR 4614
CASTROVILLE, TX 78009

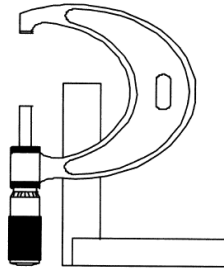

CAGE code: 058B7

P.C.M., INC.
BETHLEHEM PIKE INDUSTRIAL CENTER
P.O. BOX 840
60 PARRISH ST.
WILKES BARRE, PA 18710



CAGE code:

P.S. MACHINE CO., INC.
1505 JOHN FETCH BLVD.
S. WINDSOR, CT 06074-1000

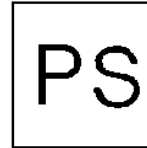

CAGE code: 56839

PABCOR, INC.
925 NORTH CEDAR STREET
P.O. BOX 7528
NEW CASTLE, PA 16107-1323



CAGE code: OAGN7

PACER ALLOYS, INC.
8681 SCRANTON STREET
HOUSTON, TX 77075

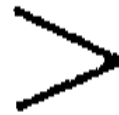

CAGE code:

PACIFIC FASTENERS, INC.
405 UNIVERSITY AVENUE
ARLINGTON HEIGHTS, IL 60004

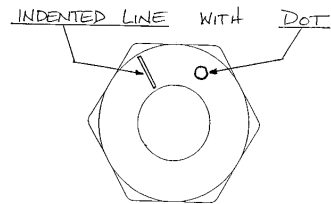

CAGE code: 42918

PACIFIC SCIENTIFIC
22715 SAVI RANCH PARKWAY
P.O. BOX 87019
YORBA LINDA, CA 92686

PS

CAGE code: 45402

PACIFIC TOOL, INC.
15235 NE 92ND STREET
REDMOND, WA 98052

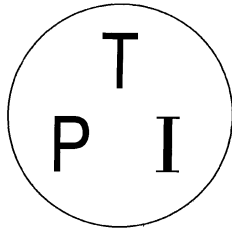

CAGE code: 62176

PADGETT MACHINE INC.
1226 NORTH 143rd EAST AVENUE
TULSA, OK 74116-2120

PMI

CAGE code: 6W037

PAINTER TOOL, INC.
1173 IRIS DRIVE
NORTH HUNTINGDON, PA 15642-4399

PTI

CAGE code: 34779

PALNUT CO.
UNITED CARR FASTENERS PALNUT DIV
GLEN ROAD
MOUNTAINSIDE, NJ 07092

PAL

CAGE code: 2G832

PANTHER MACHINING AND HARDWARE
10303 E. BANKHEAD HWY SUITE 103B
ALEDO, TX 76008

PMH

CAGE code: 71G41

PAOLO ASTORI SPA
VIA MIRABELLA 9 – 28013
NOVARA, ITALY



CAGE code: A3856

PARK PRECISION CORPORATION
181 ELLIOT ST. UNIT 403
BEVERLY, MA 01915

-PPC-

CAGE code: OJWS2

PARKER FASTENERS, LLC

13765 W. AUTO DR., SUITE 122
GOODYEAR, AZ 85338



CAGE code: 6YKZ1

PATEREX, LTD.

CRAY AVE.
ORPINGTON KENT BR5 3RR
UNITED KINGDOM



CAGE code: 0BMF6

PATRIOT MANUFACTURING

P.O. BOX 967
BELLEVILLE, MI 48112

Plant
45345 FIVE MILE ROAD
PLYMOUTH, MI 48170



CAGE code: 7ESS3

PATTERSON LAKE PRODUCTS

P.O. BOX 200
PINCKNEY, MI 48169



CAGE code: 5Y952

PAULIN, H. & CO., LTD.

CAPITAL METAL INDUSTRIES DIVISION
55 MILNE AVENUE
SCARBOROUGH, ONTARIO MIL 4N3
CANADA



CAGE code: 95119

PB FASTENERS

1700 WEST 132ND STREET
GARDENA, CA 90249

MFR 27624



PBF

PB

CAGE code: 27624

PEAR, INC.

1615 NORTHWOOD DR.
ST AUGUSTINE, FL 32084

Pear

CAGE code: 84LV3

PECO AEROSPACE FASTENERS

4707 SE 17th AVENUE
PORTLAND, OR 97202
plant
361 S. SEQUOIA PRKWY
CANBY, OR 97013

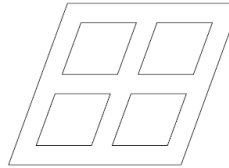

35° Rhombus with 4 smaller Rhombuses
equally spaced, one in each quadrant of
the larger Rhombus

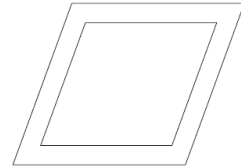

35° Rhombus with 4 smaller Rhombuses
removed (design is for smaller size
fasteners)

CAGE code:

PEERLESS SCREW PRODUCTS

286 SANDBANK RD.
P.O. BOX 236
CHESIRE, CT 06410-1537



CAGE code: 45950

PEINER UMFORMTECHNIK GmbH

WOLTORFER STRASSE 26
PEINE, 31224
GERMANY

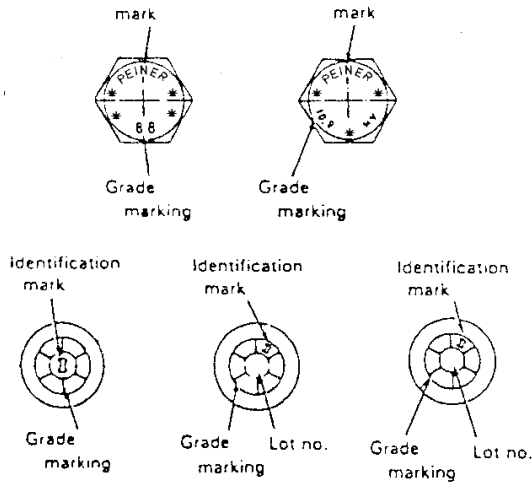

CAGE code: D2742

PELHAM AUTO MATRIX PRECISION

1 INDUSTRIAL DRIVE
PELHAM, NH 03076



CAGE code: 1CSJ5

PENN CIGAR MACHINES INC

P. O. BOX 1065
60 PARRISH STREET
WILKES BARRE, PA 18703



CAGE code: 7U218

PENN ENGINEERING & MANUFACTURING CORP.

5190 OLD EASTON RD.
DANBORO, PA 18916

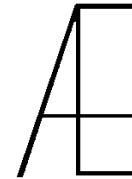

Square insert in floating fasteners

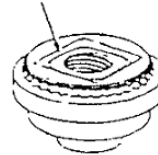

"Dimple" trademark



PEM trademark
Blue - nylon® hexagon locking element

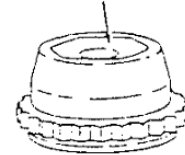

PEM 300™ identification mark

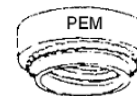
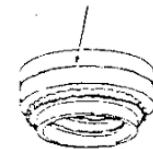

CAGE code: 46384

MIL-HDBK-57J (GS7)
APPENDIX A

PENN ENGINEERING & MANUFACTURING CORP.

2400 LOWERY STREET
WINSTON-SALEM, NC 27101

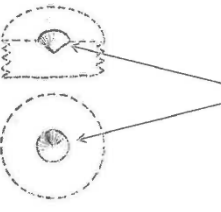
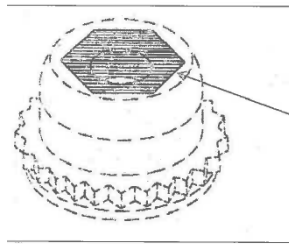
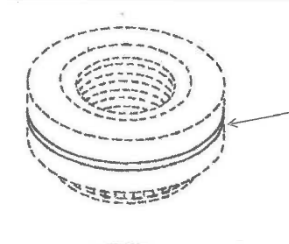
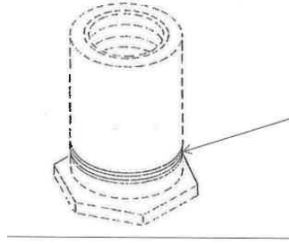
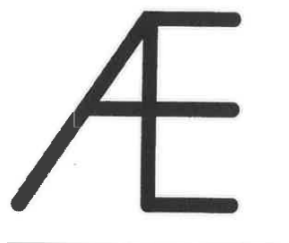
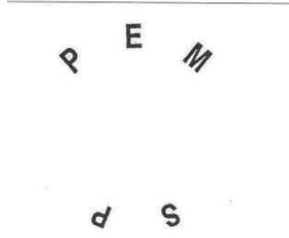
	<p>PEM Dimple (Registered Trademark)</p>
	<p>PEM Blue Nylon Locking Element (Registered Trademark)</p>
	<p>PEM Single Groove (Registered Trademark)</p>
	<p>PEM Two Groove (Registered Trademark)</p>
	<p>ATLAS AE Stamp (Registered Trademark)</p>
	<p>PEM Stamp (Registered Trademark)</p>

(Continued)

(Continued)

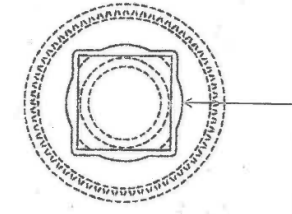
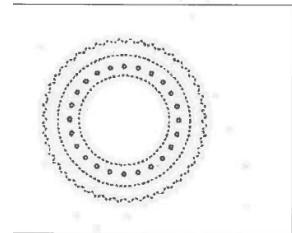
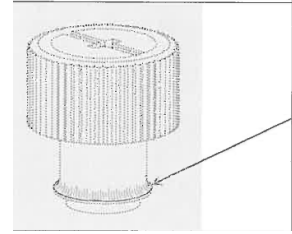
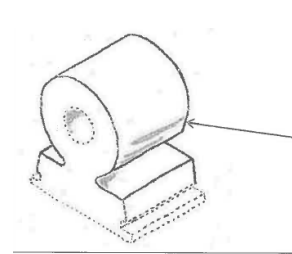
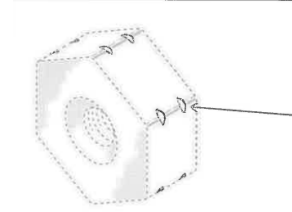
	<p>PEM Double Squares (Registered Trademark)</p>
	<p>PEM C.A.P.S Dot Pattern (Registered Trademark)</p>
	<p>PEM Skirted Shoulder (Registered Trademark)</p>
	<p>PEM Circle on Pedestal (Registered Trademark)</p>
	<p>PEM Double Notch (Registered Trademark)</p>

CAGE code: 56C13

PENN SCREW & MACHINE WORKS, INC.

3075 ADVANCE LN.
COLMAR, PA 18915



CAGE code: 82926

**PENNEENGINEERING AUTOMOTIVE
FASTENERS**

50625 DESIGN LANE
SHELBY TOWNSHIP, MI 48315



CAGE code: 50EB1

PEREZ MACHINE, INC.

1501 W. 134TH STREET
GARDENA, CA 90249



CAGE code: 34393

**PERIGEE MANUFACTURING COMPANY,
INC.**

7519 INTERVALE
DETROIT, MI 48238-2401

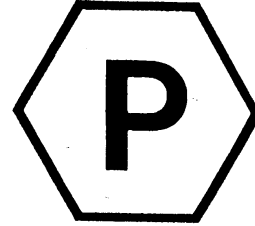

CAGE code: 1X4X7

PERKINS MACHINE CO.

1559 PINE STREET
OXNARD, CA 93030



CAGE code: 84749

**PHOENIX SPECIALTY MANUFACTURING
CO., INC.**

P.O. BOX 418
BAMBERG, SC 29003

Plant
HIGHWAY 301 SOUTH
BAMBERG, SC 29003



CAGE code: 66920

PILGRIM SCREW CORP.

120 SPRAGUE STREET
PROVIDENCE, RI 02901

Plant
2875 WEST FRYE ROAD
CHANDLER, AZ CHANDLER, AZ
CAGE code: 1GP79

AD

π

CAGE code: 47253, 1GP79

PINE TAVERN MACHINE INC.

7851 PINE TAVERN ROAD
PERRY, NY 14530

PTM

CAGE code: 9J559

PINEY RIDGE CO.

177 JOSHUA ROAD
SALUDA, SC 29138-7770

PR

CAGE code: 05DT2

PINTO PRODUCTS

P.O. BOX 83
2011 PALMER STREET
KALAMAZOO, MI 49001



CAGE code: 0YJH8

PIONEER MACHINE PRODUCTS, INC.

2200 DOLMAN
ST. LOUIS, MO 63104

PMP

CAGE code: 12829

PIONEER SCREW & NUT CO.

2700 YORK ROAD
ELK GROVE VILLAGE, IL 60007



Indented hex heads and
indented hex washer
heads



All other head styles slash-
dot symbol to appear on
bearing surface upon
request

CAGE code: 4N311

PLAINVILLE MANUFACTURING CO., INC.

48 LEWIS ST.
PLAINVILLE, CT 06062



CAGE code:

PMB PRECISION PRODUCTS INC

DBA SPARTAN INSTRUMENTS
725 MOUNT AVENUE
NORTH BABYLON, NY 11703

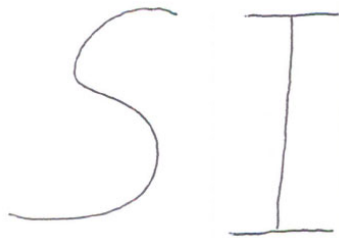

CAGE code: 747T4

PNEU-HYDRO PRODUCTS, INC.

353 RICHARD MINE ROAD
WHARTON, NJ 07885



CAGE code:

POINT MACHINE COMPANY

P.O. BOX 8055
33 CAMBRIDGE HEIGHTS
KENSINGTON, CT 06037

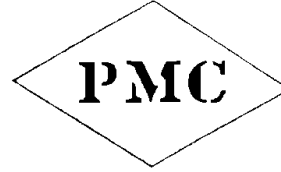

CAGE code: 9N716

POLYTECHNIC INDUSTRIES

14 ROLAND AVE.
MOUNT LAUREL, NJ 08054



CAGE code: 4K539

PORTLAND BOLT & MFG., CO.

P.O. BOX 2866
1210 NW JOHNSON ST
PORTLAND, OR 97208

Plant
3441 NW GUAM ST
PORTLAND, OR 97210-2688
CAGE code: 3QCS3



CAGE code: 3S498, 3QCS3

PORTSMOUTH NAVAL SHIPYARD

SEAVEY ISLAND
KITTERY, ME 03904



CAGE code: 81316

POSIMECH, INC.

15 INDUSTRIAL (SCOUTING) BLVD.
MEDFORD, NY 11763



CAGE code: 0AXM0

POWER GEN COMPONENTS, LLC

4311 WEST OQUENDO ROAD
LAS VEGAS, NV 89118



CAGE code: 7NJD6

POWERPARTS, INC.

P.O. BOX 38557
601 MCFARLAND STREET
HOUSTON, TEXAS 77011



CAGE code: 66297

PRD FASTENERS LTD.

UNIT 10/15 MONMER CLOSE
WILLENHALL, WV12 1JR
UNITED KINGDOM



CAGE code: U8651

PRECI-MANUFACTURING, INC.

400 WEAVER STREET
WINOOSKI, VT 05404-1391



CAGE code: 66841

PRECISE AERO PRODUCTS

4120 INDUS WAY
RIVERSIDE, CA 92503-4808



CAGE code: 00AE2

PRECISE OF CALIFORNIA

DIV OF ADJUSTABLE BUSHING CORP
8330 LANKERSHIM BLVD.
NORTH HOLLYWOOD, CA 91605



Panel fastener



Quick-acting pins

CAGE code: 62372

**PRECISION AIRCRAFT MACHINING CO.,
INC.**

10640 ELKWOOD STREET
SUN VALLEY, CA 91352

PAMCO

PAM

CAGE code: 66774

PRECISION FITTINGS, INC.

709 NORTH MAIN ST.
WELLINGTON, OH 44090

PF

CAGE code: 92192

PRECISION MACHINING COMPANY

10709 TUBE DR., STE 160
HURST, TX 76053

FB

CAGE code: 6ZF42

PRECISION METAL PRODUCTS CO.

#7 CENTENNIAL DRIVE
CENTENNIAL INDUSTRIAL PARK
PEABODY, MA 01961-6026



CAGE code: 4V472

PRECISION PARTS & TOOL CO., INC.

108 ROME STREET
FARMINGDALE, NJ 11735

L.P.R.

CAGE code:

PRECISION PIECE PARTS, INC.

712 S. LOGAN ST.
MISHAWAKA, IN 46544



CAGE code: 98072

PRECISION SCREW & BOLT, INC.

1491 CHARDON ROAD
CLEVELAND, OH 44117-1598

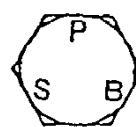

GRADE 2

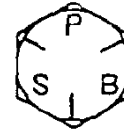

GRADE 5

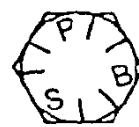

GRADE 8

CAGE code: 02BC3

PRECISION TECHNOLOGIES, INC.

1538 INDUSTRIAL AVE.
OTTAWA, KS 66067

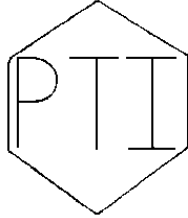

CAGE code:

PRECISION THREADED PRODUCTS, INC.

220 BUSINESS PARK ROAD
BRISTOL, CT 06010



CAGE code: 02991

PRECISIONMATICS CO., INC.

HELMER AVE.
WEST WINFIELD, NY 13491

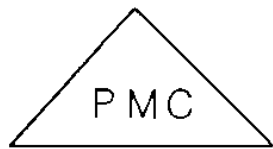

CAGE code:

PREM INDUSTRIES, INC.

P.O. BOX 907
NIAGRA FALLS, NY 14302

Plant
574-56th ST.
NIAGRA FALLS, NY 14304



CAGE code: 4Y327

PRESTIGE STAMPING, INC.

23513 GROESBECK HWY
WARREN, MI 48089



CAGE code: 0AAB6

PRICE MANUFACTURING CO.

372 NORTH SMITH AVENUE
CORONA, CA 91720

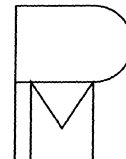

CAGE code: 1K6D8

PRIETO MACHINE COMPANY, INC.

1785 STOUT DRIVE
UNIT D
WARMINSTER, PA 18974

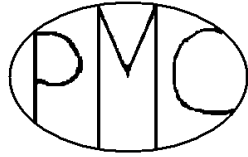

CAGE code: 8Y298

PRODUCTS DESIGN & MFG. CORP.

P.O. BOX 11429
NEWINGTON, CT 06111

Plant
76 STANWELL RD.
NEWINGTON, CT 06111

8M938

CAGE code:

PRODUCT DEVELOPMENT GROUP, INC.

P.O. BOX 177
ROSE HILLS, KS 67133



CAGE code: OMAR7

PROFORMANCE MANUFACTURING, INC.

1922 ELISE CIRCLE
CORONA, CA 92879

PMI

CAGE code: 62F29

PRODUCTION & TOOL COMPANY

240 SARGENT DRIVE
NEW HAVEN, CT 06511



CAGE code: 8N334

PRO-MACHINE & TOOL COMPANY

792 BLAKE BOTTOM RD.
HUNTSVILLE, AL 35806



CAGE code: IDS66

PROMPTUS ELECTRONIC HARDWARE

520 HOMESTEAD AVENUE
MT. VERNON, NY 10550

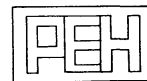

CAGE code: 57177

PROTO MACHINE CO., INC.
P.O. BOX 1240
1295 GOLDEN TRIANGLE BLVD.
KEELER, TX 76248



CAGE code: 0AWM2

PTM INTERNATIONAL INC.
8050 NW 31ST
MIAMI, FL 33122



CAGE code: 0S6M6

PURITAS METAL PRODUCTS
7720 RACE RD
NORTH RIDGEVILLE, OH 44039-3614



CAGE code: 04368

PV ENGINEERING & MFG. INC.
88 RABBIT ROAD
SALISBURY, MA 01960



CAGE code: 1X5E2

PYE & HOGAN MACHINE CO.
P. O. BOX 832
167-1 ELM ST
OLD SAYBROOK, CT 06475-4134

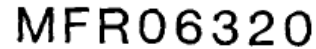

CAGE code: 06320

QRP, INC.
P.O. BOX 832
2307 MERCANTILE DR NE
LELAND, NC 28451-4065



CAGE code: 09094

QSN MANUFACTURING, INC.
201 FRONTIER WAY
BENSENVILLE, IL 60106

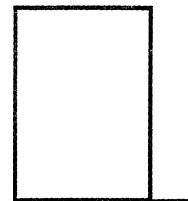

CAGE code: 0MDU6

QUALITY AIRCRAFT SCREWS, INC.
1030-A ORTEGE WAY
PLACENTIA, CA 92670



CAGE code:

QUALITY BOLT & SCREW CO.

10147 BRECKSVILLE RD.
BRECKSVILLE, OH 44141-3205

Division of ELGIN FASTENER GROUP LLC

QB

CAGE code: 0BCN3

QUALITY FABRICATIONS, INC.

3270 WROLSEN DRIVE
SAUGERTIES, NY 12477



CAGE code: IJB77

QUALITY MACHINE & MFG INC.

1316 BLACK VALLEY ROAD
LAFOLLETTE, TN 37766



CAGE code: 1DB71

QUALITY MACHINE SERVICES LLC

350 GRIFFIN RD
YOUNGSVILLE, LA 70592

QMS

CAGE code: 4MWQ4

QUALITY SCREW PRODUCTS, INC.

P.O. BOX 2355
35101 SCHOOLCRAFT ROAD
LIVONIA, MI 48151

Q

CAGE code: 4F051

**QUALITY SOCKET SCREW
MANUFACTURING CORP.**

2790 NORTH AVE.
ENGLEWOOD, IL 34224

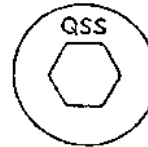

Socket head cap screw head
marked for I.D. QSS

CAGE code: 5N116

**QUALITY THREADED PRODUCTS
COMPANY**

4734 HIGHWAY 157 N.
JUDSONIA, ARKANSAS 72081

QT

CAGE code: 0RXV6

R & D FASTENERS

P. O. BOX 250
9604 7TH ST
RANCHO CUCAMONGA , CA 91730



CAGE code: 05BE3

R & D WELDING & MACHINE INC.

1200 GEORGIA AVE.
WARNER ROBBINS, GA 31093

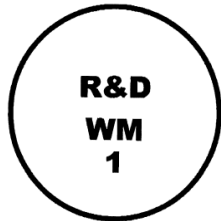

CAGE code: 1H3J7

R & I ENTERPRISES

DBA COMPULOGIC DESIGN CO.
233 PAREDES LINE RD.
BROWNSVILLE, TX 78521



CAGE code: 1CHU5

R & R PRECISION

604 S. 9TH ST.
GUNNISON, CO 81230



CAGE code: 0GKX6

R B & W CORPORATION

5190 BRADCO BLVD.
TORONTO, ONTARIO
CANADA

Plant
DELAWARE CORPORATION
8341 TYLER BLVD
MENTOR, OH 44060

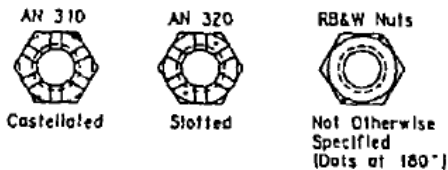
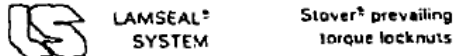
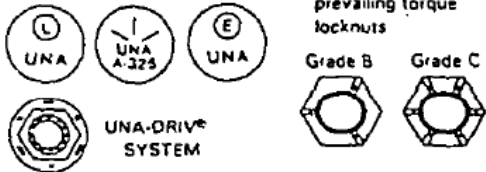
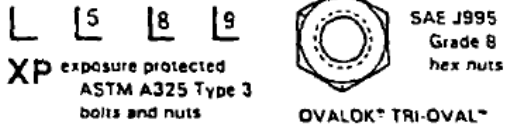
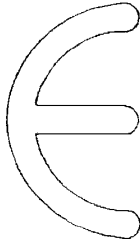

CAGE code: 52167

(Continued)

(Continued)

R B & W CORPORATION

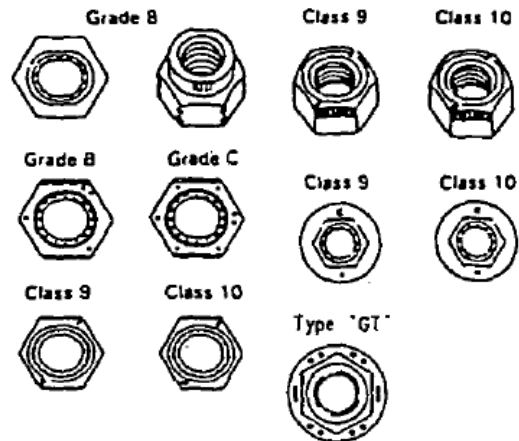
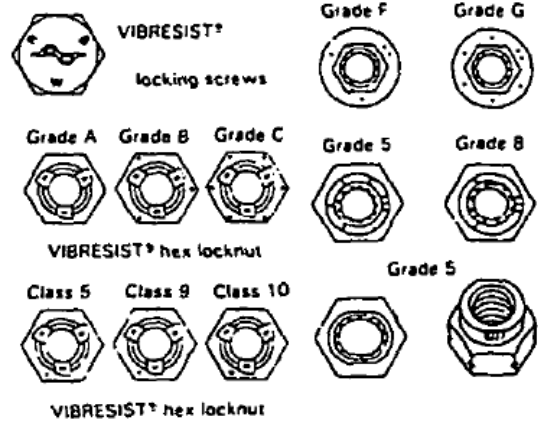

CAGE code: 52167

R. BILD COMPANY, INC.

15205 STAGG STREET
VAN NUYS, CA 91405-1003



CAGE code: 04QM7

R.E.C. CORP.
10 BEACH ST.
MOUNT VERNON, NY 10550

R

Used on all alloy and stainless steel bolts, studs, and nuts over 1/2 inch in diameter.

CAGE code: 86687

RABOURDIN
ZI R DES MARAIS
P.O. BOX BP 157
ST. JUST EN CHAUSSEE,
FRANCE 60130

GR

CAGE code: F4870

RADAX INDUSTRIES, INC.
700 BASKET ROAD
WEBSTER, NY 14580

RX

CAGE code: 6V794

RAE MANUFACTURING CO.
1327-1331 CEDAR STREET
PORT HURON, MI 48060-6167

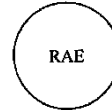
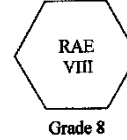
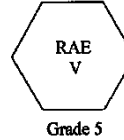
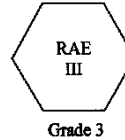

CAGE code: 3FDT8

RAGHU VAMSI MACHINE TOOLS PVT LTD
PLOT No. 60/A
IDA GANDHI NAGAR, HYDERABAD
TELANGANA 500037, INDIA

Plant
SHED No. 2 PLOT No. 26 B
HARDWARE PARK, KANCHA
IMARATH RAVIRYALA VILLAGE
RANGAREDDY, TELANGANA
500005, INDIA
Cage code 1274Y

RV

CAGE code

RAHMEDE SCHRAUBENFABRIK
WEFELSHOHLER STR 44
D-5880 LUDENSCHIED
GERMANY

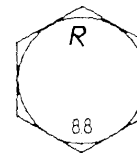

CAGE code: D9901

RAINBOW MACHINE PRODUCTS, INC.

P.O. BOX 1906
226 WILLIS ROAD
YORK, PA 17405



CAGE code: 9S535

RAM ENTERPRISES

1382 CORONADO ST
LONG BEACH, CA 90804



CAGE code: OU3C8

RAM PRODUCTS

AFS TORRANCE OPERATIONS
3016 WEST LOMITA BLVD.
TORRANCE, CA 90505-5103

NO LONGER IN BUSINESS

see ARCONIC FASTENING SYSTEMS &
RINGS



CAGE code: 0CBU7

RAM THREADING, INC.

P.O. BOX 987
BEAUMONT, TEXAS 77704

Plant
2640 CROCKETT
BEAUMONT, TX 77701



Centered over grade of material being stamped

CAGE code: 1Y826

RAMAR NUTS, INC.

18401 WEAVER ST.
DETROIT, MI 48228



CAGE code: 4L633

RAMCO SPECIALTIES, INC.

5369 HUDSON DRIVE
HUDSON, OH 44236

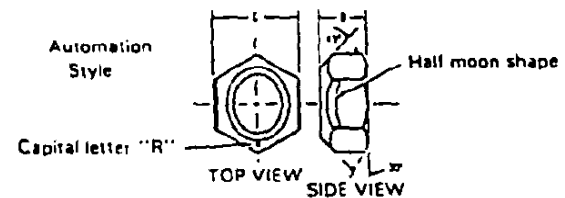

CAGE code: 6U460

RAMM DEFENSE PRODUCTS

3161 D MAJOR ST
FORT WORTH, TX 76112-7270



CAGE code: 0BRC1

**RATHMANN WALTER G. SEGMENT-
KLAMMERSCHRAUBEN GMBH**

ALTE EMSER STRASSE 32
KOBLENZ, 56077
GERMANY



CAGE code: C6486

RA-WHITE, INC

967 WEST HYDE PARK BOULEVARD
INGLEWOOD, CA 90302



CAGE code: 5Y319

RB & W CORP.

23001 EUCLID AVE.
CLEVELAND, OH 44117

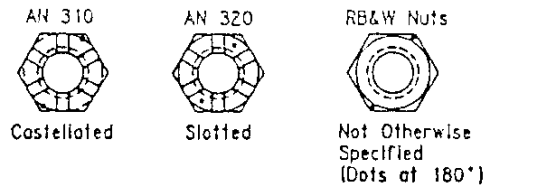
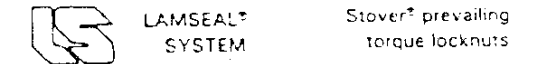
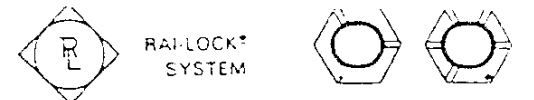
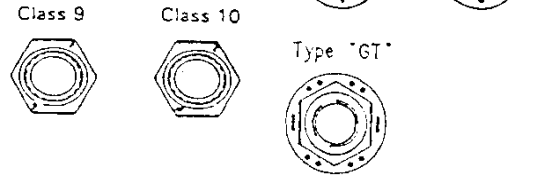
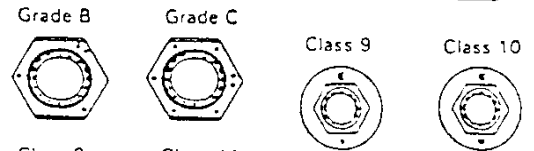
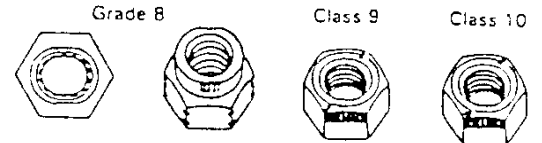
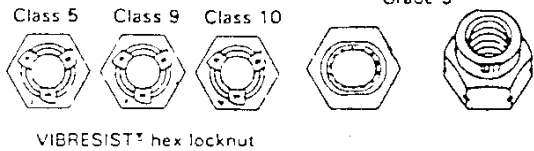
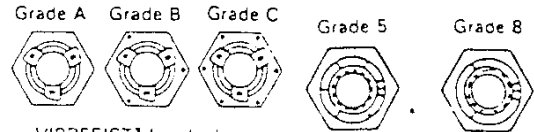
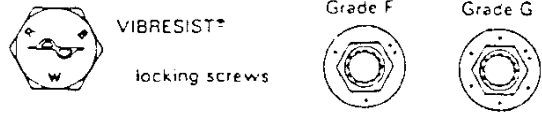

CAGE code: 0VZJ0

REED INSTRUMENT CO.

1525 BLALOCK ROAD
HOUSTON, TX 77080



CAGE code: 3B132

RELIANT FASTENER

201 E. 2ND STREET
ROCK FALLS, IL 61071

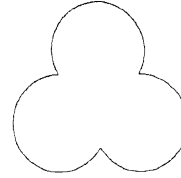

CAGE code:

REGAL AIR, INC.

P.O. BOX 1011
108 E. ALABAMA
MT. PLEASANT, TX 75455

4J976

CAGE code: 4J976

RELLI TECHNOLOGY, INC.

1200 SOUTH ROGERS CIRCLE
BOCA RATON, FL 33487



Raised or depressed character

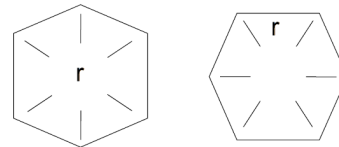

CAGE CODE: 57550

REID PRODUCT INC.

21430 WAALEW RD
APPLE VALLEY, CA 92307

Rp

9R

R9

CAGE code: 59563

REPUBLIC FASTENER MANUFACTURING CORP.

1300 RANCHO CONEJO BOULEVARD
NEWBURY PARK, CA 91320-1405

NO LONGER IN BUSINESS

see ARCONIC FASTENING SYSTEMS &
RINGS



CAGE code: 52828, 71087

REXNORD INC.

SPECIALITY FASTENERS DIVISION
3000 WEST LOMITA BLVD
TORRANCE, CA 90505

NO LONGER IN BUSINESS

see ARCONIC FASTENING SYSTEMS &
RINGS

TRIDAIR PRODUCTS
3000 WEST LOMITA BLVD.
TORRANCE, CA 90505

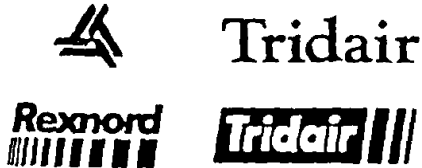

CAMLOC PRODUCTS
601 ROUTE 46 WEST
HASBROUCK HEIGHTS, NJ 07604

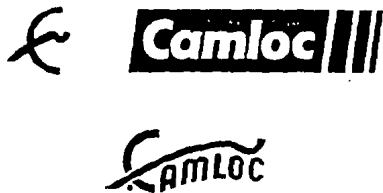

ROSAN PRODUCTS
3130 W. HARVARD ST.
SANTA ANA, CA 92704

RI

CAGE code: 76017

RHIMCO INDUSTRIES, INC.

4150 BRITTON ROAD
MANSFIELD, TX 76063

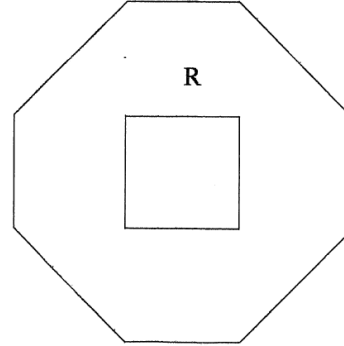

CAGE code: 57094

RICHARD MANNO & CO., INC.

42 LAMAR ST
WEST BABYLON, NY 11704

R/M

CAGE code: 0RGV4 & 3BFK5

RICHARD MFG. CO., INC.

250 ROCK LANE
MILFORD, CT 06460-3853



CAGE code: 4A014

RINCO TECHNOLOGIES, INC.

10275 PHILADELPHIA CT.
RANCHO CUCAMONGA, CA 91730



CAGE code: 4NG33

RING SCREW WORKS

10160 GAINEY RD
HOLLY, MI 48442 - 9331

FENTON HEADING

2480 OWEN RD.
FENTON, MI 48430-1769
CAGE code: 7M992



FERNDALE FASTENER

31600 STEPHENSON HIGHWAY
MADISON HEIGHTS, MI 48071



RING SCREW DIVISION

22100 SHERWOOD AVE.
WARREN, MI 48091



SEMCO FASTENER

4146 EAST BALDWIN RD.
HOLLY, MI 48442



TITAN FASTENER

10031 HOLLY RD.
HOLLY, MI 48442



CAGE code: 0B2C8

RIPA ENGINEERING CORP.

9555 OWENSMOUTH AVE.
UNIT # 7 & 8
CHATSWORTH, CA 91311

RIPA

CAGE code: 3R930

RIPPA PRODUCTS

P.O. BOX 328
5 MILE POINT RD
MOHAWK, MI 49950

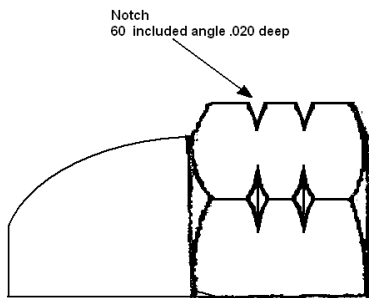

CAGE code: 0R7Z5

RISCO, INCORPORATED

390 RISCO CIRCLE
BEAUMONT, CA 92223-2676

01DC

CAGE code: 6W027

RIVER VALLEY TOOL & MANUFACTURING

P. O. BOX 64
260 AIRPORT INDUSTRIAL ROAD
PARIS, AR 72855

RVT

CAGE code: 3K1M6

RIVNUT ENGINEERED PRODUCTS, INC.

2705 MARION DRIVE
KENDALLVILLE, IN 46755

REP

CAGE code: 0VK23

RMS

1125 W ACACIA AVE
HEMET, CA 92543

R M S

CAGE code:

ROBBINS MANUFACTURING

P.O. BOX 704
1200 AIRPORT ROAD
FALL RIVER, MA 02722



CAGE code: 8T312

ROBERT HENRY CO., INC.

87 OPAL STREET
MILFORD, CT 06460

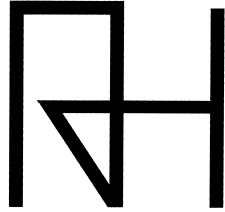

CAGE code: 9J112

ROCKFORD BOLT & STEEL CO.

126 MILL ST
ROCKFORD, IL 61101-1491

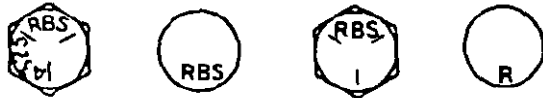

CAGE code: 90483

ROCKFORD FASTENERS INC.

P.O. BOX 884
ROCKFORD, IL 61105

Plant
725 SOUTH STREET
ROCKFORD, IL 61102



CAGE code: 0B998

ROCKFORD PRODUCTS CORP.

707 HARRISON AVE
ROCKFORD, IL 61108

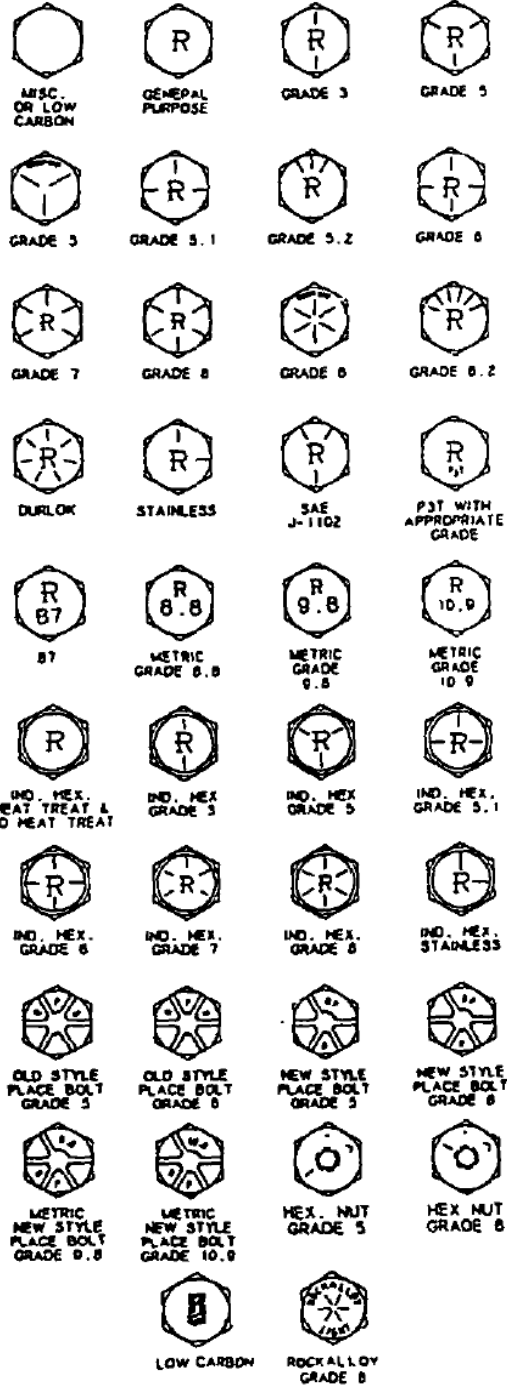

CAGE code: 77595

ROGG MANUFACTURING COMPANY

600 DANBURY ROAD
NEW MILFORD, CT 06776

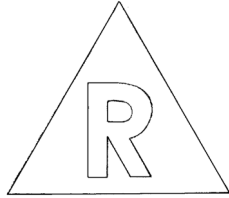

CAGE code: 08625

ROSAN PRODUCTS

3018 WEST LOMITA BLVD.
TORRANCE, CA 90505-5103

NO LONGER IN BUSINESS

see REXNORD INC.



CAGE code: 83324

ROLAND AEROSPACE

13429 SOUTH WESTERN AVENUE
UNIT G
GARDENA, CA 90249



CAGE code: 63EM5

ROTAIR INDUSTRIES, INC.

P.O. BOX 4098
964 CRESCENT AVE
BRIDGEPORT, CT 06607-1025



Rubber stamped
on fasteners

54878

Commercial and Government Entity
(CAGE) number affixed or rubber

CAGE code: 54878

ROMAC ELECTRONICS, INC.

155 E. AMES CT.
PLAINVIEW, NY 11803

8T968

CAGE code: 8T968

RS MANUFACTURING, INC.

INDUSTRIAL PARK BLVD.
MENTOR, OH 44060

RS



CAGE code: 0MYK3

RONSON MANUFACTURING, INC.

9933 CHILLICOCTHE ROAD
KIRKLAND, OH 44094

R

CAGE code: 2X146

RUDOLPH INSTRUMENTS, INC.

400 MORRIS AVE STE 120
DENVER, NJ 07834-1362

RI

CAGE code: 23262

RUDOLPH PRECISION PRODUCTS

50 NEW STREET
WAYNE, NJ 07470

Plant
50 S CENTER STREET, UNIT 8
ORANGE, NJ 07050

RP

CAGE code: 4AD23

RUMCO, INC.

985 PAULY DR.
ELK GROVE VILLAGE, IL 60007-1312

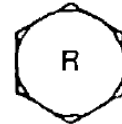

GRADE 2



GRADE 5

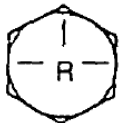

GRADE 5.1

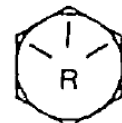

GRADE 5.2



GRADE 8

CAGE code: 6Z992

RUSCOMB TOOL & MACHNE CO., INC.

500 W. RUSCOMB STREET
PHILADELPHIA, PA 19120



RTM

CAGE code: 07952

S & L FASTENERS, LLC
3275 MEETINGHOUSE RD.
TELFORD, PA 18969

SL

CAGE code:

S. B. E. (ITALY CORPORATION)
VIA ENRICO DERMI
20019 SETTIMO
MILANESE, ITALY

SBE

CAGE code:

S & L METAL PRODUCTS CORP.
5829 57TH DR
MASPETH, NY 11378-2232

S&L

CAGE code: 05722

S.A.B.A. S.p.A. BULLONERIA E. AFFINI
VIA LIGURIA 11/13,
20098 SESTO ULERIANO
FRAZ. DI S. GUILLANO M.SE
MILANO, ITALY

A.L.

CAGE code:

S & L TOOL
36080 INDUSTRIAL ROAD
LIVONIA, MI 48150

SL

CAGE code: 5C304

S.I. STUD, INC.
1127 SILBER RD.
HOUSTON, TX 77055

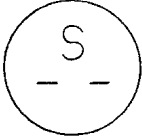

CAGE code:

SABRE MANUFACTURING, INC.

P.O. BOX 11386
201 S. CHERRY ST.
SOUTH BEND, IN 46601

S

CAGE code: 0GN74

SAFETY SOCKET LLC.

6501 N. AVONDALE AVENUE
CHICAGO, IL 60631

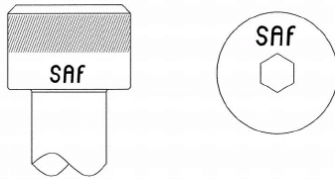

CAGE code: 82896

SAFETY SOCKET SCREW CORP.

6501 NORTH AVONDALE AVE.
CHICAGO, IL 60631

INCH SOCKET HEAD CAP SCREWS

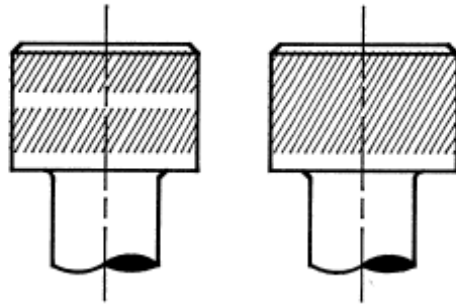

BUTTON HEAD CAP SCREWS

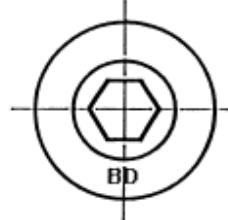

FLAT HEAD CAP SCREWS AND SOCKET HEAD SHOULDER SCREWS

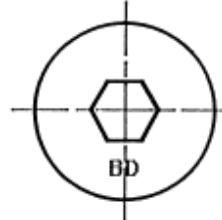

METRIC SOCKET HEAD CAP SCREWS

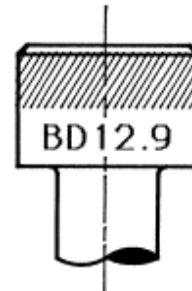

BD AND THE 60° DIAGONAL KNURL ARE REGISTERED TRADEMARKS OF SAFETY SOCKET SCREW CORPORATION FOR THE PURPOSE OF MANUFACTURERS IDENTIFICATION

BD BDM

CAGE code: 82896

SAGA TEKKOSHO CO., LTD.

129-3 TAKAYA
FUJISAWA-CITY KANAGAWA PREF.,
JAPAN



CAGE code:

SAMUEL MARSDEN & SON

WELLINGTON RD.
ASHTON UNDER LYNE,
LANCASHIRE OL6 7EG
UNITED KINGDOM



CAGE code:

SAI INDUSTRIES CORP.

1207 FULTON AVENUE
SAN ANTONIO, TX 78201-4501

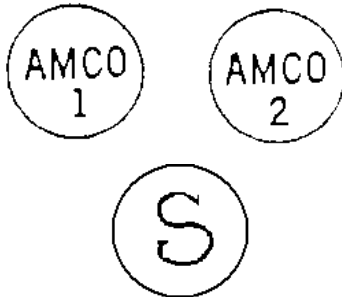

CAGE code: 1KQ10, 63095

SANDIK MANUFACTURING, INC.

100 8TH STREET
PASSAIC, NJ 07055



CAGE code: 6U704

SALEM MANUFACTURING AND SALES, INC.

2856 BANWICK RD.
COLUMBUS, OH 43232



CAGE code: 57140

SANNOHASHI SEISAKUSHO CO., LTD.

2-1-18 OKINO ADACHI-KU
TOKYO 123
JAPAN

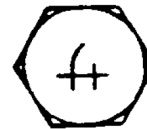

CAGE code:

SALES SYSTEM, LIMITED

P.O. BOX 7006
700 FLORIDA AVE.
PORTSMOUTH, VA 23707-1918



CAGE code: 8F411

SANTA ANA GEAR & MACHINE

15201 PIPELINE LN.
HUNTINGTON BEACH, CA 92649



CAGE code:

SANTA ANA SCREW PRODUCTS INC.
SANTA ANA, CA 92701



CAGE code: 33644

SATAIR MANUFACTURING FACILITY
PURDEYS WAY
PURDEYS INDUSTRIAL ESTATE
ROCHFORD, ESSEX, SS5 4JJ
UNITED KINGDOM

SMF

CAGE code: K4975

SATURN FASTENERS, INC.
425 SOUTH VARNEY ST.
BURBANK, CA 91502-2125

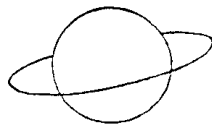

CAGE code: 0K6Z0

SCANDIA MFG. CO., INC.
480 BRUNSWICK ST.
BALTIMORE, MD 21223-2745

SCA

CAGE code: 00997

SCHMICO GMBH SCHWEISSTECHNIK
P. O. BOX 12 29
PETER-LINNARTZ-STRASSE
JUELICH 52428,
GERMANY



CAGE code: C15191

SCHRAUBENFABRIK GUSTAV STERNBERG GmbH & CO. KG
1000 BERLIN 27
BREITENBACHSTRASSE 11-12
GERMANY

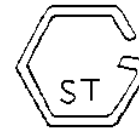

Symbol may be raised or struck in.

CAGE code:

SCHUHL & CO. GMBH
AUF DER HUTTE 31
WINTERBURG 59955
GERMANY

S

CAGE code: C3639

SCOTT CRAFT CO.

P.O. BOX 430
BELL, CA 90201

Plant
4601 CECELIA STREET
CUDAHY, CA 90201

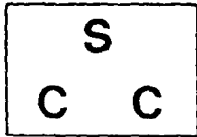

CAGE code: 28418

SCREWCORP

13001 EAST TEMPLE AVE.
CITY OF INDUSTRY, CA 91714

NO LONGER IN BUSSINESS

see ARCONIC FASTENING SYSTEMS &
RINGS

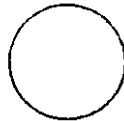

Indented circle on all fasteners,
except machine screws.

CAGE code: 9H901

**SEILER INSTRUMENT AND
MANUFACTURING COMPANY, INC.**

3433 TREE COURT INDUSTRIAL BLVD.
SAINT LOUIS, MO 63122

11934

CAGE code: 11934

SEMBLEX CORPORATION

199 W. DIVERSEY AVE
ELMHURST, IL 60126

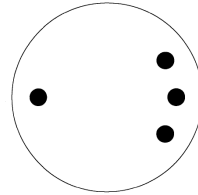
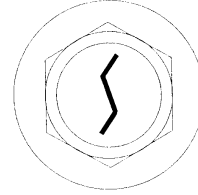

CAGE code: 4M343

SEMCO FASTENER

4146 EAST BALDWIN RD.
HOLLY, MI 48442

see RING SCREW WORKS



CAGE code: 0B2C8

SEMS AND SPECIALS, INC.

6483 FALCON RD.
ROCKFORD, IL 61109

01IG

CAGE code: 5B4N5

SENG HENG ENGINEERING PTE LTD.

NO. 3 EUNOS AVE. 8A
SINGAPORE 409458
REPUBLIC OF SINGAPORE



CAGE code:

SESCO INDUSTRIES, INC.

P. O. BOX 242
110 - 19 15TH AVENUE
COLLEGE POINT, NY 11356



CAGE code: 0KH97

SET SCREW & MFG. CO.

1210 ST. CHARLES STREET
ELGIN, IL 60120

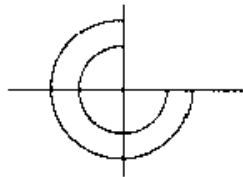

CAGE code: 1T4U7

SHACKELFORD MACHINIG, INC.

2407 LUDELLE ST.
FORT WORTH, TX 76105-0755



CAGE code: 4K446

SHAMROCK FASTENER TECHNOLOGIES, LLC.

6125 18 MILE ROAD
STERLING HEIGHTS, MI 48314

SHAMROCK IN CIRCLE

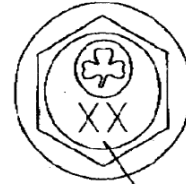

GRADE
DESIGNATION

SFT LOGO



GRADE
DESIGNATION

CAGE code: 05CF6

SHAW PRECISION GRINDING & THREADING

6503 W. FRYE RD.
SUITE 6
CHANDLER, AZ 85226

SALES ADDRESS:
see ACE GRINDING & MFG. OF TEXAS
2610 AERO DR.
GRAND PRAIRIE, TX 75052
CAGE code: 5U074



CAGE code: 1KRG8

SHEFFIELD, INC.

1025 WINCHESTER AVE.
KANSAS CITY, MO 64126



CAGE code: 68567

SHEREX FASTENING SOLUTIONS, LLC

400 RIVERWALK PARKWAY, SUITE 600
TONAWANDA, NY 14150

Plant
850 MOE DRIVE
AKRON, OH 44310



CAGE code: 7EK30

SHIGA BOLT CO., LTD.

OTSU 423 MINAMI-TSUCHIYAMA
TSUCHIYAMA-CHO, KOHGA-GUN SHIGA-
KEN 528-02
JAPAN

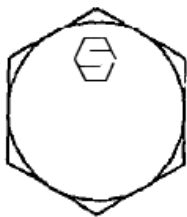

CAGE code:

SHOPCO MANUFACTURING, INC.

1125 S. CEDAR HILL RD.
CEDAR HILL, TX 75104

SC OR 1HEW6
Contoured to fit parts

CAGE code: 1HEW6

SHORELINE MACHINE PRODUCTS, INC.

19301 ST. CLAIR AVENUE
CLEVELAND, OH 44117

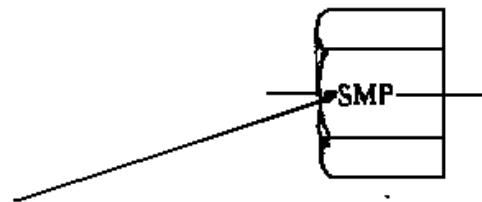

SMP will be applied to this surface to denote
Shoreline Machine Products as manufacturer.

CAGE code: 1VN42

SHUR-KUT SUPPLY CORPORATION

7 MT. PLEASANT DR.
ASTON, PA 19014



CAGE code: 6R002

SHUR-LOK COMAPNY.

2541 WHITE ROAD
IRVINE, CA 92614 - 6235



CAGE code: 97393

SIERRA PACIFIC SUPPLY CO., INC.

P. O. BOX 4848
COMPTON, CA 90224

Plant:
1801 W EL SEGUNDO BLVD
COMPTON, CA 90224

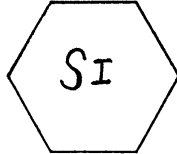

CAGE code: 5G098

SIERRACIN/HARRISON

3020 EMPIRE AVENUE
BURBANK, CA 91504

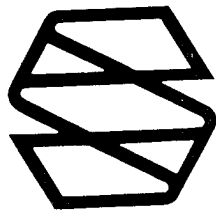

CAGE code: 08199

SIMFER PRECISION MACHINE

42 MANNING RD.
BILLERICA, MA 01821

02KS2

CAGE code: 02KS2

SIMMONDS PRODUCTS

9 RUE DES CRESSONNIERES
72110 ST. COSME-EN-VAIRAIS
FRANCE

NO LONGER IN BUSSINESS

see ARCONIC FASTENING SYSTEMS &
RINGS

SD

CAGE code: F0224

SINN-TECH, INC.

48 GLEAM STREET
WEST BABYLON, NY 11704



CAGE code: 9J550

SKY CLIMBERS FASTENERS, LLC

1800 PITTSBURGH DRIVE
DELAWARE, OH 43015

SCF

CAGE code: 7TNP1

SKYLINE INDUSTRIES

1201 FORUM WAY SOUTH
FORT WORTH, TX 76140



CAGE code: 09986

**SMALL PARTS MANUFACTURING CO.,
INC.**

4401 NE MLK JR. BLVD.
PORTLAND, OR 97211

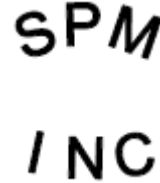

CAGE code: 3K749

SKYSPARES PARTS, INC.

6660 VIEW PARK COURT
RIVERSIDE, CA 92503



CAGE code: 6M132

SMITH MACHINE & MANUFACTURING

RT. 4 P.O. BOX 283
CANTON, TX 75103

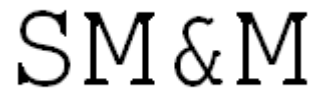

CAGE code: 0MAJO

SLABE MACHINE PRODUCTS

4659 HAMANN PARKWAY
WILLOUGHBY, OH 44094



CAGE code: 97139

SMITH WELDING, INC.

756 PRUNNER ROAD
RIDDLE, OR 97469



CAGE code: 1GQX1

SONFARREL, INC.

3000-3010 LA JOLLA ST.
ANAHEIM, CA 92806



CAGE code: 09036

SONIC INDUSTRIES, INC.

20030 SO. NORMANDIE AVE.
TORRANCE, CA 90502



CAGE code: 57928

SOUTH BAY BOLT MANUFACTURING CO.

P.O. BOX 5805
COMPTON, CA 90224

Plant
1775 W. El Segundo Blvd.
Compton, CA 90222

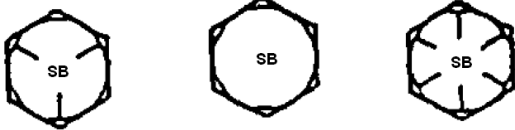

CAGE code: 2P339

SOUTHCO, INC.

210 N. BRINTON LAKE ROAD
CONCORDVILLE, PA 19331

Plant
SOUTHCO, INC. – TECATE
PROLONGACIAN, AV JUAREZ #999
FRACC. EL REFUGIO
TECATE, B.C., 21440 MEXICO



CAGE code: SV287

SOUTHERN FASTENER CORPORATION

P. O. BOX 1387
1641 CONCEPTION STREET ROAD
MOBILE, AL 36610



CAGE code: 1K461

SOUTHERN FASTENING SYSTEMS

P.O. BOX 1360
STATESVILLE, NC 28677

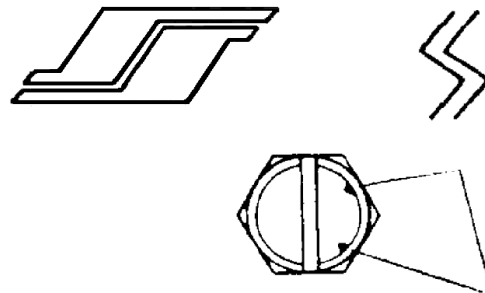

2 notches for slotted heads only

CAGE code: 87308

**SOUTHWEST ALLIED PRODUCTS CO.,
INC.**

299 HILL RD.
VANLEER, TN 37181



CAGE code: 6P461

SOUTHWEST INDUSTRIAL SERVICES

P. O. BOX 9084
FT. WORTH, TX 76147

Plant:
2413 WHITMORE
FT. WORTH, TX 76147



CAGE code: 6H920

SOUTHWIND INDUSTRIES, INC.

P.O. BOX 98
1646 OILD BUTLER PLANK RD.
PITTSBURGH, PA 15200



CAGE code: 0DTJ0

SPACE AGE ENGINEERING, INC.

4022 E. 26TH STREET
INDIANAPOLIS, IN 46218



CAGE code: 29953

SPACE CITY SCREW & MFG., INC.

21101 MCCLAIN RD.
CONROE, TX 77306



CAGE code:

SPACE SCREW, INC.

106 STANDARD ST.
EL SEGUNDO, CA 90245



CAGE code: 0GE51

SPACE-LOK, INC.

13306 HALLDALE AVE.
GARDENA, CA 90249

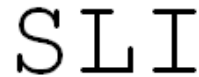

CAGE code: 16258

SPARTAN PRECISION MACHINE

131 ALBANY AVE
FREEPORT, NY 11520



CAGE code: 2M198

SPC THREADED

P.O. BOX 5279
MABANK, TEXAS 75147

Plant:
1231 VZ COUNTY ROAD 2312
MABANK, TEXAS 75147

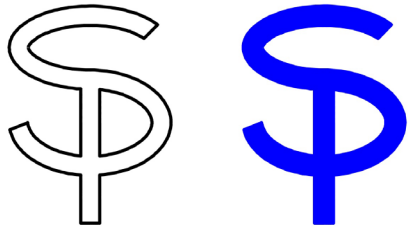

CAGE code: 7C9H3

SPEARMAN AEROSPACE

9215 GREENLEAF AVE.
SANTA FE SPRINGS, CA 90760

SA MFG

CAGE code: 8F922

SPECIALS, INC.

P.O. BOX 514
103 MAINLINE DRIVE
WESTFIELD, MA 01086-0514



CAGE code: 0WVC1

SPECIAL-T-METALS

P.O. BOX 14810
LENEXA, KS 66215

Plant
14740 WEST 101 TERRACE
LENEXA, KS 66215

STM

CAGE code: 8U495

SPECIALTY SCREW CORP.

P.O. BOX 5003
ROCKFORD, IL 61125

Plant:
2801 HUFFMAN BLVD.
ROCKFORD, IL 61103

S

CAGE code: 1WQE5

**SPENCER AEROSPACE
MANUFACTURING, LLC**

9131 GLENOAKS BLVD.
SUN VALLEY, CA 91331

SA

CAGE code: 6Z7R5

SPENCER INDUSTRIES, INC.

P.O. BOX 128
BELLEVILLE, NJ 07109

Plant
80 Holmes Street
Belleville, NJ 07109

SII

CAGE code: 21530

SPIRAL TOOL CORP.

761 ROUTE 6
SHOHOLA, PA 18458



CAGE code: 02108

SPRING CREEK MANUFACTURING, INC

18792 EAST STATE HWY 10
DANVILLE, AR 72833

SPCK

CAGE code: 8HKM8

SPRING INTERNATIONAL

23594 DOGWOOD TRAIL DRIVE, STE A
HOCKLEY, TX 77447



CAGE code: 75PX7

SPS TECHNOLOGIES

FASTENER DIVISION CORPORATE
HEADQUARTERS
301 HIGHLAND AVENUE
JENKINTOWN, PA 19046-2630
CAGE code: 56878

The following characters (used alone or in combination with other digits/ letters which designate material, size, strength grade or part number) indicate SPS as manufacturing source:

C	K	U
CCS	K-5673	U130
EWB	KS	UNBRAKO
FNF	S	UNW
HI PSI	SPS	56878
HI TI	TJB	71838
	TM9	80539

For "inch" socket head cap screws



Straight knurls with an unknurled band adjacent to the bearing surface on socket heads. The diameter over the straight knurl does not exceed the band. There may be 2 or 3 grooves near the band or a diamond knurl band at top of head.



A raised or depressed triangle pointing from the wrenching flat toward thread on nut products.



S-C used on metal nuts

SANTA ANA DIVISION
271 SO. HARBOR BLVD.
SANTA ANA, CA 92704-1259
(Cage 80539)

SPS SPS S S

CAGE code: 56878, 80539

(Continued)

(Continued)

T. J. BROOKS DIVISION
191, BARKBY ROAD'
TROON INDUSTRIAL AREA
LEICESTER
LE4 9HX, UNITED KINGDOM
(Cage K5673)



NORTH AMERICAN FASTENERS
AFG DIV
4444 LEE ROAD
CLEVELAND, OH 44128-2902
(Cage 1C5D9)

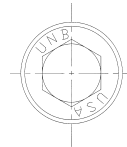

TERRY MACHINE
NORTH AMERICAN FASTENERS
5331 DIXIE HWY
WATERFORD, MI 48329
(Cage 495T1)



SPS TECHNOLOGIES (Cage U3575)
P O BOX 38
BURNABY ROAD
COVENTRY
CV 6 AE, UNITED KINGDOM

SPS INTERNATIONAL LTD. (Cage S3329)
UNBRACO SHANNON
BAYS 25-30 SHANNON INDUSTRIAL
ESTATE,
SHANNON, COUNTRY CLARE, IRELAND

METALAC SPS INDUSTRIA E
COMERCIO LTDA.
AVENIDA ITAVUVU, 4690
18078-005 SOROCABA (SP), BRAZIL

TELLEP TLP T 

CAGE code: K5673, IC5D9, 495T1, U3575, S3329

(Continued)

(Continued)
UNBRACO PTY LTD. AUSTRALIA
P.O. BOX 3138 NUNAWADING
VICTORIA 3131, AUSTRALIA

U UM

SPS TECHNOLOGIES LIMITED
T/A UNBRACO UK
CRANFORD STREET
SMETHWICK
B66 2TA, UNITED KINGDOM

TBJ

CAGE code: U3575

SPS TECHNOLOGIES LIMITED
TJ BROOKS DIVISION
191 BARKBY ROAD
TROON INDUSTRIAL AREA
LEICESTER
LE4 9HX, UNITED KINGDOM

TBJ

CAGE code: K5673

SPURWAY COOKE INDUSTRIES PTE LTD.
2, JOO KOON ROAD
JURONG SINGAPORE 628966
REPUBLIC OF SINGAPORE

**S
C I**

CAGE code:

SRI SAI INDUSTRIES CORPORATION

1207 FULTON AVENUE
SAN ANTONIO, TX 78201-5104

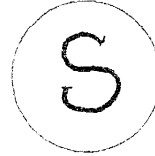

CAGE code: 63095

ST. LOUIS SCREW & BOLT CO.

6900 NORTH BROADWAY
ST. LOUIS, MO 63147



TYPE I



TYPE III

CAGE code:

STACY MACHINE & TOOLING, INC.

2810 INDUSTRIAL LANE
BROOMFIELD, CO 80020

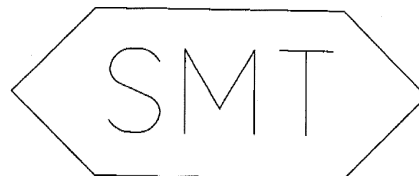

CAGE CODE: 1TT84

STALKER & DYSTHE, INC.
5100 E. WASHINGTON BLVD.
LOS ANGELES, CA 90040



CAGE code: 6D696

STANDARD LOCKNUT, INC.
P. O. BOX 780
1045 EAST 169TH STREET
WESTFIELD, INDIANA 46074



CAGE code: 78507

STANDARD NUT & BOLT, INC.
49 ABBOTT ST.
CUMBERLAND, RI 02864



CAGE code: 758C9

STANDARD TOOL & MACHINE CO.
205 E. CARSON ST.
PITTSBURGH, PA 15219

Plant
208 WOODLAND RD.
BIAWNOX, PA 15238

See HALL INDUSTRIES



CAGE code: 0KA69

STAR-GLO INDUSTRIES LLC
2 CARLTON AVE.
EAST RUTHERFORD, NJ 07073



CAGE code: 17384

STEADFAST CORPORATION
229 MARGINAL ST.
CHELSEA, MA 02150



CAGE code: 9X854

STEEL CITY BOLT & SCREW, INC.

P.O. BOX 1747
BIRMINGHAM, AL 35201

Plant
230 WEST VALLEY AVE.
BIRMINGHAM, AL 35209

SCB

CAGE code: 3N642

STEEL PRODUCTS OF MASSILLION

132 WALNUT RD S.W.
MASSILLION, OH 44646

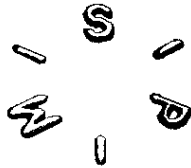

CAGE code: 0698X

STEEL WAREHOUSE COMPANY, INC.

2722 WEST TUCKER DRIVE
BOX 1377
SOUTH BEND, IN 46624

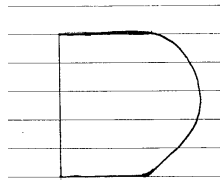

CAGE code: 0R1J8

STELCO FASTENER & FORGING CO.

1250 APPLEBY LINE
BULINGTON, ONTARIO L71 5G6
CANADA



Stelco trademark
for most
fasteners



Most other nuts
and bolts,
including metric



SAE Grade 5
hex nuts



SAE Grade 8
hex nuts

CONELOK LOCKNUTS

Inch series



Grade B



Grade C

Metric series



Class 5

Class 9

Class 10

Bearing surface

CAGE code:

(Continued)

(Continued)

STELCO FASTENER & FORGING CO.
1250 APPLEBY LINE
BULINGTON, ONTARIO L71 5G6
CANADA

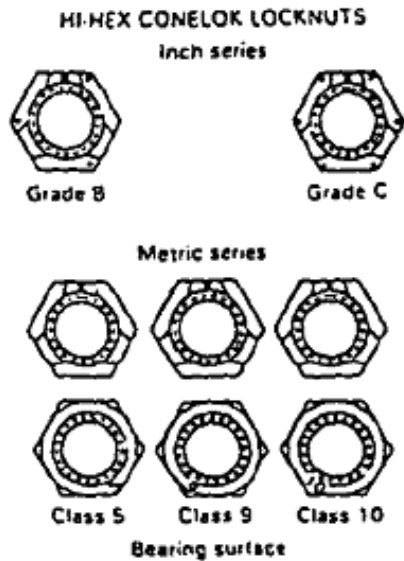

CAGE code:

STELFAST FASTENERS, INC.

2279 STELFAST PKWY
STRONGSVILLE, OH 44149



CAGE code: 1WXX8

STELFAST FASTENERS, INC.

DIVISION OF STELFAST FASTENERS, LTD.
1710 CLARKSTONE ROAD
CLEVELAND, OH 44112

1/4 in. through 3/4 in. hex cap screws, heavy hex bolts, square head bolts, and specialty externally threaded fasteners, cold headed.



3/4 in. through 2 1/4 in. reg. hex bolts, heavy hex bolts, square head bolts, and specialty externally threaded fasteners, hot headed.



1/4 in. through 2 1/2 in. studs.

2 3/8 in. through 3 in. reg. hex bolts, heavy hex bolts, square head bolts, hot headed, and specialty externally threaded fasteners.

CAGE code:

STELFAST, INC.

1090 MEYERSIDE DRIVE
MISSISSAUGA, ONTARIO L5T 1J4
CANADA



(see Chiang Shin Fasteners Industries)
DOING BUSINESS UNDER STELFAST
CHIANG SHIN FASTENERS INDUSTRIES, LTD
NO. 111 WANLI ROAD
GANGSHAN TOWNSHIP,
KAOHSIUNG COUNTRY 82050,
TAIWAN (R.O.C)

CAGE code: SFV96

CAGE code: L8367

STERLING MACHINE COMPANY

23 FARRAR STREET
LYNN, MA 01901-1699

2

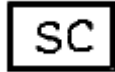

CAGE code: 03983

STERLING MARKING PRODUCTS IC

P.O. BOX 3360 STA A
349 RIDOUT ST N
LONDON, ONTARIO, CANADA NGA 4K3



CAGE code: 37084

STERLING MFG. & SUPPLY, INC.

P.O. BOX 8205
FORT WORTH, TEXAS 76124

Plant
3623 E. VICKERY BLVD.
FORT WORTH, TX 76105



or

60529

Steel stamped
or
Embossed
or
Rubber stamped

CAGE code: 60529

STEVENS MFG. CO., INC.

P.O. BOX 3041
MILFORD, CT 06460

Plant
280 ROCK LANE
MILFORD, CT 06460

MFR 8F781

8F781

CAGE code: 8F781

STILLWATER FASTENERS, INC.
25 GURNEY ROAD
EAST FREETOWN, MA 02717-1107

SW & ..

Symbols are "SW", ampersand ("&") or ".."

CAGE code: 1Y153

STRENKERT MACHINE SHOP INC.
RD #2, BOX 759
INDIAN BROOK ROAD
GREENE, NY 13778

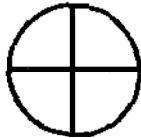

CAGE code: 2T174

STURM MACHINE CO., INC.
9846 OWENSMOUTH AVE.
CHATSWORTH, PA 91311



CAGE code: 64733

SUBCON TOOL / ACCUTOOL MACHINE GROUP
DBA ACCUTOOL

01FO

CAGE code: 64733

SUBURBAN INDUSTRIES, INC.
11901 FRANKLIN AVE
FRANKLIN PARK, IL 60131

SII

CAGE code: 89752

SUGAR RIVER MACHINE SHOP
667 PROGRESSIVE LANE
SOUTH BELOIT, IL 61080

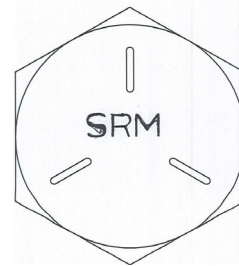

CAGE code: 1XAX4

SULLIVAN BOLT CO., INC.

3435 SOUTH MALT AVE.
COMMERCE, CA 90040

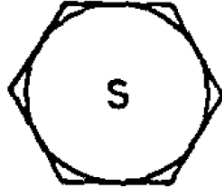

CAGE code: 6M158

SUNDRAM FASTENERS, LTD.

MADRAS, INDIA

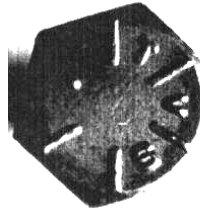

CAGE code:

SUNLAND AEROSPACE FASTENERS

12920 PIERCE STREET
PACOIMA, CA 91331



CAGE code: 6VDQ4

SUNRISE PRECISION MFG.

4406 ENTERPRISE PL, UNIT 3
FREMONT, CA 94538



CAGE code: 0UK47

SUPERIOR TECHNOLOGY

11013 OLINDA STREET
SUN VALLEY, CA 91352



EARTH

CAGE code:

SUPREME SCREW PRODUCTS, INC.

1368 CROMWELL AVENUE
BRONX, NY 10452

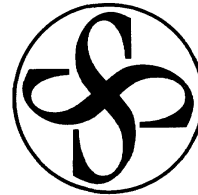

CAGE code: 1FMQ2

S V INDUSTRIES

29280 YNEZ RD.
TEMECULA, CA 92592



CAGE code: OGVY7

SWISS TECHNOLOGY, INC.

9 BRIDEWELL PL.
CLIFTON, NJ 07014

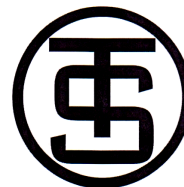

CAGE code: 48406

T & E MACHINE CORP.
4519C WAYNE AVENUE
PHILADELPHIA, PA 19144-3606

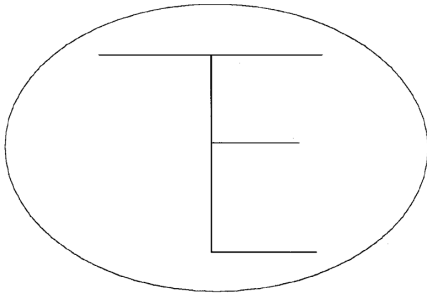
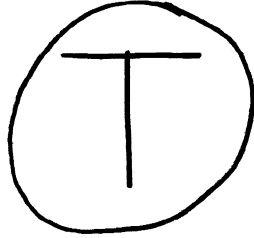

CAGE code: 059P5

T C QUALITY MACHINING INC.
12155 MAGNOLIA AVE STE 10D
RIVERSIDE, CA 92503 - 4905

TCQ

CAGE code: 3H5W3

T R MACHINE INC.
103 STATE ROUTE 75 E
DAVIS, IL 61019-9586

TR

CAGE code: 1YJV1

TAIYO NUT MFG. CO., LTD.
2-6-12 KOUZEN, IKARUGACHO
IKOMA-GUN, NARA, JAPAN

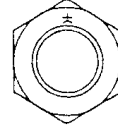

CAGE code:

TAKENAKA SEISAKUSHO CO., LTD.
178 HISHIE
HIGASHI OSAKA CITY, JAPAN 578

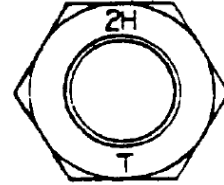
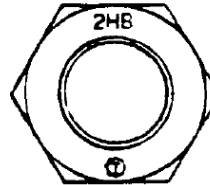
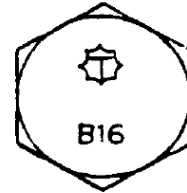
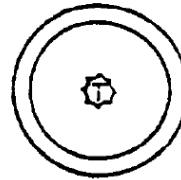

CAGE code:

TANAKA LTD.
1-10-6 TEZUKAYAMA-NAKA
SUMIYOSHI-KU, OSAKA, JAPAN

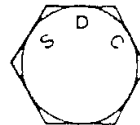

SDC

CAGE code: SP833

T-B & S MFG.

4404 GARLAND DRIVE
FORT WORTH, TX 76117

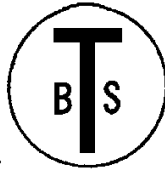

CAGE code:

TEBCO THREADED FASTENERS

2700 SUMMER AVENUE
MEMPHIS, TN 38112

Plant
665 SCOTT STREET
MEMPHIS, TN 38112

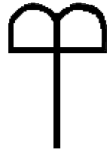

CAGE code: 4K536

TECH WELDING AND MACHINE CO.

41 KINGSTON AVENUE
COLUMBUS, OH 43207



CAGE code: 9Y179

TECHNICAL FASTENERS, INC.

1129 GRIMMITT DR
SHREVEPORT, LA 71107



CAGE code: 0GV34

TEK PRECISION CO., LTD.

205 WEST INDUSTRY COURT
DEER PARK, NY 11729



CAGE code: 65780

TELEFAST INDUSTRIES, INC.

777 W BAGLEY RD
BEREA, OH 44017-2901

Division of ELGIN FASTENER GROUP LLC.



TF



TF USA

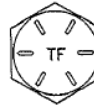

CAGE code: 3CW33

TENS MACHINE CO., INC.
800 GRUNDY AVE.
HOLBROOK, NY 11741-2606



TENS

CAGE code: 8P689

TERRY MACHINE CO.
P.O. BOX 487
5331 DIXIE HWY.
WATERFORD, MI 48095-1

See SPS TECHNOLOGIES



CAGE code: 87880

TERRYCABLE, INC.
17376 EUCALYPTUS STREET
HESPERIA, CA 92345

TC

CAGE code: 0XZ68

TEXAS BOLT CO.
P.O. BOX 1211
3235 W. 11TH ST.
HOUSTON, TX 77251



CAGE code: 27422

TEXAS PRECISION MFG., INC.
P.O. BOX 3640
610 28TH ST
LUBBOCK, TX 79452

Plant
1204 E. 46TH STREET
LUBBACK, TX 79404

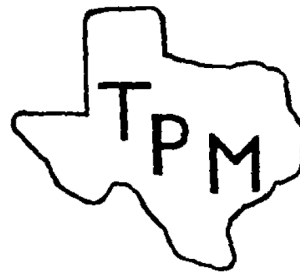

CAGE code: ICU57

TEXTRON FASTENING SYSTEMS

1224 E. WARNER AVENUE
SANTA ANA, CA 92705

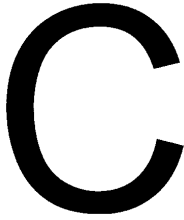

LOCKBOLTS
Bold "C"

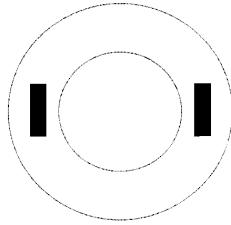

LOCKBOLT COLLARS
Two Opposing Dashes

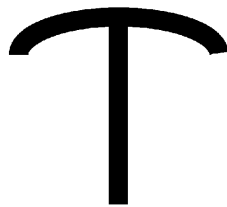

ALL PRODUCTS
Lazy "T"

CAGE code: 11815

TFI AEROSPACE CORPORATION

625 RIDDELL ROAD
ORANGEVILLE, ONTARIO, CANADA

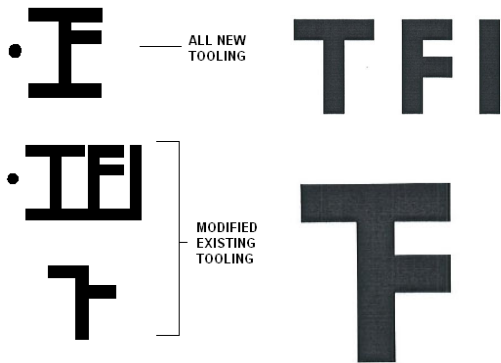

CAGE code: L0336

TFP CORP.

P. O. BOX 952
MEDINA, OH 44258

Plant
TRU-FIT STEEL WIRE CO.,LTD
(TRU-WELD DIVISION)
460 LAKE ROAD
MEDINA, OH 44258

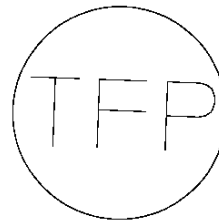
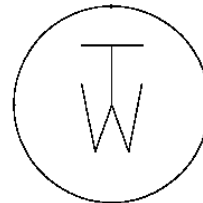
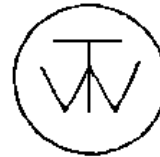

CAGE code: 31000

THIANT (BOULONNERIE DE SA)

B.P. 4
FRANCE 59224



This marking appears on all hex nuts with or without deflection marks. The three raised lines in the corner indicate "Thiant" as manufacturer. (Clockwise system for grade.)



This marking appears on all flange nuts. The three raised lines on the flange indicate "Thiant" as manufacturer. (Clockwise system for grade.)



This marking appears on flange nuts when no mark is acceptable on the flange. Three depressed lines indicate "Thiant" as manufacturer. (Clockwise system for grade.)

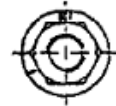

This marking appears on flange nuts when raised marks are not accepted. Three depressed lines indicate "Thiant" as manufacturer. (Clockwise system for grade.)

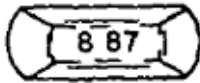

TRACKS FASTENERS



HIGH STRENGTH STRUCTURAL BOLT



HOT FORGED BOLTS

CAGE code:

THOMAS & BETTS CORPORATION

(FORMERLY AMERICAN ELECTRIC)
8155 T AND B BLVD
MEMPHIS, TN 38125 - 8888

Plant 1
260 DENNIS STREET
ATHENS, TN 37303

Plant 2
8735 HAMILTON ROAD
SOUTHAVEN, MS 38671

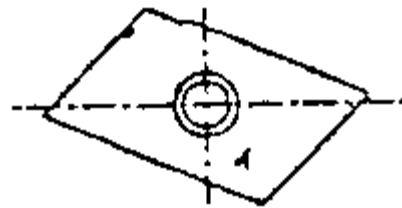

CAGE code: 56501

THOMAS INSTRUMENT & MACHINE CO., INC.

3440 E FIRST ST
BROOKSHIRE, TX 77423 - 0999



CAGE code: 5H860

THOMAS MACHINING TECHNOLOGIES, INC.

12 COUNT ROAD 486
HANCEVILLE, AL 35077



CAGE code: 1VNC4

THOMAS MFG, INC.
25125 W OUTER DR
MELVINDALE, MI 48122

THOMAS

CAGE code: 0NWS1

TITAN FASTENER
10031 HOLLY ROAD
HOLLY, MI 48442

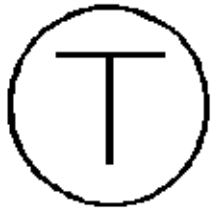

CAGE code:

TOG MANUFACTURING CO., INC.
1454 SOUTH STATE STREET
NORTH ADAMS, MA 01247



CAGE code: 63649

TOKOSHA METAL WORKS LTD.
NO. 7-22, 3-CHROME, NAKAGAMA-NISHI,
IKUNO-KU, OSAKA, JAPAN

TKS

CAGE code:

TONG HWEI ENTERPRISE CO., LTD.
NO. 399 GANG YAN ROAD
GANG SHAN 820, KAOHSIUNG
TAIWAN, R.O.C.

THE

CAGE code: None

TOOLEX, INC.
7570 MORLEY STREET
HOUSTON, TX 77061



CAGE code: 1W383

TOPURA CO., LTD.
2050 YAJOI-CHO
HIGASHIOSAKA-SHI,
OSAKA, JAPAN 579

Plant
201 SOYA, HATANO,
KANAGAWA 257 JAPAN

TOPURA

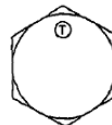

TP

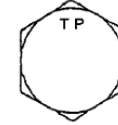
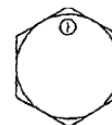

CAGE code:

TORCO, INC.

P. O. BOX 4070
1330 OLD HIGHWAY 41
MARIETTA, GA 30061

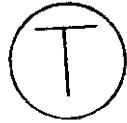

CAGE code: 07359

TORONTO FASTENERS INDUSTRIES, INC.

SUBSIDIARY OF HI-SHEAR CORP., USA
7475 KIMBEL ST., UNIT 8
MISSISSAUGA, ONTARIO L5S1E7

See HI-SHEAR

Plant
19 CONSTELLATION CT.
REXDALE, ONTARIO,
CANADA M9W 1K4



CAGE code:

TORX PRODUCTS

CAMCAR DIVISION OF TEXTRON INC.
P. O. BOX 607
HWY 31 N.
ROCHESTER, IN 46975

For head markings see:

CAMCAR Division of Textron, Inc.
Plant
TORX Products

CAGE code: 6N040

TOWNE ROBINSON FASTENER CO.

KEY MANUFACTURING GROUP, INC.
P.O. BOX 232
24175 NORTHWESTERN HWY.
SOUTHFIELD, MI 48037



Plant
4401 WYOMING AVE.
P.O. BOX 188
DEARBORN, MI 48121



CAGE code: 94678

TOWNSEND CO.

CHERRY RIVET DIVISION
1224 E. WARNER AVE.
SANATA ANA, CA 92701

-  Aircraft blind rivets.
-  Aircraft lockbolts.

CAGE code: 7H092

TOYO STEEL WIRE CO., LTD.

3-9-45 TSURUHARA
IZUMISANO-SHI, OSAKA,
598 JAPAN

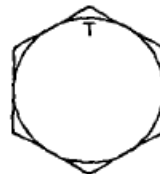

CAGE code:

TRI STATE TOOL & DIE CO.

1396 NORTON RD
STOW, OH 44224-1333

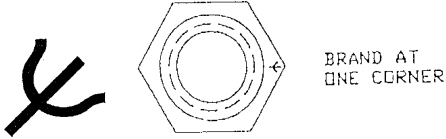

CAGE code: 06RM8

TRIEM INDUSTRIES, LLC

105 NAPCO DRIVE
TERRYVILLE, CT 06786



CAGE CODE: 63TA9

TRIAD PRODUCTS CORP.

15241 N.E. 92ND
REDMOND, WA 98052



CAGE code: 74468

TRIUMPH GROUP OPERATIONS INC

THE FRISBY AEROSPACE INC DE
417 S. MAIN ST.
FREEPORT, NY 11520-5144

Ssee FRISBY AEROSPACE INC DE



CAGE code: 26437

TRIDAIR PRODUCTS

3000 WEST LOMITA BLVD.
TORRANCE, CA 90505-5103

NO LONGER IN BUSINESS

see REXNORD INC.



CAGE code: 29372

TRIUMPH MANUFACTURING CO., INC.

P.O. BOX 380148
750 TOLLAND ST.
EAST HARTFORD, CT 06138



CAGE code: 8X098

TRIDENT MACHINE CO.

3491 N. MERIDIAN ROAD
ROCKFORD, IL 61101



CAGE code: 5N818

TRONSON MANUFACTURING

45383 INDUSTRIAL PLACE #41
FREEMONT, CA 94538



CAGE code: 1DPK8

TROY D. RAY DBA DIXON MACHINE & FABRICATION

6807 CHAPMAN HWY.
KNOXVILLE, TN 37920-6560

DMT

CAGE code: 1DEP3

TRW

FASTENER DIVISION
265 THIRD STREET
CAMBRIDGE, MA 02142

PAL

Logo Stampings Used on
Brass Snap Fastener Components

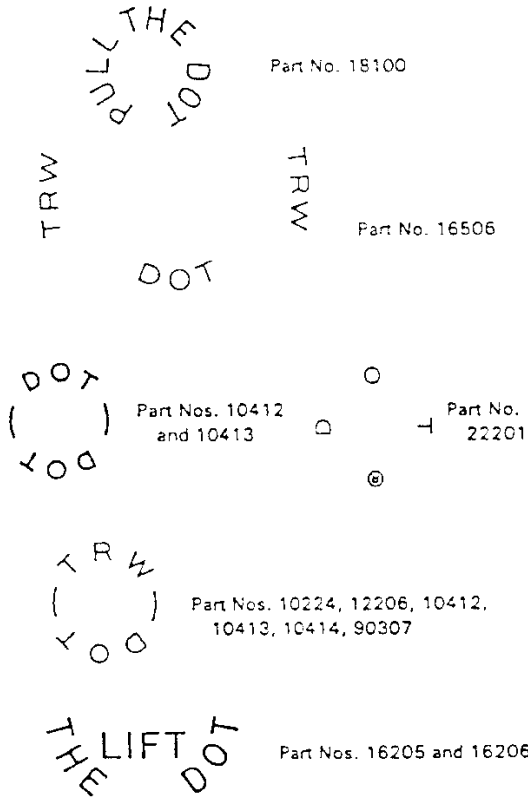

CAGE code: 83058

TRW ELECTRONIC COMPONENTS

CINCH – MANADNOCK DIVISION
18300 EAST VALLEY BLVD.
CITY OF INDUSTRY, CA 91714

NO LONGER IN BUSINESS

see MONADNOCK COMPANY, THE

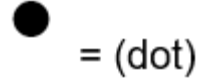

CAGE code: 76530

TRY - AZTEC COMPANY

P.O. BOX 6191
TEHACHAPI, CA 93561

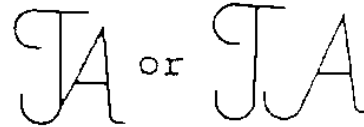

CAGE code:

TS TEKNADYNE

P.O. BOX 366
COTTONWOOD, ID 83522

Plant:
165 RESERVOIR ROAD
COTTONWOOD, ID 83522

TST

CAGE code: 62W81

TSL SERVICES

P.O. BOX 8596
BACLIF, TX 77518

Plant:
2311 BAYLINE DRIVE
DICKINSON, TX 77539

TSL

CAGE code: 84B36

TUFF FASTENERS CO.

10724 GARWICK PLACE
SOUTH GATE, CA 90280-7332

T

CAGE code: 5V629

TURNAMICS, INC.

92 NEW LIECHESTER HWY
ASHVILLE, NC 28806

K&T

CAGE code: 1CWU8

**TW DESIGN AND MANUFACTURING,
L.L.C.**

P. O. BOX 310
33 WEST STREET
MONTELLO, WI 53949

W

CAGE code: 0X311

TWIST TITE MFG. INC.

13649 PUMICE STREET
SANTA FE SPRINGS, CA 90670

M or TT

CAGE code: 007R1

UDT, INC.

2304 GRANT AVENUE
PANAMA CITY, FL 32405

 **UDT**
fabrication | prototyping

CAGE code: 57547

U.P. MACHINE & ENGINEERING CO.

P.O. BOX 400
210 NORTH THIRD STREET
POWERS, MI 49874

UPME

CAGE code: 5H091

U.S. BOLT MANUFACTURING, INC.

12895 SOUTH MAIN
HOUSTON, TX 77035



CAGE code: 0UZJ8

U.S.A SPARES INC

1729 W TRINDLE RD
CARLISLE, PA 17013-9758



CAGE code: 1UF60

ULTIMATE MACHINING & WELDING

1003 ARGUELLO STREET
REDWOOD CITY, CA 94063



CAGE code: OXXP2

ULTRA SONIC MACHINE CO., INC.

1313 WEST 135TH STREET
GARDENA, CA 90247

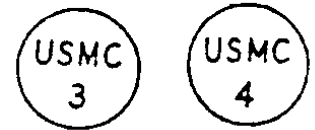
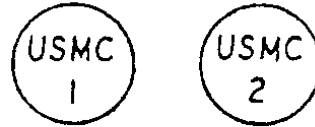

CAGE code: 4F713

UMPCO CORP.

P.O. BOX 5158
7100 LAMPSON AVE.
GARDEN GROVE, CA 92841



CAGE code: 18076

UNIFLOW CORP.

P.O. BOX 705
26600 HEYN DRIVE
NEW HAVEN, MI 48050

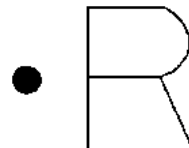

CAGE code: 4S622

UNICORP

P.O. BOX 280
ORANGE, NJ 07051-0280

UEH

Plant
291 CLEVELAND ST
ORANGE, NJ 07050

CAGE code: 04729

UNIMETERIC CORPORATION

P.O. BOX 4529
5 TRIPPS LANE
EAST PROVIDENCE, RI 02915

U

CAGE code: 7U319

UNISTRUT CORP.

(UNISTRUT PHILA)
761 FIFTH AVE
KING OF PRUSSIA, PA 19406

Plant
UNISTRUT CORP.
WAYNE MFG. DIV.
35660 CLINTON
WAYNE, MI 48184

UNISTRUT



CAGE code: 96195

UNITED BOLT & SCREW CORP.

1055 HAGGERTY AVE.
DEARBORN, MI 48126



CAGE code: 8G949

UNITED DRILL BUSHING CORP.

12200 WOODRUFF AVE
DOWNEY, CA 90241

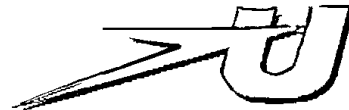

CAGE code: 52369

UNITED PRECISION PRODUCTS CO., INC.

25040 VAN BORN ROAD
DEARBORN HEIGHTS, MI 48125

UP

CAGE code: 17328

UNITED STATES DEFENSE RESEARCH & SUPPLY

311 EASTRIDGE ROAD
GRANDBURY, TX 76049



CAGE code: 0XVD5

UNITED STEEL & FASTENERS INC.

1500 INDUSTRIAL DRIVE
ITASCA, IL 60143

S^UF



Identification used on all large bolts



Identification used on all small bolts and on the shoulders of nuts



CAGE code: 2R938

UNITED TITANIUM, INC.

3450 OLD AIRPORT RD.
WOOSTER, OH 44691



CAGE code: 1F103

UNIVERSAL MACHINE PRODUCTS

480 SURF AVENUE
STRATFORD, CT 06497



CAGE code: 0Y156

UNIVERSAL PRECISION SCREWS

NH10, DELHI ROHTK RD
KHARAWAR BYE-PASS
ROHTAK, HARYANA, INDIA 124001



CAGE code: 2656Y

UNLIMITED SCREW PRODUCTS, INC.

87 E. JEFFRYN BLVD.
DEER PARK, NY 11729

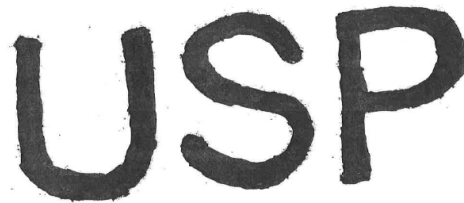

CAGE code: 6T970

UPB ENGINEERING

13060 TOM WHITE WAY
"UNIT F"
NORWALK, CA 90650

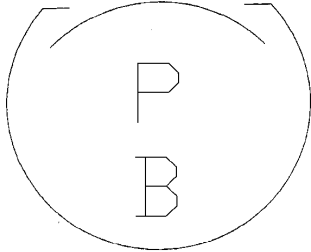

CAGE code: 1BER9

UPSTART ACQUISITIONS, CORP.

10825 BARELEY LANE
SUITE P
HOUSTON, TX 77070



CAGE code: 5F5J7

URANIA ENGINEERING CO., INC.

198 SOUTH POPLAR STREET
HAZLETON, PA 18201



CAGE code: 30279

URBAN MANUFACTURING CO.

P.O. BOX 4260
100 W. BERKLEY STREET
PHILADELPHIA, PA 19144

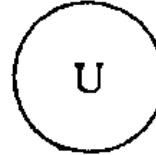

CAGE code: OW5R7

URBAN MFG. CO. INC.

P.O. BOX 1070
529 FORREST AVENUE
DREXEL HILL, PA 19026

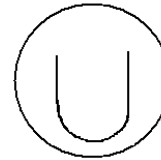

CAGE code: 9Y188

US TOOL & DIE

23282 VERDUGO DRIVE
LAGUNA HILLS, CA 92653-1335

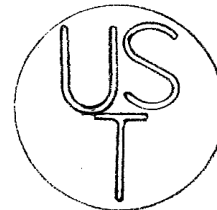

CAGE code: 3LJM2

USP AEROSPACE SOLUTIONS, INC.

81 E. JEFRYN BLVD.
UNIT G
DEER PARK, NY 11729

USP

CAGE code: 7CPR7

UTAH TOOL & DIE, INC.

P.O. BOX 969
850 NO WESTERN PRECISION PARKWAY
WEST JORDAN, UTAH 84084



CAGE code: 23509

VALCOR ENGINEERING CORP.

2 LAWRENCE ROAD
SPRINGFIELD, NJ 07081

VALCOR

CAGE code: 96487

VALLEY FORGE AND BOLT MFG CO.

1825 S. 27th AVENUE
PHOENIX, AZ 85009-6417



CAGE code: 02UA5

VALLEY-TODECO

12975 BRADLEY AVE.
SYLMAR, CA 91342

NO LONGER IN BUSINESS

see ARCONIC FASTENING SYSTEMS &
RINGS



VT

CAGE code: 06710

VAN PETTY MFG., INC.

2517 AZURITE CIRCLE
NEWBURY PARK, CA 91320

NO LONGER IN BUSINESS

see ARCONIC FASTENING SYSTEMS &
RINGS



CAGE code: 23899

VANTAGE POINT MANUFACTURING

P.O. BOX 859
WEST BRANCH, MI 48661

Plant:
614 PARKWAY DRIVE
WEST BRANCH, MI 48661

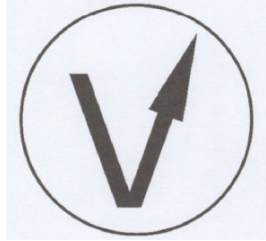

CAGE code: 83VW2

V-B MACHINE CO., INC.

FASTENER DIVISION
1645 W. 135TH STREET
GARDENA, CA 90249



CAGE code: 60682

VEGAS FASTENER MANUFACTURING

3873 W. OQUENDO ROAD
LAS VEGAS, NV 89118



CAGE code: 1U1Z3

VEGAS FASTENER MANUFACTURING

10217 BRECKVILLE RD.
CLEVELAND, OH 44141

Plant:
4315 WEST OQUENDO ROAD
LAS VEGAS, NEVADA 89118



CAGE code: 6YPM1

VENUS FASTENERS CORP.

154 MERRICK RD
FREEPORT, NY 11520



CAGE code: 045B2

VERSATECH, INC.

P.O. BOX 608
6012 ENTERPRISE DR.,
WESTMORELAND INDUSTRIAL PARK III
EXPORT, PA 15632



CAGE code: 0CHD0

VERTEX DISTRIBUTION

P. O. BOX 879
327 PINE STREET
PAWTUCKET, R 02860

(see BELL FASTENERS)

PMC

CAGE code:

VIP MFG. & ENGR. CORP.

1084 MARTIN AVE.
SANTA CLARA, CA 95050

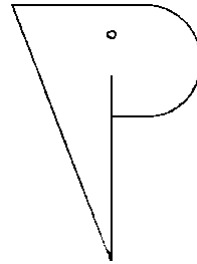

CAGE code: 8M774

VICO PRODUCTS, CO.

41555 E. ANN ARBOR ROAD
PLYMOUTH, MI 48170

V

The "V" is either raised or indented.

CAGE code: 0CG15

**VISSERIES & BOULONNERIES DE
FOURMIES**

2 RUE DU CHAUFFOUR
FOURMIES, FRANCE 69610

F

F.K

Grade 8.8 and over

CAGE code: F8388

VICTOR PRODUCTS CORP.

2635 WEST BELMONT
CHICAGO, IL 60618



CAGE code: 63045

VISTA MACHINING COMPANY

100 NU ENERGY DR.
BLDG. A, SUITE 1
ALEDO, TX 76008

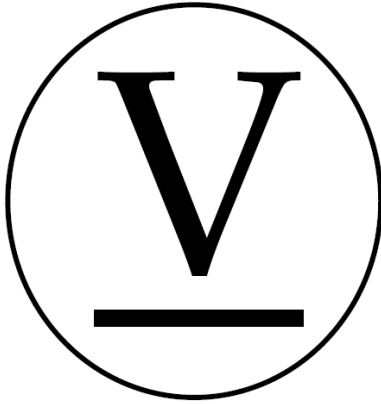

CAGE code: 56KU2

VISTEK INDUSTRIES

153 RAILROAD DR
IVYLAND, PA 18974-1448

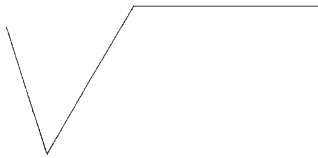

CAGE code: 79735

VITCO NUCLEAR PRODUCTS INC.

8171 TYLER BLVD
MENTOR, OH 44060



CAGE code: 9L424

VM MANUFACTURING CORP.

1536 RAILROAD AVENUE
HOLBROOK, NY 11741-2301

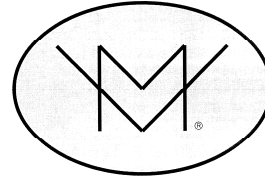

CAGE code: 1NUW9

VMC INDUSTRIES, INC.
20 CORPORATE DRIVE
AUBURN HILLS, MI 48326

.V. OR **VMC**

FEMALE FASTENERS

PREVAILING TORQUE NUTS

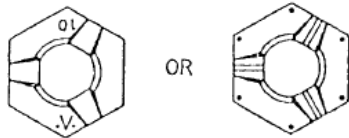

.V. OR TWO LINES IN THREE PADS
WITH APPROPRIATE GRADE OR CLASS MARKINGS

INSERT TYPE
PREVAILING TORQUE NUTS



TAN NYLON IDENTIFIES VMC AS MANUFACTURER
WITH APPROPRIATE GRADE OR CLASS MARKINGS

SLOTTED NUTS

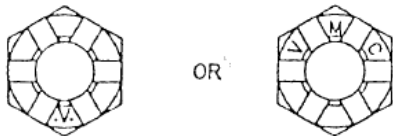

.V. OR VMC
WITH APPROPRIATE GRADE OR CLASS MARKINGS

CAGE code: 0SFN8

(Continued)

(Continued)

VMC INDUSTRIES, INC.

FEMALE FASTENERS (CONT.)

NUT & WASHER ASSEMBLY

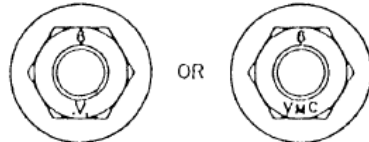

".V." OR "VMC" WITH APPROPRIATE
GRADE OR CLASS MARKINGS

FLANGE NUTS

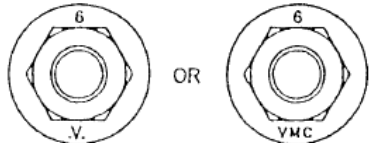

".V." OR "VMC" WITH APPROPRIATE
GRADE OR CLASS MARKINGS

HEX NUTS

ENGLISH

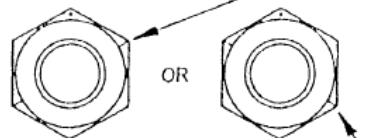

GRADE 5 PER SAE J995 OR GRADE 8 PER SAE J995
ONE RADIAL LINE FOR MFG. ID., 180°
FROM RADIAL LINE IN THE GRADE ID.

METRIC

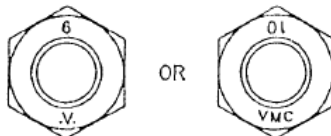

CLASS 9 OR CLASS 10
".V." OR "VMC" WITH APPROPRIATE
GRADE OR CLASS MARKINGS

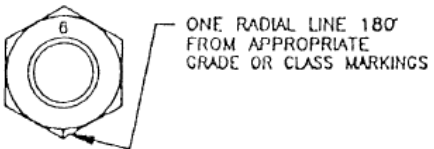

CAGE code: 0SFN8

(Continued)

(Continued)

VMC INDUSTRIES, INC.

FEMALE FASTENERS (CONT.)

OTHER TYPE NUTS

WHEEL NUTS, HEX AND SQUARE
WELD NUTS AND OTHER TYPE
NUTS NOT SPECIFIED.
".V." OR "VMC" WITH APPROPRIATE
GRADE OR CLASS MARKINGS

MALE FASTENERS

SOCKET HEADS

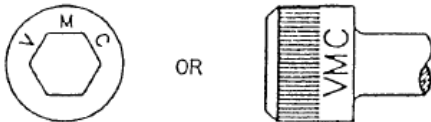

HEX HEADS

INDENTED, TRIMMED, WASHER
OR FLANGED.

METRIC

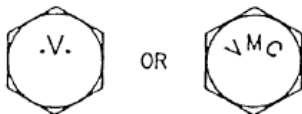

ENGLISH

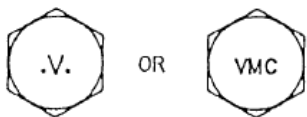

".V." OR "VMC" WITH APPROPRIATE
GRADE OR CLASS MARKINGS

CAGE code: 0SFN8

VOI-SHAN PRODUCTS

NO LONGER IN BUSINESS
see ARCONIC FASTENING SYSTEMS &
RINGS

3000 WEST LOMITA BLVD.
TORRANCE, CA 90505-5103
CAGE code: 5M902

VS

135 N. UNRUH AVE.
CITY OF INDUSTRY, CA 91744
CAGE code: 06950, IRC86

VS

O

SC

STEVEN 3
31135 HILDESHEIM-BEVENSTEDT,
GERMANY
CAGE code: C4293

VS

CAGE code: 5M902, 06950, IRC86, C4293

VORTEX MFG CO.

60 SUNSHINE FARM DRIVE
SOMERS, CT 06071

VMC

CAGE code: 4AUV8

VOSS INDUSTRIES, INC.

VOSS AEROSPACE DIVISION
2168 WEST 25TH STREET
CLEVELAND, OH 44113



E A

V

CAGE code: 14242

VSI

AEROSPACE PRODUCTS DIVISION
557 S. DOUGLAS ST.
EL SEGUNDO, CA 90245

Plant
VOI-SHAN DIVISION
4001 INGLEWOOD AVE.
REDONDO BEACH, CA 90278

VS

CAGE code: 6A768

VULCAN RIVET & BOLT CORP.

P.O. BOX 170129
BIRMINGHAM, AL 35217

V.

All fasteners marked with the letter "V" followed by a period (.)

V.

Fasteners manufactured from special alloy steels are identified with the letter "V" followed by a period (.) and a line under the letter "V"

**304
V.**

Stainless steel fasteners are marked with the letter "V" followed by a period (.) with the type of stainless

CAGE code: 0GEW3

WA TAI INDUSTRIAL COMPANY, LTD

NO 2, LANE 29
MIN-CHUAN ROAD, LU-CHU HSIANG,
KAOHSIUNGHSIEN,
TAIWAN, ROC

WT



CAGE code: NONE

WALKER BOLT MANUFACTURING CO., INC.

P.O. BOX 1149
10202 AIRLINE CRIVE
HOUSTON, TX 77037

WB

CAGE code: 39782

WALZ & KRENZER INC.

DBA MAPECO PRODUCTS DIV MAPECO
PRODUCTS
91 WILLENBROCK RD STE B4
OXFORD, CT 06478-1036

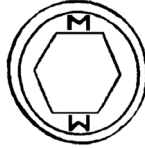

CAGE code: 87045

WARREN PUMPS LLC.

DIVISION OF COLFAX CORPORATION
P.O. BOX 969
82 BRIDGES AVENUE
WARREN, MA 01083



CAGE code: 63857

WATERBURY BUCKLE CO.

952 S. MAIN STREET
WATERBURY, CT 06721



CAGE code: 82399

WAYNE BOLT & NUT CO., INC.

14471 LIVERNOIS AVE.
DETROIT, MI 48238-2097



CAGE code: 5Z751

WEAVER MANUFACTURING, INC.

1005 E. 17TH STREET
WICHITA, KS 67214



CAGE code: 16345

WEBLUK MACHINE CORP.

4959 COMMERCE PARKWAY
WARRENSVILLE HEIGHTS, OH 44128

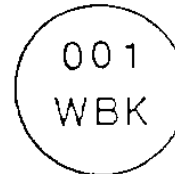

CAGE code: 0C095

WELTER GMBH & CO. KG

BONNER RING 49
P. O. BOX 1311
ERFTSTADT, GERMANY 50374

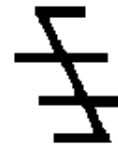

CAGE code: C3486

WELTON ROLLED THREAD CORP.
1818 GLENDALE BLVD
LOS ANGELES, CA 90026



CAGE code: 27871

WEST SHORE ENGINEERING, INC.
2201 CELSIUS AVE.
UNIT D
OXNARD, CA 93030



CAGE code: 77KD7

WESLOK
4160 S. 13TH STREET
MILWAUKEE, WI 53221



CAGE code:

WEST TENNESEE LIONS BLIND IND. INC.
P.O. BOX 2175
346 ST PAUL AVENUE
MEMPHIS, TN 38101-2175

(See A P MILLS INDUSTRIES FOR THE BLIND)



CAGE code: 6Y776

WEST COAST AEROSPACE, INC.
24224 BROAD STREET
CARSON, CA 90745

Plant
220 WEST E. STREET
WILMINGTON, CA 90744



CAGE code: 60516

WESTERN PACIFIC ENTERPRISES, W.P.E. INC.
8110 REMMET AVE.
CANOGA PARK, CA 91304



CAGE code: 5N444

WESTERN SCREW MACHINE PRODUCTS, INC.

CUTTING EDGE MACHINING
1625 LINDA WAY
SPARKS, NV 89431

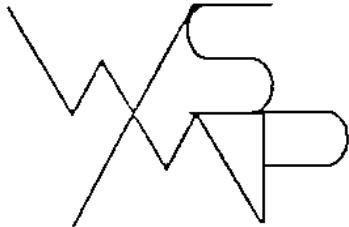

CAGE code: OZV72

WESTERN SKY INDUSTRIES, INC.

DIVISION OF ATLAS CORP.
21300 CLOUDWAY
HAYWARD, CA 94545



CAGE code: 04169

WESTFIELD FASTENERS

202 UNION STREET
WESTFIELD, MA 01085



CAGE code:

WESTLAND STEEL PRODUCTS, LTD.

P. O. BOX 1052
165 CORDITE ROAD
WINNIPEG, MANITOBA, CANADA R3C 2X4



CAGE code: 0NWX5

WESTWOOD PRECISION, INC.

7509 HARDESON ROAD
EVERETT, WA 98203

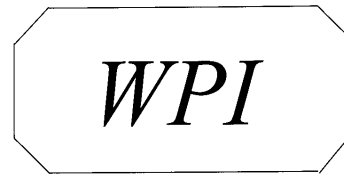

CAGE code: 0PL34

WHAIL BOLT IND. CO., LTD

779-2, WONSI-DONG, ANSAN
KYUGKI-DO, KOREA

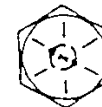

GRADE 5 HEX
CAP SCREWS

GRADE 8 HEX
CAP SCREWS

CAGE code:

WHELAN MACHINE & TOOL CO.

134 ROCHESTER DR
LOUISVILLE, KY 40214-2681

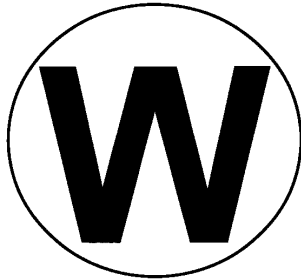

Aerial-Bold letter "W" enclosed with a circle

CAGE code: 0MB07

WHITNEY SCREW CORP.

P.O. BOX 784
14A BROAD STREET
NASHUA, NH 03061



CAGE code: 87181

WHITTET-HIGGINS CO.

33 HIGGINSON AVE.
CENTRAL FALLS, RI 02863



CAGE code: 79568

WIGLEY MACHINE COMPANY

2007 WEST 2ND AVENUE
CORSICANA, TX 75110



CAGE code: 0UBT5

WILHELM SCHUMACHER SCHRAUBEN-FABRIK GmbH

POSTFACH 12 80,
AM PREIST 5
D-5912 HILCHENBACH,
GERMANY



Hex head
screws and
bolts



Machining screws
and other
products

CAGE code:

WILLIAM'S MACHINE & FABRICATION, INC.

P.O. BOX 22235
700 DELAY DRIVE
EUGENE, OR 97402

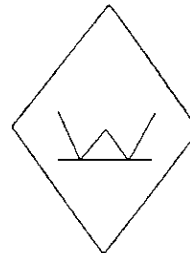

CAGE code: 0NNK2

WIL-NIC

E D R INDUSTRIES INC DBA WIL-NICO
100 COMMERCIAL STREET
FREEPORT, NY 11520-2832



CAGE code: 8P827

WILSON-GARNER CO.

40935 PRODUCTION DR
HARRISON TOWNSHIP, MI 48045-1351

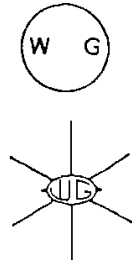

CAGE code: 7E548

WILT PRECISION PRODUCTS

P.O. BOX 69
DOVER, PA 17315



CAGE code: 34282

WINEGAR, INC.

1209 SOUTH STATE STREET
WASECA, MN 56093



CAGE code: 3F2Y1

**WINKER HERMAN GMBH & CO.
KGMETALLWARENFABRIK**

P.O. BOC 1356
DELLINGER WEG 1
SPAICHINGEN, 78549 GERMANY

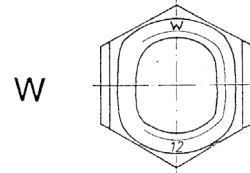

CAGE code: D2362

WINSLOW AUTOMATICS, INC.

23 ST. CLAIR AVENUE
NEW BRITAIN, CT 06051



CAGE code: 7W515

WITTEN COMPANY, INC

P.O. BOX269
OWASSO, OK 74055

Plant
8199 N. 116TH E. AVE.
OWASSO, OK 74055



CAGE code: 0JHK5

WODIN, INC.

5441 PERKINS ROAD
BEDFORD HEIGHTS, OH 44146



CAGE code: 5V334

WOLSTENHOLME MACHINE

DBA WM ROBOTS
3075 ADVANCE LANE
COLMAR, PA 18915-9420



CAGE code: 68531

WOLTERS GMBH

OTTILIENSTR 19
D-GUTERSLOH
WEST GERMANY



WH

LE

CAGE code:

WOLVERINE MACHINE PRODUCTS CO.

P.O. BOX 209
319 COGSHALL ST.
HOLLY, MI 48442

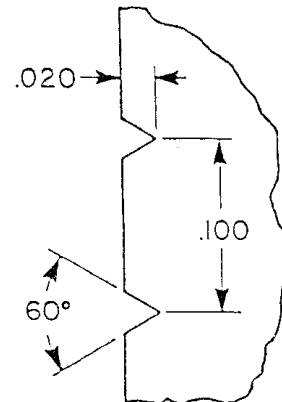

CAGE code: 2T549

WOLVERINE NUT CO.

6556 EAST McNICHOLS
DETROIT, MI 48212

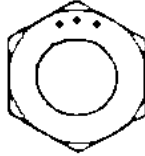

3 dots, centered on corner,
equally spaced

CAGE code: 87824

WORTHEY MACHINE

P. O. BOX 70
3000 US HWY 72 E
PAINT ROCK, AL 35764-0070

WSMP

CAGE code: 5S740

**WROUGHT WASHER MANUFACTURING
INC.**

2100 SOUTH BAY STREET
MILWAUKEE, WI 53207



Marking for medium carbon heat treated washers compatible
with Grade 5 and Grade 8 bolts.

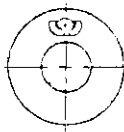

Marking for low carbon washers.

CAGE code: 79807

WYANDOTTE INDUSTRIES, INC.

4625 13TH STREET
WYANDOTTE, MI 48192

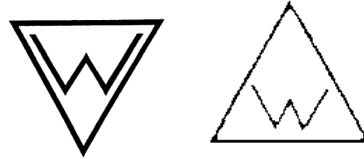

CAGE code: 54151

WYNNSON ENTERPRISES, INC.

P. O. BOX 440
12039 HWY 239-431 N.
MERIDIANVILLE, AL 35759-1201



CAGE code: 39484

X-TECH INNOVATIONS INCORPORATED

424 18th AVENUE
ROCKFORD, IL 61104



CAGE CODE: 5ZZR7

XCEL MFG., INC.

P.O. BOX 239
ELYRIA, OH 44036

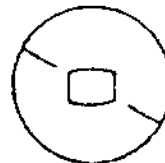

CAGE code:

Y2K MACHINE SHOP
106 WALSH ROAD
SAN ANTONIO, TX 78224

Y 2 K

CAGE code: 1TMD7

YATES TOOL, INC.
2425 MEDINA ROAD
MEDINA, OH 44256

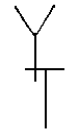

Either electroetched, steel stamped,
vibropeened, or ink stamped

CAGE code: IDV02

YEAGER MANUFACTURING CORP.
DBA CUMMINS AEROSPACE

CA

see CUMMINS AEROSPACE

CAGE code: 31788

YOUNG ENGINEERS INC, THE
25841 COMMERCENTRE DRIVE
LAKE FOREST, CA 92630-8812

TYE

CAGE code: 56958

YOW MENG I INDUSTRIAL CO., LTD.
NO. 180 WUN-AN RD., EAST SEC.
MI-TUO HSIANG 82704
KAOHSIUNG HSIEN,
TAIWAN, R.O.C.



CAGE code:

Z & B GENERAL MACHINE
569 HULMEVILLE AVE.
PENNDL, PA 19047



CAGE code: 5T735

ZAMON CO., INC.

ENDICOTT ST., BLDG. 23
NORWOOD, MA 02062



CAGE code: 5Z471

ZENEX CORPORATION

850 ELMHURST RD.
ELK GROVE VILLAGE, IL 60007

ZENEX

CAGE code: 25723

ZERO PRODUCTS , INC.

219 BAYWOOD ST
HOUSTON, TEXAS 77011



Z

CAGE code: 3JC57

MIL-HDBK-57 FASTENER IDENTIFICATION SYMBOL CONFIRMATION

Complete this form and email to aviationlogo@dla.mil, along with a separate PDF file containing artwork of your fastener head marking.

(Company name as it will appear in the listing) _____

(Department, Division, etc., if it is to appear in the listing)

Corporate/Mailing Address	Plant Location (if different)
_____	_____
_____	_____
_____	_____
_____	_____

Our Company is a fastener manufacturer YES () NO ()

NOTE: MIL-HDBK-57 requires the sources listed to have an inherent capability to manufacture fasteners out of raw material.

Telephone: _____ FAX Number: _____

Contact Name: _____ CAGE code: _____

Title: _____ DUNS Number: _____

Email: _____ Website URL: _____

1. Fastener head marking artwork that is submitted electronically will be provided in a PDF file. A resolution of 100 dpi (dots per inch) minimum will be used for artwork that is scanned. Provide only one marking per file submitted. Include the company name and plant location in this file, along with a written description of the fastener head marking. (For example "the script upper case letter A", or "the number 3 enclosed by a circle.")
2. If your company has plants in various locations, please provide DLA Aviation with the symbol(s) used for each location, as well as the CAGE code, point of contact, and phone number for each point of contact.
NOTE: Active manufacturing plants will have one unique address per cage code.
3. All information must be supplied in the English language.
4. Submit this form and artwork to aviationlogo@dla.mil.

NOTE: We encourage you to duplicate this form and forward it to your various plants, as necessary.

SUBMITTED BY: _____

TITLE: _____

DATE (mm/dd /yyyy): _____

PLEASE SUBMIT LOGO (HEAD MARKING) ON A SEPARATE SHEET.

MIL-HDBK-57J (GS7)

CONCLUDING MATERIAL

Preparing Activity:
DLA – GS7

(Project No. 53GP-2022-002)

NOTE: The activities listed above were interested in this document as of the date of this document. Since organizations and responsibilities can change, you should verify the currency of the information above using the ASSIST Online database at <https://assist.dla.mil>.