

**METRIC**

**DOD-HDBK-791 (AM)**

17 MARCH 1988

**MILITARY HANDBOOK**

# **MAINTAINABILITY DESIGN TECHNIQUES**

**METRIC**



**NO DELIVERABLE DATA REQUIRED  
BY THIS DOCUMENT**

**AREA MISC**

DISTRIBUTION STATEMENT A. APPROVED FOR PUBLIC RELEASE; DISTRIBUTION IS UNLIMITED.

**DEPARTMENT OF DEFENSE  
WASHINGTON, DC 20301**

**Maintainability Design Techniques**

1. This standardization handbook was developed by the School of Engineering & Logistics with the assistance of other organizations within the Department of the Army and industry.

2. This document supplements departmental manuals, directives, military standards, etc., and provides basic information on the design of equipment so that the equipment can be (a) serviced efficiently and effectively if servicing is required and (b) repaired efficiently and effectively if it should fail. The handbook -by text, illustrations, tables, and examples embraces information on the extent and nature of the maintenance problem as it exists today and the principles and techniques, if included in future designs, will reduce the problem. Designers will find this handbook an invaluable aid in applying the principles of maintainability engineering.

3. Beneficial comments (recommendations, additions, deletions) and any pertinent data that may be used in improving this document should be addressed to the Commandant, School of Engineering and Logistics, AI-TN: AMXMC-SEL-E, Red River Army Depot, Texarkana, TX 75507-5000.

## FOREWORD

The purpose of this handbook is to provide Army design engineers with guidelines to assist them in incorporating maintainability into Army materiel early in research and development. Information collected from maintenance records provides practical examples—good and bad—that illustrate the design principles that result in maximum maintainability. The designer can use these principles to build maintainability into materiel and thereby contribute substantially to solving the Army's maintenance problem.

Chapter 1 is an introduction to the principle of maintainability, its importance, and methods of achieving it. The following 10 chapters—simplification, standardiza-

tion and interchangeability, accessibility, modularization, identification and labeling, testability and diagnostic techniques, preventive maintenance, human factors, and environmental factors—describe in detail their role in achieving the maintainability principle.

This handbook was developed under the auspices of the Army Materiel Command's Engineering Design Handbook Program, under the direction of the US Army Management Training Activity. The handbook was prepared under the direction of and edited by the Research Triangle Institute under Contract No. DAAG-34-73-C-0051 .

**This page intentionally left blank.**

## CONTENTS

<i>Paragraph</i>		<i>Page</i>
	LIST OF ILLUSTRATIONS .....	xi
	LIST OF TABLES .....	xiii
	LIST OF ABBREVIATIONS AND ACRONYMS .....	xiv
 CHAPTER 1 INTRODUCTION		
1-1	INTRODUCTION .....	1-1
1-1	MAINTAINABILITY VS MAINTENANCE .....	1-1
1-3	MEASURES OF MAINTAINABILITY .....	1-2
1-3.1	GENERAL .....	1-2
1-3.2	QUANTITATIVE MAINTAINABILITY INDICES .....	1-4
1-4	MAINTAINABILITY PROGRAM .....	1-5
1-4.1	OBJECTIVES .....	1-5
1-4.2	MAINTAINABILITY PLAN .....	1-6
1-4.3	VERIFICATION, DEMONSTRATION, AND EVALUATION OF MAINTAINABILITY REQUIREMENTS .....	1-7
1-5	FEATURES TO FACILITATE MAINTAINABILITY .....	1-7
	REFERENCES .....	1-8
	BIBLIOGRAPHY .....	1-8
 CHAPTER 2 SIMPLIFICATION		
2-1	INTRODUCTION .....	2-1
2-2	DESIGN TECHNIQUES .....	2-1
2-2.1	COORDINATION OF EQUIPMENT AND JOB DESIGN .....	2-2
2-2.2	REDUCTION OF PARTS .....	2-2
2-2.3	VALUE ENGINEERING .....	2-2
2-2.4	CONSOLIDATION OF FUNCTIONS .....	2-2
2-2.5	IMPROVED ACCESS TO PARTS .....	2-3
2-2.6	STREAMLINED MAINTENANCE PROCEDURES .....	2-3
2-2.6.1	Part Configuration .....	2-3
2-2.6.2	Scheduling of Maintenance .....	2-4
2-2.6.3	Simplified Diagnostic Techniques .....	2-4
2-2.7	SOFTWARE MAINTENANCE .....	2-4
2-3	EXAMPLES OF COMPLEX MODULES REDESIGNED FOR SIMPLICITY .....	2-4
2-3.1	UH-60A HELICOPTER .....	2-4
2-3.2	155-mm HOWITZER .....	2-5
2-2.3	M230 GUN .....	2-5
2-3.4	INFRARED SUPPRESSOR .....	2-5
2-4	SIMPLIFICATION CHECK LIST .....	2-5
	REFERENCES .....	2-7
	BIBLIOGRAPHY .....	2-7
 CHAPTER 3 STANDARDIZATION AND INTERCHANGEABILITY		
3-1	LIST OF SYMBOLS .....	3-1
3-1	INTRODUCTION .....	3-1
3-2	STANDARDIZATION .....	3-1
3-2.1	DESIGN GOALS AND PRINCIPLES .....	3-2
3-2.2	ADVANTAGES .....	3-2
3-3	INTERCHANGEABILITY .....	3-2
3-3.1	GENERAL .....	3-2
3-3.2	RATIONALIZATION, STANDARDIZATION, AND INTEROPERABILITY (RSP) PROGRAM .....	3-3
3-3.3	DESIGN PRINCIPLES .....	3-3
3-3.4	ADVANTAGES .....	3-3

**This page intentionally left blank.**

## CONTENTS (cont'd)

<i>Paragraph</i>		<i>Page</i>
4-7	ACCESSIBILITY CHECKLIST .....	4-28
	REFERENCES .....	4-31
	BIBLIOGRAPHY .....	4-31

## CHAPTER 5 MODULARIZATION

5-1	INTRODUCTION .....	5-1
5-2	ADVANTAGES .....	5-1
5-3	THROWAWAY MAINTENANCE .....	5-2
5-3.1	GENERAL .....	5-2
5-3.2	ADVANTAGES .....	5-2
5-3.3	HAZARDS .....	5-3
5-4	SOFTWARE MODULES .....	5-3
5-5	DESIGN CRITERIA .....	5-3
5-5.1	MODULARIZATION VERSUS PIECE-PART DESIGN .....	5-3
5-5.1.1	General "Module Versus Piece-Part" Criteria .....	5-4
5-5.1.2	General Module Criteria .....	5-4
5-5.1.3	Throwaway (Discard-at-Failure) Criteria .....	5-4
5-5.2	FUNCTIONAL GROUPING FOR MODULARIZATION .....	5-4
5-5.2.1	Logical Flow Grouping .....	5-4
5-5.2.2	Circuit Grouping .....	5-5
5-5.2.3	Component Grouping .....	5-5
5-5.2.4	Standard Construction .....	5-5
5-5.2.5	Frequency Grouping .....	5-5
5-5.2.6	Evaluation of Grouping Methods .....	5-5
5-5.3	TYPICAL DESIGN GUIDELINES .....	5-6
5-6	EXAMPLES .....	5-6
5-6.1	ELECTRONIC AND ELECTRICAL EQUIPMENT .....	5-6
5-6.2	MISSILES AND ROCKETS .....	5-9
5-6.3	TANK-AUTOMOTIVE EQUIPMENT .....	5-9
5-6.3.1	Fuel Injection .....	5-9
5-6.3.2	Engine Modules .....	5-9
5-6.3.3	Total Vehicle .....	5-9
5-6.4	MODULARIZATION IN ARMAMENT .....	5-9
5-6.4.1	Feed and Eject Module .....	5-13
5-6.4.2	Complete Gun Modularization .....	5-13
5-5.5	HELICOPTER ENGINE .....	5-13
5-7	MODULARIZATION CHECKLIST .....	5-16
	REFERENCES .....	5-17
	BIBLIOGRAPHY .....	5-17

## CHAPTER 6 IDENTIFICATION AND LABELING

6-1	INTRODUCTION .....	6-1
6-2	BASIC CHARACTERISTICS .....	6-2
6-3	TYPES AND USES OF IDENTIFICATION.....	6-2
6-3.1	GENERAL .....	6-2
6-3.2	EQUIPMENT IDENTIFICATION .....	6-2
6-3.3	EQUIPMENT FUNCTIONAL AND/OR INSTRUCTIONAL MARKINGS .....	6-4
6-3.4	HAZARDOUS CONDITION MARKINGS .....	6-4
6-3.5	PART IDENTIFICATION .....	6-4
6-4	METHODS OF LABELING .....	6-5
6-4.1	INK STAMPING .....	6-6
6-4.2	STEEL STAMPING .....	6-6
6-4.3	ENGRAVING .....	6-6
6-4.4	MOLDING-IN .....	6-6

**CONTENTS (cont'd)**

<i>Paragraph</i>		<i>Page</i>
6-4.5	DECALCOMANIA TRANSFER .....	6-6
6-4.6	STENCILING .....	6-6
6-4.7	PHOTOETCHING .....	6-7
6-4.8	METAL PLATES .....	6-7
6-4.9	TAGS .....	6-7
6-4.10	PHOTOCONTACT .....	6-7
6-4.11	SCREEN PRINTING .....	6-7
6-4.12	ADHESIVE-BACKED LABELS .....	6-7
6-5	LABELING .....	6-7
6-5.1	LABEL CONTENT .....	6-7
6-5.2	LABEL PLACEMENT AND POSITIONING .....	6-9
6-5.3	LABEL DESIGN .....	6-11
6-5.3.1	Color Contrast and Background .....	6-11
6-5.3.2	Letter and Numeral Size and Font .....	6-12
6-5.3.2.1	Type Style .....	6-12
6-5.3.2.2	Letter or Numeral Width .....	6-12
6-5.3.2.3	Character Stroke Width .....	6-12
6-5.3.2.4	Stroke Continuity .....	6-12
6-5.3.2.5	Character Spacing .....	6-12
6-5.3.2.6	Word and Line Spacing .....	6-12
6-5.3.2.7	Character Height .....	6-12
6-5.4	METHOD OF APPLICATION .....	6-14
6-6	COLORS FOR LABELS AND SIGNS .....	6-14
6-7	IDENTIFICATION CHECKLISTS .....	6-17
	REFERENCES .....	6-19
	BIBLIOGRAPHY .....	6-19

**CHAPTER 7  
TESTABILITY AND DIAGNOSTIC TECHNIQUES**

7-1	INTRODUCTION .....	7-1
7-2	TESTABILITY .....	7-1
7-2.1	GENERAL .....	7-1
7-2.2	TESTABILITY ANALYSIS .....	7-1
7-2.3	INTERFACE RELATIONSHIPS .....	7-2
7-2.4	CHARACTERISTICS EXTERNAL TO BIT .....	7-3
7-3	DIAGNOSTICS .....	7-5
7-3.1	GENERAL .....	7-5
7-3.2	DESIGN NEEDS .....	7-5
7-3.3	DEVELOPMENT AND DEMONSTRATION TESTING .....	7-5
7-3.4	DIAGNOSTICS FOR MECHANICAL SYSTEMS .....	7-6
7-3.4.1	Condition Monitoring of Mechanical Systems .....	7-6
7-3.4.2	Nondestructive Evaluation .....	7-7
7-3.5	DIAGNOSTIC TECHNIQUES .....	7-7
7-3.5.1	Importance .....	7-7
7-3.5.2	Types of Diagnostic Techniques .....	7-7
7-3.5.2.1	Logic Flow .....	7-8
7-3.5.2.2	Automatic Test Equipment .....	7-8
7-3.5.2.3	Built-In Test Equipment .....	7-9
7-3.5.3	Artificial Intelligence .....	7-9
7-4	FUNCTIONAL TESTS .....	7-10
7-4.1	TYPES .....	7-10
7-4.1.1	Fault Localization, Isolation, and Prediction .....	7-10
7-4.1.2	Verification Testing .....	7-10
7-4.1.3	Testing for Hidden Faults .....	7-10
7-4.2	PERCENTAGE OF FAILURES DETECTABLE .....	7-10
7-5	DIAGNOSTIC EQUIPMENT DESIGN CONSIDERATIONS .....	7-10

## CONTENTS (cont'd)

<i>Paragraph</i>		<i>Page</i>
7-5.1	CLASSIFICATION .....	7-11
7-5.2	SNEAK CIRCUITS .....	7-11
7-5.3	BUILT-IN TEST EQUIPMENT VERSUS AUTOMATIC TEST EQUIPMENT .....	7-11
7-5.4	DIAGNOSTIC SOFTWARE .....	7-12
7-5.5	TEST POINT IDENTIFICATION .....	7-12
7-5.6	TEST SEQUENCE CONSIDERATIONS .....	7-13
7-5.7	SELECTION OF TRANSDUCER OR SENSOR .....	7-16
7-5.8	STIMULI SELECTION .....	7-16
7-5.9	OUTPUT FORMAT .....	7-16
7-5.10	DIAGRAMS .....	7-17
7-6	EXAMPLES .....	7-17
7-6.1	LIKELIHOOD ANALYSIS COMPUTER PROGRAM .....	7-17
7-6.2	ADVANCED ATTACK HELICOPTERS .....	7-17
7-6.3	T700 GAS TURBINE .....	7-20
7-7	CHECKLISTS .....	7-20
	REFERENCES .....	7-27

### CHAPTER 8 PREVENTIVE MAINTENANCE

8-0	LIST OF SYMBOLS .....	8-1
8-1	INTRODUCTION .....	8-1
8-2	RELIABILITY CENTERED MAINTENANCE .....	8-2
8-2.1	GENERAL .....	8-2
8-2.2	OBJECTIVE .....	8-2
8-2.3	RELIABILITY CENTERED MAINTENANCE LOGIC .....	8-3
8-2.4	DISPOSITION OF RELIABILITY CENTERED MAINTENANCE ANALYSIS .....	8-3
8-3	PREVENTIVE MAINTENANCE EVALUATION PARAMETERS AND TRADE-OFFS .....	8-3
8-3.1	AVAILABILITY .....	8-3
8-3.2	COST OF OWNERSHIP .....	8-6
8-4	DESIGN CONSIDERATIONS .....	8-7
8-4.1	LUBRICATION .....	8-7
8-4.1.1	Oiling and Greasing .....	8-7
8-4.1.2	Army Oil Analysis Program (AOAP) .....	8-10
8-4.2	FILLING AND DRAINING .....	8-10
8-4.2.1	General .....	8-10
8-4.2.2	Filling Requirements .....	8-10
8-4.2.3	Draining Requirements .....	8-13
8-4.3	CLEANING AND PRESERVING .....	8-15
8-4.3.1	Cleaning .....	8-15
8-4.3.2	Preserving .....	8-15
8-4.4	MOISTURE PROTECTION .....	8-16
8-4.5	ADJUSTMENT AND ALIGNMENT .....	8-16
8-5	PREVENTIVE MAINTENANCE AND SERVICING DESIGN CHECKLIST .....	8-17
	REFERENCES .....	8-19

### CHAPTER 9 HUMAN FACTORS

9-1	INTRODUCTION .....	9-1
9-2	ANTHROPOMETRY (BODY MEASUREMENTS) .....	9-2
9-2.1	SOURCES OF INFORMATION .....	9-2
9-2.2	MEASUREMENTS .....	9-2
9-3	HUMAN STRENGTH AND HANDLING CAPACITY .....	9-4
9-4	HUMAN SENSORY CAPABILITIES .....	9-4
9-4.1	SIGHT .....	9-4
9-4.2	HEARING .....	9-10
9-4.3	TOUCH .....	9-10

**CONTENTS (cont'd)**

<i>Paragraph</i>		<i>Page</i>
9-5	PSYCHOLOGICAL FACTORS .....	9-13
9-5.1	MOTIVATION AND TRAINING .....	9-13
9-5.2	CAPABILITY .....	9-13
9-5.3	HUMAN ERROR .....	9-14
9-5.3.1	General .....	9-14
9-5.3.2	Causes .....	9-14
9-5.3.3	Contributing Factors .....	9-14
9-5.3.4	Quantification .....	9-15
9-6	PHYSICAL FACTORS .....	9-15
	REFERENCES .....	9-17
	BIBLIOGRAPHY .....	9-17

**CHAPTER 10  
ENVIRONMENTAL FACTORS**

10-1	INTRODUCTION .....	10-1
10-2	ENVIRONMENTS .....	10-2
10-2.1	NATURAL, INDUCED, AND COMBINED .....	10-2
10-2.2	WARTIME ENVIRONMENTS .....	10-2
10-2.2.1	Chemical .....	10-3
10-2.2.2	Nuclear .....	10-3
10-2.2.3	Electromagnetic Radiation .....	10-3
10-2.2.4	Enemy and Friendly Fire .....	10-5
10-3	EFFECTS OF ENVIRONMENTS .....	10-5
10-3.1	EFFECTS ON PERSONNEL .....	10-5
10-3.1.1	Temperature .....	10-5
10-3.1.1.1	Effective Temperature .....	10-6
10-3.1.1.2	Wet-Bulb Global Temperature .....	10-6
10-3.1.1.3	Windchill Index .....	10-6
10-3.1.1.4	Guidelines for Maintenance Operations in Extreme Climates .....	10-6
10-3.1.2	Other Climatic Factors .....	10-10
10-3.1.3	Whole-Body Vibration .....	10-10
10-3.1.4	Terrain Factors .....	10-12
10-3.2	EFFECTS ON EQUIPMENT .....	10-12
10-3.2.1	General Considerations .....	10-13
10-3.2.1.1	Moisture Protection .....	10-13
10-3.2.1.2	Desert Regions .....	10-14
10-3.2.1.3	Arctic Regions .....	10-14
10-3.2.1.4	Vibration .....	10-15
10-3.2.1.5	Shock .....	10-15
10-3.2.1.6	Acceleration .....	10-15
10-3.2.1.7	Nuclear Radiation .....	10-15
10-3.2.1.8	Electromagnetic Radiation Effects .....	10-17
10-3.2.2	Summary of Environmental Effects .....	10-18
	REFERENCES .....	10-26
	GLOSSARY .....	G-1
	INDEX .....	I-1

## LIST OF ILLUSTRATIONS

<i>Figure No.</i>	<i>Title</i>	<i>Page</i>
1-1	Distribution of Maintenance Time .....	1-3
1-2	Maintenance Time Distribution and Maintainability Function .....	1-4
1-3	Maintainability Level of Effort .....	1-5
2-1	Comparison of the M188 20-mm Gattling Gun to the M230 30-mm Gun .....	2-5
2-2	Simple Self-Powered Feed System in M230 Gun .....	2-6
3-1	Typical Maintenance Distributions .....	3-5
3-2	Example for Selection of Parts for Program Parts Selection List (PPSL) .....	3-7
3-3	NSN Configuration .....	3-9
3-4	TM DE Selection Flow Chart .....	3-11
4-1	Types of Covers and Accesses .....	4-3
4-2	Examples of Spring Loaded Sliding and Hinged Access Doors .....	4-4
4-3	Sliding Access Door With Handle .....	4-5
4-4	Examples of Rollout, Rotatable, and Slide-Out Drawers .....	4-5
4-5	Example of Access to Permit Easy Removal of Component .....	4-5
4-6	Methods of Securing Hinged Covers .....	4-6
4-7	Avoidance of Structural Members .....	4-6
4-8	Component Mounting Positions .....	4-7
4-9	Clearance for Nuts and Bolts .....	4-8
4-10	Common Orientation of Tube Sockets to Facilitate Tube Replacement .....	4-8
4-11	Simultaneous Maintenance Actions on a Modern Helicopter .....	4-9
4-12	Frequency With Which Hand Tools Are Used at Least Once in 427 Maintenance Tasks on Electronic Equipment .....	4-11
4-13	One-Hand Access Openings .....	4-12
4-14	Access-Opening Dimensions .....	4-13
4-15	Gloved-Hand Dimensions for 95th Percentile Man .....	4-15
4-16	Foldout Construction for Electronic Chassis .....	4-16
4-17	Hinged Assemblies Braced in "Out" Position Leave Both Hands Free .....	4-16
4-18	Stands for Maintenance as a Part of Chassis Will Prevent Damage to Parts .....	4-16
4-19	Side-Alignment Brackets Facilitate Correct Mounting .....	4-16
4-20	Handle Dimensions .....	4-17
4-21	Handles Facilitate Removal of Covers and Carrying of Units .....	4-18
4-22	Cases Should Lift Off Units .....	4-18
4-23	Additional Use of Handles .....	4-18
4-24	U-Type Lugs Facilitate Repairs .....	4-18
4-25	Spacing Wire Leads Facilitates Repairs .....	4-18
4-26	Terminals Should Be Long Enough to Prevent Damage to Insulation During Repairs .....	4-18
4-27	Route Cables So They Are Not Likely to Be Walked On .....	4-19
4-28	Route Cabling to Avoid Sharp Bends .....	4-19
4-29	Methods for Recoiling Service Loops in Sliding Chassis .....	4-19
4-30	Connectors Should Be Arranged So That They Can Be Grasped Firmly for Disconnection .....	4-20
4-31	Fastener Examples .....	4-21
4-32	Mating Surface of Component Trailers .....	4-22
4-33	Physical Stability for Maintenance Stands .....	4-22
4-34	Corner Stress Cracks .....	4-24
4-35	Provide Access Door for Each Fuel Cell .....	4-25
4-36	Mount Stator and Rotor Blades to Facilitate Removal of Individual Blades .....	4-27
5-1	Design for Functional Utilization That Corresponds to Modularization .....	5-5
5-2	Modules in Target Acquisition and Designation System (TADS) .....	5-7
5-3	TADS Turret Assembly—Day Side Modules .....	5-8
5-4	M1 Turbine Engine Modules for Tank .....	5-10
5-5	Fittings and Rigging for Rear Engine Module .....	5-11
5-6	Modular Vehicle Design .....	5-12
5-7	Data Output Balance Sheet .....	5-13
5-8	CHAIN GUN <sup>®</sup> Bolt Assembly and Drive Train Modules .....	5-14
5-9	5.56-mm M231 Submachine Gun .....	5-15
5-10	Modules for 5.56-mm M231 Submachine Gun .....	5-15
6-1	Example of Identification Plate .....	6-3

## LIST OF ILLUSTRATIONS (cont'd)

<i>Figure No.</i>	<i>Title</i>	<i>Page</i>
6-2	Example of Warranty Marking .....	6-3
6-3	Placement of Labels for Hazardous Tasks .....	6-5
6-4	Examples of Informative Labels .....	6-5
6-5	Example of Label Brevity .....	6-8
6-6	Example of Step-by-Step Instructions .....	6-8
6-7	Example of Horizontal Labels to Facilitate Reading .....	6-9
6-8	Examples of Preferred Arrow Shapes .....	6-9
6-9	Example of Consistent Positioning of Labels .....	6-9
6-10	Examples of Method of Positioning Labels to Avoid Masking by Control Handles .....	6-10
6-11	Example of Label Placement Which Can Result in Upside-Down Position .....	6-10
6-12	Example of a Poor Placement of Label .....	6-10
6-13	Example of Label Location for a Panel .....	6-10
6-14	Example of Placement of Label on Vertical Surface .....	6-11
6-15	Labels for Valve Controls .....	6-11
6-16	Example of a Caution Sign .....	6-11
6-17	Example of a Danger Sign .....	6-11
6-18	Character Height Criteria for Instruments, Panels, and Equipment Viewed in Close Proximity Under Various Illumination Levels .....	6-13
6-19	Character Height for Viewing Signs at Extended Distances .....	6-14
6-20	Label Size-Hierarchy Example for Equipment, Panel, Subpanel, and Component Identification .....	6-15
6-21	Radio Frequency Radiation Hazard Warning Symbol .....	6-16
6-22	Nuclear Radiation Hazard Warning Symbol .....	6-17
7-1	Liquid Coolant Subsystem Showing Transducers and Parameters of Interest .....	7-12
7-2	Test Sequence for Liquid Coolant Subsystem .....	7-14
7-3	Logic Test Sequence for Track Radar Transmitter .....	7-15
7-4	Data Analysis Methodology for Vibration Signals .....	7-18
7-5	Design Approach Fault Detection and Location Subsystem .....	7-19
7-6	Redundant FBW Stabilator .....	7-20
8-1	Relation of Equipment Status on Availability .....	8-2
8-2	RCM Analysis Process .....	8-4
8-3	Logistical Support Analysis Record (LSAR) Data Record B .....	8-5
8-4	Typical Lubrication Fittings .....	8-8
8-5	Bearing Lubrication Methods .....	8-9
8-6	Example of a Lubrication Order .....	8-11
8-7	Oil Level Sight Plugs .....	8-13
8-8	Drain Plug Heads .....	8-13
8-9	Electromotive Series .....	8-14
9-1	US Army Basic Trainees (1966): Breadth & Circumference Measurements .....	9-3
9-2	Arm, Hand, and Thumb-Finger Strength (5th Percentile Man) .....	9-5
9-3	Visual Field .....	9-7
9-4	Permissible Distance Between Speaker and Listener for Specified Voice Levels and Ambient Noise Levels .....	9-12
9-5	Easily Recognizable Knob Shapes .....	9-11
10-1	Error Increase Due to Rise in Effective Temperature .....	10-6
10-2	Deriving Effective Temperature .....	10-7
10-3	Summer and Winter Comfort Zones and Thermal Tolerances for inhabited Compartments .....	10-8
10-4	Windchill Chart .....	10-9
10-5	Vibration Criteria for Longitudinal and Transverse Directions With Respect to Body Axes .....	10-11
10-6	90% Motion Sickness Protection Limits for Human Exposure to Very Low Frequency Vibration .....	10-12
10-7	Reduction in Insulation Resistance of Typical Electronic Components Exposed for Five Months in Tropical Jungle .....	10-13

## LIST OF TABLES

<i>Table No.</i>	<i>Title</i>	<i>Page</i>
1-1	Application Matrix .....	1-6
2-1	Simplification Checklist .....	2-7
3-1	Standardization Checklist .....	3-12
3-2	Interchangeability Checklist .....	3-12
4-1	Recommended Equipment Accesses .....	4-4
4-2	Aperture Dimensions for Regularly Clothed Technician .....	4-12
4-3	List of Top Ten Replacement Parts by Frequency of Occurrence .....	4-23
4-4	List of Top Ten Replacement Parts by Man-Hours to Replace .....	4-24
4-5	Reciprocating Engine Accessories That Should Be Accessible for Inspection, Cleaning, Adjustment, Removal, and Replacement .....	4-26
4-6	Turbine Engine Accessories That Should Be Accessible for Inspection, Cleaning, Adjusting, Removal, and Replacement .....	4-27
4-7	Accessibility Checklist .....	4-29
5-1	Modularization Checklist .....	5-16
6-1	Close Equivalent Typefaces Suitable for Labeling .....	6-12
6-2	Best Color Combinations in Descending Order .....	6-15
6-3	Recognizable Colors .....	6-15
6-4	Identification Checklist .....	6-17
7-1	Typical Fault Insertion Test Results Versus Field Results .....	7-6
7-2	Typical Test Sequence .....	7-13
7-3	Diagnostic Portion of Operator's Checklist .....	7-18
7-4	Summary of Diagnostic Effectiveness for Gas Turbine Engine .....	7-21
7-5	Typical FMEA Backup .....	7-22
7-6	Elements for Fault Isolation .....	7-24
7-7	Testability Checklist .....	7-25
7-8	Diagnostic Checklist .....	7-26
8-1	Color Codes for Filler Caps .....	8-13
8-2	Drain Valves .....	8-13
8-3	Galvanic Series in Sea Water .....	8-14
8-4	Preventive Maintenance and Servicing Design Checklist .....	8-17
9-1	Sources of Anthropometric Data .....	9-2
9-2	Maximum Weight Limits .....	9-6
9-3	Illumination Requirement for Representative Tasks .....	9-7
9-4	Specific Task Illumination Requirements .....	9-8
9-5	Functional Evaluation of Audio Signals .....	9-10
9-6	When to Use Auditory or Visual Form of Presentation .....	9-11
9-7	Sound Intensity Levels .....	9-12
9-8	Human Error Rate Estimate Data .....	9-16
10-1	Relationship of Environmental Factors to Climate .....	10-1
10-2	Major Environmental Factors .....	10-3
10-3	Combination of Environmental Factors .....	10-4
10-4	Sound Levels Associated With Weapon Types .....	10-5
10-5	Human Reaction to Windchill Values .....	10-10
10-6	Temperature Extremes for Electronic Equipment Operating in a Desert Environment .....	10-14
10-7	Arctic Temperature Extremes for Electronic Equipment .....	10-14
10-8	Vibration-Induced Damage to Electrical and Electronic Equipment .....	10-16
10-9	Effect of Acceleration on Military Equipment .....	10-17
10-10	Environmental Requirements for Unsheltered Equipment .....	10-18
10-11	Summary of Major Environmental Effects .....	10-19
10-12	Failure Modes of Electronic Components .....	10-22

**This page intentionally left blank.**

## LIST OF ABBREVIATIONS AND ACRONYMS

AAH = advanced attack helicopter	GSE = ground support equipment
ACC = accessory module	HPR = human performance reliability
AI = artificial intelligence	HSM = hot section module
AIDAPS = automatic inspection, diagnostic, and prognostic system	IL = identification list
AIR = American Institute of Research	ILS = integrated logistics support
AM = amplitude modulation	IR = infrared
AMC = US Army Materiel Command	LOA = letter of agreement
AMDF = Army Master Data File	LRU = line-replaceable unit
AN = Army-Navy	LSAR = logistical support analysis record
AR = Army Regulation	$\tilde{M}_{ct}$ = median corrective maintenance time
AOAP = Army Oil Analysis Program	$M_{max,ct}$ = maximum time to repair
ATE = automatic test equipment	$\tilde{M}_{pt}$ = median preventive maintenance time
ATLAS = abbreviated test language for all systems	MANPRINT = manpower and personnel integration
BIF = built-in test	MAV = minimum acceptable value
BITE = built-in test equipment	MOS = military occupational specialty
BOC = best operating capability	MOSC = military occupational specialty code
CDRL = contract data requirements list	MPCAG = military parts control advisory group
CI = configuration item identifier	MS = military standard
CMF = career management fields	MTBDE = mean time between downtime events
CR = cathode ray	MTBF = mean time between failures
CSM = Cold Section Module	MTBM = mean time between maintenance
CW = continuous wave	MTBR = mean time between removal
DA = Department of the Army	MTTR = mean time to repair
DCP = Decision Coordinating Paper	MTTRS = mean-time-to-restore-system
DLSC = Defense Logistics Services Center	MWO = modification work order
DoD = Department of Defense	NATO = North Atlantic Treaty Organization
DODISS = Department of Defense Index of Specifications and Standards	NBC = nuclear, biological, and chemical
FCP = engineering change proposal	NCBC = National Codification Bureau Code
EDT = Executive Director for Test, Measurement, and Diagnostic Equipment	NDI = nondevelopmental items
EFH = engine flight hours	NICP = national inventory control point
EMP = electromagnetic pulse	NIIN = national item identification number
ENG = engine assembly	NSCM = NATO supply code for manufacturers
ET = effective temperature	NSN = national stock number
FD LS = Fault Detection, Location Subsystem	ORT = optical relay tube
FFT = Fast Fourier Transform	P/AM = phase-to-amplitude modulation
FMEA = failure modes and effects analysis	PCP = Parts Control Program
FMECA = failure mode, effects, and criticality analysis	PEF = personnel-equipment functional
FOD = foreign object damage	PIL = preferred items list
FSC = Federal supply classes	PMCS = preventive maintenance checks and services
FSCM = Federal supply code for manufacturers	PNVIS = pilot night vision sensor
FSN = Federal stock number	POM = program objective memorandum
GSA = General Services Administration	POST = power on self-test
	PPSL = program parts selection list
	PTM = power turbine module
	QPL = qualified products list

**LIST OF ABBREVIATIONS AND ACRONYMS (cont'd)**

RAM-D	reliability, availability, maintainability, and durability	LAMMS	The Army Maintenance Management System
RCM	= Reliability Centered Maintenance	THERP	technique for human error rate
RF	= radio frequency	TMDE	= test, measurement, and diagnostic equipment
RSI	= rationalization, standardization, and interoperability	TPI	= time period of interest
SCP	= System Concept Paper	TPS	= test program sets
SEM	= standard electronic module	TRADOC	= US Army Training and Doctrine Command
SI	= International System of Units	USATSG	= US Army TMDE Support Group
SOAP	= spectographic oil analysis procedure	UUT	= unit under test
SPL	= sound pressure levels	VE	= value engineering
ST	= system test	VHSIC	= very high-speed integrated circuit
T&E	= test and evaluation	VLSIC	= very large-scale integrated circuit
TADS	= target acquisition and designation system	WBGT	= wet-bulb global temperature

# CHAPTER 1

## INTRODUCTION

*The reasons for maintainability, i.e., reduced support costs and improved operational readiness—are presented. Maintainability and maintenance are defined, and quantitative measures of maintainability are introduced. The maintainability program encompassing its objectives, plan, and verification is discussed. Features that facilitate maintainability are listed. The importance of introducing these features as early as possible into the design process is stressed.*

### 1-1 INTRODUCTION

Maintainability and reliability are the two major system characteristics which combine to form the commonly used effectiveness index—availability. Although reliability and maintainability share co-importance, maintainability merits special consideration because of its influence on system maintenance activities, i.e., the expenditure of man-hours and material, which represent significant budgetary costs over the life of the system. Maintenance activities also reduce the operational readiness of a system.

With the introduction of modern, complex materiel resulting from sophisticated technology and the importance of keeping the materiel combat ready and its potential for higher failure rates and attendant increased maintenance actions, repairs could no longer be based solely on individual judgment and subjective analysis. It became evident that "how much time is required to replace or repair an item" was not the sole criterion, rather "how much time and skill are required to determine which item to replace or repair" and how to reduce the need for maintenance or the simplification of the action became equally important. The consideration of maintainability in designing a system is not a new concept—systems were always designed to have "good", "maximum", or "optimum" maintainability. Unfortunately, the use of these qualitative adjectives resulted in an "unknown" maintainability. New techniques, however, permit the conversion of these subjective qualitative judgments into an area of quantitative measurements. The threshold adopted by the US Army Materiel Command (AMC) is the operational requirement. Current AMC policy is to develop operational requirements in consideration of mission need, technical feasibility, and operating and support costs; and to document the requirement in the Decision Coordinating Paper (DCP) and System Concept Paper (SCP).

Maintainability is a risk area not because the requirements are not technically available: rather, it is a risk area because of the reluctance of the technical community to change from its traditional emphasis on performance as opposed to maintainability.

In summary, maintainability has emerged as an impor-

tant factor of the design process and an inherent design characteristic that is truly quantitative in nature and, therefore, lends itself to specification, demonstration, and trade-off analysis with such characteristics as reliability and logistic support. The implementation of this philosophy seeks the goals and objectives presented in par. 1-4.1. For the maintainability engineer this means that the optimum degree of maintainability must be incorporated in system design, beginning as early as the concept phase. If the maintainability engineer, working with the designer, fails to accomplish this, he fails to achieve his objective—i.e., the provision of operational availability. A system that fails to perform at times cannot safely be planned, which renders it useless for combat operations.

### 1-2 MAINTAINABILITY VS MAINTENANCE

Maintainability is a characteristic of design and installation. This characteristic is the measure of the ability of an item to be retained in or restored to a specified condition when maintenance is performed by personnel having specified skill levels and using prescribed procedures and resources at each prescribed level of repair (Ref. 1).

Maintenance is essentially the response to the maintainability program, i.e., the series of actions necessary for retaining materiel in or restoring it to a serviceable condition. Maintenance actions are of two types, i.e.,

1. *Corrective Maintenance.* An action required when equipment fails or malfunctions

2. *Preventive Maintenance.* An action required to maintain equipment in an operable condition through periodic servicing and/or replacement of components at specified intervals. Preventive maintenance can, and should, be conveniently scheduled to avoid interference with operating schedules. A detailed discussion of preventive maintenance is presented in Chapter 8.

Erroneously, corrective maintenance is referred to as unscheduled maintenance, and preventive maintenance is referred to as scheduled maintenance. From a practical standpoint military personnel perform maintenance—both corrective and preventive—whenever a window of opportunity exists. The specific maintenance tasks are a function of the reliability, availability maintainability,

## DOD-HDBK-791(AM)

and durability (RAM-D) of the equipment and the operational environment. The calendar time, i.e., when the maintenance action was performed, makes that action scheduled or unscheduled.

The unscheduled interruption of a planned operation is always undesirable and usually costly; in the extreme case it could be catastrophic. Although unreliability is usually the primary cause of failure and thus governs the frequency with which maintenance actions are necessary, the ease of maintenance and the skill of maintenance personnel govern the duration of the action. The easier it is to maintain an item of equipment, the fewer will be the demands on both the skill and number of personnel and, in general, the greater the reduction of equipment downtime. Accordingly, since the time required for maintenance actions is a function of the maintainability characteristics of the equipment, effectiveness of built-in testing and physical design features that affect the speed and ease with which maintenance can be performed should be addressed. Design features are discussed in par. 2-5.

In addition to physical design features, personnel and human factor considerations are of prime importance. These considerations include the experience of the technician, training required, skill level, supervision required, supervision available, techniques used, physical coordination and strength and number of technicians, and teamwork requirements. Personnel and human factors are emphasized because the Army—as well as the other Services—is imposing a strength cap on the number of military personnel and restricting the availability of funds for development and training, and procurement of training aids. Additionally, the scenario under which the new Army counters threats requires the deployment of light infantry. Thus the impact on engineering design must be that of ease of maintenance, adequate man machine interface, minimal maintenance, and maximum survivability. In no single area of weapon engineering are the potential rewards as great as those which could be achieved by simplifying the human functions needed to maintain the weapon system.

This brief introduction highlights the distinction between maintainability and maintenance. In summary, maintainability is a design characteristic that makes possible the accomplishment of operational objectives with minimal expenditure of support effort and resources and is a prime responsibility of the maintainability engineer working in cooperation with the designer: maintenance is the actions necessary for retaining materiel in or restoring it to a serviceable condition.

### 1-3 MEASURES OF MAINTAINABILITY

#### 1-3.1 GENERAL

In par. 1-1 it was pointed out that the maintainability characteristic had to be expressed quantitatively to be meaningful. This characteristic is expressed as the proba-

bility that an item will be retained in, or restored to, a specified condition within a given time period if prescribed procedures and resources are followed. There are several measurable parameters that can be used to quantify the maintainability characteristic, ease of maintenance. Ease of maintenance characterizes the maintainability designed into an equipment and can be measured by the elapsed time in which the maintenance can be performed. Thus the maintenance time required to correct equipment performance deviations, such as failure or degradation, is a good measure of how well the equipment has been designed for maintainability.

When maintenance time as a design parameter is measured, active time only should be considered. The emphasis is on the word "active" since there are administrative and logistic delays—e.g., absence of proper instructions and waiting for a repair part—that bear no relationship to equipment design.

Active-type maintenance time for corrective maintenance actions usually consists of three sequential steps, i.e.,

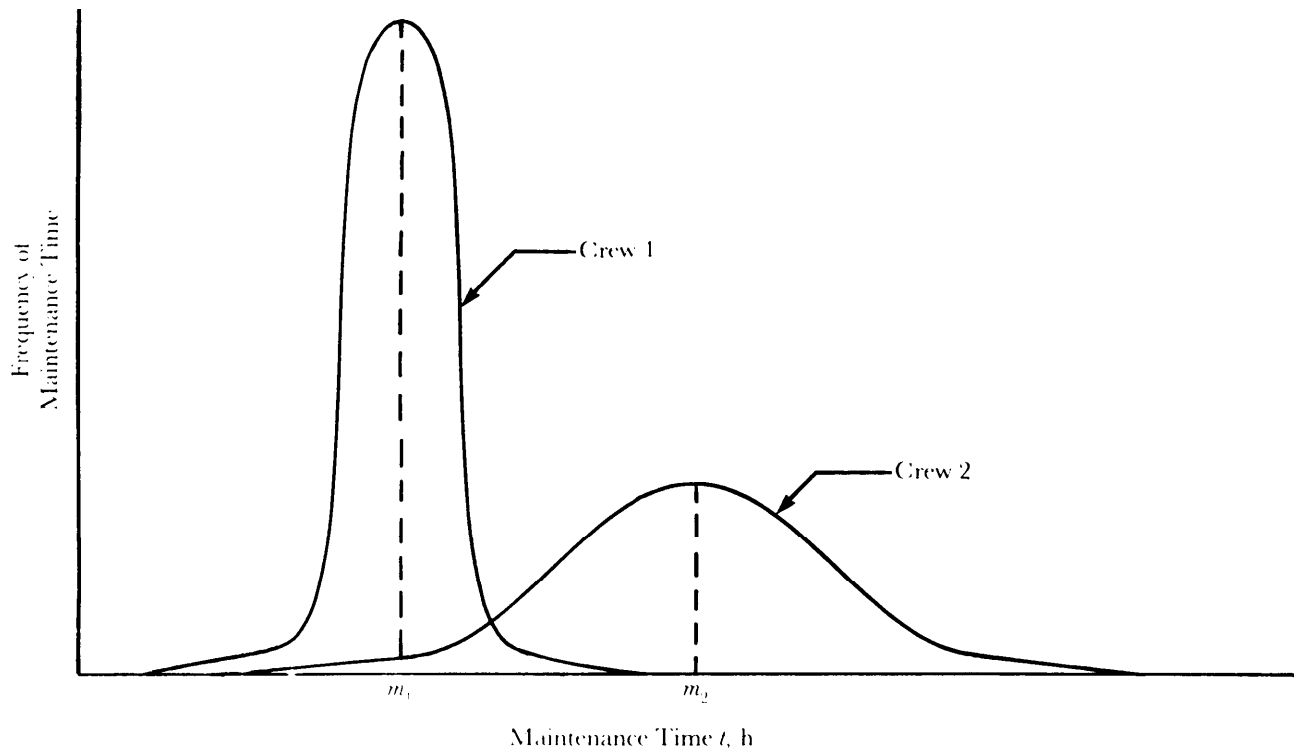
1. Time to locate the parts requiring repair
2. Time to perform the repair
3. Time to verify that the repair has been performed

successful).

For preventive-type maintenance, the first step is eliminated because the equipment maintenance area is predetermined.

Attributes of the equipment that cause variations in repair time result from the physical characteristics of the failed parts, their location and mounting arrangements in the equipment, and thus their accessibility and replaceability. Variations in the diagnostic time result from troubleshooting procedures, location of test points and kind of test equipment, and the sequence in which troubleshooting is performed. Also technicians' skills, their degree of familiarity with the equipment, and the environment in which maintenance is being performed affect both diagnostic time and repair time. Even identical maintenance actions, caused by identical failures in identical equipment and performed by the same repairman or repair crew, will have varying maintenance times. A large number of measurements probably would yield a continuous distribution of maintenance time for this maintenance action even if it were performed by the same technician or the same repair crew. The distribution of maintenance times for the same maintenance action with a different repair crew would also be different. Fig. 1-1 illustrates this phenomenon for two different crews.

Crew 1 performs the maintenance action with a mean time  $m_1$ ; Crew 2 takes a considerably longer mean time  $m_2$ . Also the variance of maintenance time with which Crew 2 works is substantially greater than that of Crew 1. Assume that both crews performed the identical maintenance operation under identical environmental condi-



**Figure 1-1. Distribution of Maintenance Time**

tions, at the same time of day, and are refreshed. It is reasonable to conclude from Fig. 1-1 that Crew 1 is more skilled and perhaps more disciplined than Crew 2.

Obviously, the time required for a given maintenance action is not a fixed value. This variability would be even more evident in sophisticated materiel where many different types of failures may occur, and where the necessary maintenance actions have their own time distributions and usually occur at a different rate.

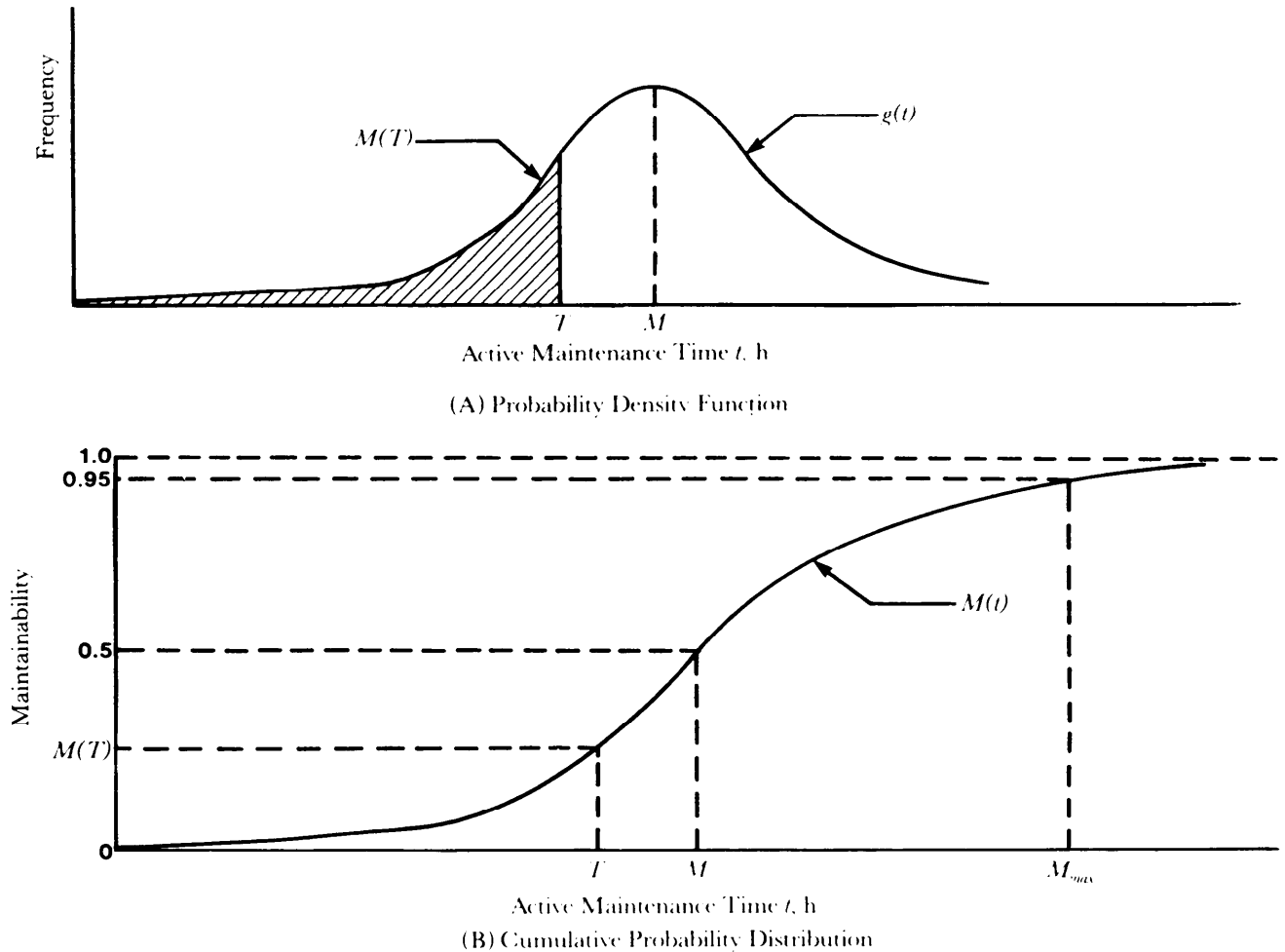
The previous discussion introduced terms distribution, mean, and variance used by the statistician. This suggests that maintenance time can be defined and analyzed by rigorous statistical techniques. To employ these techniques, specific elements describing maintenance time are necessary - a probability density function  $g(t)$  that shows the frequencies with which maintenance times of different duration occur and a cumulative probability distribution  $M(t)$  that shows the probability that maintenance time is equal to or shorter than a fixed time constraint. Fig. 1-2 represents the case for which the repair time appears to be normally distributed. The probability density function presented in Fig. 1-2(A) shows the frequency of maintenance occurrence versus a maintenance time; the cumulative probability distribution, Fig. 1-2(B), shows the probability of accomplishing maintenance versus maintenance time.

Some points of interest on the time axis of Fig. 1-2 should be noted.  $M$  represents the arithmetic mean of the

maintenance time distribution and, in this special case, it also represents the median of the distribution since a Gaussian distribution is indicated.  $M_{max}$  is the 95th percentile and represents the time in which at least 95% of all maintenance actions can be completed.

$M(t)$  is obtained by the integration of  $g(f)$ . This is seen in Fig. 1-2 where the probability  $M(t)$  on the maintainability axis of Fig. 1-2(B) corresponds to the area  $M(T)$  under the probability density curve of Fig. 1-2(A).  $M(T)$  is the probability that maintenance can be performed in a time  $T$  or less. Ref. 2 provides a detailed discussion of these relationships and the statistical concepts. Since  $M(t)$  is a probability, it can assume only positive values, i.e.,  $0 \leq \text{probability} \leq 1$ . A probability of zero means impossibility; a probability of one means certainty.

Because of its simplicity, the Gaussian case was used to illustrate the meaning of the statistical terms distribution, mean, and variance. In practice, however, a lognormal distribution frequently is assumed to describe the distribution of maintenance times. If tractability is desired, an exponential distribution may be assumed. Techniques such as the Kolmogorov-Smirnov test, which tests the hypothesis that the maintenance time was drawn from a population having a probability density function  $g(t)$ , should be used to determine the best-fit distribution before proceeding to compute mean times to repair. Ref. 3 describes the lognormal distribution and the Kolmogorov-Smirnov test.



**Figure 1-2. Maintenance Time Distribution and Maintainability Function**

### 1-3.2 QUANTITATIVE MAINTAINABILITY INDICES

There are many mathematical indices used to quantify maintainability. It is important to remember, however, that these relationships merely categorize data derived from planned testing. For maintainability, the test planning phase is equal in importance to the assessment phase. Testing that does not adequately demonstrate the effect of the physical features and personnel and support aspects (described in par. 1-2) actually provides data that effectively conceal the impact of these critical elements.

Indices used to support maintainability analysis must

1. Be composed of measurable quantities
2. Provide effectiveness-oriented data
3. Be readily obtainable from operational and applicable development testing.

These kinds of indices provide system designers, users, and evaluators with data operational readiness, mission success, maintenance manpower costs, and logistic sup-

port costs -that can be used to evaluate candidate systems more precisely.

Since maintainability programs must be tailored to the specific system, the terms used to define the various measures should be similarly selected; however, the terms should be standardized for similar major systems. It is also important that the numerical values associated with the terms describing system maintainability) must be operational values and not inherent values (Ref. 4). Because of their importance, the terms are defined:

1. *Operational Value.* A measure of maintainability which includes the combined effects of item design, quality, installation, environment, operation, maintenance, and repair

2. *Inherent Value.* A measure of maintainability which includes only the effects of item design and its application, and assumes an ideal operation and support environment.

Some common, accepted indices of maintainability are

1. Mean Time to Repair
2. Maximum Time to Repair

3. Mean Maintenance Time
4. Equipment Repair Time
5. Geometric Mean Time to Repair
6. Maintenance Man-Hours
7. Repair Rates
8. Maintenance Rates
9. Probability of Fault Detection
10. Proportion of Faults Isolatable
11. Automatic Fault Isolation Capability
12. Percent of False Alarms
13. Percent of False Removals.

These terms are defined in the Glossary. Equations for calculating these indices, together with examples, are found in Refs. 3, 5, and 6.

## 1-4 MAINTAINABILITY PROGRAM

### 1-4.1 OBJECTIVES

DoD Directive 5000.1 states, "Improved readiness and sustainability are primary objectives of the acquisition process. Resources to achieve readiness will receive the same emphasis as those required to achieve schedule or performance objectives. As a management precept, operational suitability of deployed weapon systems is an objective of equal importance with operational effectiveness." Operational suitability as defined by Ref. 7 is "The degree to which a system can be satisfactorily placed in field use, with consideration being given to...maintainability, safety, human factors, manpower supportability, logistic supportability, and training requirements." Today, when large masses of troops and materiel can be deployed anywhere in the world in a matter of days or even hours, system readiness demands the utmost attention.

The importance of a maintainability program to the system acquisition process is well established by the previous discussion. Therefore, to accomplish its stated pur-

pose, the maintainability program must contribute to achieving the following objectives (Refs. 8 and 9):

1. Improved operational readiness
2. Reduced maintenance manpower needs and assurance that the fielded system can be operated and maintained with skills and training expected to be available to the Army
3. Reduced life cycle costs, i.e., economically operated and maintained
4. Assurance that maintainability requirements are properly demonstrated and assessed during development and operational test and evaluation. Fig. 1-3 illustrates the time phasing for maintainability verification, demonstration, and evaluation.
5. Provision of data essential for management, i.e., assurance that the results of maintainability assessment are presented in a form suitable to support the decision-making process.

It must be recognized that these objectives are interrelated and affect both operational effectiveness and ownership costs. Accordingly, they must be applied skillfully to avoid being duplicative or contradictory, and at each level at which maintenance is to be performed. These same goals also may apply to related programs, e.g., reliability, and may require the same kind of tasks and analysis to demonstrate and verify them. To avoid duplication of effort, performance of such tasks or analysis will be coordinated and whenever possible combined with similar tasks called for under other program elements (Ref. 9). Coordination may require trade-offs. However, in the trade-off process care must be exercised to insure that maintainability demonstration and evaluation are not sacrificed.

Cost is an item of consideration at each phase in the acquisition process—concept exploration, demonstration and validation, full-scale development, and production and deployment. Since maintainability is dedicated to

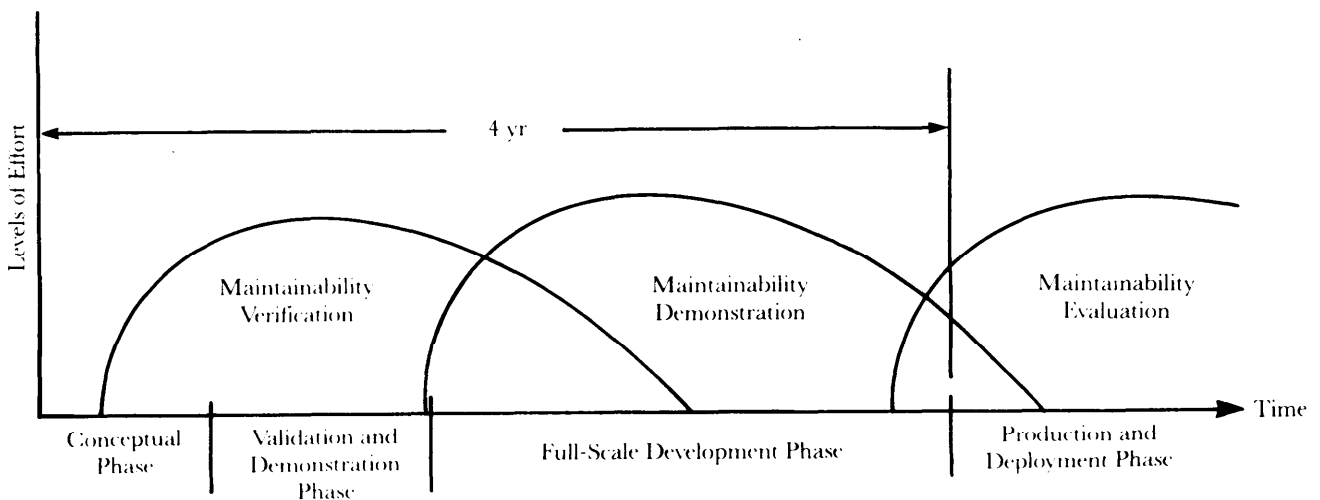


Figure 1-3. Maintainability Level of Effort

## DOD-HDBK-791(AM)

cost reduction over the life of a system, maintainability engineering input is an essential element in the evolution of a system.

### 1-4.2 MAINTAINABILITY PLAN

The maintainability program will include the tasks necessary to achieve and demonstrate the goals indicated in par. 1-4. The various tasks and their relationships to the acquisition process are presented in MIL-STD-470 (Ref. 9). A matrix illustrating these relationships is shown in Table 1-1. The degree of maintainability achieved will depend on the imposed requirements and management's emphasis on maintainability. The tasks are not to be applied indiscriminately: All maintainability requirements do not apply to all systems. Instead, they are to be tailored as required by their users as appropriate to particular

systems or equipment program type, magnitude, and need (Ref. 9). Tailoring (Ref. 9) is the process by which individual requirements of the selected specifications, standards, and related documents are evaluated to determine the extent to which they are most suitable for a specific system and equipment acquisition, and the modification of these requirements to insure that each achieves an optimal balance between operational needs and costs. The tailoring process, however, must conform to provisions of existing regulations governing maintainability programs and take care not to exclude those requirements that are determined essential to meeting minimum operational needs.

The elements that comprise the maintainability plan are explicitly detailed in MIL-STD-470 (Ref. 9) and should be used as a guide in plan preparation. MIL-STD-

**TABLE 1-1. APPLICATION MATRIX (Ref. 9)**

Task Title	Task Type	Concept	Valid	Program Phase		
				FSD	Prod	Operat System Devs (MODS)
Maintainability Program Plan	MGT	N/A	G(3)	G	G(3)(1)	G(1)
Monitor/Control of Subcontractors and Vendors	MGT	N/A	S	G	G	S
Program Reviews	MGT	S	G(3)	G	G	S
Data Collection, Analysis and Corrective Action System	ENG	N/A	S	G	G	S
Maintainability Modeling	ENG	S	S(4)	G	C	N/A
Maintainability Allocations	ACC	S	S(4)	G	C	S(4)
Maintainability Predictions	ACC	N/A	S(2)	G(2)	C	S(2)
Failure Modes and Effects Analysis (FMEA) Maintainability Information	ENG	N/A	S(2)(3)(4)	G(1)(2)	C(1)(2)	S(2)
Maintainability Analysis	ENG	S(3)	G(3)	G(1)	C(1)	S
Maintainability Design Criteria	ENG	N/A	S(3)	G	C	S
Preparation of Inputs to Detailed Maintenance Plan and Logistics Support Analysis (LSA)	ACC	N/A	S(2)(3)	G(2)	C(2)	S
Maintainability Demonstration (MD)	ACC	N/A	S(2)	G(2)	C(2)	S(2)

Code Definitions for Table:

- S = Selectively applicable
- G = Generally applicable
- C = Generally applicable to design changes only
- N/A = Not applicable
- ACC = Maintainability Accounting
- ENG = Maintainability Engineering
- MGT = Management
- FSD = Full-scale development
- PROD = Production

- (1) Requires considerable interpretation of intent to be cost-effective.
- (2) MIL-STD-470 is not the primary implementation document. Other MIL-STDs or Statement of Work requirements must be included to define or rescind the requirements. For example, MIL-STD-471 must be imposed to describe maintainability) demonstration details and methods.
- (3) Appropriate for those task elements suitable to definition during phase
- (4) Depends on physical complexity of the system unit being procured, its packaging, and its overall maintenance policy.

470 (Ref. 9) is very specific about the importance of allocating and predicting maintainability. The basis for the process must be linked closely to the equipment support concept, available maintenance manpower, and optimum design for repair as a function of survivability, redundancy, and battle damage. To obtain a maintainability-friendly design, a partnership between industry and Government is necessary—there must be an enhanced management awareness of the maintainability requirement by both industry and Government managers during the acquisition process. Contractors will respond to DoD priorities.

### 1-4.3 VERIFICATION, DEMONSTRATION, AND EVALUATION OF MAINTAINABILITY REQUIREMENTS

The preparation of a plan that includes the elements that insure the system will have the characteristic of maintainability designed into it is an important first step. However, to assess system maintainability quantitatively, the provisions of the maintainability plan must be verified, demonstrated, and evaluated. Unless this is done, the qualitative descriptors good, maximum, optimum—described in par. 1-1 apply.

MIL-STD-471 (Ref. 5) provides procedures and test methods for the verification, demonstration, and evaluation of qualitative and quantitative maintainability requirements. "These actions are performed in accordance with the maintainability test plan described in par. 1-4.2. The time phasing of these actions relative to the acquisition process is illustrated in Fig. 1-3. MIL-STD-471 also provides for qualitative assessment of various integrated logistic support factors related to and impacting the achievement of maintainability parameters and item downtime e.g., technical manuals, personnel, tools and test equipment, maintenance concepts, and provisioning.

AR 702-3 (Ref. 8) provides additional information on testing the various maintainability parameters; responsibilities for conducting the test; conduct of the tests; scoring of the tests; and evaluation of the maintainability features; and evaluation of the maintainability features to identify needed changes in equipment design or equipment maintenance—e.g., maintenance allocation chart—and revisions, as appropriate, to the maintenance plan/support concept.

To be effective, the results of the evaluation analyses must provide information to designers and managers so that the analyses are actually causing change—if required—in the design rather than recording data on the design that exists. The timing and credibility of these analyses must be such that they are accepted as part of the design evaluation. A common flaw in many maintainability programs is to have the analyses separated from design activity by time, distance, or organization. The role of the maintainability analyses can often be an indicator of the importance placed upon these tasks by the design team.

## 1-5 FEATURES TO FACILITATE MAINTAINABILITY

Maintainability requirements, and the resulting maintenance actions, must be supported by system design. Qualitative and quantitative requirements must be established to provide system design guidelines during system development; it is mandatory that a system maintainability concept be formulated prior to detailed design. Identification of maintenance requirements is a key contributor to cost-effectiveness. When life cycle cost is minimized, a major factor is ease of maintenance.

Features that facilitate maintainability include the elements of physical attributes, diagnostics, simplification, testability, inspectability, accessibility, and maintainability time/cost design criteria commensurate with the maintainability profile of the system. Each of these elements is considered by the maintainability engineer in his development of concepts, criteria, and technical requirements to assure timely, adequate, and cost-effective support of the design and operational needs of the system. Physical features and pertinent questions that affect maintainability follow:

1. *Accessibility*. Can the item be reached easily for repair or adjustment?
2. *Visibility*. Can the item being worked on be seen?
3. *Testability*. Can system faults be detected readily and isolated to the faulty replaceable assembly level?
4. *Complexity*. How many subsystems are in the system? How many parts are used? Are the parts standard or special purpose?
5. *Interchangeability*. Can the failed or malfunctioning unit be readily replaced with an identical unit with no requirement for alteration and calibration?
6. *Identification and Labeling*. Are components uniquely identified? Are the labels permanent, or are they easily erased or obliterated by operation or maintenance actions? Are labels positioned to be easily read?
7. *Verification*. Can it be easily verified that the repaired item is functioning correctly?
8. *Simplicity*. Is the design as simple as possible? Are standard parts and tools used? Are functions and parts consolidated?

Pertinent questions to be asked concerning the rationale to be considered in assessing the previous design features are

1. Are features compatible with maintainability resource developments?
2. Is the system friendly to maintenance in providing accessibility, fault isolation capability, and packaging for reliability?
3. Can calibration and precision measurements be easily and readily accommodated or the need totally eliminated?
4. Is the system packaged for fault isolation and

## DOD-HDBK-791(AM)

repairability as required by the maintainability concept, manpower, and skill restraints?

5. Are design trade-offs considered with maintainability requirements? Exercise care so that the require-

ments are not sacrificed for expediency or budgetary considerations.

The means for implementing these design features are discussed in the chapters that follow.

## REFERENCES

1. MIL-STD-721 C, *Definitions of Effectiveness Terms for Reliability, Maintainability, Human Factors, and Safety*, 12 June 1981.
2. MIL-HDBK-472, *Maintainability Prediction*, 12 January 1984.
3. AMCP 706-133, *Engineering Design Handbook, Maintainability Engineering Theory and Practice*, January 1976.
4. DOD Directive No. 5000.40, *Reliability and Maintainability*, 24 February 1982.
5. MIL-STD-471 A, *Maintainability Demonstration*, 8 December 1978.
6. T. F. Pleska, F. L. Jew, and J. E. Angus, *Maintainability Prediction and Analysis Report*, Hughes Aircraft Company Report, RADC-TR-78-169, Rome Air Development Center, Air Force Systems Command, Griffiss Air Force Base, NY, July 1978.
7. DOD Directive No. 5000.1, *Major System Acquisitions*, 29 March 1981.
8. AR 702-3, *Army Materiel Systems Reliability, Availability, and Maintainability (RAM)*, 1 May 1982.
9. MIL-STD-470A, *Maintainability Program Requirements (For Systems and Equipments)*, 3 January 1983.

## BIBLIOGRAPHY

MIL-STD-2165, *Testability Program for Electronic Systems and Equipments*, 26 January 1985.

MIL-STD-2077, *Test Program Sets, General Requirements for*, 9 March 1978.

## CHAPTER 2

# SIMPLIFICATION

*Simplification is defined and the importance of it as a factor in maintainability is emphasized. Five techniques for achieving simplification are discussed: (1) Coordination of Equipment and Job Design, (2) Part Reduction, (3) Function Consolidation, (4) Access Improvement, and (5) Maintenance Procedure Streamlining. Part reduction and function consolidation are described as functions of system-level trade-offs and value engineering. Features to enhance an approved support plan are presented. Examples of complex modules redesigned to achieve simplicity are included, and a simplification design checklist is provided.*

### 2-1 INTRODUCTION

General Maxwell D. Taylor, while chairman of the Joint Chiefs of Staff, commented on the modern Army as follows: “our Army must be able to disperse and hide, and converge and fight. It must be able to shoot, move, and communicate. If we are to attain this concept of mobility, we must reduce our requirements for logistical support.”. Despite the fact that this statement was made 20 yr ago, it is still relevant today the “shoot and scoot” tactic still applies.

For many years roughly 11 cents of every dollar in the defense budget was expended for maintenance; the support costs of some systems exceeded their acquisition costs many fold, and the number of maintenance technicians required for support exceeded the number of operating personnel. The continued development and deployment of highly complex systems such as guided missiles, communication networks, computers, and reconnaissance devices—require a mass of on-site support equipment which in turn demands massive logistic support.

The common denominator of all support costs appears to be complexity --not solely system complexity but also complexity of operation and maintenance. If this is true, then design for both simplicity of operation and maintenance is the area that offers the most promise for reduction of support costs. A certain amount of equipment complexity is necessary, and the designer should try to achieve ease of maintainability in spite of complexity. The major support costs could be greatly reduced if the designer working in conjunction with the maintainability engineer were constantly aware of the limitations of operator and maintenance personnel and of the adverse environment in which such personnel must perform - personal fatigue, blackout conditions, cold, rain, mud, dust, etc. A maintainability feature that reduces the number of maintenance personnel, however, does not tell the complete story. This feature may also result in the elimination of an item of test equipment which in turn eliminates the requirement for manuals to operate and repair the test item and for backup facilities to repair the item—i.e., a snowball effect. This same scenario could be applied to the elimination of a part.

Simplification is easy to mandate but is probably the

most difficult maintainability characteristic to achieve. The rewards are great because the results are a significant driving factor in the reduction of life cycle costs. Simplicity is worth the effort invested to achieve it and should be the constant goal of every design engineer.

### 2-2 DESIGN TECHNIQUES

There is a general tendency on the part of designers of equipment to produce an overly complex product. In many cases the equipment uses too many parts, has too close operating tolerances, is too expensive to build, and is difficult and expensive to maintain. The resolution of these factors, to develop a simple design, is the result of compromises and trade-offs among the user, designer, and maintainability engineer but never at the expense of system availability or effectiveness. For example, if for a given system the desired degree of availability cannot economically be achieved by the incorporation of reliability in its design, then it can be achieved only by increased emphasis on maintainability characteristics that will reduce downtime. Maintainability, however, should not be used as a crutch for reliability. Trade-offs in maintainability should encompass reliability, support, cost, and state-of-the-art design for testability using built-in test equipment and automatic test equipment.

Design techniques for achieving simplification include

1. Coordination of equipment and job design
2. Reduction in number of parts
3. Value engineering
4. Consolidation of functions
5. Improved access to parts
6. Streamlined maintenance procedures
7. Software maintenance.

In applying these techniques, the necessity for trade-offs and compromises previously discussed must be considered. Equally important is the impact of these techniques on the logistical support plan. The resultant equipment design should represent the simplest configuration possible consistent with functional requirements and expected service and performance conditions.

Each of these techniques is discussed in the paragraphs that follow.

## **2-2.1 COORDINATION OF EQUIPMENT AND JOB DESIGN**

The design of new equipment is also the design of new jobs for both the operator and the maintenance technician. The more human factors engineering is considered in the design of new equipment, the better these two jobs of operating and maintaining can be done. In the design of equipment, effort should be directed toward simplifying the operator's and maintenance technician's tasks; this can be accomplished by the recognition of the importance of integrating job design and equipment design during the early stage of equipment design. The comparative simplicity or difficulty of the maintenance task is built into the equipment. Thus the engineer is unconsciously designing a job when he designs a piece of equipment; accordingly, he should be aware of the capabilities and limitations of the human being on whom effective maintenance depends. Therefore, specialists in human factors engineering and in personnel training should assist in planning the equipment. Even an equipment that performs complex operations can be designed so that it is comparatively easy to operate and maintain – a telephone is an example—by providing standard and interchangeable parts, by using a simple method of testing and diagnostics, and by providing ready access to defective parts. These factors are touched upon in the paragraphs that follow and covered in detail in subsequent chapters. The design engineer must remember that regardless of the excellence of his design, it will be no better than the maintenance of it, and the maintenance will be performed by personnel of average ability.

## **2-2.2 REDUCTION OF PARTS**

Reduction in the number of parts in an end-item should lead to a lower number of maintenance actions and thus to improved end-item availability. However, part reduction is subject to interface agreements between maintainability and other design disciplines; these other disciplines often benefit from increased numbers of parts. Reliability, safety, and survivability specialists often promote redundancy of parts to avoid mission aborts, accidents, and combat loss. The maintainability specialist might also want to add parts to increase testability and self-healing aspects of the end-item. Thus, the important consideration in part reduction is that it must involve combined efforts and trade-offs which optimize system cost-effectiveness.

Part reduction often can be achieved by examining interfaces between different work assignments. For example, the fuel system designers for the end-item and the engine suppliers may both have supplied check valves to perform an identical function. In special weapon adaptation kits, test interfaces should be examined. If electrical fuses are required to protect the safing and arming circuits from excessive currents or voltage accidentally imposed

by external monitoring and or test equipment, these fuses should be located in the external test equipment, not in both the adaptation kit and the test set. The test set is the logical location because of easy access for replacement. Also the inclusion of unnecessary parts in circuits reduces the reliability of the circuits out of proportion to their convenience and may be the source of sneak circuits.

Modularization discussed in detail in Chapter 5 contributes to simplicity by reducing the number of exposed parts that may require replacement. If the module is discarded or destined for repair at the depot level, there is a serendipitous effect it reduces the need for addressing the contained parts in manuals and repair parts lists. It reduces the required skill level of technicians, and reduces the inventory of repair parts. Despite the benefit, modularization has the potential for increasing the cost of repair parts and complexity of repair at the depot level.

## **2-2.3 VALUE ENGINEERING**

Value engineering may also be employed to bring about simplification. Value engineering is a questioning type of technique; the type of approach can be characterized by these questions:

1. What is it?
2. What does it do?
3. What does it cost?
4. What else will do the job?
5. What does that cost?

Cost must obviously be interpreted to include the logistical cost. In pursuing this approach it is important that the essential product performance, reliability, and maintainability are locked into the value engineered item. Like any good problem-solving technique, value engineering is a challenging and searching methodology. It is forever forcing the value engineering practitioner to dig for fundamentals—i.e., to determine what the part or function is really intended to achieve and whether the part is necessary.

Part reduction need not be limited to end-item design. Life cycle cost can be reduced by critically examining the need for every piece of support equipment—stands, tools, testers, and transport devices. This is especially applicable to the apparent need for new support equipment when existing standard equipment can be made compatible with new end-items. Also the end-item may be altered, without loss of function, to be compatible with existing support equipment.

## **2-2.4 CONSOLIDATION OF FUNCTIONS**

Consolidation of functions is probably the most important design technique for simplification. In the abstract this can be illustrated by the simple example of multiplying a series of numbers by a common factor and summing the result—i.e., multiply the elements *b*, *c*, *d*, and *e* by a

common factor  $a$  and sum the result. This operation can be performed by

$$\begin{array}{r} a \cdot b \\ a \cdot c \\ a \cdot d \\ + a \cdot e \\ \hline a \cdot b + a \cdot c + a \cdot d + a \cdot e \end{array} \quad \text{or } a(b + c + d + e).$$

The end results are identical; however, the first operation required four multiplications and one addition, and the second operation required only one multiplication and one addition. An analysis of the task to be performed indicates the procedure to be adopted to simplify the operation. An analysis of the various functions to be performed by components of weapon systems and the types of available hardware to do the required task often can lead to overall simplification. An operational or hardware approach can be employed to achieve simplification.

In the operational approach, hardware performing similar functions could be conveniently grouped to facilitate operator performance. For example, if a system required a number of readouts to determine its operability, the readouts should be grouped onto a single panel to facilitate observation. Also any adjustment required to bring a meter reading into line should be easily observable by the operator making the adjustment.

In the hardware approach, multiple functions can be incorporated into a single item of hardware or controlled by or from a centralized location or operation. For example, turning on the power switch of a personalized computer not only provides power but also activates the "power-on self-test" (POST) that initiates software programs which check for the presence of peripherals, clear status flags so that the computer can be set up according to a specified use condition, check the presence and condition of hard disks and other subsystems, and determine the amount of access memory available and test to insure no failures.

A good example of the consolidation of related mechanical or electrical functions into a single activator or control—lever, switch, component—to produce simplification is the automobile, with which everyone is familiar, i.e.,

1. Control of windshield wiper and washer by a single lever
2. Consolidation of ignition and starter switch into a single assembly
3. Use of braking systems that feature a self-adjustment capability
4. Use of engine assemblies that feature a valve lash compensator
5. Use of a notched serpentine belt, with power takeoff from crankshaft, to wrap around pulleys for every power accessory i.e., one pulley to perform many functions.

Logic must prevail in the practice of consolidation of functions because, carried to the extreme, it could result in a more complex system.

## 2-2.5 IMPROVED ACCESS TO PARTS

Accessibility is defined as a design feature that affects the ease of admission to an area for the performance of visual and manipulative actions. Thus, as a prime factor in relation to maintainability, accessibility relates to the configuration of hardware rather than to the physical and other limitations of personnel. Considerations of accessibility are, and in their turn exert influence on, virtually all other maintainability factors. For simplicity in maintenance, accessibility must satisfy two needs, i.e.,

1. Access to an item for inspection and testing, providing ample room to attach test equipment
2. Space in which to adjust, repair, or replace the failed item.

Configuration, or packaging, enhances accessibility by placing items that are expected to require maintenance most frequently where they will be most accessible. If the failure rate for a particular item is high, accessibility is mandatory.

A detailed discussion of accessibility and methods of achieving it are presented in Chapter 4.

## 2-2.6 STREAMLINED MAINTENANCE PROCEDURES

The ultimate goals of maintainability design are reduction to a minimum of the system support requirements after the system has been released to the user and the facilitation of whatever maintenance work the system will require. The integrated logistical support plan, initiated when the performance requirements of the system were being formulated, dictates how the system is to be maintained, e.g.,

1. Malfunction isolation shall be positive to the throwaway level and shall not require human decision or reference to manuals.
2. All throwaway items shall be replaceable within "x" minutes.
3. No maintenance adjustments shall be required.

The task of maintenance simplification does not end with the establishment of the support plan. Derivative actions, which may be regarded as a subset of the basic plan, can be taken by both the designer and user to insure the success of the support plan, e.g.,

1. Part configuration
2. Maintenance scheduling
3. Simplified diagnostic techniques.

### 2-2.6.1 Part Configuration

Maintainability simplification can be compared to a successful "do-it-yourself" kit. A good design is so simple

## DOD-HDBK-791(AM)

fied that a diagram of the item immediately suggests the method of assembly or disassembly; however, until a technician is thoroughly familiar with the operation, he should be encouraged to study the documented procedure the “read instructions when everything else fails” is a dangerous philosophy. In a design of this nature, assembly is obvious by means of component parts that fit together in a unique manner because of their external configuration. Also since familiarity and use of a common part are important considerations in part design and selection, maximum effort should be made to promote the use of standard parts and components.

The assembly of parts can be simplified by part design or by support equipment designed to position parts so that they cannot be incorrectly aligned or mounted. A common method is to provide locating holes for the insertion of dowel pins to position parts in the correct orientation for mounting or for ease of insertion. Support equipment, by proper design, can permit ease of positioning for installation of attachments—e.g., a carrier for a weapon pod could be designed with a wing-to-carrier guidebar that could align the pod for quick attachment.

Removable fasteners, e.g., screws and bolts, should be of the same size wherever possible and of a standard size and only in the number required to secure an item properly. This simple design feature will reduce the parts inventory and lessen the requirement for special tools.

### 2-2.6.2 Scheduling of Maintenance

Scheduled and deferrable maintenance functions can often be performed during the same time period, which results in reduced equipment downtime. i.e., increased availability. For example, a modification work order (MWO) that does not affect system safety or functioning can be deferred until the equipment undergoes routine scheduled maintenance, or a clutch adjustment could be deferred until an oil change was required. Also the necessary special tools, repair parts, and manuals can be assembled in preparation for the deferred maintenance; this will reduce administrative downtime.

### 2-2.6.3 Simplified Diagnostic Techniques

Because the preponderance of repair time required for any item, subsystem, or system normally is attributable to fault isolation, it is imperative that provision be made for the most effective diagnostic (troubleshooting) routines. Manual techniques—basically trial-and-error efforts by skilled technicians using meters, oscilloscopes, and other test devices, as well as detailed schematics, to isolate a malfunctioning component by progressively eliminating those that are still functioning—should be eliminated at all levels of maintenance except depot. Semiautomatic and/or automatic techniques must be prescribed for unit level maintenance because unit maintenance is structured for quick turnaround based on repair by replacement and

minor repair—check, adjust, clean, lubricate, and tighten addition of fuel, and maintenance of liquid levels. Test equipment, if necessary at the unit level, should be of the “go” “no go” type, which requires no interpretation of signal data. The vacuum tube testers, located in drug stores before the introduction of solid-state electronics, are examples.

## 2-2.7 SOFTWARE MAINTENANCE

Ease of maintenance usually is associated with good documentation, a small number of statements per program, and the level of language used to write the programs. Programs should be prepared in high level (compiler) language, whereby a single statement translates several into many machine-language instructions. For example, consider three variables, A, B, and C related by the statement

$$\text{VARA} = \text{VARB} + \text{VARC}$$

which translates into

1. Load VARB
2. Add VARC
3. Store VARA.

In most languages each variable must be uniquely declared (defined) and typed integer, character, logic, number of bytes, and manner in which stored prior to use in any programming instruction (module). Examples of higher level languages are ADA, PASCAL, and C. ADA is the preferred language for Army software and, therefore, should be used.

Block structuring a technique allowing program segmentation into blocks of information or subroutines of a total program should be used because when properly applied in a top-down arrangement, they are essentially self-documenting. This technique permits the program to be read and understood by someone who did not write the program; thus it lends itself to being easily changed or maintained. In applying this technique, backward referencing (looping) should be avoided.

## 2-3 EXAMPLES OF COMPLEX MODULES REDESIGNED FOR SIMPLICITY

This paragraph describes five complex hardware and software modules that have been redesigned by applying a range of simplification principles.

### 2-3.1 UH-60A HELICOPTER

The UH-60A BLACK HAWK utility helicopter requires only 2.5 to 3 man-hours of maintenance per flight hour at the unit level (Ref. 1). This compare to 12 to 20 h for the family of helicopters it replaces. This increase in maintainability can be attributed largely to simplification of the main rotor head design. Unlike previous designs, which had upper and lower plates tied together with vertical and horizontal hinges, the BLACK HAWK main

rotor head is forged from a single piece of titanium. an elastomeric bearing, which is completely dry and requires no lubrication and is said to have an average life of 3000 h, eliminates the need for hinges. In earlier designs, the hydraulic reservoir seals have been known to fail and cause loss of lubrication and wear to the main rotor head, which necessitates overhaul. Typically, mean time between removal (MTBR) for older designs of such components was less than 500 h. Simplification has resulted in dynamic component MTBR requirements of at least 1500 h.

### 2-3.2 155-mm HOWITZER

For many years, the muzzles of the 155-mm guns and howitzers were protected by mechanical muzzle plugs; these plugs consisted of a metal dish that was locked in place by turning a hand wheel which took up on a threaded link and thus spread a three-legged expanding toggle inside the gun barrel. This assembly cost \$64 and required maintenance. A molded neoprene plug that requires no maintenance was substituted at a cost of \$6. This simplification also has improved safety: forgetting to remove the plug before firing no longer has disastrous results.

### 2-3.3 M230 GUN

It is imperative that any gun used in a combat vehicle be easily maintainable. the current trend is toward externally powered guns, which based upon their design, has lead to a reduction in replaceable parts. this fact translates into ease of maintenance. for example, the 30-mm

automatic, externally powered gun, M230, has only 149 parts, including barrel, drive motor, feed string, and recoil adapters. This compares favorably to 300 parts in the Model 188 Gattling gun. Fig. 2-1 contrasts a Gattling gun design with that of the M230. Fig. 2-2 illustrates the self-powered feed design that makes part reduction possible.

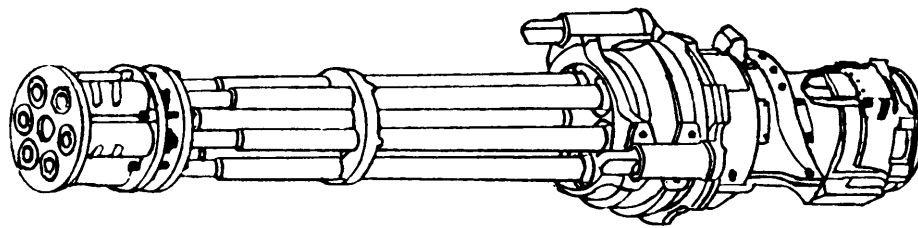
Further, the new 30-mm gun has been designed for quick disassembly without the need for supplementary tools or equipment. The tools required for disassembly are provided with the gun mechanism. Disassembly and reassembly are accomplished in three minutes or less. The gear boxes are sealed for the life of the unit (Ret. 2).

### 2-3.4 INFRARED SUPPRESSOR

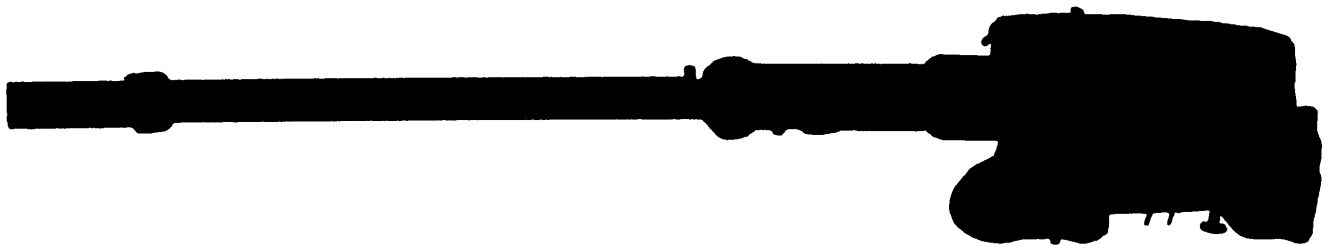
To reduce the threat from infrared homing missiles, the gas turbines used in tanks and helicopters must be cooled. This cooling was achieved with large fans which were difficult to remove and replace. A new approach using the "ocarina" IR suppressor named after a simple musical instrument breaks up the hot gas plume and is said to draw in more cool air than the engine is generating as hot exhaust. There are no moving parts in this simplified design (Ref. 3).

## 2-4 SIMPLIFICATION CHECKLIST

Table 2-1 should be used in evaluating the design of an item for simplification. If an answer is "no" for any question on the checklist, the design should be restudied to determine whether correction is required.



(A) Model 188 Gattling Gun



(B) 30-mm M230 Gun

**Figure 2-1. Comparison of the M188 20-mm Gattling Gun to the M230 30-mm Gun**

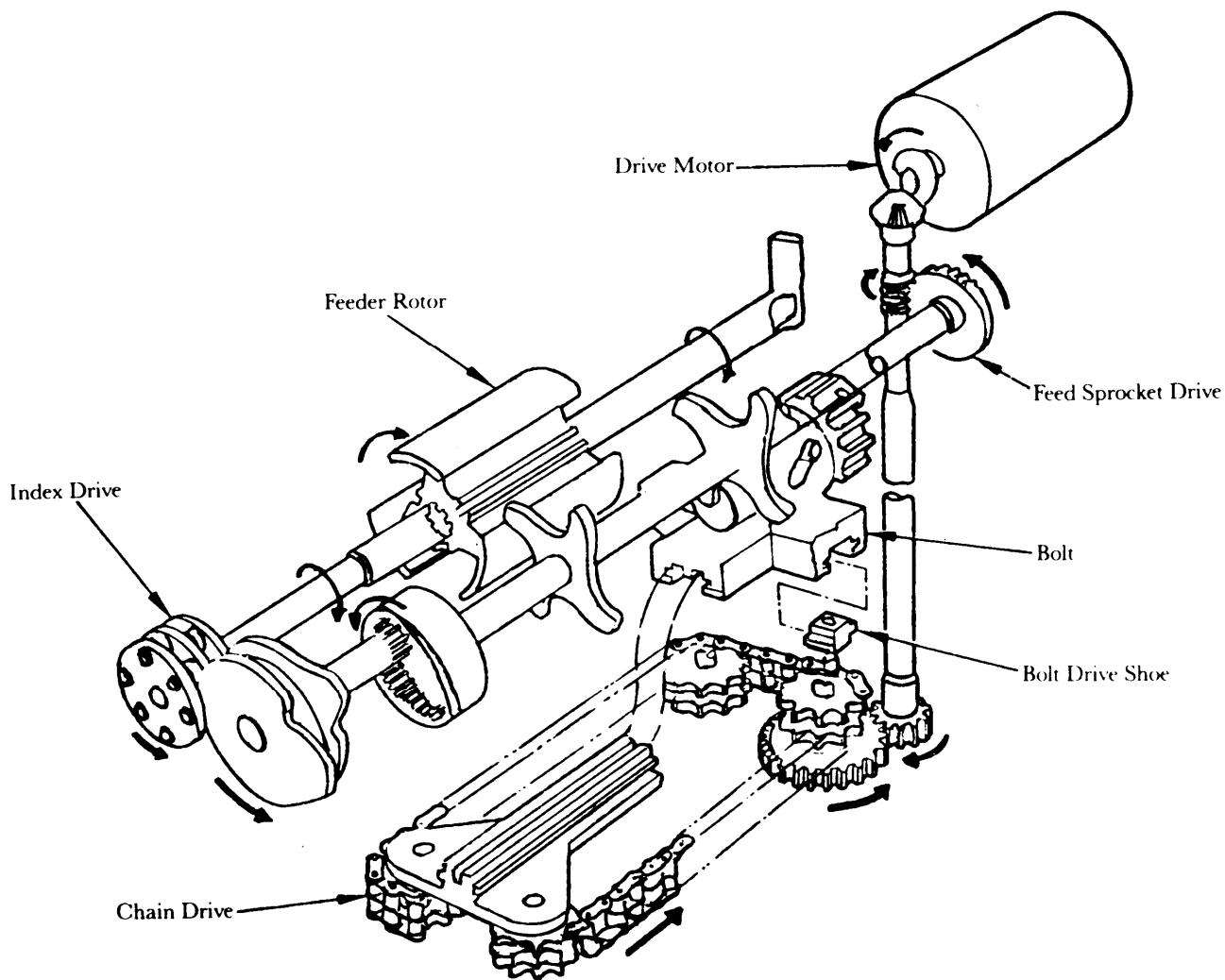


Figure 2-2. Simple Self-Powered Feed System in M230 Gun

**TABLE 2-1. SIMPLIFICATION CHECKLIST**

1. Has the system been searched for simplified alternatives?
2. Could this function be performed by a standard or existing part?
3. Is this function duplicated on both sides of a work assignment interface?\*
4. Could the use of a manifold or multiplexing (electrical) reduce the number of parts required?
5. Can the manual data be understood by an average person with a junior high school (seventh or eighth grade maximum) education?
6. Is the computer software well documented prior to use?
7. Has simplification brainstorming been attempted?
8. Can functions be consolidated in terms of time, place, people, or instruments?
9. Does the design minimize system components while considering requirements for redundancy?
10. Is this function or part really necessary?
11. Is this item simple to maintain but difficult to operate, i.e., has the quest for simplicity been counterproductive?
12. Are requirements for lubrication minimized? When lubrication is required, is there easy access?
13. Have oil sight gages been positioned to be directly visible to the service crew without the use of special stands or equipment? Is there easy access for adding liquids to maintain their required level? Are see-through containers used for visibility of levels?
14. Are all wrenching or adjustment locations visible in prevailing light?
15. Are all wrenching functions designed for the same size wrench? Same torque values?
16. Has the number of attachments been minimized?
17. Has each requirement for a tool or GSE been analyzed to determine whether the need can be eliminated or the tool made common with those already used?
18. Have quick disconnects been provided for hydraulic, fuel, oil, and pneumatic line couplings for all components subject to time replacement or minimum service life and for all modular components?
19. Does the design avoid the use of parts or materials that are known to have caused reliability and maintainability (R&M) problems in earlier designs?
20. Does the design provide components that require little or no preventive or scheduled maintenance actions?
21. Does the design allow for logical and sequential function and task allocations?
22. Have circuits been avoided which require a high degree of voltage regulation?
23. Can adjustable circuits be further reduced?\*
24. Are mechanical adjustments held to a minimum?
25. Are the attaching parts for doors and items all the same size in each application? Are any differences of size necessary?
26. Are diagnostic techniques simplified?
27. Has human factors engineering been considered in design of equipment?

\*A yes answer to these questions indicates a need to reexamine the design for correction.

## REFERENCES

- |  |  |
|--|--|
| <ol style="list-style-type: none"> <li>1. Ramon Lopez, "UH-60A BLACK HAWK in Production", <i>Interavia</i>, November 1978.</li> <li>2. J. Philip Geddes, "Introducing the CHAIN GUN,®",</li> </ol> | <ol style="list-style-type: none"> <li><i>International Defense Review</i>, February 1977.</li> <li>3. J. Philip Geddes, "Hughes Helicopters AH-64 in Advanced Development", <i>Interavia</i>, August 1978.</li> </ol> |
|--|--|

## BIBLIOGRAPHY

- |  |   |
|--|---|
| <p>MIL-STD-2165, <i>Testability program for Electronic systems and Equipment</i>, 26 January 1985.</p> | <p>MIL-STD-1472C, <i>Human Engineering Design Criteria for Military Systems, Equipment and Facilities</i>, 10 May 1984.</p> |
|--|---|

**This page intentionally left blank.**

## CHAPTER 3

### STANDARDIZATION AND INTERCHANGEABILITY

*Standardization and interchangeability are defined; their close relationship to each other and their influence on maintainability are discussed. Design goals, principles, and advantages are presented. Specific design applications and examples of the benefits accruing from standardization and interchangeability are given for several commodity areas. Sources of information relative to the Army supply system are detailed. Checklists for standardization and interchangeability are included.*

#### 3-0 LIST OF SYMBOLS

- $A = (100,000/1000)^{0.3} = 3.98$   
 $a$  = ammunition supply standard error, rounds/day  
 $B = (100,000/1000)^{-0.3} = 0.251$   
 $b$  = ammunition demand standard error, rounds/day  
 $D$  = buffer supply, i.e., number of items on hand when reordering, dimensionless  
 $k$  = integer shape parameter for distributions of service times, dimensionless  
 $MTBM$  = observed mean time between maintenance at 1000 h, h  
 $(MTBM)'$  = projected mean time between maintenance actions at 100,000 h, h  
 $MTTR$  = observed mean time to repair at 1000 h, h  
 $(MTTR)'$  = projected mean time to repair at 100,000 h, h  
 $(P_{NORS})_{2 \ 1.2}$  = probability of not operational ready, supply for 2 1/2-ton truck, dimensionless  
 $(P_{NORS})_5$  = probability of not operational ready, supply for 5-ton truck, dimensionless  
 $Q$  = number of repair items ordered, dimensionless  
 $S(t)$  = probability of completions of repair operations in time  $t$ , dimensionless  
 $s$  = standard deviation, h  
 $T$  = stock replenishment time, day  
 $T_s$  = mean duration of repair-operations, h  
 $t$  = time, h  
 $\bar{X}$  = mean, h  
 $\bar{X}_d$  = average ammunition demand, rounds/day  
 $\bar{X}_s$  = average ammunition supply, rounds/day  
 $Z_n$  = normal, standard test statistic, dimensionless  
 $\lambda$  = rate of replacements, replacements/day  
 $\mu = 1/T_s =$  mean service rate,  $h^{-1}$

#### 3-1 INTRODUCTION

Contributing maintainability factors are those—other than the prime factors of diagnostics, accessibility, throwaway modular design, etc. that have a significant effect on the maintainability of a system. Some of the contributing factors are prerequisite to consideration of the prime factors, some directly affect system maintainability without influencing any of the prime factors, a few affect system maintainability indirectly, and some have an across-the-board effect. Standardization and interchangeability are two important contributing factors in the across-the-board category.

#### 3-2 STANDARDIZATION

The chapter title, “Standardization and Interchangeability”, is used to emphasize the interrelationship between the two factors. Interchangeability as a maintainability design factor is closely related to standardization in that it is one of the principal means by which standardization is realized. Good examples of the close standardization interchangeability relationship are the standard size base for incandescent lamps and the standard size male plug of electrical appliances. If these sizes were a function of their source of design or manufacture, a chaotic condition would exist. A worst case example is the infinity of shapes, sizes, and materials of construction of washers for household water faucets. Interchangeability is recognized as a design factor in its own right and is discussed in par. 3-3.

The definition of standardization includes more than parts—i.e., based on the glossary definition, engineering terms, principles, practices, materials, processes, etc., are included. For this discussion, however, standardization will be limited to parts, i.e., physical items. This leads to the definition “Standardization is a design feature for restricting to a minimum the feasible variety of parts which will meet the hardware requirement within the Army and Department of Defense (DoD) inventories.”. Thus standardization encourages the use of common items—e.g., the Army uses common items such as Army-Navy (AN) and Military Standard (MS) couplings, truck

## DOD-HDBK-791(AM)

tire sizes, and common materials for uniforms and canvas coverings.

Standardization is mandated by DoD Directive No. 4120.3 (Ref. 1) and implemented by DoD Instruction No. 4120.19(Ref. 2) (see par. 3-5); however, the main impetus derives from the willingness of engineers and program managers to use existing equipment to satisfy their particular need.

### 3-2.1 DESIGN GOALS AND PRINCIPLES

Standardization was previously defined as a design feature for restricting to a minimum the variety of parts that will meet the majority of the hardware requirements of the system. According to (Ref. 1), it is important that maintainability engineers strive for the design of assemblies and components for a given system that are physically and functionally interchangeable with other like assemblies and components of the system. The importance of standardization, a major consideration of maintainability design, translates into achieving the following primary goals:

1. Minimizing both the acquisition and support costs of a system
2. Increasing the availability of mission-essential items
3. Reducing training requirements both in number of personnel and the level of skill required
4. Reducing inventories of repair parts and their associated documentation.

In any attempt to achieve standardization, the following principles must be carefully considered:

1. Make maximum use of all common parts and assemblies.
2. Reduce to a minimum the variety of assemblies and parts required, and, in doing so, make certain that the basic types are
  - a. Used consistently for each application
  - b. Compatible with existing uses and practices.
3. Reduce to a minimum, by careful study of the simplification thus attained, the problems of supply, storage, and stocking.
4. Simplify practices, by the same means, in the coding and numbering of parts.
5. Make maximum use of "off-the-shelf" components, tools, and test equipment.

### 3-2.2 ADVANTAGES

When standardization is carried to the practical maximum in system design, certain major advantages are gained by the support activities required for the completed system, i.e.,

1. Both the types and quantities of repair parts normally are reduced and required parts are usually available; this reduces overall support costs.

2. Training requirements for support personnel are reduced, principally by the simplification of circuits and functions; moreover, the number and skills of support personnel required also are reduced because the technicians are working with familiar items.

3. Similarly, requirements for technical publications are greatly reduced in quantity as well as in the amount of detail covered.

4. The variety and quantities of test equipment required to support a system are reduced.

5. In general, standardization design will reduce the need for support facilities at all levels of maintenance.

Despite the advantages offered by standardization, a system should not necessarily be built around a standard item—particularly if the standard item does not meet the performance standards or has a record for poor reliability or costly maintenance; or the standard item may satisfy a safety requirement in most environments but not in the unusual environment for which it is being considered. Technological advances dictate the development of new material or provide a superior product to replace an existing one—e.g., an integrated circuit for a transistor or a vacuum tube—cannot be ignored or discarded. Therefore, a standard item, either for design or retrofit, should be initially considered because of its obvious benefits; then the reasons for rejecting the standard item and designing a new part should be assessed—the use of a standard part is advocated, but it is secondary to the prime objective of the development.

## 3-3 INTERCHANGEABILITY

### 3-3.1 GENERAL

Interchangeability exists when two or more parts are physically and functionally interchangeable in all possible applications—i.e., when the parts are capable of full, mutual substitution in all directions. Functional interchangeability is attained when a part or unit, regardless of its physical specifications, can perform the specific functions of another part or unit. Physical interchangeability exists when any two or more parts or units made to the same specification can be mounted, connected, and used effectively in the same position in an assembly or system.

There are two broad classes of interchangeability:

1. *Universally Interchangeable.* Parts that are required to be interchangeable in the field even though manufactured by different facilities

2. *Locally Interchangeable.* Parts that are interchangeable with other components made by the same facility but not necessarily interchangeable with those made in other facilities. Local interchangeability usually results from the different set of measurement units employed in design and manufacture—a condition that could result from the implementation of the Rationalization, Standardization, and Interoperability (RSI) Pro-

gram within the North Atlantic Treaty Organization (NATO), which is discussed in par. 3-2.2. The US Allies usually employ the International System of Units (SI), i.e., metric units. Even though DoD Directive No. 4120.18 (Ref. 3) established a policy to consider the use of the metric system in all of its activities consistent with operational, economical, technical, and safety requirements. materiel fielded prior to 1976 is still in the US and NATO inventories and new equipment being fielded is still not metric. Ref. 4 presents a thorough discussion of the SI system and contains a comprehensive list of conversion factors for transferring from one system to the other. Software programs are available to facilitate the conversion.

### 3-3.2 RATIONALIZATION, STANDARDIZATION, AND INTEROPERABILITY (RSI) PROGRAM

The RSI Program was established by DoD Directive No. 2010.6 (Ref. 5). The overall objective of the program was to achieve improved NATO operational effectiveness and combat capability by means of

1. *Rationalization.* Any action that increases the effectiveness of NATO forces through more efficient or effective use of defense resources committed to NATO, including both codevelopment and coproduction of NATO Standard Weapon systems

2. *Standardization.* The process by which nations achieve the closest practicable cooperation among forces; the most efficient use of research, development, and production resources; and agreement to adopt on the broadest possible base the use of common or compatible procedures. equipment, and tactical doctrine

3. *Interoperability.* The ability of systems, units, or forces to provide services to, and accept services from, other systems. units, or forces and to use the services so exchanged to enable them to operate effectively together.

Standardization if and when ever attained would ensure a major increase in the operational capability of NATO forces. Total standardization within NATO would overcome the present advantage of the Warsaw Pact forces in that their weapons and support systems are essentially standard throughout the Pact. The forces of the Pact countries currently possess a high degree of standardization because of the unique situation that limits their source of weapons, ammunition, and follow-on supplies.

It is interesting to note that the National Codification Bureau Code (NCBC) identifies 24 allied country codes stored in the Defense Logistics Services Center (DLSC) (Ref. 6); this fact indicates that standardization is emerging even though it may be limited to such items as tires and storage batteries. The national stock number, of which NCBC and DLSC are an integral part, is discussed in par. 3-5.

### 3-3.3 DESIGN PRINCIPLES

To attain maximum interchangeability, the following design principles apply:

1. Functional interchangeability of parts and units should exist wherever physical interchangeability exists to avoid a dangerous situation.

2. Physical interchangeability should not exist whenever functional interchangeability is not intended.

3. Whenever complete functional and physical—interchangeability is impractical, the parts and units should be designed for functional interchangeability, and adapters provided to make physical interchange possible.

4. To remove latent doubts, sufficient information should be provided undocumented instructions and identification plates to enable the technician to decide positively whether or not two similar parts or units are actually interchangeable.

5. Differences should be avoided in the shape, size, mounting, and other physical characteristics of functionally interchangeable units.

6. Modifications of parts and units should not change the manner of mounting, connecting, and otherwise incorporating them into an assembly or system.

7. Complete interchangeability should be provided for all parts and units that

a. Are intended to be identical

b. Are identified as being identical

c. Have the same manufacturer's part number or other identification

d. Have the same function in different applications—this is especially important for parts and units that have a high failure rate.

8. Parts, fasteners and connectors, lines and cables, etc., should be standardized throughout a system, particularly from unit to unit within the system.

9. Mounting holes and brackets should be made to accommodate parts and units made by different facilities—i.e., make them universally interchangeable.

### 3-3.4 ADVANTAGES

The advantages to be gained from effective interchangeability are essentially the same as those gained by standardization (see par. 3-2.2). In addition, the provision of interchangeability is essential to effective standardization. The greatest advantage is gained when parts are both standardized and interchangeable.

### 3-4 DESIGN APPLICATIONS

Areas that are well suited to standardization and interchangeability include operating and physical characteristics, as well as equipment types. Standard parts, components, circuits, methods, and practices should be used in the following applications:

1. Voltage and/or current levels, input or output,

## DOD-HDBK-791(AM)

for circuits

2. Values of regulators and supply voltages
3. Arrangement and packaging schemes
4. Part identification
5. Labeling and marking
6. Wire identification and coding
7. Selection and mounting of covers and cases
8. Selection and application of fasteners
9. Materials for servicing—e.g., greases, lubricating oils, hydraulic fluids, and fuels
10. Selection of items that have an identical purpose in many applications—e.g., starting motors; alternators; air, oil, and fuel filters; batteries; tires; radiators; drive belts; and instrument lights
11. Selection of standard sizes and gages of materials
12. Design of units that are symmetrical relative to a centerline to eliminate the necessity for right- and left-handed parts—e.g., a split console cover.

A well-planned standardization and interchangeability strategy will

1. Reduce requirements for special and close tolerance parts
2. Save manufacturing cost, and maintenance time and cost
3. Result in more uniformity and predictable reliability and maintainability
4. Minimize the danger of misapplication of parts and assemblies
5. Prevent accidents that may arise from improper or confused procedures
6. Reduce errors in wiring, installation, and replacement due to the consistency in the physical layout and configuration of similar equipment
7. Provide for the testing of many items with a minimum of standard test equipment.

In addition, the problems associated with procuring and maintaining adequate inventories of parts will be reduced, the required documentation associated with increased part lists will be lessened, and the number and expertise of technicians will be reduced.

### 3-5 EXAMPLES OF BENEFITS OF STANDARDIZATION/ INTERCHANGEABILITY

Three examples are presented, i.e.,

1. An increased confidence level -the result of using a standard item -in performing a maintenance action within a specified time. (See Example 3-1.)
2. Use of an item with an excellent track record for reliability which has demonstrated that the original estimated mean time between failures can be increased and that the original estimated mean time to repair can be decreased. (See Example 3-2.)
3. Improved logistic support through interchangeability. (See Examples 3-3 and 3-4.)

Example 3-1;

Maintenance is usually illustrated by an inherent repair timed distribution (see par. 1-3.1). As indicated in Fig. 1-1, a more skilled and disciplined repair crew can perform a repair action in a shorter mean time and with a reduced variance. This suggests that repair actions of a repetitive type on items subject to rapid deterioration, e.g., connectors and seals, can be accelerated by the use of standard repair parts. The reduced variance is a logical expectation because familiarity with an operation should lead to consistency, i.e., a “tighter” distribution curve. Fig. 3-1 (Ref. 7) illustrates quantitatively the effect of a reduction in variance in time distributions resulting from the use of a standard set of items in a repair operation where the mean of every distribution was reduced to unity. Here the integer shape parameter  $k$  for the distribution of service items is defined as

$$k = \bar{X}^2/s^2, \text{ dimensionless} \quad (3-1)$$

where

$\bar{X}$  = mean, h

$s$  = standard deviation, h

or since  $\bar{X} = 1$

$$k = 1/s^2, \text{ dimensionless.} \quad (3-2)$$

To illustrate the relationship between  $k$  and  $s^2$  assume  $k = 4$ ; therefore, from Eq. 3-2,

$$s^2 = \frac{1}{k} = \frac{1}{4} = 0.25 \text{ h}$$

or the standard deviation is

$$s = \sqrt{0.25} = 0.5$$

i.e., a mean repair time equal to twice the standard deviation. With a  $k = 20$ , the mean repair time is 4.5 times the standard deviation, i.e., a “tighter” distribution curve.

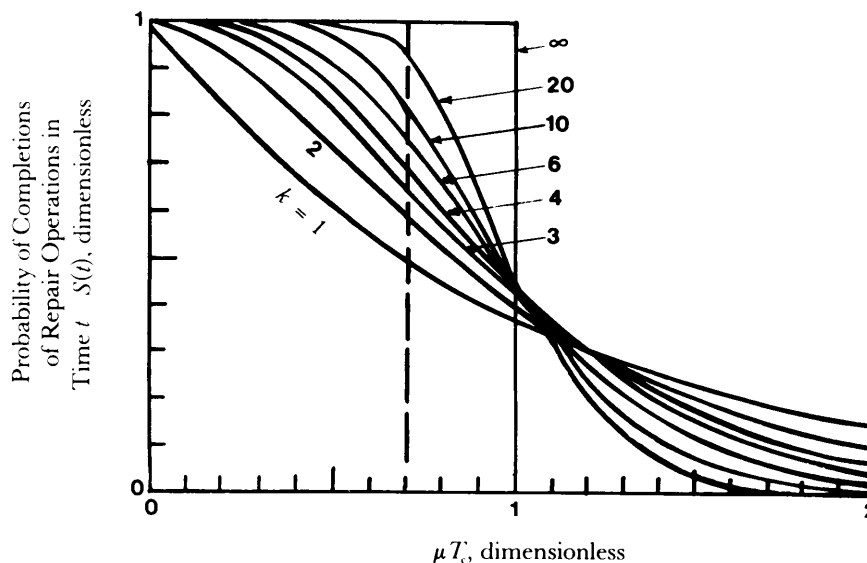
The definitions of other parameters to interpret Fig. 3-1 follow:

$S(t)$  = probability of completion of repair operations within time  $t$ , dimensionless

$T_s$  = mean duration of repair operations, h

$\mu = 1/T_s$ , mean service rate,  $\text{h}^{-1}$

Assume a fixed interval of  $\mu T_s = 0.7$  units is available for repair, then the points at which the dotted line in Fig. 3-1 intercepts the A-distributions indicate the probability of completions of repair actions e.g., for  $k = 2$ ,  $S(t) = 0.5$ ; for  $k = 20$ ,  $S(t) = 0.95$ .



Reprinted with permission of John Wiley & Sons, Inc., from *Queues, Inventories and Maintenance* by Philip M. Morse. Copyright © by John Wiley & Sons, Inc., 1958.

**Figure 3-1. Typical Maintenance Distributions (Ref. 7)**

*Example 3-2:*

A previously used component should be well advanced in both the reliability and maintenance learning curves. Therefore, an item with demonstrated improved reliability and reduced maintenance should be considered where possible. To illustrate this point, consider the T700 gas turbine that was developed for the BLACK HAWK Utility Helicopter program. Because of the excellent in-service performance of the T700 turbine, it was selected to power the Advanced Attack Helicopter (AAH) (Ref. 8). Assume (1) a geometric distribution for the learning curves for both mean time between maintenance actions (*MTBM*) and mean time to repair (*MTTR*) with a conservative *MTBM* slope of 0.3 and an *MTTR* slope of -0.3, and (2) 100,000 h of learning have been accumulated with the T700 turbine when the AAH is introduced into the field. With experience, the *MTBM* should increase due to improved reliability resulting from improved manufacturing techniques and changes in design, and the *MTTR* should decrease due to a greater familiarity with the maintenance process. The improved (*MTBM*)' and (*MTTR*)' can be calculated by

$$(MTBM)' = A(MTBM), \text{ h} \quad (3-3)$$

$$(MTTR)' = B(MTTR), \text{ h} \quad (3-4)$$

where

(*MTBM*)' = projected mean time between maintenance actions at 100,000 h, h

*MTBM* = observed mean time between maintenance at 1000 h, h

(*MTTR*)' = projected mean time to repair at 100,000 h, h

*MTTR* = observed mean time to repair at 1000 h, h

$$A = (100,000/1000)^{0.3} = 3.98$$

$$B = (100,000, 1000)^{-0.3} = 0.251.$$

Given *MTBM* = 0.8 h and *MTTR* = 3.6 h, the projected times can be calculated by Eqs. 3-3 and 3-4, respectively,

$$(MTBM)' = 3.98(0.8) = 3.2 \text{ h}$$

$$(MTTR)' = 0.251(3.6) = 0.9 \text{ h}.$$

As expected, the (*MTBM*)' increased and the (*MTTR*)' decreased, i.e.,

	1000 h	100,000 h
mean time between maintenance actions	0.8 h	3.2 h
mean time to repair	3.6 h	0.9 h.

*Example 3-3:*

The logistic support of equipment can be improved through standardization and interchangeability. For example, in the wheeled commodity area, a young commander in Vietnam took maximum advantage of the interchangeability of the 2½- and 5-ton truck engines to return equipment to the field in the shortest possible time (Ref. 9). The calculations that follow illustrate this case.

Assume that different engines are used for different truck sizes and that a time *T* of 60 days is required to receive a new stock of engines after placing an order. Also

## DOD-HDBK-791(AM)

assume the following data for this example:

	2 1/2-ton Truck Engine	5-ton Truck Engine	Standard Engine
$Q$	4	3	7
$D$	2	1	3
$T$ , day	60	60	60
$\lambda$ , day <sup>-1</sup>	1/10	1/20	1/10, 1/20 for 1/2-ton truck and 5-ton truck, respectively

where

- $Q$  = number of repair items ordered, dimensionless
- $D$  = buffer supply, i.e., number of items on hand when reordering, dimensionless
- $T$  = stock replenishment time, days
- $\lambda$  = rate of replacements, replacements/day.

The probability  $P_{NORS}$  of not operational ready, supply, is given by (Ref. 7)

$$P_{NORS} = \frac{(\lambda T)^{D+1}}{2Q(1 + \lambda T)^D + (\lambda T + D - Q)(\lambda T)^D},$$

dimensionless. (3-5)

By use of Eq. 3-5 and the given data. the ( $P_{NORS}$ ), are

	With Different Engine	With Standard Engine
$(P_{NORS})_{2 \ 1/2}$	0.403	0.248
$(P_{NORS})_5$	0.333	0.093.

From the data it is obvious that the use of standard engines improves operational readiness.

### Example 3-4:

In the small arms commodity area, much of the NATO weaponry has been standardized at 7.62 mm (for personnel, combat vehicles, and aircraft). This type of standardization increases the availability of small arms ammunition. Since the number of small arms rounds expended is extremely large, a normal distribution can be assumed and used to evaluate the benefits of a standard ammunition size. Assume that the supply of 7.62-mm ammunition averaged 100,000 rounds per day with a 30,000-round standard error and demand averaged 80,000 rounds per day with a 20,000-round standard error. A standard normal test statistic  $Z_n$  can be determined by (Ref. 10)

$$Z_n = \frac{\bar{X}_s - \bar{X}_d}{\sqrt{a^2 + b^2}} \quad (3-6)$$

where

- $\bar{X}_s$  = average ammunition supply, rounds/day
- $\bar{X}_d$  = average ammunition demand per day, rounds/day
- $a$  = ammunition supply standard error, rounds/day
- $b$  = ammunition demand standard error, rounds/day.

With the given data and Eq. 3-6, calculate  $Z_n$

$$Z_n = \frac{100,000 - 80,000}{\sqrt{(30,000)^2 + (20,000)^2}} = 0.55.$$

By referring to a Normal Probability Table with  $Z_n = 0.55$ . the probability that demand exceeds supply is 29%.

Now, assume that both the supply and demand double, and for the sake of simplicity, also assume that the standard errors double. Then  $Z_n$ , becomes

$$Z_n = \frac{2(100,000) - 2(80,000)}{\sqrt{2(30,000)^2 + 2(20,000)^2}} = 0.785$$

and the probability that demand exceeds supply is reduced to 22%. This illustrates how a large inventory of common items will reduce the probability supply will exceed demand.

## 3-6 SOURCES OF INFORMATION

The reluctance exhibited by the designer to use existing parts and standard items is not the result of indifference to the program; rather, it can be attributed to ignorance about the sources of information. Consequently, various information sources that support standardization and interchangeability are discussed, i.e..

1. DoD Instruction 4120.19, *Department of Defense Parts Control Program*
2. A R 700-60. *Department of Defense Parts Control Program*
3. MIL-STD-965. *Parts Control Program*
4. MIL-STD-143, *Standards and specifications, Order of Precedence for the Selection of*
5. *Department of Defense Index of Specifications and Standards (DODISS)*
6. *Qualified Products List*
7. *Army Master Data File*
8. *Identification List*
9. *National Stock Number*
10. *Test, Measurement, and Diagnostic Equipment (TMDE).*

Each of these information sources is discussed in the paragraphs that follow.

**3-6.1 DoD INSTRUCTION NO. 4120.19,  
DEPARTMENT OF DEFENSE PARTS  
CONTROL PROGRAM**

This instruction assigns “responsibility for implementing the DOD Parts Control Program as an integral part of the acquisition process for the support of systems, subsystems, and equipment by the DOD” (Ref. 2).

The objective of this instruction is to “conserve resources and to reduce life cycle cost by reducing the varieties of component parts; promoting the application of established or multiuse items of known performance during the design, development, production or modification of equipments and weapon systems; and applying techniques to assist system or equipment acquisition managers and their contractors in the identification and selection of established or multi use parts to enhance inter- or intradepartmental system commonality, interchangeability, reliability, maintainability, standardization, and interoperability” (Ref. 2)

**3-6.2 AR 700-60, DEPARTMENT OF  
DEFENSE PARTS CONTROL  
PROGRAM**

This Army regulation provides for the implementation of DoD Instruction No. 4120.19 and sets forth the Army policy and establishes responsibilities for Army participation in the mandatory DoD Parts Control Program (PCP) and for the use of advisory support services of Military Parts Control Advisory Groups (MPCAGs) (Ref. 11).

The function of the MPCAGs is “to provide Army Elements and their assigned contractors engineering advice and recommendations for assigned Federal Supply Classes (FSC) on the selection and use of parts during the design, development, production, and modification of systems, subsystems, and equipment. Decision authority

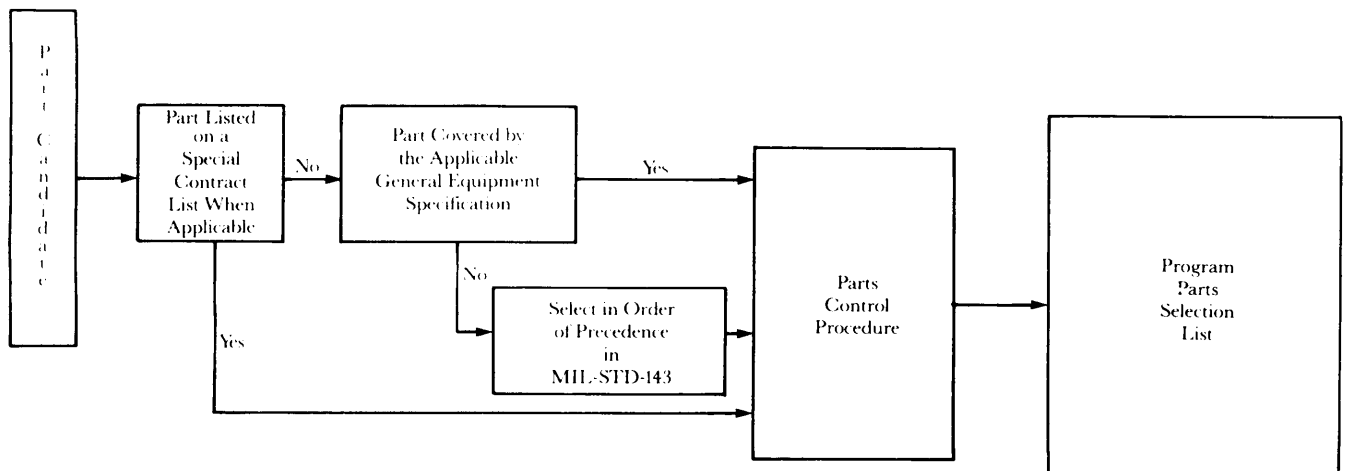
for the selection and use of parts rests with the Army elements responsible for the acquisition and support of the system, subsystem, or equipment” (Ref. 11).

**3-6.3 MIL-STD-965, PARTS CONTROL  
PROGRAM**

Since this is the first time the term “Military Standard” has been introduced, it may be expedient to define the term to distinguish it from “Military Specification”. A military standard is a document that establishes engineering and technical requirements for items, equipments, processes, procedures, practices, and methods that have been adopted as standard. Standards may also establish requirements for selection, application and design criteria for materiel (Ref. 12). In contrast, a military specification for the same item describes it in terms of the requirement for procurement.

MIL-STD-965 (Ref. 13) establishes guidelines and requirements for the implementation of a parts control program, and it is applicable to both new designs or modifications. The standard emphasizes that the contractor must develop a proposed Program Parts Selection List (PPSL) in which the number of different part types is minimized and the use of standard parts is maximized. When standard parts cannot be selected, nonstandard parts are to be selected from documents in accordance with the order of precedence of MIL-STD-143 (Ref. 14). An example of the selection process is shown in Fig. 3-2.

- MIL-STD-965 (Ref. 13) describes the function of the
1. Parts Control Board (PCB), a formal organization established by the contract to assist the prime contractor in controlling the selection and documentation of parts used in equipment, systems, or subsystems.
  2. Military Parts Control Advisory Group (MPCAG), a DoD organization that provides advice to the military departments and military contractors on the selection of



**Figure 3-2. Example for Selection of Parts for Program Parts Selection List (PPSL) (Ref. 13)**

## DOD-HDBK-791(AM)

parts in assigned commodity classes and collects data on nonstandard parts for developing or updating military specifications and standards.

### 3-6.4 MIL-STD-143, STANDARDS AND SPECIFICATIONS, ORDER OF PRECEDENCE FOR THE SELECTION OF

MIL-STD-143 (Ref. 14) establishes the order of precedence for the selection of standards and specifications to identify and describe items, materials, and processes used by design activities in the design and production of materiel. The standard indicates that design and application considerations—i.e., function, environment, reliability, maintainability, strength, safety, and interchangeability as well as economic factors shall govern the selection and use of materials.

### 3-6.5 DEPARTMENT OF DEFENSE INDEX OF SPECIFICATIONS AND STANDARDS (DODISS)

The DODISS (Ref. 15) is an indispensable publication in the pursuit of implementing a standardization program. The DODISS is issued bimonthly—in hard copy and in microfiche by alphabetical and numerical listing. The publication lists the unclassified Federal, Military, and Departmental specifications, standards, and related standardization documents and those Industry documents that have been coordinated for DoD use, i.e.,

1. Military Specifications
2. Military Standards
3. Federal Specifications and Commercial Item Descriptions
4. Federal Standards
5. Federal Information Processing Standards
6. Qualified Products List
7. Industry Documents
8. International Standardization Documents
9. Military Handbooks
10. Air Force-Navy Aeronautical Standards
11. Air Force-Navy Aeronautical Design Standards
12. Other Departmental Documents
13. Military/Air Force-Navy AERO Bulletins
14. Air Force Specification Bulletins.

The DODISS can be obtained as follows:

1. For Military Activities:  
Commanding Officer  
Naval Publications and Forms Center (NPFC  
105)  
5801 Tabor Avenue  
Philadelphia, PA 19120-5099
2. For Government Civil Agencies and Non-Government Activities (subscription basis only):  
Superintendent of Documents  
US Government Printing Office  
Washington, DC 20402.

### 3-6.6 QUALIFIED PRODUCTS LIST (QPL)

The Qualified Products List (QPL) is a list of products that have met the qualification requirements stated in the applicable specification, including appropriate product identification and test or qualification reference with the name and plant address of the manufacturer and distributor, as applicable (Ref. 16). To establish a QPL, an approved and dated military or Federal specification must exist that sets forth the qualification examination, tests, and criteria for retention. Ref. 15 contains a list of QPLs and standards.

QPLs are identified by the symbol “QPL” followed by the number of the associated specification and an issue number to identify the issue of the QPL, e.g., “QPL-8952-1” identifies the initial issue of the QPL associated with military specification MIL-B-8952. *Bearing, Roller, Rod End, Antifriction Self-Aligning*. For Federal specifications, both the specification symbol and number are used, e.g., “QPL-ZZ-T-381-2” identifies the second issue of the list associated with Federal specification ZZ-T-381. *Tire, Pneumatic, Vehicular (Highway)*. Specification revision indicators are not used in the QPL number.

### 3-6.7 ARMY MASTER DATA FILE (AMDF)

The AMDF (Ref. 17) is another indispensable publication (microfiche) since it is the official source of current supply management data for the items managed or used by the Department of the Army (DA). Items are listed by National Stock Number (NSN); the interpretation of the codes associated with the listing is found in Ref. 18. The data have precedence over conflicting data published in any other DA publication except for items within the purview of SB 700-20, *Army Adopted/Other Items Selected for Authorized/List of Reportable Items*.

Copies of AMDF can be obtained from  
Commander  
USAMC Catalog Data Activity  
ATTN: AMCA-PP  
New Cumberland Army Depot  
New Cumberland, PA 17070-5010.

### 3-6.8 IDENTIFICATION LIST (IL)

The IL is arranged by Federal Supply Class (FSC) groupings (see Ref. 19 for groups and classes) and contains descriptions of all active items in the Defense Logistics Services Center (DLSC). Data elements reflect related characteristics and or reference number. The principal uses of the IL are to obtain or verify a National Stock Number (NSN) when only the characteristics of an item are known, to assist in determining interchangeable and substitute items, and to obtain data when the NSN is known.

The ILs contain proprietary information and are for Government use only. Army installations may obtain

microfiche copies of the ILs by mailing a completed DA Form 12-21 to

Commander  
 US Army AG Publications  
 ATTN: AGDL-ODR  
 1655 Woodson Road  
 St. Louis, MO 63114.

**3-6.9 NATIONAL STOCK NUMBER (NSN)**

During World War II the military services' supply systems were fraught with problems. For example, each of the services operated several different supply systems. Within the Army alone there were eight Technical Services, each operating an independent supply system with different stock numbering methods, different specification guides for identical items, different supply catalog formats, and different descriptive languages. It is obvious that the system resulted in waste, inefficiency, and lack of standardization.

The Defense Cataloging and Standardization Act, enacted in 1952, resulted in a Government-wide system jointly administered by the DoD and the General Services Administration (GSA). The Act required "the use of common supply language for naming, identifying, and describing each item repetitively used, purchased, or stocked for distribution by the DoD". The Act also required the development of a unique stock numbering system to identify each item, part, assembly, or component so it could be distinguished from another. The resulting system, called the Federal catalog system, is a complex structure that provides services to users world-wide-military services, other DoD components, NATO, friendly foreign governments, and private sector contractors doing business with the US Government. Thus the Federal catalog system supports logistic functions such as maintainability concepts, repair part management, and procurement.

The net result of the Act was the evolution of a national stock number (NSN) that identifies an item throughout its entire life cycle in the Federal catalog system. The NSN is the means of access to the various part lists previously

described. The NSN structure consists of 13 digits (see Fig. 3-3). The first four digits comprise the Federal supply classification (FSC) code as listed in Ref. 19; the last nine digits are the national item identification number (NIIN). The NIIN is subdivided into a 2-digit National Codification Bureau Code (NCBC) and a 7-digit item identification number sequentially assigned by the Defense Logistics Service Center (DLSC). Presently, there are 24 country codes stored in the DLSC data bank (Ref. 6).

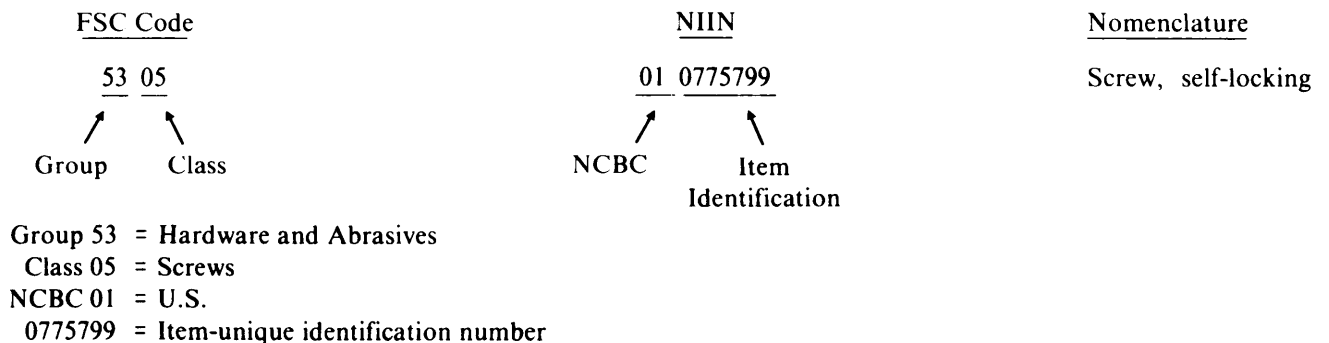
AR 708-1 (Ref. 20) directs that items in the Army supply system will not be ordered by commercial part numbers, i.e., the numbers that commercial firms use to identify items of their manufacture. The DLSC has been directed to assign an NSN to every standard item in the Army supply system. To ensure that items do not enter the Army supply system without an NSN, the Army Materiel Command (AMC) had the DLSC assign NSNs automatically to all items authorized for central stock age at the wholesale level. NSNs are also to be listed in part manuals, and part number-to-NSN cross-reference charts are to be issued with commercial manuals before releasing new equipment to the field (Ref. 21).

For improved standardization and parts reduction, it is obvious that the maintainability engineer must be aware of the NSN and the information that it conveys.

**3-6.10 TEST, MEASUREMENT, AND DIAGNOSTIC EQUIPMENT (TMDE)**

**3-6.10.1 General**

The necessary maintenance operations and characteristics of equipment determine TMDE requirements. To neglect considering TMDE requirements until equipment design and maintenance procedures are finalized may result in the demand for many special tools or an unnecessarily wide variety of standard tools and test equipment. Designers have a tendency to design equipment with proprietary TMDE. Further, they tend to assume that the TMDE in their design facilities will be available at the point of use. In fact, such devices, when provided, perform poorly in the hands of lower level technicians and



**Figure 3-3. NSN Configuration**

## DOD-HDBK-791(AM)

constitute an extra maintenance burden on the system. It is not necessary to specify a \$2000 oscilloscope to measure a  $\pm 5V$  on a digital circuit.

### 3-6.10.2 AR 750-43, *Test, Measurement, and Diagnostic Equipment*

To bring order out of chaos, AR 750-43 was published. This Army Regulation (AR) (Ref. 22) prescribes policies, establishes objectives, and priorities, and assigns responsibilities for the life cycle management of TMDE. It aligns with directives and instructions developed and published by the Maintenance Policy Directorate, office of the Assistant Secretary of Defense for Manpower, Reserve Affairs, and Logistics. Primary DoD publications that apply to the contained policies are DoD Instruction No. 4100.40 and DoD Directive No. 4151.16. AR 750-43 also names the Commanding General, US Army Materiel Command (AMC), as the Department of the Army Executive Director for TMDE (EDT) responsible for developing and recommending TMDE policy to Headquarters, Department of the Army—i.e., the central management of all TMDE support to ensure peacetime readiness while providing a smooth transition to wartime support. The procedure by which AMC executes this TMDE responsibility is described in par. 3-6.10.3.

### 3-6.10.3 AMC's Role as Executive Director

AMC, through the US Army TMDE Support Group (USATSG), places the TMDE calibration and repair under a central manager. The TMDE support missions and resources of all Army major commands, except the Surgeon General, are under the control of the USATSG. A major benefit of this central management has been the ability to compile and assess detailed requirements and performance data and to apply these data on a timely basis to manage resources. This has led to optimum use of

available resources and major reductions in planned wartime personnel and equipment requirements.

An Army Test Program Sets (TPS) program (Ref. 23) has been completed, which focuses on the development and management of TPS. The two most important elements of the program are the

1. TPS management plan that requires the system developer to formalize the approach

2. The procedures manual that provides the TPS development and management guidance necessary for an efficient approach to TPS.

Other elements of the TPS program are cost modeling research, a formal TPS data base, a TPS education source, and a computer-aided technical support environment.

The improved Army TMDE acquisition management efforts are reflected in emphasis on informed participation in DA TMDE Preferred Items List (PIL) (see par. 3-6.10.4); In-Process Review panel plans and actions; publication of significant TMDE news through the quarterly *TMDE Equipment Reports and Maintenance Digest*; and through improvements in the published DA TMDE PIL, *Register*, and *Register Index*.

### 3-6.10.4 DA TMDE Preferred Items List (PIL)

This PIL is a catalog of the most up-to-date standard Army TMDE currently type classified and reportable. The PIL is maintained by the US Army Central TMDE Activity under the direction of the FDI. The PIL is used as the preferred acquisition guideline for the procurement of Army TMDE. PIL policy, candidates, criteria, and objectives are described in DA Pam 700-12-1 (Ref. 24).

The direction of flow representing the order of priority and preference to be exercised in the selection of required TMDE, together with the role of the PIL, is shown in Fig. 3-4.

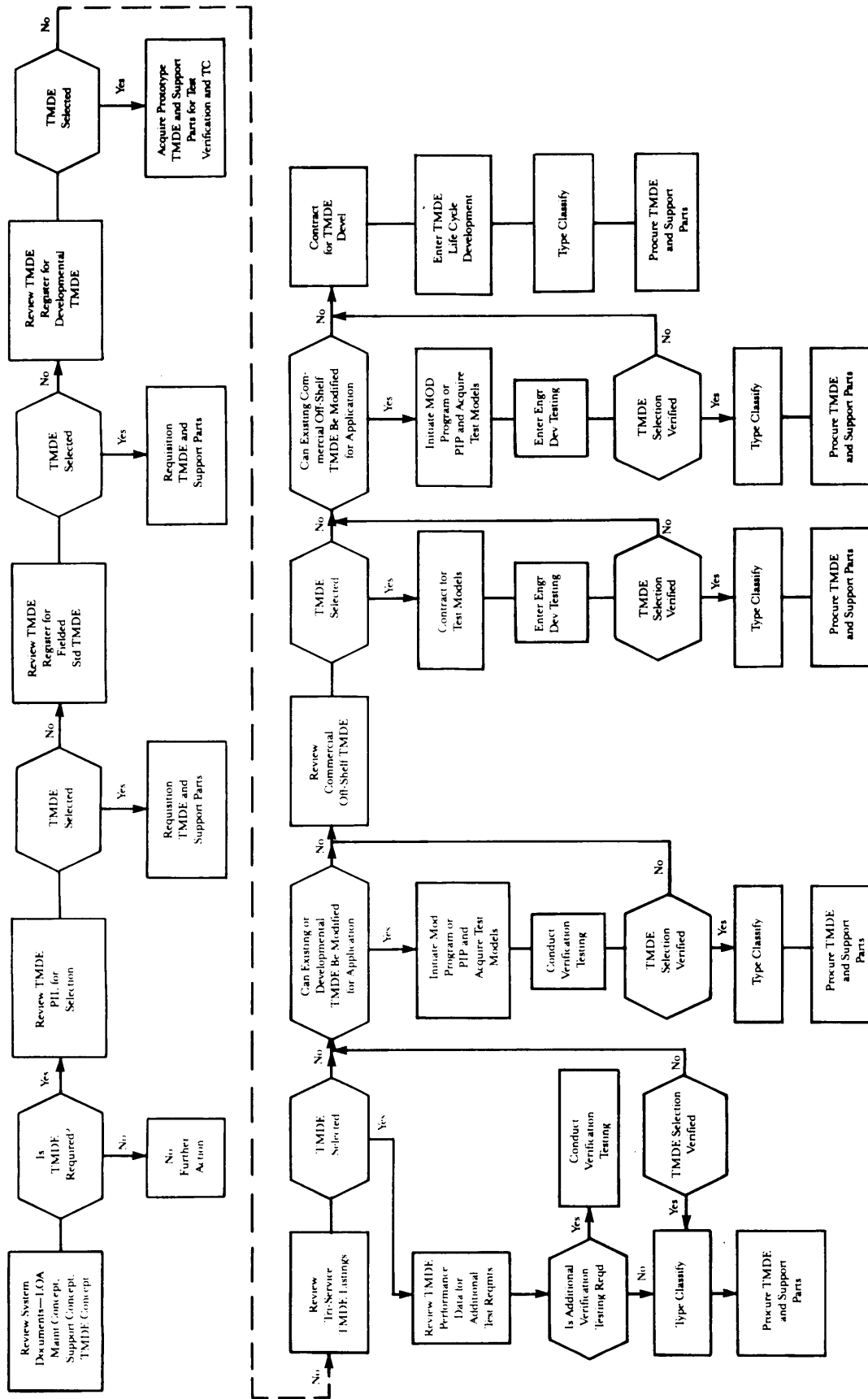


Figure 3-4. TMDE Selection Flow Chart (Ref. 23)

**3-7 STANDARDIZATION AND INTER-  
CHANGEABILITY CHECKLISTS**

Tables 3-1 and 3-2 checklists for standardization and interchangeability, respectively—are for use in evaluating

the design of an item. If an answer is "no" for any question on the checklists, the design should be restudied to determine whether correction is required.

**TABLE 3-1. STANDARDIZATION CHECKLIST**

1. Have all sources of standardization information been searched for common items, materials, and practices?
2. Has each requirement for a tool or item of ground support equipment (GSE) been analyzed to determine whether the need can be eliminated or the tool made common with those already used?
3. Do designs and practices make use of the SI of measures where required?
4. Have special manufacturing techniques been avoided or minimized?
5. Are materials, processes, and components covered by Military Specifications? Is a QPL available?
6. Can standard circuits be used that will also be compatible with standardized test equipment?
7. Are circuit types kept to a minimum?
8. Are identical parts used wherever possible in similar equipment or in a series of a given type, such as using the same piston and cylinder for a series of internal combustion engines?
9. Are parts, fasteners, connectors, lines, cables, etc., standardized throughout the system, particularly from unit to unit within the system?

**TABLE 3-2. INTERCHANGEABILITY CHECKLIST**

1. Does functional interchangeability exist where physical interchangeability is possible?
2. Does complete interchangeability exist wherever practical?
3. Is sufficient information provided on identification plates and within technical manuals to enable the user to decide whether two similar parts are interchangeable?
4. Are differences in size, shape, and mounting of components encouraged to eliminate the suggestion that parts may be functionally interchangeable?
5. Is complete interchangeability provided for all items intended to be identical, interchangeable, or designed to serve the same function in different applications?
6. Do mounting holes and brackets accommodate units of different makes, such as engines of the same type and horsepower, built by different manufacturers?
7. Are cable harnesses designed so that they can be fabricated in a factory and installed as a unit?
8. Is complete electrical and mechanical interchangeability provided on all like removable components?
9. Are bolts, screws, and other features the same size for all covers and cases on a given piece of equipment?
10. Is interchangeability provided for components having a high mortality?
11. Where complete interchangeability is not practical, are parts of units designed for functional interchangeability, and are adapters provided to allow physical interchangeability, wherever practical?

## REFERENCES

1. DoD Directive No. 4120.3, *Defense Standardization and Specification Program*, 10 February 1979.
2. DoD Instruction No. 4120.19, *Department of Defense Parts Control Program*, 27 June 1984.
3. DoD Directive No. 4120.18, *Use of Metric System of Measurement*, 10 December 1976.
4. DARCOM-P 706-470, *Engineering Design Handbook, Metric Conversion Guide*, 5 July 1976.
5. DoD Directive No 2010.6, *Standardization and Interoperability of Weapons Systems and Equipment Within the North Atlantic Treaty Organization (NATO)*, 11 March 1977.
6. James R. Garver, "The Federal Catalog System". *Army Logistical* 16, 6 (November-December 1984).
7. Philip M. Morse, *Queues, Inventories and Maintenance*, John Wiley and Sons, Inc., New York, NY, 1958.
8. J. Philip Geddes, "Hughes Helicopters AH-64 in Advanced Development", *Interavia* (August 1978).
9. Col. George T. Petersen, "Design for Readiness". *Ordnance* (September-October 1967).
10. Robert G. D. Steel and James H. Torrie, *Principles and Procedures of Statistics*, McGraw-Hill Book Company, New York, NY, 1980, p. 106.
11. AR 700-60, *Department of Defense Parts Control Program*, 5 October 1977.
12. MIL-STD-962A, *Outline of Forms and Instructions for the Preparation of Military standards and Military Handbooks*, 26 October 1984.
13. MIL-STD-965, *Parts Control Program*. 26 August 1983.
14. MIL-STD-143B, *Standards and Specifications, Order of Precedence for the Selection of*, 12 November 1969.
15. *DoD Index of Specifications and Standards (DODISS)*.
16. DoD Manual No. 4120.3-M, *Defense Standardization Manual*, August 1978.
17. Army Master Data File (AMDF).
18. CDA Pamphlet No. 18-1, *Code Reference Guide*.
19. *Cataloging Handbook H2-1, Federal Support Classification, Part 1, Groups and Classes*.
20. AR 708-1, *Cataloging and Supply Management Data*, 1 April 1981.
21. "National Stock Numbers Increase", *Army Logistician* 14, 4 (July-August 1982).
22. AR 750-43, *Test, Measurement, and Diagnostic Equipment*, 1 March 1984.
23. *US Army Test Program Sets Procedures Manual, AMCPM-TMDE-T*, Fort Monmouth, NJ, 31 January 1986.
24. DA Pam 700-12-1, *DA TMDE Preferred Items List (PIL)*.

**This page intentionally left blank.**

## CHAPTER 4 ACCESSIBILITY

*Accessibility, as a significant attribute of maintainability, is discussed in detail. Considerations affecting the accessibility for three types of maintenance—visual inspection, tools and test equipment, and physical repair and replacement—are presented. Access parameters of size, location, and type are addressed. Specific guidance to access components of major classes of materiel is given. A checklist for maintainability engineers is provided.*

### 4-1 INTRODUCTION

Accessibility is defined as a design feature that affects the ease of admission to an area for the performance of visual and manipulative maintenance. Thus accessibility relates to the hardware configuration, i.e., packaging. If an item can be reached quickly requiring the use of a few standard tools and only a few simple steps the item is accessible. However, if an item can be reached quickly but requires many tools, special tools, many or difficult operations to reach it, the item is really not accessible. Also the mere fact that a technician can “get at something” does not mean that he can maintain it. If an awkward body position must be assumed to reach the item, requiring the repairman to be a contortionist, the item is not considered accessible and maintainable because the repairman may not be able to exert the forces required to make the repair. Furthermore, the disassembly or removal of parts that interfere with easy access to a component requiring maintenance is highly undesirable especially if the maintenance action is required at the unit level—adequate space usually is not available for laying out parts as they are removed. This increases the possibility that the parts will become lost, damaged, or contaminated with dirt and mud, and that further malfunctions will be introduced into the system.

Inaccessibility also embodies psychological effects. Controls: checkpoints; inspection windows; and lubrication, pneumatic, and hydraulic replenishment points are designed into the equipment to keep it operating at peak performance. If it is difficult to access these features, the operator or repairman will postpone or neglect these operations in favor of more convenient tasks.

The maintainability engineer, in his desire to maximize accessibility, should be aware of at least two limiting conditions, i.e.,

1. *Level of Accessibility.* Accessibility should be available only to the throwaway and discard level. If the item is to be discarded at the unit level, the task is simple. However, if the replaced item is to be returned for repair at the intermediate level, accessibility poses additional considerations.

2. *Safety.* Accessibility must be consistent with the associated system safety plan required by MIL-STD-882 (Ref. 1). The purpose of the safety plan is to minimize or eliminate hazards to which the operator or maintenance personnel will be exposed. The safety plan also addresses hazards to the system which may be introduced by maintenance actions. Maintainability design must interface with ground operations, weapon loading, on-loading of munitions, refueling, and mission function. For reasons of safety, maintenance personnel from a psychological point of view—would rather avoid working in areas exposed to live ordnance and easily ignited gaseous vapors. Also requirements for exposing the technician to potential hazards—moving parts, hot components, build-up of electric charge—should be avoided or minimized. Improved safety associated with maintenance operations will reduce maintenance time and, consequently, increase availability.

The variability in the physical size of personnel is directly related to accessibility. What is within easy reach of a 6.5-ft individual may be out of reach for a shorter person. Conversely, the larger individual may experience difficulty placing his larger hands around a component, particularly if he is wearing arctic mittens. Whether of large or small stature, maintenance personnel must have access to parts and room enough to operate on the parts—test, adjust, or replace. Accordingly, the qualitative aspects of human physiology and psychology as they affect access times will be addressed. The material in this chapter is closely related to Chapter 9, “Human Factors”, which presents quantitative aspects of anthropometric measures, visibility measures, and frequency of measurement errors. A mutual relationship exists between the maintainability engineer and the human factors engineer:

1. The maintainability engineer is responsible for quantifying inherent downtime and inherent availability.

2. The human factors engineer provides the quantitative information the maintainability engineer needs to insure that personnel who fall within the 5th and 95th percentiles can function within the access design.

The final design is a result of cost-effective trade-offs

## DOD-HDBK-791(AM)

among these and other disciplines.

The current "remove-and-replace" philosophy is the preferred policy; it displaces the "repair-in-place" policy for restoring materiel to a serviceable condition in the combat zone (Ref. 2). Thus accessibility is essentially synonymous with maintainability where remove-and-replace operations are involved. The sum of many "small" times saved due to a simple feature such as accessibility adds up to large reductions in maintenance time and effort, and thus increases availability.

In summary, in planning for accessibility, the items that will require the most frequent work must be examined to determine the type of maintenance each will require. Items that have high failure rates or require frequent service should be given preferential positioning for access. For example, a control assembly might consist of a power supply module and a control module. If the power supply is expected to fail more often than the control module and both modules are to have a common access, the power supply should be closer to the access. However, if the control module requires frequent adjustment to keep its performance up to par, then it should be allotted the preferred access position. Next, types of access, covers, methods of mounting, and required dimensions are determined. Once the types of access have been selected, the designer—working in conjunction with the maintainability engineer—must make certain that each access is large enough either for physical access or the employment of service or test equipment. This strategy is presented in the paragraphs that follow.

### 4-2 FACTORS AFFECTING ACCESSIBILITY

Considerations of accessibility are influenced by, and in turn exert influence on, virtually all other maintainability factors; thus its unique importance. Gaining access to components is second in importance only to fault isolation as a time-consuming maintenance activity; if automatic fault-isolation is embedded in the equipment, access unquestionably will rank first.

Accessibility requirements are determined by the maintenance action required which may be visual or physical, or both, depending on whether the task is inspecting, servicing, adjusting, repairing, or replacing. Generally, the requirements represent two needs, namely,

1. Placement of items requiring frequent maintenance attention where they can be easily seen and reached. Visibility is mandatory where a potential hazard exists.

2. Design of openings to permit access to components and to provide space in which to perform maintenance operations.

Guidelines for meeting these requirements are

1. Locate assemblies and parts so that structural units and other parts do not block access to them.

2. Place assemblies and parts so that sufficient room is available for the use of test probes and other needed tools.

3. Place all throwaway items so that they can be removed without the necessity of removing other items.

4. Design each assembly so that it need not be removed to troubleshoot any of its components.

5. Use plug-in modules wherever possible.

6. Design major units and assemblies—particularly engines and turbines—with removable housings so that they can be inspected completely.

### 4-3 MAINTENANCE ACCESS

Three general types of maintenance actions require access, namely.

1. Inspection—either sight or touch

2. Testing

3. Part adjustment, repair, or replacement.

To perform these maintenance actions, a means of access is required either merely to observe or to "lay one's hands on the unit". To determine the type, size, shape, and location of the access opening, it is necessary to have a thorough understanding of (Ref. 3)

1. operational location, setting, and location of the unit within the environment

2. Frequency of using the access

3. Maintenance tasks performed through the access

4. Time required to perform maintenance functions

5. Types of tools and accessories required

6. Work clearances required

7. Types of clothing operator and technician are likely to wear

8. How far into the access the operator or technician must reach

9. Visual requirements of task

10. Mounting of items, units, and elements behind access

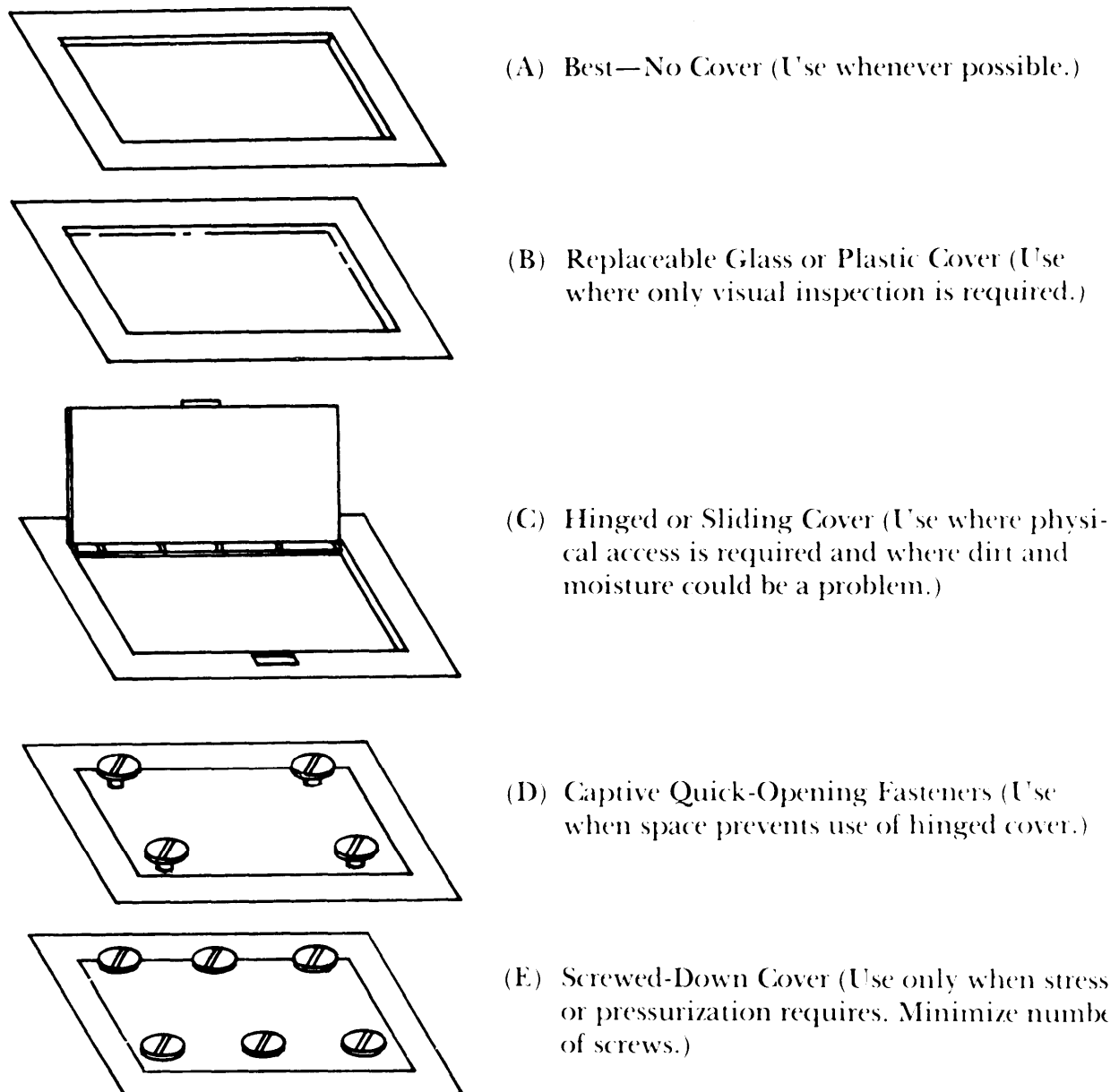
11. Hazards in using access

12. Size, shape, weight, and clearance requirements

for logical combinations of human appendages, tools, units, etc., that must enter the access.

Inspection primarily is performed by sight or touch. For example, a sight gage can be used to assure proper fluid levels. Inspections that require feeling for leaks are tactile and require physical rather than visual access. When inspection or testing locates a failed part, the access must be large enough to permit component repair or replacement.

Table 4-1 provides criteria for decisions relative to the types of accesses for the three maintenance actions. In the application of this table, inspection that requires touch rather than sight appears in the "For Physical Access" column. The recommendations related to accesses and covers are illustrated by Fig. 4-1 (Ref. 3). A general discussion of accesses for the three types of maintenance



**Figure 4-1. Types of Covers and Accesses (Ref. 3)**

actions is presented in pars. 4-3.1, 4-3.2, and 4-3.3. The parameters of access type, size, shape, and location applying the given list of considerations—are discussed in detail in pars. 4-4 and 4-5.

#### **4-3.1 ACCESS FOR VISUAL INSPECTION ONLY**

Visual access should be unblocked unless exposure is likely to degrade equipment or system performance. A clear, plastic window can be used if dirt, moisture, or other foreign materials present a problem. If physical

wear or the action of solvents and the environment are likely to reduce the transparency of the plastic cover, a break-resistant glass window should be used. If glass will not meet the stress or other requirements, then a quick-opening, metal cover should be used. Fig. 4-1 illustrates various cover types.

Visual inspection usually requires a light intensity of 55  $1\text{m}^2(\text{lux})$  or greater. Brightness contrast between the target object and its background must be considered as well as glare from both the work and light source. If an external light source is used, the transparency of the

**TABLE 4-1. RECOMMENDED EQUIPMENT ACCESSES**

DESIRABILITY	FOR PHYSICAL ACCESS	FOR VISUAL INSPECTION ONLY	FOR TEST AND SERVICE EQUIPMENT
Most desirable	Pullout shelves or drawers	opening with no cover	Opening with no cover
Desirable	Hinged door (if dirt, moisture, or other foreign materials must be kept out)	Scratch-resistant plastic window (if dirt, moisture, or other foreign materials must be kept out)	Spring-loaded sliding cap (it dirt, moisture, or other foreign materials must be kept out)
Less desirable	Removable panel with captive, quick-opening fasteners (if there is not enough room for hinged door)	Break-resistant glass (if plastic will not stand up under physical wear or contact with solvents)	Removable panel with captive, quick-opening fasteners (if there is not enough room for hinged door)
Least desirable	Removable panel with smallest number of largest screws that will meet requirements (if needed for stress, pressure, or safety reasons)	Cover plate with smallest number of largest screws that will meet requirements (if needed for stress, pressure, or safety reasons)	Cover plate with smallest number of largest screws that will meet requirements (if needed for stress, pressure, or safety reasons)

window should allow the required amount of light to be transmitted. When accesses are near components that are hazardous, and if the inspection requires access, the access door should be designed to turn on an internal light automatically when opened. Also, a highly visible warning label identifying the hazard should be posted on the access door.

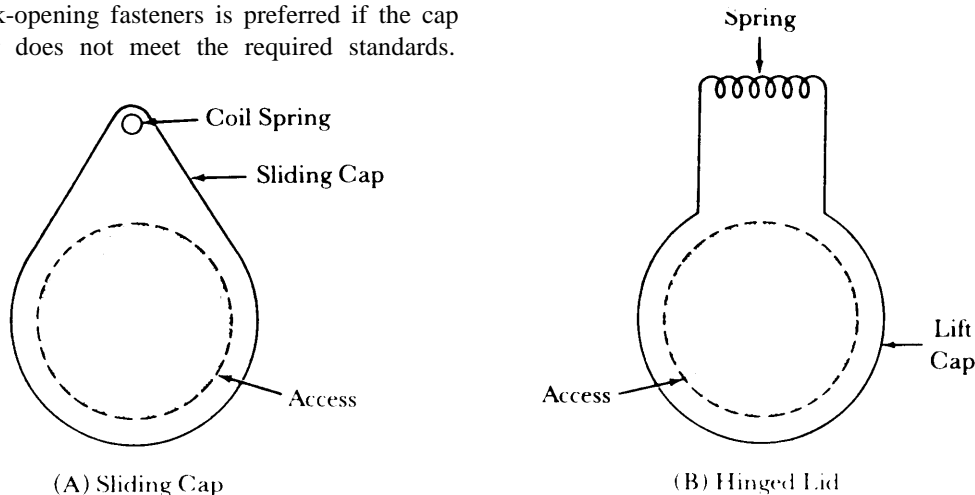
**4-3.2 ACCESS FOR TOOLS AND TEST EQUIPMENT**

Openings for tools and test equipment should be uncovered whenever feasible. Where dirt, moisture, or other foreign matter present a problem, a spring-loaded sliding cap or hinged door can be used (Fig. 4-2). Small sliding caps are particularly useful for small accesses that do not require a tight seal. Spring-loaded caps or lids should have a built-in catch to keep the catch or lid open. A cover plate with quick-opening fasteners is preferred if the cap or hinged door does not meet the required standards.

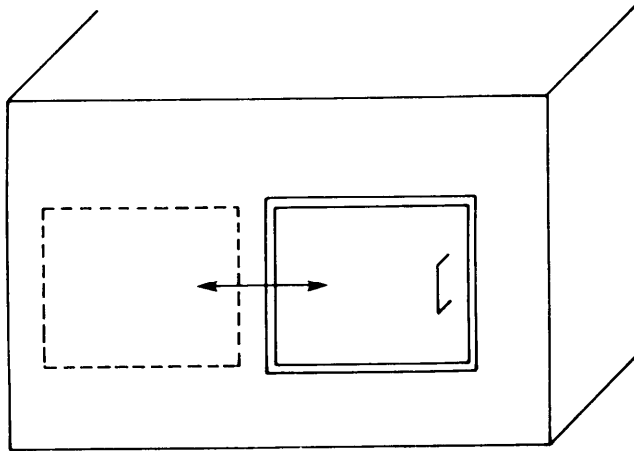
Large sliding doors may create structural problems, but they are particularly useful where door-swing space is limited. If the door is unusually large or heavy, handles should be provided to improve leverage (Fig. 4-3). Access doors and caps should be designed so that they

1. Lock positively
2. Do not jam or bind
3. Are easy to use and require no tools for operation
4. Do not interfere with, cause damage to, or present potentially harmful contact with electric wires, moving parts, or other items of equipment
5. Are visible enough so that they are not inadvertently left open.

To improve accessibility, the openings should provide for the use of roll-out, rotatable, and slide-out drawers, shelves, and racks or other hinged or sliding assemblies (Fig. 4-4) to



**Figure 4-2. Examples of Spring Loaded Sliding and Hinged Access Doors**

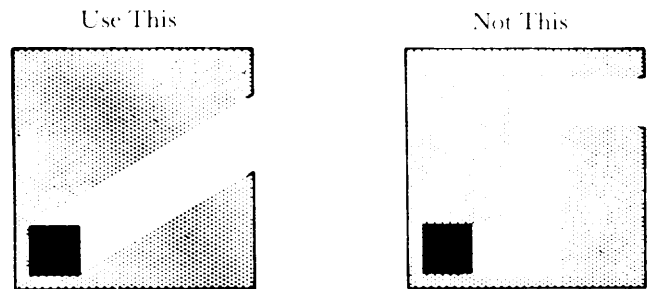


**Figure 4-3. Sliding Access Door With Handle**

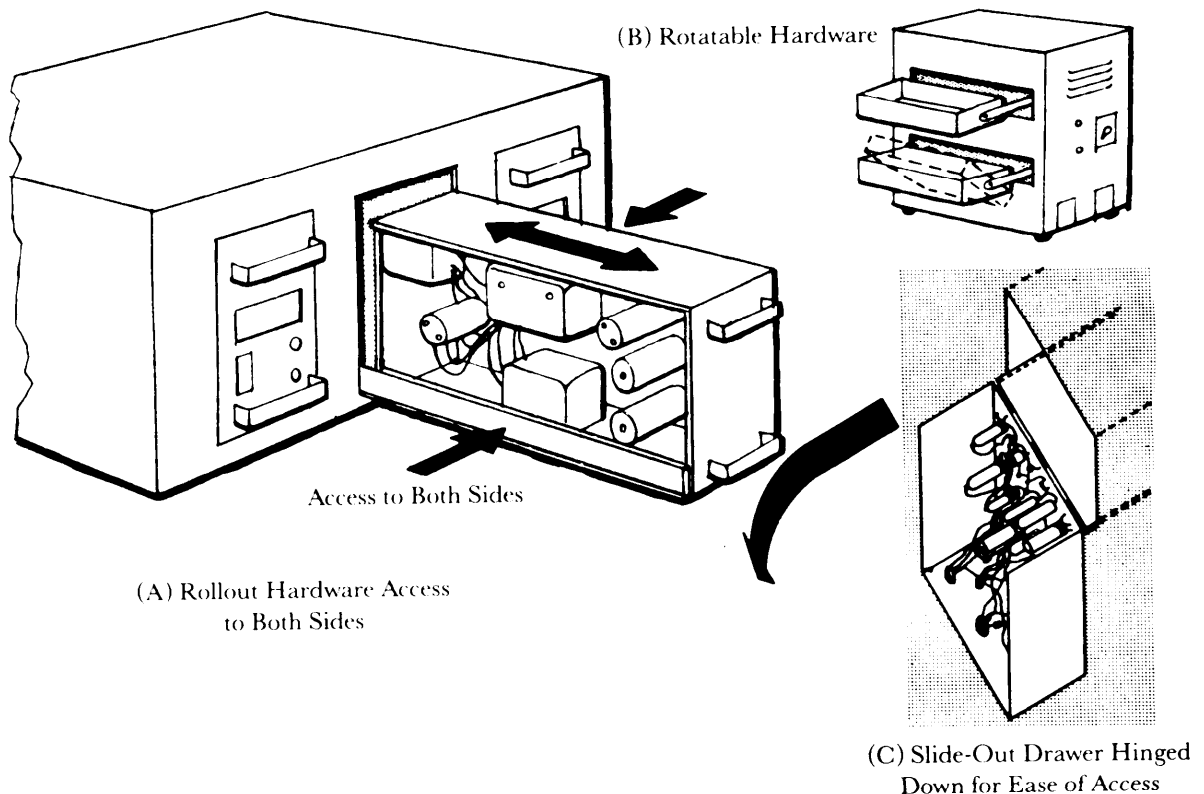
1. Optimize work space and tool clearance
2. Reduce the need for the operator or technician to handle fragile or sensitive items
3. Facilitate the handling and or positioning of heavy or awkward items
4. Facilitate access to items that must frequently be moved from the installed position for checking, servicing, or repairing.

**4-3.3 OPENINGS FOR PHYSICAL ACCESS**

Accesses should be sized and shaped to permit easy passage of components; this feature is closely related to the arrangement of components within the volume that the access is to accommodate (Fig. 4-5) (Ref. 3). If situations and environmental factors—dirt, danger from falling objects, climate—preclude an uncovered opening, a hinged door or sliding cover can be used (Figs. 4-1 and 4-3); a hinged door is preferred to a cover plate. The hinge should be supported at the bottom to remain open without manual effort. If this is not feasible, then a catch or bracket—preferably automatic—should be used. Under no circumstances should it be necessary to hold a door open manually (Fig. 4-6) (Ref. 3).



**Figure 4-5. Example of Access to Permit Easy Removal of Component (Ref. 3)**



**Figure 4-4. Examples of Rollout, Rotatable, and Slide-Out Drawers (Ref. 3)**

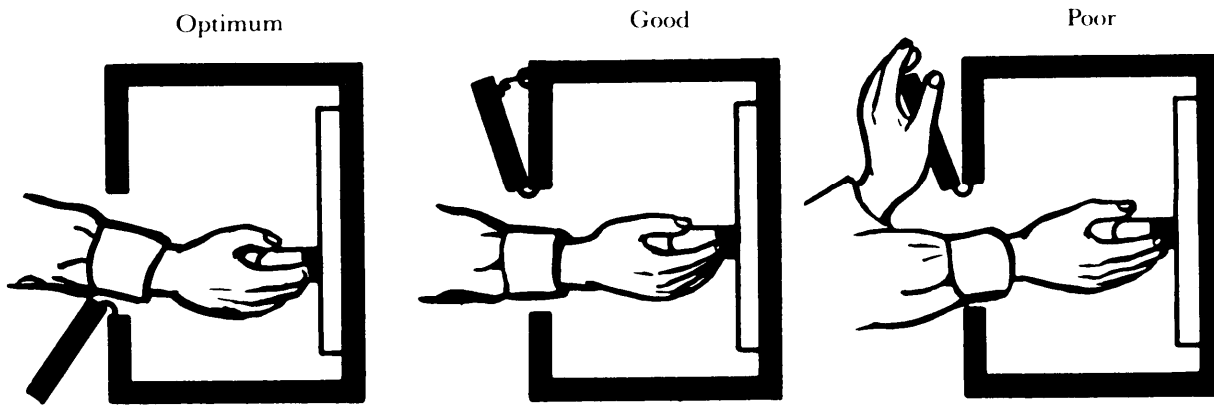


Figure 4-6. Methods of Securing Hinged Covers

#### 4-4 LOCATION OF ACCESSES

It is important to consider tactical scenarios when locating components and the access to these components. For example, the loading of ordnance and other mission-essential consumables must be rapid, and the readiness of mission-essential components must be checked before going into action. Accordingly, access for these essential operations must be accorded first priority; however, these same accesses can often accommodate maintenance operations. Also, existence of an access door through which to approach an item that may require maintenance is a necessary, but not sufficient, condition to assure ease of maintainability—the arrangement of the components behind the opening also is an important consideration (see par. 4-4.1). Thus a mutual relationship exists between the access and the positioning of the components to be accessed.

Where possible, accesses should be located

1. Only on equipment faces that are accessible as normally installed
2. For direct access and maximum convenience for job procedures, i.e., arrangement
3. On the same face of the equipment as related displays, controls, test points, cables, etc.
4. Away from high voltages or dangerous moving parts. If this is impossible, provide adequate insulation, shielding, barriers, etc., around such parts so personnel will not be injured. These factors should be considered in the system safety plan (Ref. 2).
5. To enable heavy items to be pulled out rather than lifted out
6. To accommodate items requiring frequent adjustment or maintenance
7. So that components behind the access will not be exposed to dripping oil or other fluids, or other contaminants generated by the equipment
8. To avoid frames, bulkheads, brackets, and structural members which will interfere with maintenance and operations personnel's reaching components which they

must maintain, inspect, or operate (Fig. 4-7) (Ref. 3). These general principles are expanded upon in the discussion that follows.

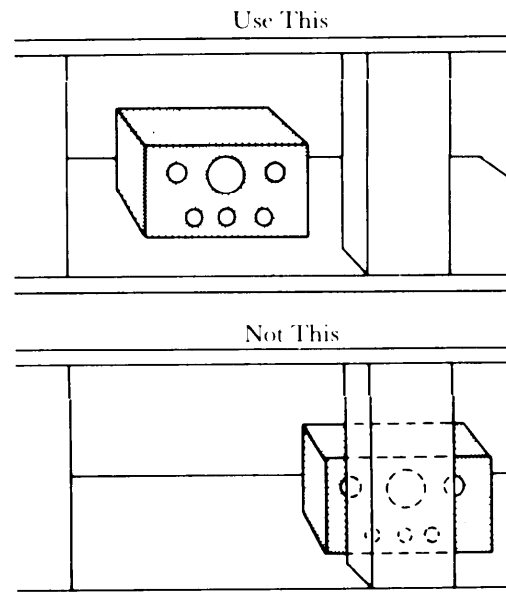
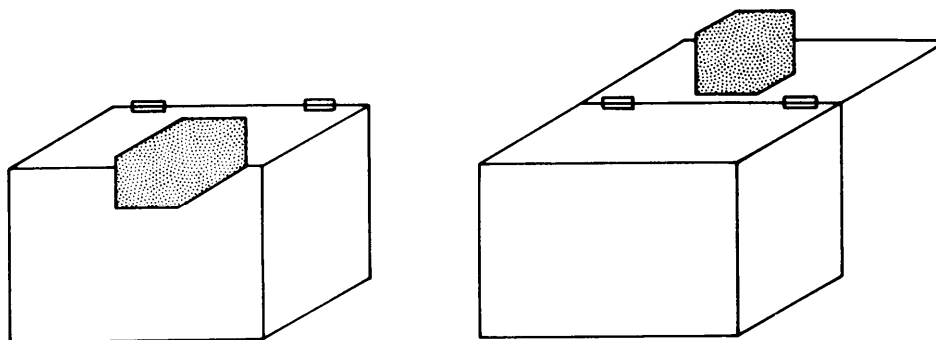


Figure 4-7. Avoidance of Structural Members (Ref. 3)

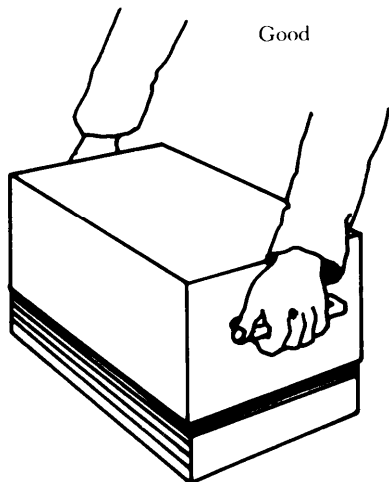
##### 4-4.1 COMPONENT ARRANGEMENT

The relative position of units which can be expected to require maintenance inside a box-like enclosure affects the amount of time required to perform the maintenance task. Consider the four possible mounting positions --i.e., top, bottom, side, or back panel:

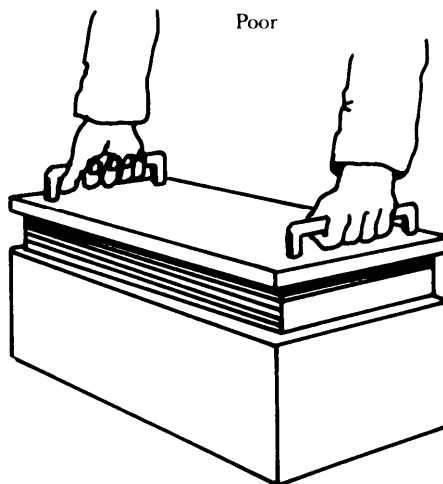
1. *Top Panel.* In this position, quick access requires that the panel
  - a. Be hinged in back
  - b. Have sufficient space above the box to swing the panel open and to manipulate the item after opening the box (Fig. 4-8 (A)) (Ref. 3).



(A) Top Position

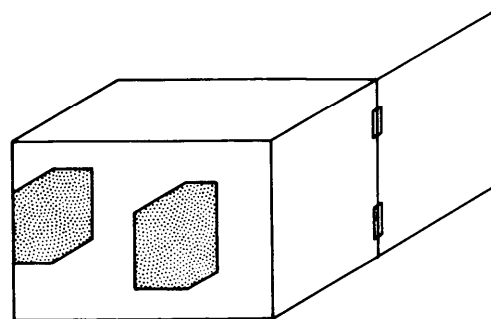
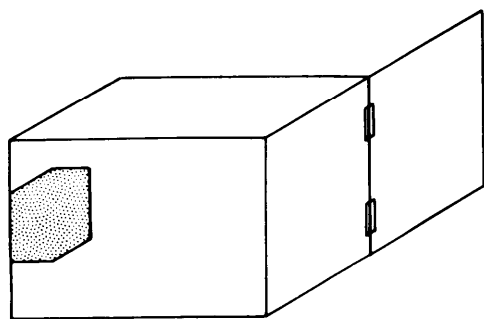


Good

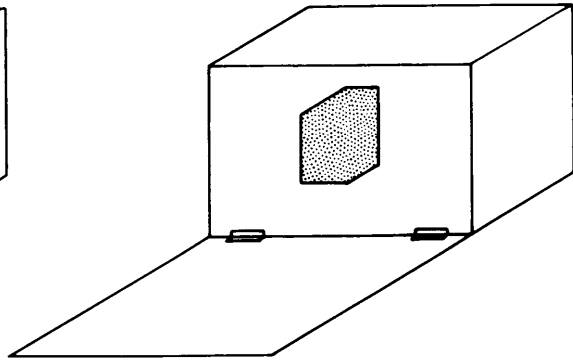
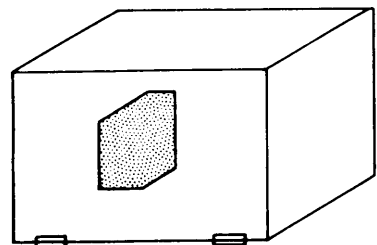


Poor

(B) Bottom Position



(C) Side Position



### 4-8. Component Mounting Positions

2. *Bottom Panel.* In this position, it is necessary to remove the box to expose the item. To minimize possible damage to the item within the box (Fig. 4-8( B)) (Ref. 3).

a. The box should be lifted off the item, and enough clearance should exist around the item to prevent damage and avoid requiring extremely fine or careful positioning or handling.

b. Handles should be provided if the box is heavy.

3. *Side Panel.* In this position, there must be space within the box for manipulative tasks (Fig. 4-8(C)) ( Ref. 3).

4. *Back Panel.* In this position, the panel facing the operator or technician is hinged on the bottom, and the item is mounted on the back panel (Fig. 4-8(D)) (Ref. 3). In many cases this is the most compact and accessible arrangement.

Components should be arranged with the following considerations in mind:

1. Sufficient space should be provided to use screwdrivers, test probes, soldering irons, wrenches, socket sets, and other required tools (Fig. 4-9). Access should be such that straight screwdrivers or adjustment tools, rather than offset tools, can be used.

2. High-failure rate components and all assemblies or parts that will require servicing or replacement should be accessible without removal of other items.

3. Plug-in items should be oriented in one direction to facilitate replacement. Fig. 4-10 illustrates this feature for vacuum tubes; however, it applies to other components as well.

4. Resistors, capacitors, and wiring should not interfere with plug-in part replacements. This consideration applies to nonelectrical systems as well.

5. Delicate components should be located where they will not be damaged while the unit is being repaired.

6. Fuses should be located so that they can be seen and replaced without removing other parts or sub-assemblies.

7. Tools should not be required for replacing fuses, filters, etc. Access to the fuses, filters, etc., should be with a minimum of time and tools.

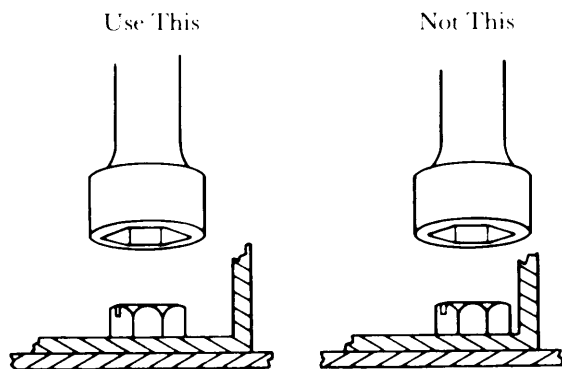


Figure 4-9. Clearance for Nuts and Bolts

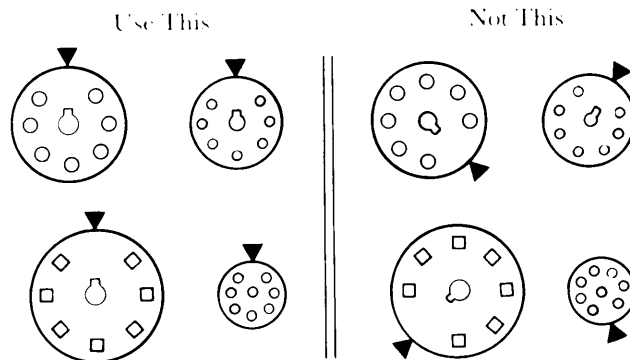


Figure 4-10. Common Orientation of Tube Sockets to Facilitate Tube Replacement

8. Internal controls such as switches and adjustment screws should not be located close to dangerous voltages or moving parts. Also minimize the likelihood of inadvertently jarring a switch or adjustment screw.

9. Components that retain heat or electrical charge after the equipment is turned off should be equipped with bleeder networks or should not be located where operators or technicians are likely to touch them while performing maintenance tasks.

10. Orient components such that, for example, a slipped screwdriver will not puncture a high-pressure hydraulic line.

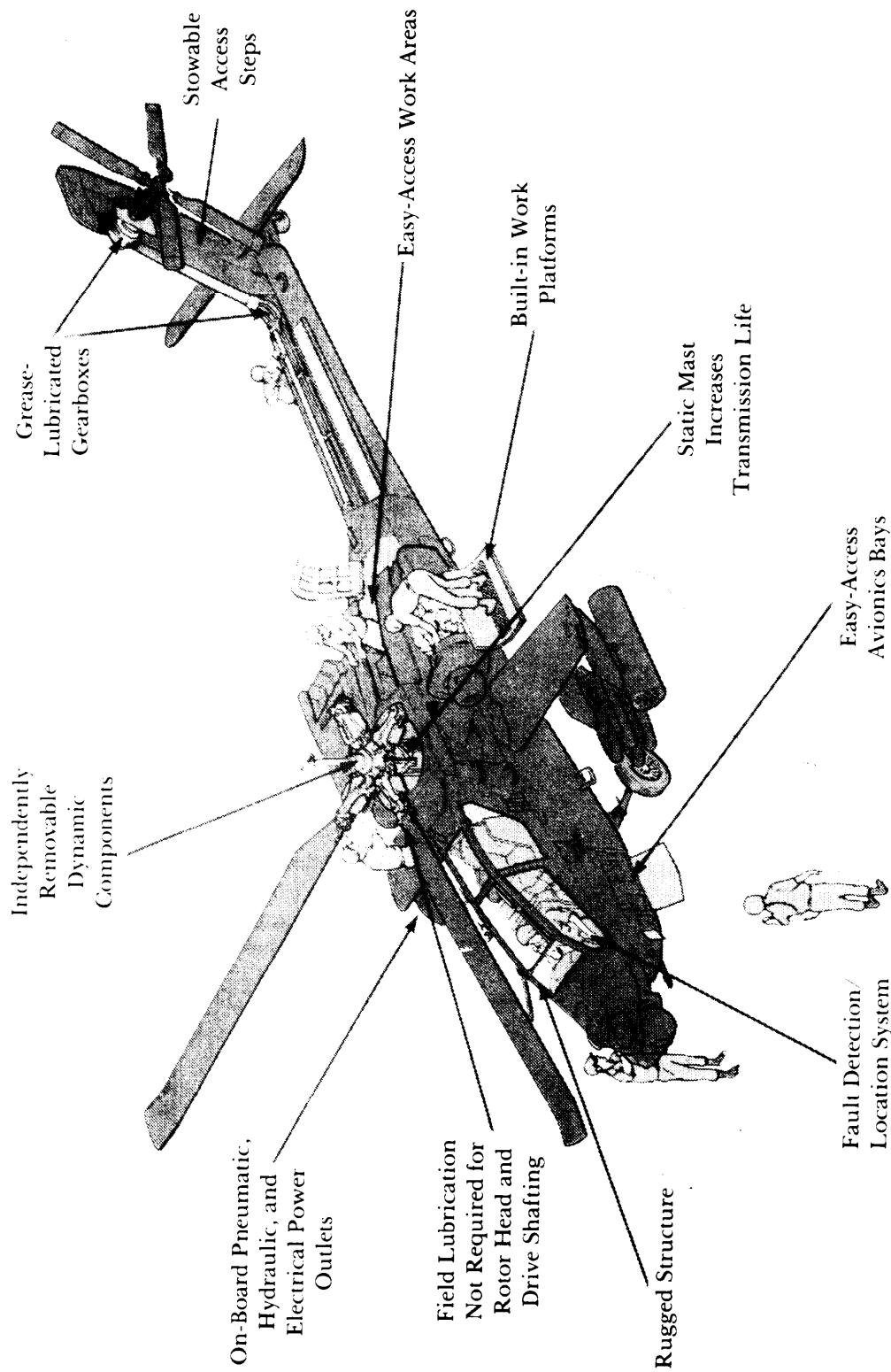
11. Do not stack units. If stacking is required to conserve space, place the unit requiring the least frequent access in the back or on the bottom.

12. Group together components that will be maintained by the same technician. They should be arranged to minimize movement from one position to another during system checking.

#### 4-4.2 COMPONENT DISPERSAL

Dispersion of components that are expected to require frequent maintenance can permit various elements of the equipment to be serviced simultaneously and thus improve equipment availability. However, this multiaccessible feature requires that the maintainability engineer investigate the manning studies performed because it would be ridiculous, for example, to provide five access parts for this purpose if the Table of Organization and Equipment authorized only one repairman.

Fig. 4-11 illustrates simultaneous maintenance operations on a modern helicopter. Seven repairmen are servicing the aircraft at different work stations. Multiple maintenance actions are the rule rather than the exception on some Army weapon systems. Under these conditions, downtime is not the sum of the individual maintenance times; rather, it is the longest of the parallel action times, assuming that operations at one station are not dependent on a signal or function from an adjoining work station.



**Figure 4-11. Simultaneous Maintenance Actions on a Modern Helicopter**

**4-5 SIZE OF ACCESS**

Generally, one large access is better than two or more small ones; however, access openings must be sized for the equipment that will be maintained and for the actions that will be performed. This requires considerations of sight, type of tool required, light intensity, and required maintenance operations within the access—i.e., the maintainability engineer determines what the operator or technician will have to see and do before deciding on the access size. In some instances a small hole that admits a screwdriver or grease gun is sufficient access. In other instances the technician may have to get a hand or, perhaps, his whole body into a piece of equipment. Also, the frequency with which the maintenance must be performed is a contributing factor. Fig. 4-12 indicates that 70% of the maintenance actions on electronic equipment are accomplished by the use of a screwdriver, pliers, wrench, and soldering iron. Obviously, the access opening for this equipment should be large enough to permit the entrance and manipulation of these tools.

Access size is also a function of the movements turning, pulling, pushing, twisting—of the human body part or parts once access is gained and a function of the dimensions of the body part or parts that must be admitted through the opening. These two factors are determined by dynamic and static body measurements. Human factors analyses also consider anthropometric sizing in system functions. (See Chapter 9, “Human Factors”.) The fact that the operator or technician maybe wearing arctic clothing while performing a maintenance action will also influence access size. Table 4-2 and Figs. 4-13, 4-14, and 4-15 provide anthropometric data relative to gaining access through ports of various sizes.

The size of access openings is also determined by the size and shape of parts, components, or assemblies to which access is desired. This is particularly true if the item must be removed and replaced through the openings. Access panels should be sized to avoid opening more than one panel to gain access to any single item behind the panel. The panel should be sized and components located—to permit units to be removed along a straight or slightly curved path rather than a less direct path (Fig. 4-5). This will facilitate removal and decrease the possibility of damage to fragile components during withdrawal.

**4-6 EXAMPLES**

Design for accessibility will be discussed for the following seven areas:

1. Electronics
2. Fire control
3. Missiles
4. Mobile equipment trailers
5. Tank-automotive materiel
6. Army marine equipment
7. Army aircraft.

**4-6.1 ELECTRONICS**

Electronic and electrical components should be located for easy access and removal and should be designed if not of the throwaway type for case of access of test equipment and/or tools required for repair at the intermediate or depot level. Other accessibility decisions are influenced by considerations of equipment protection, operator or technician protection, layouts, openings, interference, vision, and handle design.

Fig. 4-16 illustrates a foldout construction layout for an electronic chassis. This construction should be used for subassemblies whenever feasible. The parts and wiring should be positioned to prevent damage when opening or closing the assembly.

Braces or similar items should be provided to hold hinged assemblies in the “out” position while they are being maintained (Fig. 4-17); this arrangement leaves both hands free to perform required maintenance operations. Rests or stands should be provided to prevent damage to delicate parts. If feasible, these rests or stands should be part of the basic chassis as shown in Fig. 4-18. Side aligning devices, similar to the ones shown in Fig. 4-19, are desirable for heavy components because the component can be slid into place.

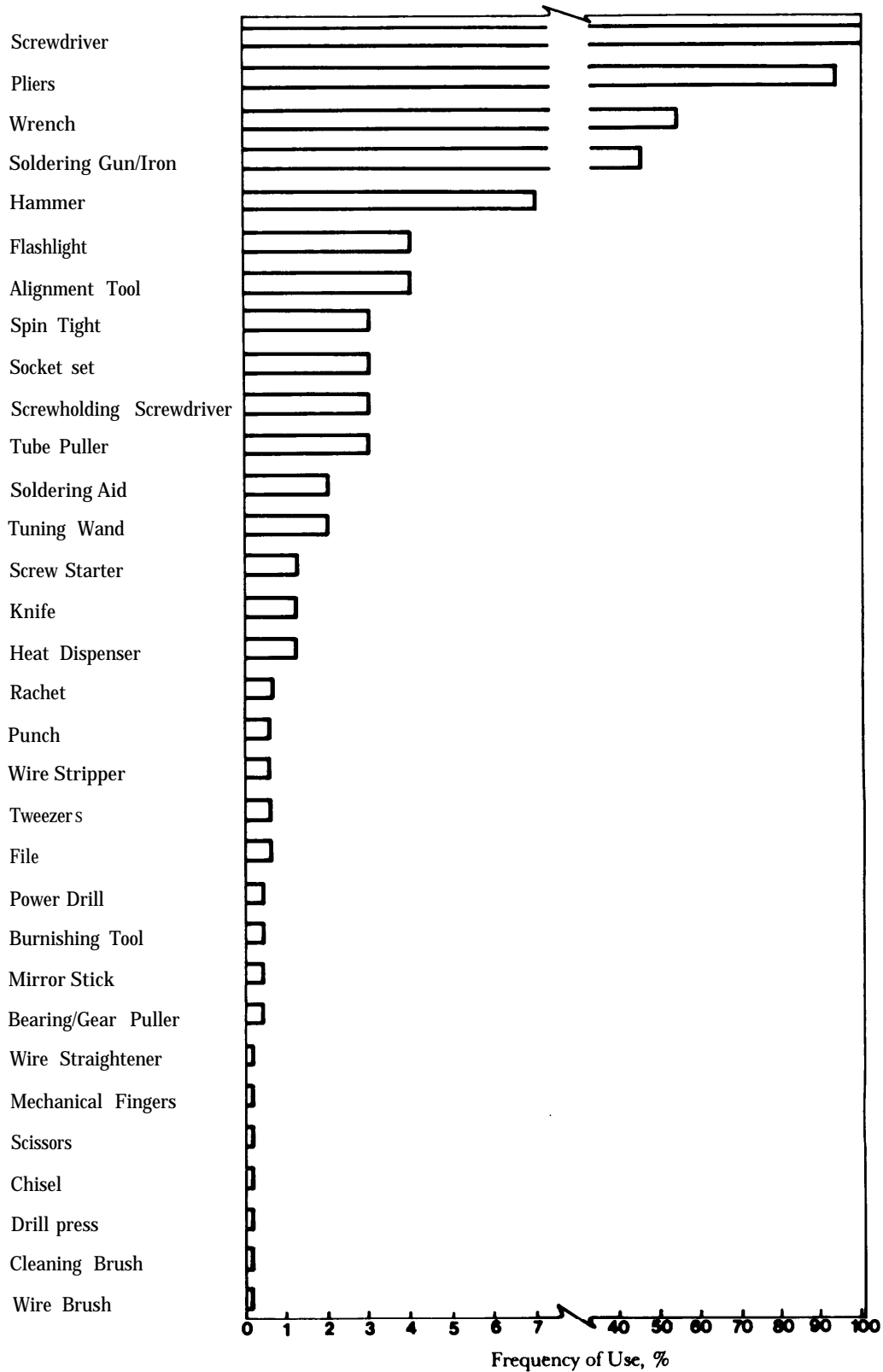
Some commonly used handles shown in Fig. 4-20 are finger recess, hand recess, T-bar, and J-bar. Minimum acceptable dimensions of these handles together with minimum curvature or edges when carrying various loads are also given. Handles should be provided on the covers of units and positioned for balance to facilitate removing the cover and carrying the item; the use of fingers (Fig. 4-21) or levers to pry off covers is not good practice. Covers of cases should be designed to be lifted off the unit; the unit should not have to be lifted out of its cover (Figs. 4-8(B) and 4-22). Handles can also serie various supplementary applications as shown in Fig. 4-23.

Whenever practical, wire connections should be made with U-type lugs rather than O-type lugs as shown in Fig. 4-24 to facilitate removal. Terminals for soldered wire should be far enough apart so that work on one terminal does not compromise the integrity of an adjacent terminal as shown in Fig. 4-25. The terminals should be long enough to prevent damage to insulation from the hot soldering iron as shown in Fig. 4-26.

Cables should be routed so they

1. Are not pinched by doors, lids, and slides
2. Are not walked on they should not be on the same side of the panel reserved for access or operations as shown in Fig. 4-27
3. Are accessible to the technician i.e., not under floorboards, behind panels or components that are difficult to remove, or routed through congested areas
4. Are not bent or unbent sharply, as shown in Fig. 4-28, when connected or disconnected.

Cable connections that are maintained between sta-



**Figure 4-12. Frequency With Which Hand Tools Are Used at Least Once in 427 Maintenance Tasks on Electronic Equipment**

**TABLE 4-2. APERTURE DIMENSIONS  
FOR REGULARLY CLOTHED  
TECHNICIAN**

Body Member or Position	Dimensions
Passing head breadth	178 mm (7 in.)
Passing shoulder width	508 mm (20 in.)
Passing body thickness	330 mm (13 in.)
Passing through access in a crawling position	788 mm (31 in.) high, 508 mm (20 in.) wide
Passing through access in kneeling position (with back erect)	1638 mm (65 in.) high, 508 mm (20 in.) wide
Two men passing through access abreast (standing)	914 mm (36 in.) wide

A. Arm to Elbow

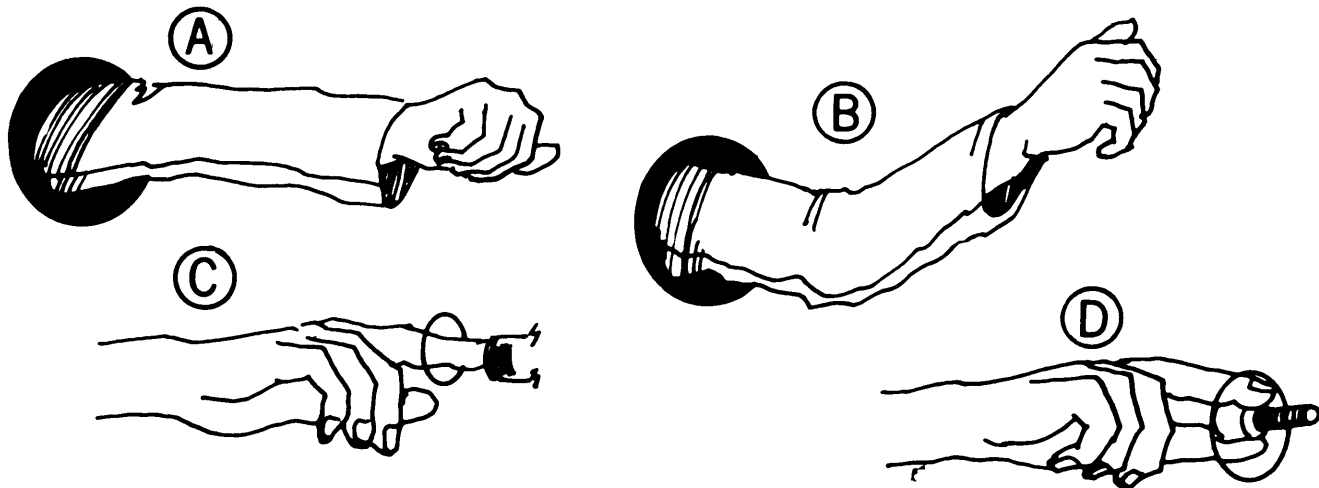
- Light clothing: 102 mm X 114 mm or 114 mm dia (4.0 in. X 4.5 in. or 4.5 in. dia)
- Arctic clothing: 178 mm (7.0 in.) square or dia
- With object: clearances as above

B. Arm to Shoulder

- Light clothing: 102 mm (4 in.) square or dia
- Arctic clothing: 216 mm (8.5 in.) square or dia
- With object: clearances as above

Minimal Finger-Access (First Joint)

- C. Operating Push Button
  - Bare Hand: 32 mm (1.25 in.) dia
  - Gloved Hand: 38 mm (1.5 in.) dia
- D. Twisting With Two Fingers
  - Bare Hand: 51 mm (2.0 in.) dia
  - Gloved Hand: 64 mm (2.5 in.) dia



**Figure 4-13. One-Hand Access Openings (Ref. 3)**

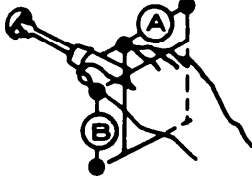
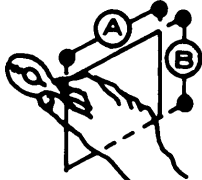
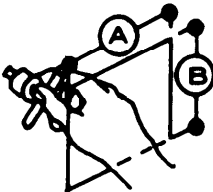
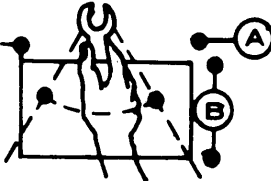

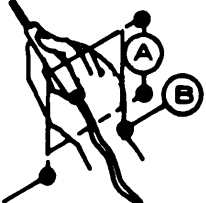
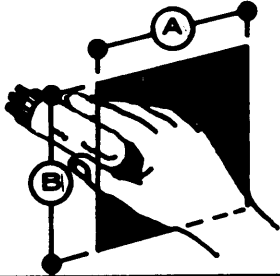
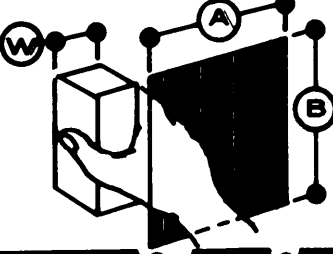
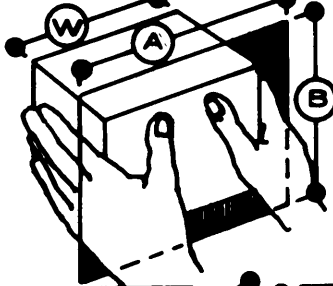
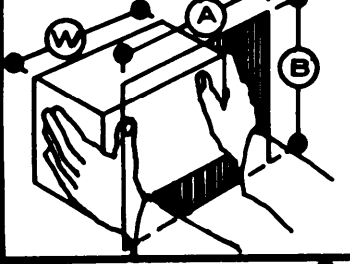
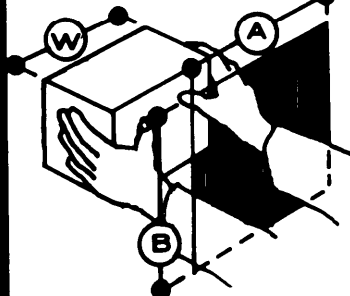
Opening Dimensions	Dimensions, mm (in.)		Task
	A	B	
	107 (4.2)	117 (4.6)	Using Common Screwdriver With Freedom to Turn Hand Through 180 Deg
	132 (5.2)	114 (4.5)	Using Pliers and Similar Tools
	135 (5.3)	155 (6.1)	Using "F" Handle Wrench With Freedom to Turn Hand Through 180 deg
	267 (10.6)	203 (8.0)	Using Open-End Wrench With Freedom to Turn Wrench Through 60 Deg
	122 (4.8)	155 (6.1)	Using Allen-Type Wrench With Freedom to Turn Wrench Through 60 Deg
	89 (3.5)	89 (3.5)	Using Test Probe, etc.

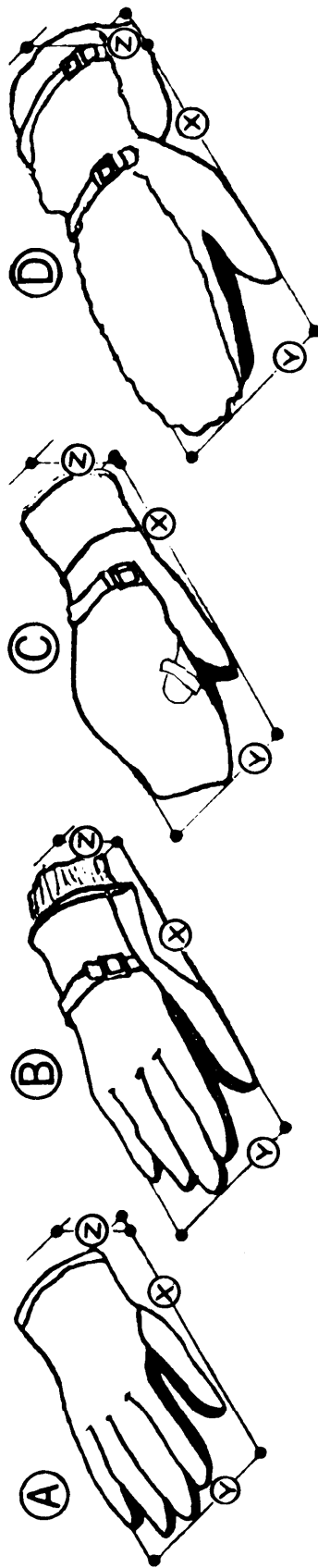
Figure 4-14. Access-Opening Dimensions (Ref. 3)

(cont'd on next page)

Opening Dimensions	Dimensions, mm (in.)		Task
	A	B	
	107 (4.2)	119 (4.7)	Grasping Small Objects Up to 52 mm or More Wide) With One Hand
	W + 45 (1.75)	127* (50)	Grasping Large Objects (52 mm or More Wide) With One Hand
	W + 76 (3.0)	127* (5.0)	Grasping Large Objects With Two Hands, With Hands Extended Through Openings Up to Fingers
	W + 152 (6.0)	127* (5.0)	Grasping Large Objects With Two Hands, With Arms Extended Through Openings Up to Wrists
	W + 152 (6.0)	127* (5.0)	Grasping Large Objects With Two Hands, With Arms Extended Through Openings Up to Elbows

\*Or sufficient to clear part if part is larger than 127 mm.

Figure 4-14 (cont'd)



Hand Position	A Anticontact Glove, mm (in.)			B Wet-Cold Glove, mm (in.)			C Wet-Cold Mitten, mm (in.)			D Arctic Mitten, mm (in.)		
	X	Y	Z	X	Y	Z	X	Y	Z	X	Y	Z
Extended Flat	267 (10.5)	119 (4.7)	64 (2.5)	272 (10.7)	145 (5.7)	76 (3.0)	361 (14.2)	152 (6.0)	81 (3.2)	422 (16.6)	137 (5.4)	91 (3.6)
Closed as Fist	178 (7.0)	127 (5.0)	84 (3.3)	185 (7.3)	147 (5.8)	94 (3.7)	292 (11.5)	147 (5.8)	97 (3.8)	363 (14.3)	132 (5.2)	137 (5.1)
Grasping Handle 6 mm (0.25 in.) dia	178 (7.0)	127 (5.0)	89 (3.5)	185 (7.3)	140 (5.5)	89 (3.5)	279 (11.0)	145 (5.7)	107 (4.2)	356 (14.0)	140 (5.5)	111 (4.5)
25 mm (1.0 in.) dia	178 (7.0)	127 (5.0)	89 (3.5)	185 (7.3)	135 (5.3)	102 (4.0)	279 (11.0)	132 (5.2)	114 (4.5)	356 (14.0)	132 (5.2)	111 (4.5)
50 mm (2.0 in.) dia	191 (7.5)	97 (3.8)	109 (4.3)	203 (8.0)	119 (4.7)	102 (4.0)	305 (12.0)	132 (5.2)	119 (4.7)	381 (15.0)	137 (5.4)	127 (5.0)
Grasping Knob 6 mm (0.25 in.) dia	203 (8.0)	97 (3.8)	109 (4.3)	229 (9.0)	117 (4.6)	102 (4.0)	292 (11.5)	127 (5.0)	107 (4.2)	394 (15.5)	122 (4.8)	114 (4.5)
25 mm (1.0 in.) dia	229 (9.0)	89 (3.5)	102 (4.0)	229 (9.0)	114 (4.5)	102 (4.0)	305 (12.0)	127 (5.0)	107 (4.2)	401 (15.8)	122 (4.8)	122 (4.8)
50 mm (2.0 in.) dia	241 (9.5)	94 (3.7)	94 (3.7)	234 (9.2)	114 (4.5)	107 (4.2)	318 (12.5)	117 (4.6)	112 (4.4)	406 (16.0)	119 (4.7)	122 (4.8)

Figure 4-15. Gloved-Hand Dimensions for 95th Percentile Man (Ref. 3)

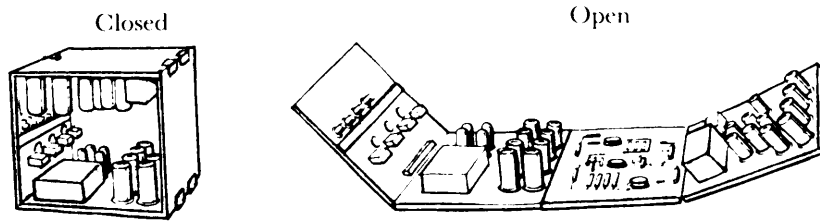


Figure 4-16. Foldout Construction for Electronic Chassis (Ref. 3)

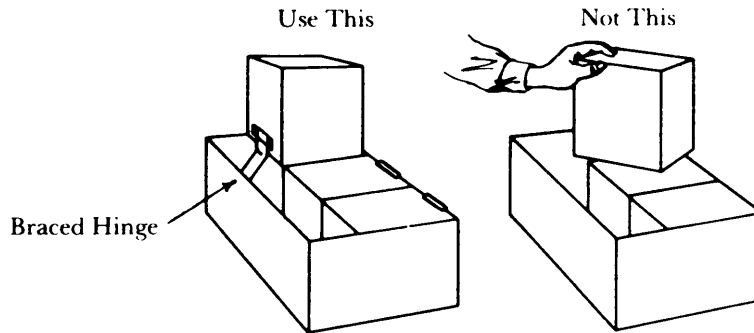


Figure 4-17. Hinged Assemblies Braced in "Out" Position Leave both Hands Free (Ref. 3)

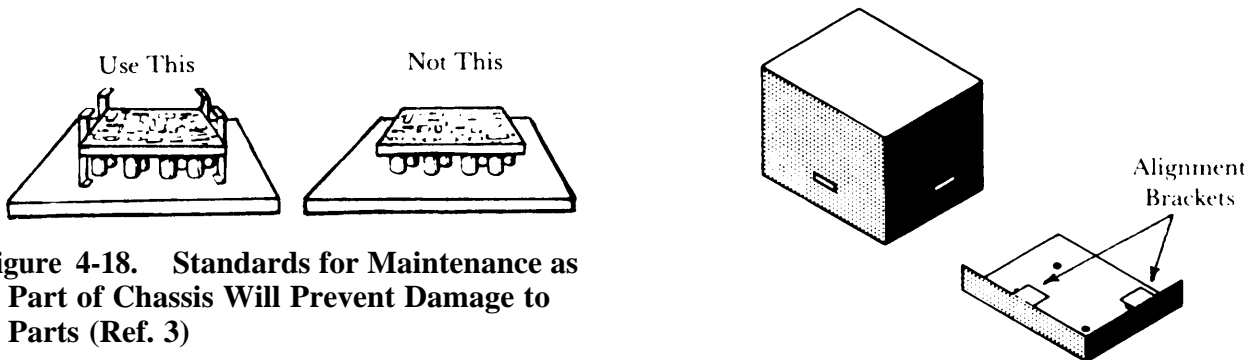
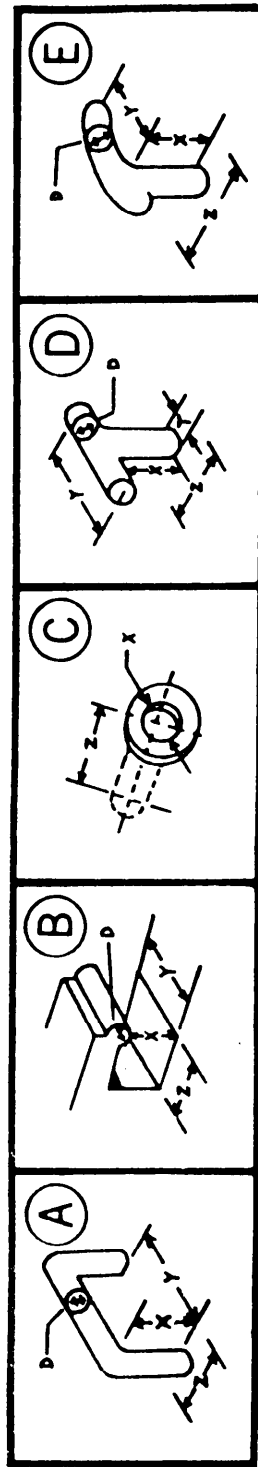


Figure 4-18. Standards for Maintenance as Part of Chassis Will Prevent Damage to Parts (Ref. 3)

Figure 4-19. Side-Alignment Brackets Facilitate Correct Mounting (Ref. 3)



Type of Handle:	Bare Hand, mm (in.)			Gloved Hand, mm (in.)			Mittened Hand, mm (in.)		
	X	Y	Z	X	Y	Z	X	Y	Z
A. Two-Finger Bar	32 (1.25)	61 (2.5)	76 (3.0)	38 (3.0)	76 (3.0)	76 (3.0)	89 (3.5)	133 (5.25)	not applicable
One-Hand Bar	50 (2.0)	114 (4.5)	76 (3.0)	89 (3.5)	133 (5.25)	102 (4.0)	89 (3.5)	279 (11.0)	152 (6.0)
Two-Hand Bar	50 (2.0)	216 (8.5)	76 (3.0)	89 (3.5)	267 (10.5)	102 (4.0)	89 (3.5)	279 (11.0)	152 (6.0)
B. Two-Finger Recess	32 (1.25)	61 (2.5)	50 (2.0)	38 (1.5)	76 (3.0)	50 (2.0)	not applicable	not applicable	not applicable
One-Hand Recess	50 (2.0)	108 (4.25)	89 (3.5)	89 (3.5)	133 (5.25)	102 (4.0)	89 (3.5)	133 (5.25)	127 (5.0)
C. Fingertip Recess	19 (0.75)	—	13 (0.5)	25 (1.0)	—	19 (0.75)	not applicable	not applicable	not applicable
One-Finger Recess	32 (1.25)	—	50 (2.0)	38 (1.5)	—	50 (2.0)	not applicable	not applicable	not applicable
D. T-Bar	38 (1.5)	102 (4.0)	76 (3.0)	50 (2.0)	114 (4.5)	102 (4.0)	not applicable	not applicable	not applicable
E. J-Bar	50 (2.0)	102 (4.0)	76 (3.0)	50 (2.0)	114 (4.5)	102 (4.0)	76 (3.0)	127 (5.0)	152 (6.0)

Curvature of Handle or Edge:

Weight of Item, N(lb)	Diameter (min), mm (in.)
up to 67 (15)	6 (0.25)
67 to 89 (15 to 20)	13 (0.50)
89 to 178 (20 to 40)	19 (0.75)
over 178 (40)	25 (1.00)
T-Bar Post	13 (0.50)

Gripping efficiency is best if finger can curl around handle or edge to any angle of 120 deg or more.

(For smaller (miniaturized) type components particularly, dimensions should conform as closely as practicable.)

Figure 4-20. Handle Dimensions

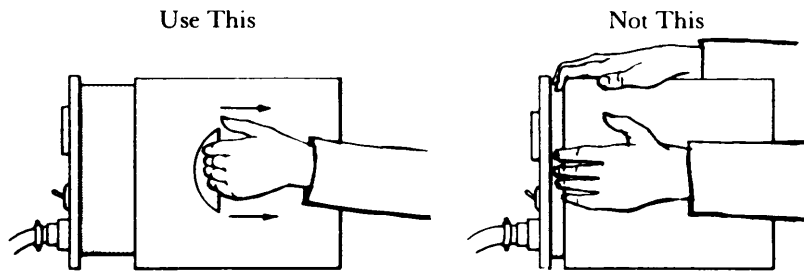


Figure 4-21. Handles Facilitate Removal of Covers and Carrying of Units

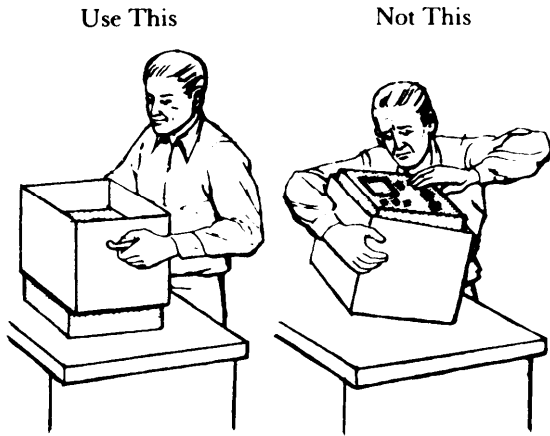


Figure 4-22. Cases Should Lift Off Units

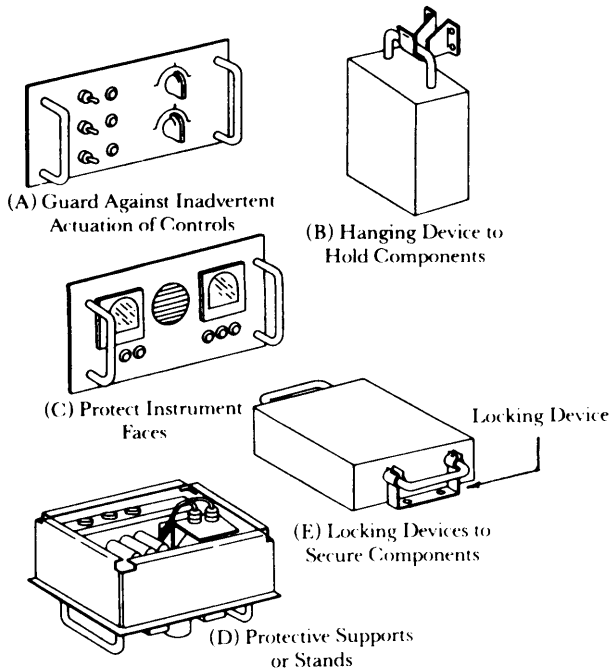


Figure 4-23. Additional Use of Handles

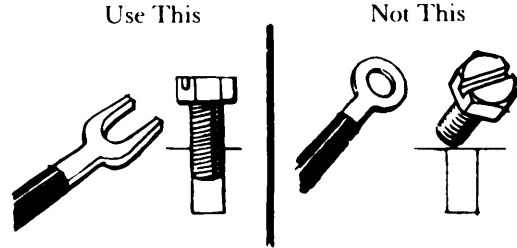


Figure 4-24. U-Type Lugs Facilitate Repairs

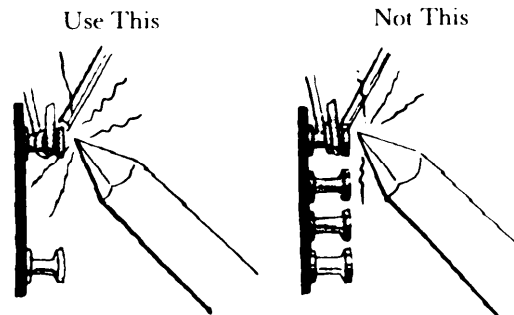


Figure 4-25. Spacing Wire Leads Facilitates Repairs

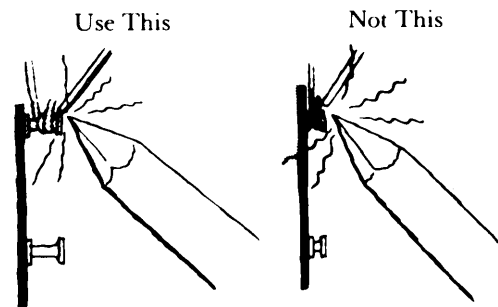
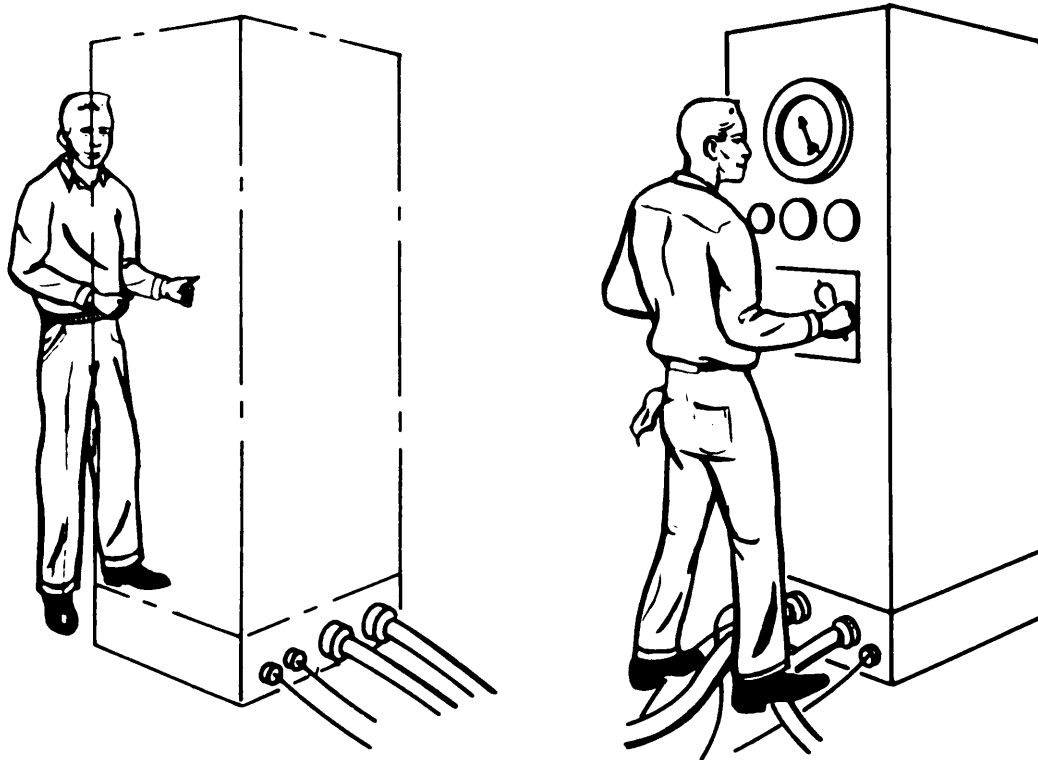
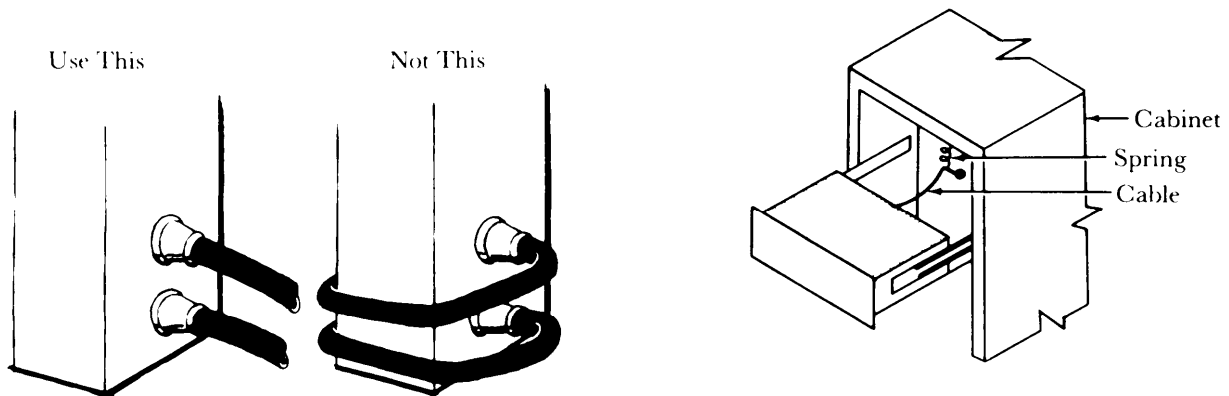


Figure 4-26. Terminals Should Be Long Enough to Prevent Damage to Insulation During Repairs



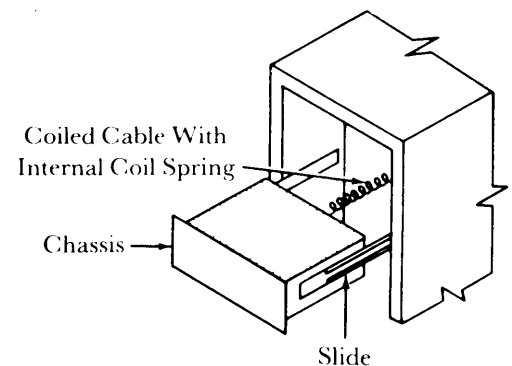
**Figure 4-27. Route Cables So They Are Not Likely to Be Walked On (Ref. 3)**



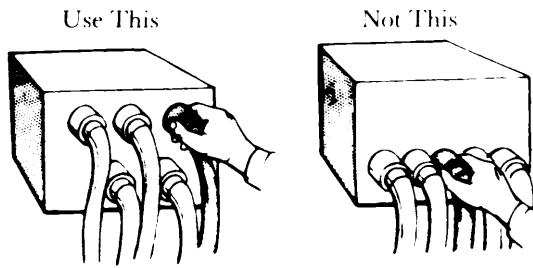
**Figure 4-28. Route Cabling to Avoid Sharp Bends (Ref. 3)**

tionary equipment and sliding chassis or hinged doors should have service loops to permit movement, such as pulling out a drawer for maintenance, without breaking the electrical connection. The service loops should contain a return feature to prevent interference when the removable chassis are returned to the cabinet. Fig. 4-29 shows two methods of recoiling the cable.

Cable connectors should be far enough apart to insure firm gripping for connecting and disconnecting (Fig. 4-30). The space required will depend on the size of the plugs plus a minimum separation of 64 mm (2.5 in.).



**Figure 4-29. Methods for Recoiling Service Loops in Sliding Chassis (Ref. 3)**



**Figure 4-30. Connectors Should be Arranged So That They Can Be Grasped Firmly for Disconnection**

#### 4-6.2 FIRE CONTROL EQUIPMENT

Fire control equipment – optical sights, laser range finders, laser designators, radars, infrared sources, and electronic computers—are usually readily accessible because they must be accessed to locate and track the target and to aim the weapon. Access to computer and radar components, being essentially electronic and electrical, is addressed in par. 4-6.1. Maintenance for optical sights and laser equipment, except for replacement of rubber eye pieces, is confined to the depot level; therefore, ready, ease of access is not a critical factor.

The fixtures that attach the optical sights to the weapon or laser range finders should be readily accessible and require no special tools to operate—quick disconnect type fasteners should be used wherever possible.

Laser and optical sight equipment require a clean room atmosphere and precise adjustments to achieve alignment of components and collimation—tasks too delicate to be performed at the unit or intermediate maintenance levels. Maintenance to be performed at the depot level does not relieve the designer of providing access to components or for operations that will facilitate maintenance, e.g.,

1. A means for purging and charging instruments should be provided and be easily accessible. The access should be located so as not to interfere with seals or expose lenses to abrasion.
2. Aligning, collimating, and triggering devices should be so located as to insure that the repairman cannot accidentally expose himself to the emerging laser beam.

#### 4-6.3 MISSILES

Missiles should be provided with suitable access doors or removable covers for servicing operations such as inspection, test, lubrication, drainage, adjustment, fuze setting, and replacement of parts. In particular, the adaptation kit—providing the safing, arming, and fuzing functions—must be readily accessible.

The access openings should be of sufficient size and proper shape to furnish an adequate view of the parts to be serviced. The access opening should be large enough to

permit entrance of a gloved hand whenever possible. (See Fig. 4-15 for gloved-hand dimensions.) The access doors should be externally flush e.g., retractable handles to preserve the aerodynamic shape of the missile—easy to open, and held securely closed by the appropriate fasteners. Fig. 4-31 shows examples of various types of fasteners and their actions. The doors should also be designed so that the action of the slipstream will tend to keep the doors closed in flight.

#### 4-6.4 MOBILE EQUIPMENT TRAILERS

The word “accessibility” has a different connotation from that previously used in this chapter. In this paragraph, accessibility does not relate to the maintenance of the trailers or mobile equipment; instead, accessibility relates to the design of the mobile equipment to make the materiel it services more accessible. The trailer chassis usually are constructed of commercial components and have been engineered for maintenance, and the required maintenance is minimal.

It could be argued that some of the presented guidelines are human factors features; however, this is too narrow an interpretation—where a mutual relationship appears to exist, a guideline is stated.

##### 4-6.4.1 Component Trailers

This discussion relates only to the manner in which the component trailer facilitates access to the materiel for which it was designed to service. Design guidelines or considerations follow:

1. Design component trailers with precise positioning controls in the  $x$ -,  $y$ -, and  $z$ - directions if precise positioning is necessary. Personnel should not be required manually to push or lift heavy components in order to mate them. If a primitive, common type of lifting device will do the job, do not provide a special materiel-specific item.
2. Design component trailers of sufficient height and configuration to enable the transported item to be directly in line with its component part. This feature is illustrated in Fig. 4-32 in which a warhead is being mounted on a missile.
3. Equip the trailer with brakes so that it can be immobilized for precise positioning with cradle controls after coarse positioning movements have been made by maneuvering the trailer. Locate the brake controls so that personnel can reach them while manually restraining the trailer.
4. Design trailers to allow for individually swiveling all four wheels to reduce positioning time.
5. Design independent controls such as roll, pitch, or yaw—for component trailers. These controls will allow the technician to position components properly for required maintenance if the trailer is to be used as a maintenance stand.

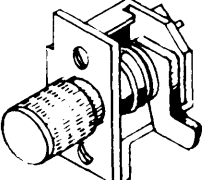
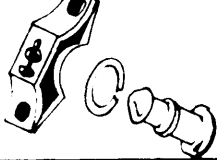
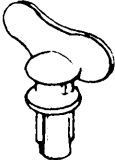

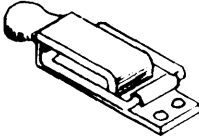
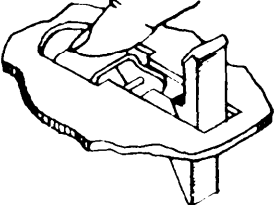
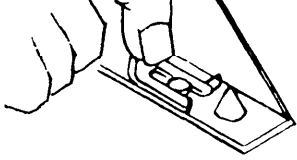
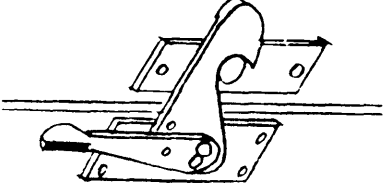
Type	Description
	<p>Adjustable Pawl Fastener</p> <p>As knob is tightened, the pawl moves along its shaft to pull back against the frame. 90 deg rotation locks, unlocks fastener.</p>
	<p>"Dzus"—Type Fastener With Screwdriver Slot</p> <p>Three-piece 1/4-turn fastener. Spring protects against vibration. 90 deg rotation locks, unlocks fastener.</p>
	<p>Wing Head, "Dzus" Type</p> <p>90 deg rotation locks, unlocks fastener.</p>
	<p>Captive Fastener With Knurled, Slotted Head</p> <p>Retaining washer holds the threaded screw captive.</p>
	<p>Draw-Hook Latch</p> <p>Two-piece, spring latch, base unit and striker. When engagement loop is hooked over striker, depressing lever closes unit against force of springs. Lever is raised to unhook.</p>
	<p>Trigger-Action Latch</p> <p>One-piece, bolt latch. Depressing trigger releases bolt, which swings 90 deg under spring action and opens latch. To close, move bolt back into position.</p>
	<p>Snapslide Latch</p> <p>One-piece snapslide. Latch is opened by pulling lever back with finger to engage release lever.</p>
	<p>Hook Latch</p> <p>Hook engages knob on striker plate. Handle is pulled up and locks in place. To release, reverse procedure.</p>

Figure 4-31. Fastener Examples (Ref. 3)

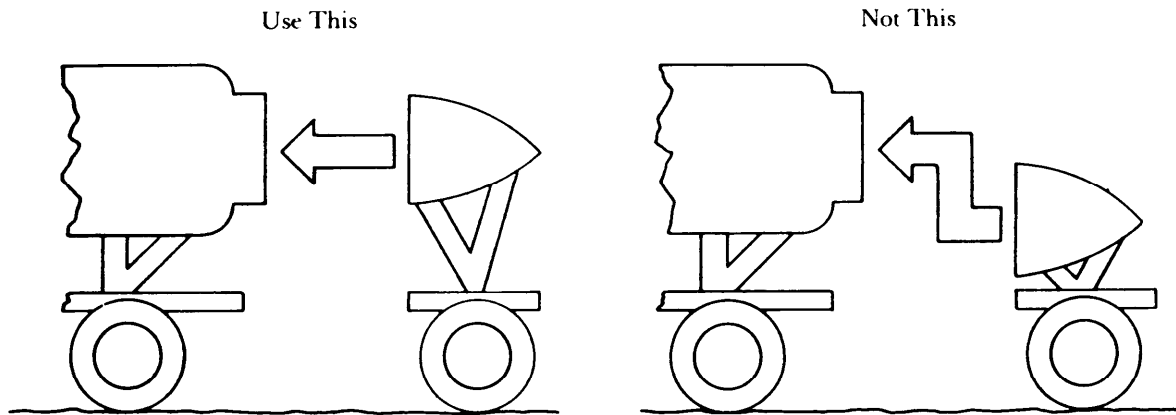


Figure 4-32. Mating Surface of Component Trailers

#### 4-6.4.2 Van Trailers

Van trailers generally are used to provide protected space for specific operations—e.g., command post, fire direction center, and computer center. Accordingly, for the access design features to enhance their maintainability, the appropriate paragraphs of this handbook should be consulted—e.g., if the van houses electronic and electrical equipment, refer to par. 4-6.1.

The chassis of the vehicles are made of commercial components which have been engineered for maintenance. Special consideration should be given to the routing of cables into and out of the van (see Figs. 4-27, 4-28, and 4-30). Ready access to filters—particulate, aerosol, and gas—should be available to permit changing from the inside so that air quality inside the van can be maintained.

#### 4-6.4.3 Stands

The proper work stand is important physically and psychologically in accomplishing a maintenance task efficiently and expeditiously—a stand is essentially one of the necessary tools to “do a job correctly”. Accordingly, if a stand is to be especially designed, it should embody features that maximize its use. Considerations in the design of stands follow:

1. Design maintenance stands so that they can be used on inclined surfaces of 15 deg without tipping when the weight of personnel and/or the component is concentrated on one side. Fig. 4-33 illustrates the advantage of a stand supported by two members instead of a single pedestal.

2. Use anchors or outriggers for stands that have high centers of gravity and that may be overturned by winds.

3. If stands are an integral part of the equipment, insure that personnel can reach all items they must manipulate without falling off.

4. Provide brakes for auxiliary stands equipped with wheels.

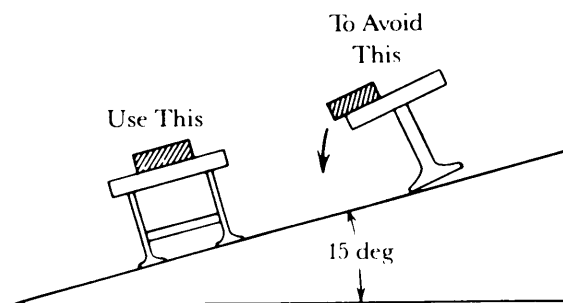


Figure 4-33. Physical Stability for Maintenance Stands

5. Design the walking surfaces on stands and platforms to afford good traction under all weather conditions.

6. Specify the use of engine stands which are slightly larger than the engine diameters to prevent damage from forklifts and other handling devices.

7. Use properly balanced and supported fuselage stands with low centers of gravity so that the stands will not tip under unevenly distributed weight.

8. Incorporate rails in the power plant shell structure where consistent with aerodynamic and weight requirements of the aircraft in order to roll the engine in and out of the shell. The rails should be matched to the height and size of the engine transporter dolly.

#### 4-6.5 TANK/AUTOMOTIVE MATERIEL

Accessibility of components in tank-automotive equipment can have a major impact on the maintenance indices of the vehicle. Design for accessibility should consider the following factors:

1. Type of maintenance
2. Maintenance environment
3. Task frequency
4. Performance and, or design considerations.

Each of these factors is discussed in the paragraphs that follow.

**4-6.5.1 Type of Maintenance**

As with other types of equipment, tank-automotive maintenance will be either corrective or preventive. The impact of accessibility on each type follows:

1. *Preventive Maintenance:*

Preventive Maintenance Checks and Services (PMCS) other than daily operator and/or crew checks normally will account for approximately 20% of total maintenance time. The overwhelming problem regarding PMCS—including daily checks is to reduce the time required for these services to the absolute minimum necessary. A daily PMCS checklist that cannot be executed by the crew in 20 min for a truck and 45 min for a tank will most likely be rushed over or ignored; therefore, optimum placement of components to be checked is critical. Assure good accessibility of fluid reservoirs, filters, and other checkpoints. Eliminate the need to remove armor plates or other obstacles in order to reach the components involved in the PMCS checklist. The quarterly PMCS checklist—which will include monthly services—should take no more than eight clock hours to perform. Semiannual and annual services naturally will take longer, but since they are performed less frequently, their contribution to total maintenance time, and hence the maintenance ratio, is not as significant.

Accessibility of a specific component may determine whether the part will be serviced during PMCS or allowed to fail. For example, a U-joint on a specific light combat vehicle was designed to be lubricated at the quarterly service. With this scheduled service, the reliability was effectively the life of the vehicle. However, the location of the U-joint necessitated removal of the power pack. Thus this quarterly lubrication required over 8 clock hours. The U-joint, therefore, was changed at a slight increase in cost to a permanently lubricated design with a projected mean time between failures (MTBF) of 1000 h and a replacement time—mean time to repair (MTTR)—of 9 clock hours. With an annual usage of 350 h, failure could be expected approximately once every three years. By accepting this small risk of failure—with approval from the user community—design engineers reduced the maintenance ratio and increased the availability of the system. A small increase in unit cost was traded off for a lower life cycle cost. If no other failures are assumed, the inherent availability calculations are

$$\begin{aligned} \text{Scheduled Service} &= \frac{\text{MTBM}}{\text{MTBM} + \text{MTTR}} \\ &= \frac{350/4}{(350/4) + 8} = 0.92 \\ \text{Run to Failure} &= \frac{\text{MTBF}}{\text{MTBF} + \text{MTTR}} \\ &= \frac{1000}{1000 + 9} = 0.99. \end{aligned}$$

2. *Corrective Maintenance.* Accessibility considerations and ground rules discussed in the beginning of this chapter can be applied to tank-automotive equipment. Time spent getting to the faulty part is wasted time. If it is assumed that reliability cannot be further improved, then the lower the expected reliability of a part, the more consideration should be given to its accessibility. Refer to the discussion on frequency of maintenance in par. 4-6.5.3.

**4-6.5.2 Maintenance Environment**

Tank-automotive equipment is unique in that maintenance will be required in most every imaginable environment. In peacetime, maintenance generally will be performed on a hardstand in a sheltered bay, often with power lift capability, and a pit. No such amenities will exist under wartime conditions. Do not rely on having a pit to gain access to maintenance or service points under the vehicle. Jack stands that support a vehicle on a hardstand may sink in soft ground or mud if not properly designed. Lift capability used to remove components for service or better access will not be available unless a mobile wrecker is called in. Also a component that is accessible under “classroom conditions” may not be accessible when caked over with hardened mud and debris.

**4-6.5.3 Task Frequency**

If a power pack is removed only once a year, it really is not important if the task requires 30 man-hours to perform. If the pack must be removed monthly, however, the contribution of this task to the total maintenance burden is multiplied by 12. The importance of task frequency to the total maintenance burden is shown in Tables 4-3 and 4-4. Table 4-3 lists the top ten replacement parts, by frequency of occurrence, for two types of vehicles. Table 4-4 lists the top ten replacement parts, by man-hours to replace, for the same vehicles.

**TABLE 4-3. LIST OF TOP TEN REPLACEMENT PARTS BY FREQUENCY OF OCCURRENCE**

M113 Family (Ligh Combat Vehicle)		M915 Series (Heavy Tactical Truck)
Engine Oil	Decreasing Frequency ↓	Gear Shift
Transmission Oil		Gasket
Track Pads		Cable
Antifreeze		Shaft
Track Shoes		Breather
Fuel Filter		Tire
Rubber Cushion		Fuel Filter
Oil Filter		Oil Filter
Road Wheel		Air Filter
Battery		Battery

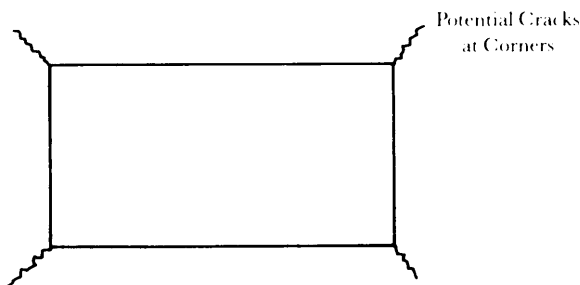
**TABLE 4-4. LIST OF TOP TEN REPLACEMENT PARTS BY MAN-HOURS TO REPLACE**

M113 Family (Ligh Combat Vehicle)		M915 Series (Heavy Tactical Truck)
Track Shoe	Decreasing Man-Hours ↓	Engine Valve
Engine		Insert
Engine Oil		Seal
Transmission		Tire
Rubber Cushion		Spring
Road Wheel		Transmission
Sprocket		Gasket
Final Drive		Fuel Filter
Transmission Oil		Oil Filter
Battery		Air Filter

For combat vehicles, track is usually the number one maintenance burden. An accessible location for breaking and joining track is essential if the time to perform track maintenance is to be minimized. For all tank-automotive equipment, engine oil and filter change also is a significant contributor to total maintenance time. In general, the maintainability engineer should place emphasis on those items in Table 4-4 since they are the top contributors to the maintenance burden. Tasks such as replacing the gearshaft are performed more often than replacing the engine valve, but they do not add as much to the total maintenance burden.

**4-6.5.4 Performance and/or Design Considerations**

Because tank-automotive equipment is mobile, it is subject to dynamic stress and strain. To maintain vehicle integrity regarding stress and strain calculations, accessibility must be considered during design and not as an afterthought. For example, rectangular hull access panels have maximum stress at the corners (Fig. 4-34). The optimum solution from a stress consideration is a circular access hole. However, this shape access may be totally impractical from the viewpoint of production, i.e., cutting or machining difficulties. A reinforced edge around the perimeter of the rectangular access may serve to strengthen the hull and prevent cracking. The use of the access



**Figure 4-34. Corner Stress Cracks**

plate in the first place, however, may degrade ballistic protection. The goal is to conduct the appropriate accessibility performance trade-offs to arrive at the optimum system design.

**4-6.6 ARMY MARINE EQUIPMENT**

The accessibility of marine components that may require maintenance is affected by fouling, i.e., the growth of animals and plants on the surfaces of submerged objects. A principal source of trouble is the fouling in pipes and conduits used to conduct water inside ships. For example, fouling may prevent closure of an isolation valve that must be closed to access a failed component. Fouling can make underwater structural repairs difficult or impossible. Consequently, more ships will require dry-dock facilities, i.e., making dry docks less available.

Fouling is controlled primarily by the selection of appropriate materials of construction and the use of protective coatings such as paint. The common antifouling paints contain copper, mercury, or arsenic compounds in various combinations; concentrations of about 1 milligram per liter are effective in reducing fouling. Diisobutyl phenol and chlorophenarsamine are considered very effective in combatting fouling. As a preventive measure, pipes and conduits should be made of bronze or other copper alloys because these materials are the least likely to foul.

**4-6.7 AIRCRAFT (Refs. 4 and 5)**

Aircraft components that require maintenance should be easily accessible. However, the designer should consider the expected frequency of maintenance to determine the degree of accessibility and to insure that the effort expended to provide accessibility is warranted.

**4-6.7.1 General Inspection and Access Requirements**

The aircraft designer should provide every possible convenience for performing periodic inspections and replacements of functional components in a minimum period of time and for decreasing possible in-flight hazards. Some design recommendations that merit consideration follow:

1. Do not use doors that are welded or riveted to the airframe, panels, or other accesses requiring the removal of permanently attached structures.
2. Provide doors or access panels in the fuselage, airfoils, nacelles, control surfaces, and any location not otherwise accessible from the interior for the inspection and servicing of actuators, controls, jack screws, pulleys, cables, guides, electric junction boxes, the Pitot-static system, fuel tanks and system, boost pumps, and similar items.
3. Uniquely mark all removable inspection and access doors or otherwise identify their locations to expe-

dite reinstallation. When hinged doors are used, locate the hinges so that the airstream tends to keep them closed.

4. Provide a door opening of at least 150 deg, preferably 180 deg. Piano hinges may be used and are desirable as locking devices for inspection and access doors.

5. Do not locate inspection or access doors on the engine air intake duct or near its opening because they might be sucked into the engine if they become unfastened.

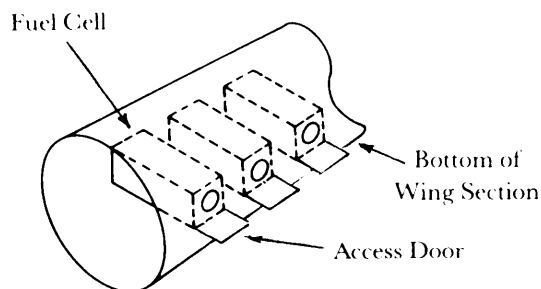
6. Use flush, quick-opening fasteners on inspection doors that conform to MIL-F-5591 (see Fig. 4-31 for examples). Do not use screw-retaining doors when frequent inspection, servicing, or maintenance is required.

7. Design access doors and cowling so that when closed the fasteners do not appear fastened if they are not. Unlatched cowlings have been lost in flight, with resultant aircraft damage, due to this design inadequacy.

8. Size and locate all inspection and access panels so that a mechanic dressed in arctic clothing, including gloves, may accomplish the necessary work. (See Fig. 4-15 and Chapter 9.)

9. Provide each fuel cell with its own access door from the exterior of the aircraft. (See Fig. 4-35.) Access to fuel cells in large aircraft presents special problems because of the number of separate fuel cells and the complexity of the interconnecting and regulating hardware in and around the cells. In a large aircraft there may be hundreds of valves, float switches, circuit breakers, fuel manifolds, or clamps. Accordingly, inspection, troubleshooting, replacing, and repairing become formidable tasks. Where possible, the complexity a subsystem should be reduced. Reducing the number of parts in a subsystem will improve access for maintenance.

10. Where possible, make equipment accessible for in-flight maintenance and operation. Place equipment requiring access, operation, or adjustment during flight within easy reach of the operator. During flight when crew members are properly restrained, i.e., shoulder harnesses and seat belt fastened, components that require adjustment should be within easy reach. Crew members should not be required to release themselves from ejection seats.



**Figure 4-35. Provide Access Door for Each Fuel Cell**

11. Make control components accessible for inspection and maintenance; make actuators accessible for stroke adjustment and replacement of motor brushes. Temperature-setting adjustments on thermostatic controls should be readily accessible, and test points required for checking waveforms, voltages, hydraulic pressure, and gas pressure should be readily available and identifiable (see Chapter 9).

#### 4-6.7.2 Propulsion Systems

Ease of accessibility to all parts of the power plant will minimize the time and manpower required for maintenance. The designer should consider the accessibility of all parts for inspection, cleaning, and adjustment. Removal of components for servicing should be possible with a minimum need to remove other parts of the power plant or aircraft. Without neglecting vulnerability the layout of these components should allow a maximum number of mechanics to work on the installation with minimum interference from one another.

Tables 4-5 and 4-6 list engine accessories that should be accessible for inspection, cleaning, and adjustment while installed on the aircraft without removal of the engine, fuel tanks, or other important parts of the aircraft structure. Table 4-5 is for reciprocating engines; Table 4-6, for turbine engines. The tables also list the accessories that should be accessible for removal or replacement. These accessories should be designed or arranged so that only tools normally found in the mechanic's tool kit are needed for the required work.

Additional accessibility design recommendations for propulsion systems follow:

1. Provide access to engine parts and accessories without necessitating removal of the ring cowling.
2. Provide large, quick-opening access doors and sufficient space in the engine accessory area for servicing and replacing of components.
3. Hinge aircraft skin, where possible, for ease of access to engine maintenance tasks.
4. Use split-line design whenever possible for maximum accessibility to engine components. For example, split the compressor and combustion chamber housings for easy inspection, service, or removal of blades and cannular chambers.
5. Design engine rail brackets as a part of the main chassis to facilitate removal of the engine.
6. Design engine mounting in normal installations—e.g., the engine is installed in the nose or in the nacelle—so that the mount, complete with cowling, is readily detachable.
7. To facilitate quick power plant changes, use self-aligning mounting bolts employing ball-and-socket or tapered ends. This type of fastener should be used only where stress requirements permit.
8. For maximum access mount the accessory gear

**TABLE 4-5. RECIPROCATING ENGINE ACCESSORIES THAT SHOULD BE ACCESSIBLE FOR INSPECTION, CLEANING, ADJUSTMENT, REMOVAL, AND REPLACEMENT**

Inspection, Cleaning, and Adjustment

Magneto breaker points	Carburetor or fuel injection system
Oil pressure relief valve	Carburetor air filters
Oil tank	Suction relief valve
Oil cleaner or strainer	Feathering pump
Fuel tank	Propeller governor
Fuel pressure relief valve	Turbosupercharger
Fuel strainer	Turbosupercharger regulator
Drain valves	Automatic controls

Removal and Replacement

Spark plugs	Water injection pump
Magneto	Exhaust stacks and collector
Starter	Flame damper
Generator	Exhaust gas heat exchanger
Tachometer generator	Turbosupercharger
High tension wiring	Turbosupercharger regulator
Radio shields	Automatic engine controls
Temperature control actuator	Suction relief valve
Temperature control actuator motor brushes	Vacuum pump
Oil tanks, not integral	Hydraulic pump
Oil cleaner or strainer	Deicing pump
Oil pump	Accessory gear drive
Oil pressure relief valve	Cabin supercharger (mechanical)
Oil booster pump	Fuel injection pumps
Fuel pump	Fluid shutoff valves
Fuel booster pump	Oil cooler
Fuel strainer	Oil cooler control valve
Carburetor fuel strainer	Fuel injection control
Carburetor air filter	Carburetor or fuel injection system

drives and their related accessories in the bottom, or six o'clock, engine position along the compressor section because present aircraft design makes this the most accessible position.

9. Mount engine accessories so they are accessible for inspection, cleaning, adjustment, or removal without removal of the engine or other important power plant structures.

10. Design the power plant installation so that all daily and preflight inspections can be made in cold weather when the operator is wearing heavy gloves and body clothing. In particular, provide proper accessibility to fuel and oil drains.

11. Provide an opening in the engine cowling for ground heaters. This opening should have either an accessory door with a minimum diameter of 305 mm (12 in.) or an easily removable section of cowling of equivalent size. Locate the door or opening so that it may be used for convenient servicing of oil and fuel drains. Consider grouping the drains, especially the main oil and oil tank sump drains, near the accessory door opening. Stencil the

accessory door or cowling section with "OPEN FOR GROUND HEATER DUCT".

12. In turbine-powered aircraft adequate provisions should be incorporated into the cooling system and structure for rapid inspection, repair, and replacement of the tailpipe, flexible coupling, and all components of the system, such as ejector shroud, insulation blanket, cooling-air shutters, diverters, and controls. If the system design incorporates an ejector shroud, it should be fabricated or assembled on the tailpipe so that it is removable with this unit.

13. Design the turbine with a removable housing so that the rotor blades are visible. This feature makes inspection of every blade possible by rotation of the turbine wheel.

14. Mount the turbine stator and rotor blades so they can be removed, inspected, and installed individually by hand (see Fig. 4-36). If it is necessary to change a blade, the retaining plate is unscrewed and blades are slipped out by hand and inspected. When a damaged blade is reached, a new blade is slid in, and the retaining plate is replaced.

**TABLE 4-6. TURBINE ENGINE ACCESSORIES THAT SHOULD BE ACCESSIBLE FOR INSPECTION, CLEANING, ADJUSTMENT, REMOVAL, AND REPLACEMENT**Inspection, Cleaning, and Adjustment

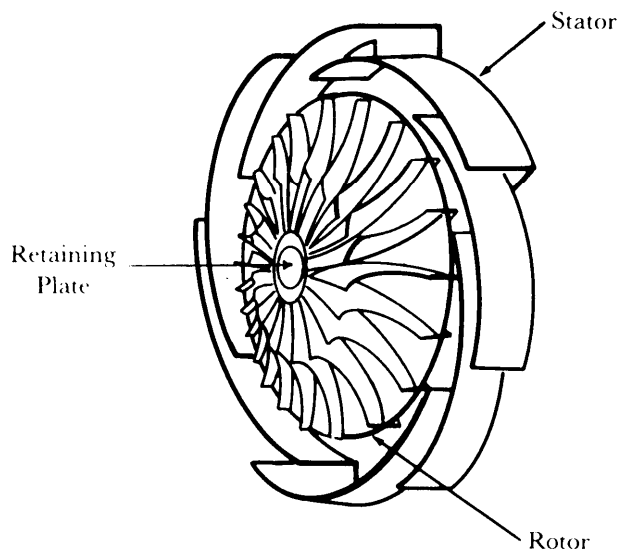
Main fuel control  
 Starting fuel control  
 Emergency fuel control  
 Governor (speed)  
 Suction relief valve  
 Actuator motor brushes  
 Automatic controls  
 Sump plugs and drain valves  
 Spark plugs

Variable nozzle area unit and control  
 Oil pressure relief valves  
 Oil tank  
 Oil cleaner or strainer  
 Fuel filter  
 Fuel pressure relief valve  
 Fuel nozzle  
 Barometric unit (fuel control)  
 Control valve (idling speed)

Removal and Replacement

Oil cleaner or strainer  
 Oil pump  
 Oil pressure relief valve  
 Oil cooler  
 Oil temperature relief valve  
 Booster pump  
 Fuel pump  
 Fuel strainer  
 Fuel regulator unit or control unit  
 Fuel nozzle  
 Drip valve  
 Flow divider (fuel system)  
 Pressure bypass valve (fuel system)  
 Main fuel control  
 Starting fuel control  
 Emergency fuel control  
 Thermal unit (fuel system)  
 Barometric unit (fuel control)  
 Water tank or thrust augmentation fluid tank  
 Automatic engine controls  
 Drain valves

Spark plugs  
 Ignition coil  
 Starter  
 Generator  
 Tachometer generator  
 High tension wiring  
 Radio shielding  
 Temperature control actuator  
 Temperature control actuator motor brushes  
 Oil tanks, not integral  
 Suction relief valve  
 Vacuum pump  
 Hydraulic pump  
 Accessory gear drive  
 Air filter (bearing cooling)  
 Air filter (vents)  
 Tailpipe (extension)  
 Reducer (variable nozzle area)  
 Governor (RPM)  
 Oil shutoff valve

**Figure 4-36. Mount Stator and Rotor Blades to Facilitate Removal of Individual Blades****4-6.7.3 Landing Gears**

Consider the following accessibility recommendations in the design of landing gear:

1. Design all units of the alighting gear to be accessible for lubrication, service, inspection, and replacement.
2. Design all hydraulic mechanisms so that their filler plugs, bleeder plugs, and air valves may be readily serviced with air and fluid.
3. Provide sufficient clearance between the shock absorber packing gland nut and adjacent parts of the aircraft when the shock absorber is fully deflated so that the nut may be readily adjusted with a wrench.
4. Design all shock absorber struts so that the extent of inflation may be determined without removing the cowling or using any measuring device other than a scale.

**4-6.7.4 Mechanical Items**

Consider the following accessibility recommendations in the design of mechanical items:

## DOD-HDBK-791(AM)

1. Provide the greatest accessibility for either the removal of bearings for bench relubrication or their purging and relubrication in the aircraft. This requirement stems from the need to replace bearings and change lubricant to suit the range of temperatures and conditions at which certain aircraft may operate.

2. In using split bearings optimize accessibility by making the plane of the split correspond with access ports. For example, split the crankshaft bearing on an engine connecting rod to permit removal of the bearing through an external access without removing the crankcase cover.

3. To permit changing of the bearings without disassembly of the entire component, mount two bearings in tandem rather than using a single bearing of larger size. This will permit changing one bearing while the other bearing supports the load.

4. Where accesses are located over dangerous mechanical components, design the access door so that it turns an internal light on automatically when opened. Also provide a highly visible warning label on the access door.

### 4-6.7.4.1 Drawer-Type Housing

Assemblies, such as instrument panels and electrical and hydraulic units, can be made more accessible by the use of drawer-type housings. Basically, a unit should be made up of a housing with many cavities. Each cavity should contain a component that would serve, as far as practical, a separate portion of the overall system. The overall unit should be mounted on a rugged frame with the front cover also serving as the control panel for the enclosed compartments. The frame should be supported by hinges that come apart readily to permit withdrawal of the whole component. Rests, limit stops, guards, and/or retaining devices should be provided as part of the basic chassis to prevent the unit from falling from the aircraft. No special tools should be required to withdraw the component. The front panel of the component should have a

dust seal to prevent contaminants from entering the cavity in the housing. When ventilation is required to cool the cavity, suitable filters should be installed in the ventilating intake and exhaust ducts. Component test points, if required, should terminate at an easily accessible terminal board or strip.

The design of drawer-type housings offers the following desirable maintenance features:

1. The component may be withdrawn and rapidly calibrated, serviced, inspected, or repaired.

2. The component may be removed completely from the housing, placed on a bench in front of the housing, and, with the use of an adapter cable(s), serviced and maintained with full access to the component.

3. The component may be taken to a test area and repaired, calibrated, tested, or inspected under ideal conditions.

4. The component may be replaced with an identical unit from stock, which rapidly returns the system to availability.

### 4-6.7.4.2 Major Unit Housings

Major unit housings, such as engine nacelles, should have hinged or removable housings that can be rapidly opened and closed for inspection and repair. The fasteners required to secure the housings should be kept to a minimum and should be removable with speed tools, such as speed wrenches and screwdrivers.

## 4-7 ACCESSIBILITY CHECKLIST

Table 4-7 summarizes the important design recommendations to be considered when designing for maintainability. The checklist contains several items that are not discussed separately in the text. These items are included here because their necessity in the design is so obvious that they might otherwise be overlooked. If the answer to any item on the checklist is "no", the design should be reexamined to determine the need for correction.

**TABLE 4-7**  
**ACCESSIBILITY CHECKLIST**

**A. GENERAL:**

1. Is optimum accessibility provided in all equipment and components requiring maintenance, inspection, removal, or replacement?
2. Is a transparent window or quick-opening metal cover used for visual inspection accesses?
3. Are access openings without covers used where they are not likely to degrade performance?
4. Is a hinged door used where physical access is required (instead of a cover plate held in place by screws or other fasteners)?
5. If lack of available space for opening the access prevents use of a hinged opening, is a cover plate with captive, quick-opening fasteners used?
6. Are parts located so that other large, difficult-to-remove parts do not prevent access to them?
7. Are components placed so that there is sufficient space to use test probes, soldering irons, and other required tools without difficulty?
8. Are units placed so that structural members do not prevent access to them?
9. Are parts mounted on a single plane, i.e., not stacked one on another?
10. Are components placed so that all throwaway assemblies or parts are accessible without removal of other components?
11. Is equipment designed so that it is not necessary to remove any assembly from a major component to troubleshoot that assembly?
12. Are units laid out so that maintenance technicians are not required to retrace their movements during equipment checking?
13. Can screwdriver-operated controls be adjusted with the handle clear of any obstruction?
14. When adjustments with a screwdriver must be made by touch, are screws vertically mounted so that the screwdriver will not fall out of the slot? Are Phillips head or Allen head screws used rather than slotted ones?
15. Is enough access room provided for tasks that necessitate the insertion of two hands and two arms through the access?
16. If the maintenance technician must be able to see what he is doing inside the equipment, does the access provide enough room for the technician's hands or arms and still provide an adequate view of what he is to do?
17. Are irregular extensions, such as bolts, tables, waveguides, and hoses, easy to remove before the unit is handled?
18. Are units removable from the installation along a straight or moderately curved line?
19. Are heavy units (more than about 110 N (25 lb)) installed within normal reach of a technician for purposes of replacement?
20. Are provisions made for support of the units while they are being removed or installed?
21. Are rests or stands provided on which units can be set to prevent damage to delicate parts?
22. Is split-line design used wherever possible and necessary?
23. Are access points individually labeled so they can be easily identified with nomenclature in the job instructions and maintenance manuals?
24. Are accesses labeled to indicate what can be reached through this point (label on cover or close thereto)?
25. Are accesses labeled to indicate what auxiliary equipment is needed for service, checking, etc., at this particular point?
26. Are accesses labeled to specify the frequency for maintenance either by calendar or operating time?
27. Are parts that require access from two or more openings marked to so indicate to avoid delay and/ or damage by trying to repair or remove through only one access? Are double openings of this type avoided wherever possible?
28. Are human strength limits considered in designing all devices that must be carried, lifted, pulled, pushed, and turned?
29. Are environmental factors (cold weather, darkness, etc.) considered in design and location of all manipulatable items of equipment?
30. When necessary, are internal parts illuminated?
31. Are fuses located so that they can be seen and replaced without removal of any other item?
32. If fuses are clustered, is each one identified?
33. Are fuse assemblies designed and placed so that tools are not required for replacement?

(cont'd on next page)

**TABLE 4-7 (cont'd)**

**B. ACCESS DOORS AND COVERS:**

1. Are clearance holes for mounting screws in cover plates oversize to obviate the need for perfect alignment?
2. Are the cases designed to be lifted off units rather than for the units to be lifted out of the cases?
3. Are the cases made larger than the units they cover to preclude damage to wires and components?
4. Are guides or tracks provided to prevent the cocking of the case to one side?
5. If the method of opening a cover is not obvious, are instructions provided on the outside of the cover?
6. When covers are not in place and secure, are means provided to make this error obvious?
7. Are no more than four fasteners used to secure the case?
8. Is the same type of fastener used for all covers and cases on given equipment?
9. Are ventilation holes with screening of small enough mesh provided to prevent entry of probes or conductors that could inadvertently contact high voltages?
10. Are access doors made in whatever shape is necessary to permit passage of the components and implements that must pass through?
11. On hinged access doors, is the hinge placed on the bottom or is a prop provided so that the door will remain open without being hand-held?
12. If maintenance instructions are placed on the door, are letters oriented to be read when door is open?
13. Because military equipment must be maintained on ground covered deep in mud or snow, in extreme temperature, and tactical blackout at night, do access doors permit equipment to be maintained from above rather than below and from inside rather than outside?

**C. HANDLES:**

1. Are handles used on units weighing over 45 N (10 lb)?
2. Are handles provided on smaller units that are difficult to grasp, remove, or hold without using components or controls as handholds?
3. Are handles provided on transit cases to facilitate the handling and carrying of the unit?
4. Are handles placed above the center of gravity and positioned for balanced loads?
5. For handles requiring a firm grip, are bale openings at least 115 mm (4.5 in.) wide and 50 mm (2.0 in.) deep?
6. Do handles have a comfortable grip while the unit is being removed or replaced?
7. Are handles placed where they will not catch on other units, wiring, or structural members?
8. Are recessed handles located near the back of heavy equipment to facilitate handling?
9. Are handles located to prevent accidental activation of controls?
10. Are handles placed to serve as maintenance stands for equipment?
11. For heavy equipment that requires two people for lifting, are four standard size grips or two large size grips provided?
12. Are handles or other suitable means for grasping, handling, or carrying provided on all units designated to be removed or replaced?

**D. WIRE AND CABLE:**

1. Are electrical cables of sufficient length so that each functioning unit can be checked in a convenient place?
2. Is it possible to move units that are difficult to connect, when installed, to convenient positions for connecting and disconnecting?
3. Are cables and lines directly accessible to the technician wherever possible, i.e., not under panels or floorboards, which are difficult to remove?
4. Are cables routed so they need not be sharply bent or unbent when being connected or disconnected?
5. Are cables and wire bundles routed so they cannot be pinched by doors or lids, or so they will not be stepped on or used as handholds by maintenance personnel?
6. Are means provided for pulling out drawers and slide-out racks without breaking electrical connections when internal, in-service adjustments are required; for reeling cabling when drawers and racks are returned to their positions?
7. Are parts mounted on one side of a surface with associated wires on the other side?

(cont'd on next page)

**TABLE 4-7 (cont'd)**

8. Is a 75-mm (3.0-in.) minimum clearance provided wherever possible between control cables and wiring, or is a physical means provided to prevent chafing? (The designer must anticipate a potential chafing hazard.)
9. Is electrical wiring routed away from all lines that carry flammable fluids or oxygen?
10. Is care taken in the design of cable conduits to prevent collection of water or debris, which could interfere with operation of a control system (freezing or short circuiting)?
11. Is the necessity for removing connectors or splicing lines avoided?
12. Is direct routing through congested areas avoided wherever possible?
13. Are cable entrances on the fronts of cabinets avoided where it is apparent they could be “bumped” by passing equipment or personnel?
14. Are adjacent solder connections far enough apart so work on one connection does not compromise the integrity of adjacent connections?

**E. SAFETY:**

1. Are access openings free of sharp edges or projections that could injure the technician or snag clothing?
2. Are parts that retain heat or electric charge after equipment is turned off located so that the technician is not likely to touch them while servicing the equipment? If this potential hazard cannot be avoided, does the access door contain a label alerting the technician to the hidden hazard?
3. Are access doors located away from moving parts or do they conceal moving parts that present a potential hazard? If the concealed hazard cannot be avoided, does the access door contain a label alerting the technician to this hazard?
4. Are internal controls—switches and adjustment screws—located away from dangerous voltages or moving parts?

**REFERENCES**

1. MIL-STD-882B, *System Safety Program Requirements*, 30 March 1984.
2. DA PAM 750-40A, *Guide to Reliability Centered Maintenance (RCM) for Fielded Equipment*, 15 February 1980.
3. MIL-HDBK-759, *Human Factors Engineering Design for Army Materiel*, 31 December 1985.
4. J. W. Altman, et al., *Guide to Design of Mechanical Equipment for Maintainability*, ASD-TR-61-381, Wright-Patterson Air Force Base, OH, August 1961.
5. P. H. Newman and G. L. Murphy, *Human Factors Handbook, Vol. III, For Design of Protective and Storage Ground Support Equipment*, AFSWC-TR-59-13, Air Force Special Weapons Center, Kirtland Air Force Base, Albuquerque, NM, 1959.

**BIBLIOGRAPHY**

F. L. Ankenbrandt, et al., *Maintainability Design*, Engineering Publishers, 1963.

Blanchard and Lowery, *Maintainability Principles and Practices*, McGraw-Hill, New York, NY, 1969.

Cunningham and Cox, *Applied Maintainability Engineering*, John Wiley and Sons, New York, NY, 1972.

Arsenault and Roberts, *Reliability and Maintainability of Electronic Systems*, Computer Science Press, Potomac, MD, 1980.

D. J. Smith and A. H. Babb, *Maintainability Engineering*, Pitman Publishing, New York, NY, 1973.

**This page intentionally left blank.**

## CHAPTER 5 MODULARIZATION

*The role of modularization in reducing maintenance time and improving operational availability is discussed. The advantages and disadvantages of throwaway modules are presented. Guidelines are listed to assist the engineer in deciding on the physical attributes of a module and techniques of component grouping. Examples of the application of the modular concept to Army materiel are given. A design checklist for modularization is presented.*

### 5-1 INTRODUCTION

The support concept for a new system ultimately consists of a series of support requirements—one set for each level of support together with the procedures, techniques, and services needed for satisfactorily meeting each requirement. Every system must be provided with its unique support plan designed to meet its peculiar needs. As has been mentioned in previous chapters, the determination of the support requirements depends to a considerable extent on the operational requirements of the system in question. For example, the operational availability desired for a system may dictate a mean downtime requirement of such short duration that it can be met only by providing for a maximum repair capability at the unit level. Because this requirement maintenance at the user level usually employs personnel with limited skills for support work, a need for designing the system for easy identification and isolation of faults is established. The additional requirement that rapid repair be facilitated once a fault has been identified calls in turn for modular design. Once these steps have been taken, general guidance principles to govern the design evolve, e.g.,

1. Modules will be removable by user personnel without the use of special tools.
2. Modules will be interchangeable without the requirement for maintenance adjustments.
3. Modules will cost no more than a given amount or will not cost more than a given amount to repair. (This is to make throwaway at the user level economically feasible.)
4. Modules will be replaced within a specified period of time, i.e., a maximum limit on time to replace module. (This is necessary to meet the downtime requirement for the system as a whole.)

This discussion leads to the definition of a module i.e., “A module is a part, subassembly, assembly, or component designed to be handled as a single unit to facilitate supply and installation, operations, and or maintenance.” It can be either repairable (at the intermediate or depot level) or nonrepairable (discard-at-failure). Modularization is achieved by dividing equipment into physically and functionally distinct parts or modules. The

module must be functionally complete to permit testing and verification apart from interfacing items. Thus modularization enables subsystems, assemblies, and subassemblies to be designed as removable entities that can meet the criteria for line-replaceable units (LRUs). (An LRU is an item whose removal and replacement with a like serviceable item is considered the optimum method of repair or restoration of a higher order system.)

The modularization concept is not confined exclusively to hardware items; software modules also lend themselves to this concept. Software modules are discussed in par. 5-4.

### 5-2 ADVANTAGES

The concept of modularization creates a divisible configuration that is more easily maintained. Troubleshooting and repair of modularized assemblies, therefore, can be performed more rapidly. Use of this technique to the maximum improves accessibility, makes possible a high degree of standardization, provides a workable base for simplification, and provides an optimum approach to maintainability at all maintenance levels.

To realize these advantages, the module should be

1. Easily identified or determined without the use of sophisticated test equipment and procedures to have failed or malfunctioned: failure should be recognizable at the module level rather than at the system level of which the module is a part.
2. Readily and easily accessible (see Chapter 4); the need for accessibility to be in direct ratio to the specific failure rates of the modules
3. Replaceable in less time and with fewer technicians with a lesser skill level than would be possible by repair-in-place
4. Replaceable by technicians without the need for special tools and instructions. Mating connections between module and end-item should be easily recognized so that the module may be quickly detached and replaced without recourse to maintenance manuals for instructions.
5. Designed to be emplaced without adjustment or calibration in order to be compatible with the system

## DOD-HDBK-791(AM)

6. Designed if not a "throwaway" (see par. 5-3) to insure that components of the module are accessible so that a higher level of maintenance can service or repair the components

7. Designed for standardization and interchangeability (see Chapter 3) if the same function is performed in other subassemblies of the overall system.

Additional advantages of modular design are

1. New equipment design may be simplified and design time may be shortened by using previously developed standard "building blocks", i.e., modules. Of course, the building blocks must be consistent with the reliability, compatibility, and integrated system testing requirements of the adopted system.

2. Current equipment can be modified in service when newer and better functional units become available provided the new unit does not affect input-output characteristics.

### 5-3 THROWAWAY MAINTENANCE

#### 5-3.1 GENERAL

Modularization lends itself to throwaway maintenance. Strictly defined, throwaway maintenance is a maintenance policy whereby components or items of equipment to a given level are discarded at failure rather than repaired. It embraces the terms "discard-at-failure" maintenance and "nonmaintenance design". As a policy, it is based on the principle that every system design has a level of repair at which it is more practical and economically feasible to throw away a failed item or component than it is to repair that item or component.

The level of throwaway to be selected for a given design is dependent on many factors and may be established at any point between the complete system and any of the piece parts of its subsystems. The higher levels of throwaway obviously provide for increased system availability, but they may dictate costs of such magnitude that a lower level must be chosen. Higher levels of throwaway are universally acceptable whenever costs are not a determining factor.

As a means of increasing the availability of equipment, throwaway maintenance is a logical extension of the "maintenance float" concept. This maintenance concept, i.e., the need to have major items of equipment on hand to replace or substitute for equipment removed from service for either scheduled or unscheduled maintenance, has been used by industry and the Army. Since most of the items in this category are expensive, costs preclude their discard—hence a pool of repaired items as well as new replacement items. On the other hand, no one would consider attempting to repair an electrical fuse, a light bulb, or a fan belt; such items would be thrown away, and new ones substituted. Somewhere between these two

extremes is the optimum level of throwaway for system design. Selection of that level for a given system depends not only on the cost of initial hardware procurement—as weighted by availability requirements—but also on the user's support costs. It is obvious that trade-off procedures involving the designer, maintainability engineer, and user must be resorted to in order to determine the throwaway level to be adopted. Another strategy would be a peacetime-wartime concept, i.e., save and repair failed modules during peacetime but dispose of them during wartime.

#### 5-3.2 ADVANTAGES

Among the typical advantages obtained by selecting a high throwaway level for a given system that is being designed are the following:

1. Costs of record keeping are drastically reduced because the number of expendable items is high.

2. Because the number of line items needed to support a system is drastically reduced, the possibility is increased that a part needed to repair a malfunctioning system will be available.

3. Greater possibility in packaging is afforded because access to the interior of throwaway modules is not required; this makes possible both a very high packaging factor and greatly reduced overall volume.

4. System reliability is increased by the extent to which unitized packaging makes possible encapsulation with its protection against corrosion and humidity, and the use of rigid assemblies with their high resistance to shock and vibration with fewer make and break connections.

5. Periodic replacement of assemblies (modules) because of normal failure makes possible a system that is, for all purposes, rebuilt. This feature is not exclusive to throwaway maintenance.)

6. In-line changes that do not affect input-output characteristics can be made in assemblies without additional repair parts and without changes in field documentation being required.

7. Manufacturing costs per unit are minimized not only because the volume of production is increased, but also none of the assemblies are designed to be repairable.

8. Modifications and all problems associated with them are minimized because design imperfections can be corrected by changes being made in the complete module.

9. Documentation of equipment is reduced because the user or maintenance personnel do not need to know the internal makeup of individual assemblies.

10. Requirements for maintenance personnel and their respective skill levels are reduced because assemblies are replaced, not repaired. Similarly, test equipment requirements are reduced. This results in considerable savings in many areas—e.g., manpower, training, facili-

ties, documentation, repair parts, and the test equipment itself.

### 5-3.3 HAZARDS

Application of the throwaway concept creates several important hazards, each of which requires provisions to prevent the development of major disadvantages. These hazards are

1. The frequent failure of a single, relatively inexpensive component necessitates discard of an expensive assembly, which results in increased maintenance dollar costs. The obvious counteraction to be taken is the use of components of approximately equal reliability in each assembly. This should be required even if more expensive components are required to obtain an approximation of equal reliability.

2. Frequent failure of a module, resulting in discard, does not reveal the cause of failure. A postmortem analysis of the failed module may discover that (a) the same component causes failure and, if replaced by a more reliable one, could extend the life of the module considerably or (b) the module is a victim of a false alarm that erroneously signals failure of the module, i.e., the monitoring or diagnostic equipment is at fault.

3. Procurement times for assemblies tend to be greater than those for components, which possibly leads to excessive system downtime. To prevent this, increased emphasis must be placed on stocking the critical items in sufficient quantities at the unit level.

4. The technical capability of the personnel of the unit in the area of self-support generally deteriorates because of the decreasing need for piece-part repair activities. Obviously, one of the objectives of throwaway maintenance is the elimination of a requirement for high skill levels for technicians.

Accordingly, a decision to adopt a high-level throwaway concept for the design of a system is predicated on a number of conditions, i.e.,

1. Replacement assemblies should be available in adequate quantities at the user level.

2. The reliability of components within each assembly should be approximately equal.

3. The reliability of the assemblies comprising a system should be sufficiently high to compensate for their relatively high cost.

Despite these hazards and conditions, wherever considerations of operational availability are paramount, a definite attempt should be made to design a system for employment of throwaway assemblies.

### 5-4 SOFTWARE MODULES

Software modules are similar to hardware modules in that they may be designed to perform specific functions. Software modular design, however, cannot be applied to

all types of equipment with equal advantage. Its greatest application is in electronic equipment to monitor or determine the status of a circuit, subassembly, or system; diagnose or troubleshoot a failure or malfunction; or perform a self-check on an item of test equipment. Separate programs (modules) can be written, using the same microprocessor, to perform each of these functions for each of the different hardware modules that requires it.

The advantages of software modularization are (Ref. 1)

1. By using tailored software programs, i.e., focusing on a specific item or function, the software is less complex. Therefore, it requires less frequent maintenance and fewer steps to locate a fault. Programs can be readily changed to accommodate a retrofit replacement item.

2. Lesser routines maybe more easily understood by those responsible for subsequent program maintenance.

3. Less likelihood that a modification to a specific program will affect other programs. This reduces the possibility of maintenance-induced failures.

4. The number of discrete problems possible in a specific subroutine is often many orders of magnitude less than the number possible in the complete overall program. Thus testing is more manageable. Software modules can be tailored to the demands of the system components.

5. Software programs can be easily modified based on operational experience.

6. Imperfections in module software that remained unidentified up to the time of failure—although they were introduced when the software was originally written or subsequently modified—can be corrected without impacting the complete system.

## 5-5 DESIGN CRITERIA

### 5-5.1 MODULARIZATION VERSUS PIECE-PART DESIGN

The general criteria for modularization versus piece-part design are

1. *Feasibility.* Feasibility criteria often lead to a quick decision; if it is not within the state of the art to develop a modularized design as an alternative, piece-part design wins by default.

2. *Life Cycle Cost.* When modularization is a feasible alternative, its cost-effectiveness must be considered as it applies to the life cycle of the item. The cost aspect is particularly important if a throwaway module is being considered.

3. *Compatibility With Logistical Support Plan.* Most “module versus piece-part” decisions are made to satisfy the demands imposed by the logistical support plan to accommodate the operational demands of the system. The requirement for immediate repair at the unit level by unskilled personnel demands modular replacement (see par. 5-1).

Guidelines to assist the designer in the “module versus piece-part” consideration are presented in the paragraphs that follow.

### 5-5.1.1 General "Module Versus Piece-Part" Criteria

The following are general considerations in the trade-off between modular and piece-part design: (A “yes” answer favors a modular design effort.)

1. Can the design effort be simplified by using previously developed standard “building blocks”? (Assume that the reliability and input-output characteristics are consistent with the new system.)
2. Can deployed equipment be upgraded with newer and better functional units that replace older assemblies of component parts?
3. Does modular design take advantage of automated manufacturing methods?
4. Could the module be procured commercially?
5. Does modularity provide a more effective distribution of effort among the maintenance echelons?
6. Are recognition, isolation, and replacement of faulty units facilitated by modularization—which results in an increase in operational readiness?
7. Will modular design ease the problem of training maintenance personnel? Are fewer and less skilled maintenance personnel required?
8. Is the use of automatic diagnostics facilitated by modularization?

### 5-5.1.2 General Module Criteria

If a decision has been made to “go modular”, then the basic philosophy of the modular concept must be pursued providing a design that can be maintained at the least possible cost, with minimal downtime, and that will require lesser skills and less manpower at the unit level. The following guidelines apply:

1. Design equipment so that a maximum number of modules can be fault isolated by using the instrumentation provided as part of the equipment.
2. Provide the modules with as much self-fault testing and isolation capability as possible.
3. Install modules to be accessed, disconnected, and replaced and connected without special tools or handling equipment under ambient conditions.
4. Provide modules that require minimum post-maintenance servicing or calibration.
5. Provide module designs, i.e., encapsulation, that protect critical parts from environmental damage during storage and handling in forward areas.
6. Design modules to maximize the potential for discard-at-failure, rather than to repair, for all modules planned for replacement at the unit level.

### 5-5.1.3 Throwaway (Discard-at-Failure) Criteria

Throwaway (disposable) modules are easy solutions for difficult and potentially time-consuming maintenance problems. The advantages and hazards associated with throwaway modules are addressed in pars. 5-3.2 and 5-3.3, respectively.

Disposable modules should be designed, manufactured, and installed to meet the following criteria:

1. Expensive parts are not discarded because of failure of inexpensive parts.
2. Long-lived parts are not scrapped because of failure of short-lived parts.
3. Low-cost, noncritical, and generally available items are typically made disposable.
4. Disposable modules are encapsulated for protection and ease of handling but remain compatible with performance and reliability requirements.
5. Test procedures, to be applied before disposal, provide clear and unequivocal results.
6. Items are clearly marked for disposal at failure and so indicated in maintenance manuals and supply catalogs.
7. Discard instructions are documented in operator and maintenance manuals and in supply catalogs.
8. The precious metal parts of disposable modules are designed for ease of salvage.
9. Parts that can become contaminated are designated for proper protective measures.
10. Devices bearing a security classification are marked to provide the proper channels for disposal.

## 5-5.2 FUNCTIONAL GROUPING FOR MODULARIZATION

Functional relationships are used to facilitate fault isolation and to provide repair parts that are compatible with the logistical support plan. The conscious effort to locate and package components in self-contained functional units facilitates both the operation and maintenance of a system (Ref. 2). Techniques employed to achieve a functional relationship are

1. Logical flow grouping
2. Circuit grouping
3. Component grouping
4. Standard construction
5. Frequency grouping.

Each of these techniques is discussed in the paragraphs that follow.

### 5-5.2.1 Logical Flow Grouping

Logical flow, as its name implies, is the technique of grouping components of the overall system to parallel the inputs of individual assemblies or subassemblies as they functionally relate to the overall system. For example, the logical grouping for an automotive vehicle would be

power plant, transmission, and power train---the direction of the impetus (power) is from the engine to the power train, not the reverse.

Guidelines to be followed are

1. Package and locate components parallel to their functional relationships as established by a flow chart. Fig. 5-1 illustrates this idea.

2. Select methods and subassemblies so that only a single input check and single output check are required to isolate a fault within an item.

### 5-5.2.2 Circuit Grouping

Circuit grouping is the technique of grouping circuits—electric, hydraulic, or power—for a specific function, e.g., the audio and video circuits of television receivers and recorders. Guidelines to be followed are

1. Locate all parts of a given circuit or logically related group of parts—e.g., an automotive transmission— - together in a common volume.

2. Place each circuit within the group in a separate module, e.g., a printed circuit board of the plug-in type that can easily be replaced.

### 5-5.2.3 Component Grouping

Component grouping is the technique of grouping together components with similar functions or that possess common characteristics. Guidelines to be followed are

1. Locate items together that perform similar functions—e.g., amplification circuits, fuses, and relays.

2. Segregate resistors, capacitors, and transistors into a minimum number of different locations on subassemblies and terminal boards.

3. Group inexpensive components on a single chassis to facilitate throwaway at failure.

4. Group gages and instrument readouts—necessary for the control or monitoring of a function—into an instrument panel to facilitate operator surveillance.

5. Segregate components on the basis of significant

variations in the required maintenance tasks. For example, items that are to be cleaned by different methods—steam or solvent—should be packaged so that cleaning is possible with minimum masking.

### 5-5.2.4 Standard Construction

Standard construction is a technique that follows no preconceived set of rules. This construction creates a final product by balancing a number of factors—heat loss, component size, final unit size and weight, and eye appeal—to arrive at a compromise, which varies for each application of the standard item. Examples of such a compromise are the simple radio receivers available on the civilian market—they are configured in headsets, hand-held portable radios, clock radios, etc., for consumer appeal.

### 5-5.2.5 Frequency Grouping

Frequency grouping is the technique of grouping multiple, similar parts that are likely to require replacement at the same time. This technique is most beneficial if the dominant failure mode is wear, fatigue, or a similar age-dependent mode. Periodic replacement of assemblies because of anticipated failure makes possible a system that is, for all purposes, rebuilt.

### 5-5.2.6 Evaluation of Grouping Methods

An empirical evaluation of the previously described equipment grouping techniques was performed by technicians of different skill levels on a simple system and a complex system (Ref. 3). Based on the performance data used to make the evaluation—troubleshooting time, amount of information gained per unit of time, technician's subjective performance, and engineering criteria—it was determined that the logical flow method is superior to the standard construction method because the logical flow method clearly enhanced the ease of equipment maintenance. The other grouping techniques also were preferred to the standard construction method; however,

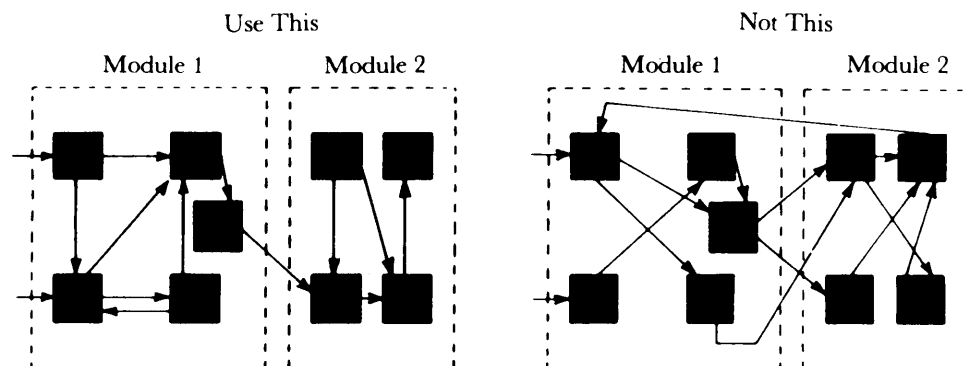


Figure 5-1. Design for Functional Utilization That Corresponds to Modularization

## DOD-HDBK-791(AM)

their superiority was not as clearly demonstrated as that of the logical flow method.

The selection process is not mutually exclusive however; choosing one particular method does not exclude the subsequent use of another method as the system evolves e.g., the logical flow method having been decided upon as the principal technique, circuit grouping could be used to augment the grouping technique.

### 5-5.3 TYPICAL DESIGN GUIDELINES

The following are typical design guidelines relative to modularization that will facilitate maintenance:

1. Make modules and component parts approximately uniform in basic size and shape for best packaging.
2. Minimize interconnections between neighboring modules.
3. Emphasize modularization for unit level replacement to enhance the operational capability. Modularization versus part replacement for intermediate and depot maintenance can be largely determined by cost factors.
4. Standardize modules and receptacles; however, particular care must be taken to prevent inadvertent plugging into the wrong receptacle.
5. Use guide pins for plug-in modules to permit error-free insertion.
6. Use quick-disconnect hold-down devices to permit easy removal.
7. Design all repairable modules so that the rapid, easy removal and replacement of malfunctioning parts within the module can be accomplished by intermediate and depot level maintenance technicians.
8. Divide equipment into as many units as are electrically and mechanically practicable while considering the efficient use of space.
9. Use an integrated approach i.e., simultaneously consider materials, design, and application to achieve cost-effectiveness.
10. Optimize the components of a module for a given single function rather than for multiple, divergent functions—many compromises may be necessary to accommodate multifunction units, which will render the module less than optimum and will defeat the purpose of modularization.
11. Design electronic modular units—if indicated to be in an unserviceable condition by built-in test equipment (BITE) or monitor to permit operational testing when removed. The immaturity or unreliability of the BITE may have resulted in a false alarm. This is particularly important if the module is expensive.
12. Match the physical separation of equipment into replaceable units with the functional design of the equipment. This will maximize the functional independence of units and minimize interaction between units.
13. If a major assembly can be made of two or more subassemblies, design the major assembly so that a sub-

sembly can be removed independently, i.e., without removal of the other subassemblies. This unitization is especially valuable when the subassemblies have varying life expectancies.

14. Unless it is structurally infeasible, design all equipment so that rapid, easy removal and replacement of malfunctioning components can be accomplished by one technician.

15. Where possible, make modules small and light enough for one person to handle and carry. Removable units should have a mass less than 18 kg (40lb). Units with a mass greater than 4.5 kg (10 lb) should have handles.

16. Consider part weight and size of a module in relation to its installed location to assure that handling loads are compatible with both male and female maintenance personnel, i.e., from the 5th percentile female to the 90th percentile male.

17. Where possible, make each module capable of being checked independently. If adjustment is required, design so that each module may be adjusted independently of other units.

18. Design control levers and linkages so they can be easily disconnected from components to facilitate module removal and replacement.

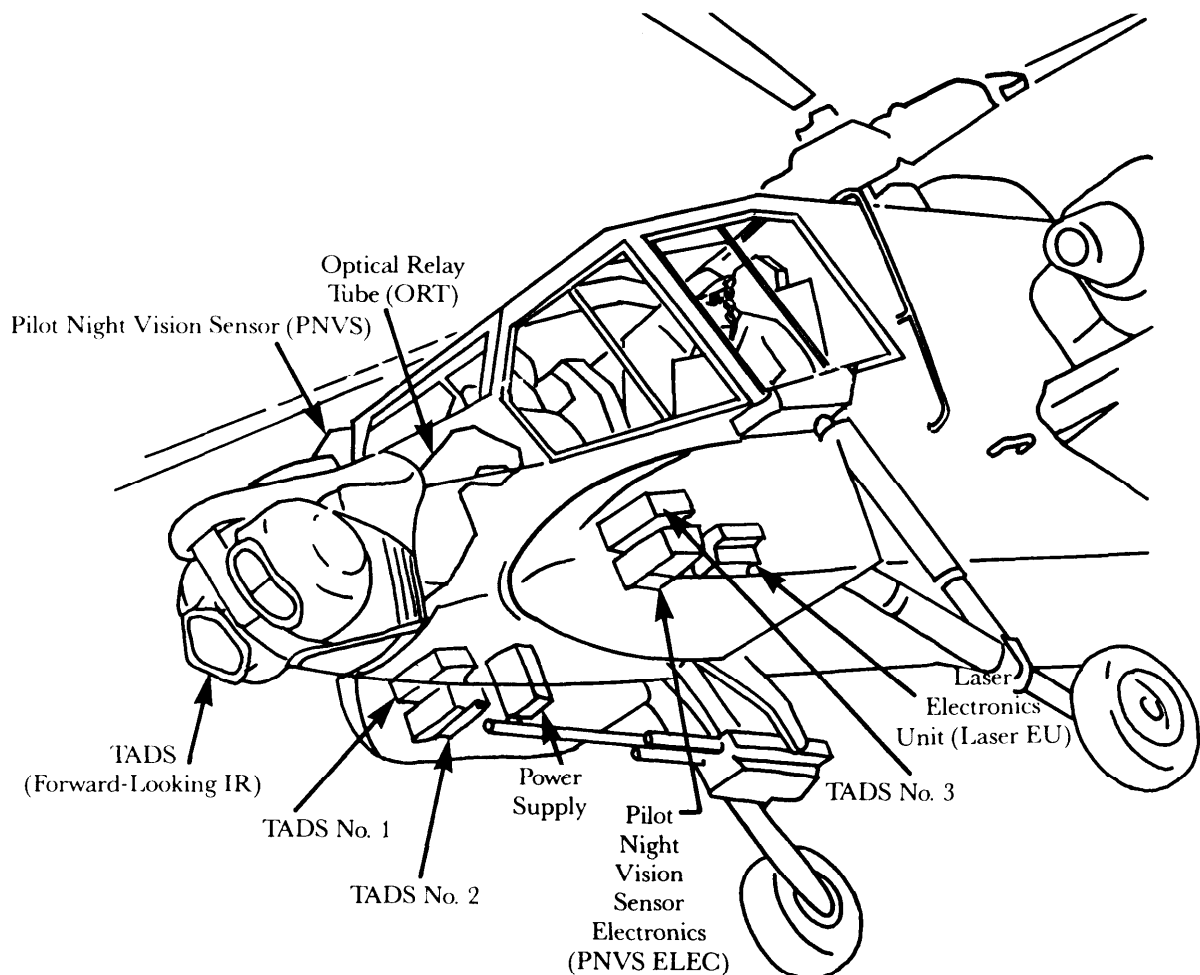
## 5-6 EXAMPLES

Typical examples of good modularization techniques will be presented for five areas, namely,

1. Electronic and electrical equipment
2. Sectionalization of missiles and rockets
3. Tank-automotive equipment
4. Modularization in armament
5. Helicopter engine.

### 5-6.1 ELECTRONIC AND ELECTRICAL EQUIPMENT

Logical flow and circuit packaging are both logic oriented: however, circuit packaging usually is on a level below that of logic flow because, as indicated in par. 5-5.2.6, the selection of one technique does not exclude the use of other grouping techniques at subordinate levels. Consider, for example, the Army's Target Acquisition and Designation System (TADS) (Ref. 4), which features the power supply as a black box (module); one of the power supplies for the four TADSS is shown in Fig. 5-2. In contrast, the stabilizing control system on the Army's Advanced Attack Helicopter (AAH) features the power supply as a component circuit board within a black box (module). In both cases the black boxes are modules based on the logic that supplying power is the first logical function and, at the unit level, they represent identical maintenance actions—i.e., replace when unserviceable. However, the AAH black box which is designed for maintenance at the intermediate or depot level—uses the



**Figure 5-2. Modules in Target Acquisition and Designation System (TADS)**

circuit grouping technique for the power component contained within the black box. Some other modules comprising the TADS are illustrated in Fig. 5-3.

Component grouping might subsequently be employed to segregate similar parts into modules. For example, all relays could be located on one card within a black box. Army missiles often have their gyroscopes segregated by a packaging technique, i.e., a packaged component as a module, because gyroscopes frequently fail if left dormant in storage (Ref. 5).

The Navy has established an extensive program referred to as the "Navy Standard Electronic Module Program" (SEM) (Ref. 6). The SEM (Ref. 6) is based on the principle of limiting redundant design through the use of standard functions, which achieves cost benefits through large production volumes and wide competition. The basic objectives of SEM are

1. To partition electronic functions so that they are common to a majority of equipment applications
2. To document modules that have functional specifications (to preclude dependence upon a specific vendor,

design, or technology). This results in long-term availability and cost savings through vendor innovation and competition.

3. To achieve high reliability through stringent quality assurance requirements for module design and production.

4. To discard modules upon failure; this is made possible by high reliability and low cost.

5. To provide flexible, modular, mechanical packaging requirements that employ various circuit and packaging technologies, and adapt to the various mechanical configurations of the equipment.

6. To ease the logistic support burden on the congested supply system by extensive intersystem commonality of a limited number of modules.

The Air Force has investigated the benefits that could accrue to their programs through the SEM approach (Ref. 7). Results indicated that the application of SEM concepts to simulation equipment could prove beneficial. For small and medium production quantities of single types of simulators, the SEM version had the lowest life

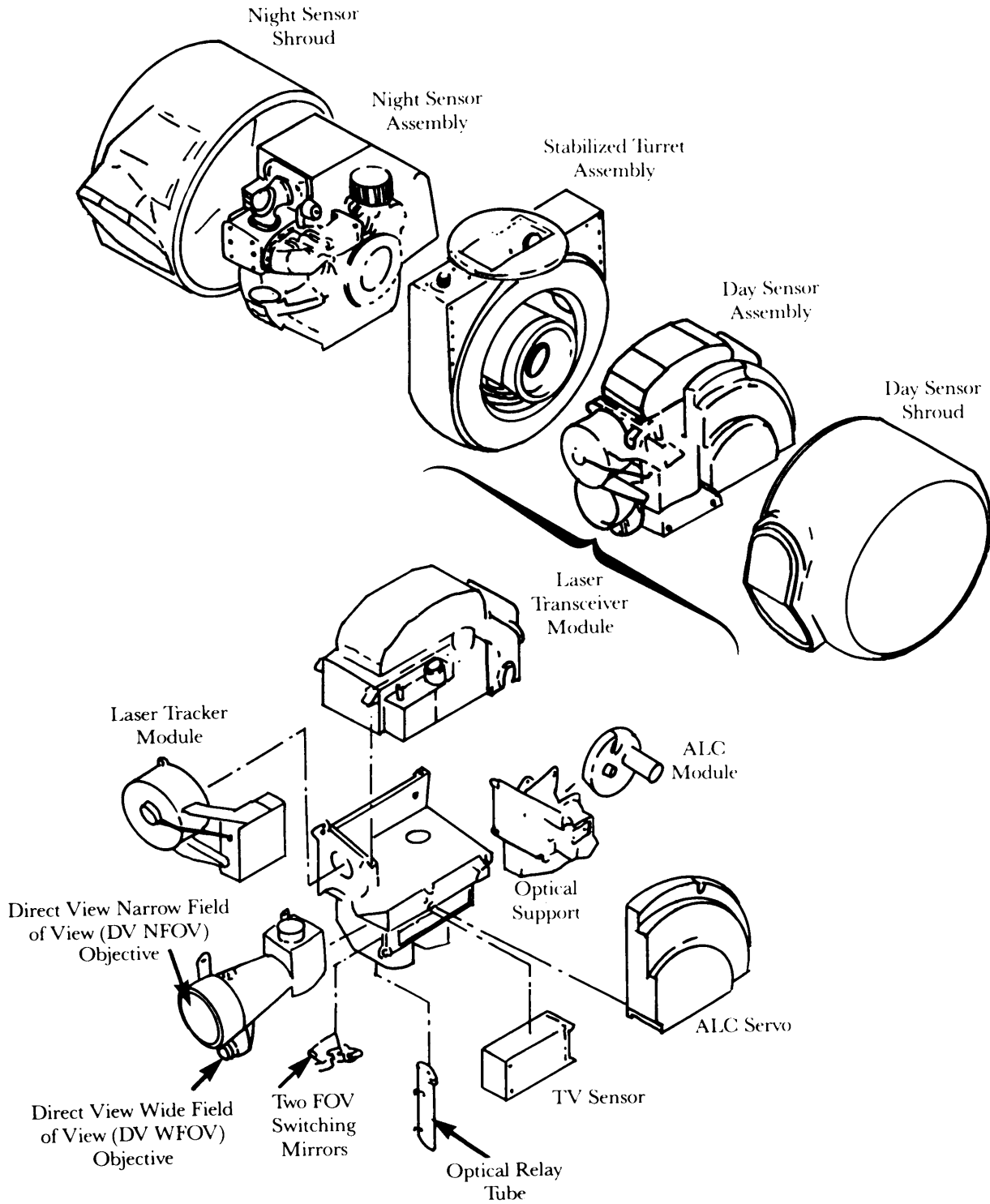


Figure 5-3. TADS Turret Assembly—Day Side Modules

cycle cost.

Although the SEM has been applied to the Navy's electronic equipment, the circuit modules could be applied advantageously to new Army equipment design. This would provide initial cost savings and possible improvement in the availability of repair parts for the North Atlantic Treaty Organization.

SEM documentation can be found in

1. MIL-STD-1378, *Requirements for Employing Standard Electronic Modules*
2. MIL-STD-1389, *Design Requirements for Standard Electronic Modules*
3. Navy Pub 0101-073, *Module Design Handbook*
4. Navy Pub 0101-051, *Program Manager's Handbook*.

## 5-6.2 MISSILES AND ROCKETS

To facilitate the handling, transportation, and storage, large missiles and rockets should be divided into functionally packaged modules or sections i.e., warhead, adaption kit, guidance, and motor—that are adaptable to rapid field assembly. This division allows for the separation of the explosive or other hazardous materials from inert components.

The Army's HELLFIRE missile system contains a modular guidance package that permits the missile to be used in three different modes. Although this is not modularization primarily for ease of maintenance, the HELLFIRE demonstrates the application of modularization of a component to permit the use of the basic system in different operational modes.

## 5-6.3 TANK-AUTOMOTIVE EQUIPMENT

Modularization as it applies to the tank-automotive area is already well-developed and present in vehicles. Consider the ancillary equipment related to the engine—plug, distributor, wiring harness, alternator, starter, oil filter, etc. which are good examples of modularization. Room for improvement exists. Examples of fuel injection, cylinder packages, and total vehicle modularization—discussed in the paragraphs that follow are examples of how the design can be improved to facilitate maintenance.

### 5-6.3.1 Fuel Injection

In many diesel engines the fuel injection pump can be factory timed and calibrated; thus it requires no adjustments when replacing an unserviceable system. The fuel injection system can be simply removed and replaced as a self-contained module and, when installed, is ready for operation. Other assemblies that lend themselves to this kind of no-calibration or -adjustment are prime candidates for exploitation.

### 5-6.3.2 Engine Modules

Fig. 5-4 shows the three major modules—gearbox,

forward engine, and rear engine—of the M1 turbine tank engine. Each module is a packaged assembly ready for installation. These modules significantly reduce the overhaul time previously required to disassemble, clean, inspect, recondition, and reinstall individual components. Special fittings and rigging are provided to remove the modules from their shipping containers for assembly into the tank as illustrated for the rear engine module in Fig. 5-5.

### 5-6.3.3 Total Vehicle

A study was undertaken to determine whether a concept of modular design for an automotive vehicle would effect a significant reduction in the maintenance load and improve the strategic posture of the field Army (Ref. 3). The significant results of this study indicated

1. Maintenance man-hours reduced 27%
2. Active maintenance downtime reduced 25%
3. Ratio of inactive to active downtime reduced 44%
4. Unavailability of trucks reduced 54%.

The modular units designed for quick disconnect and ease of replacement were

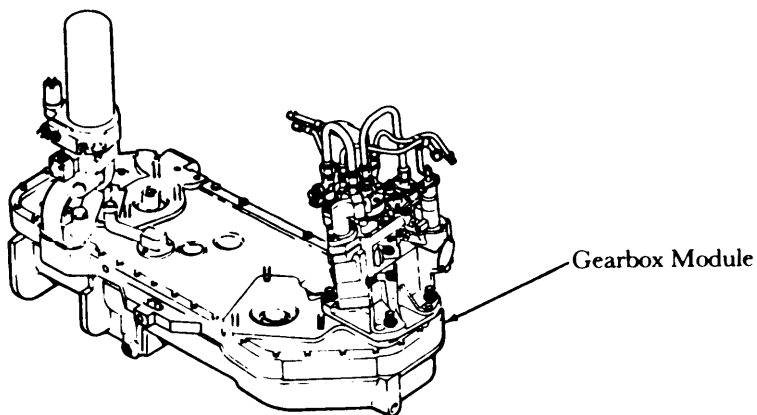
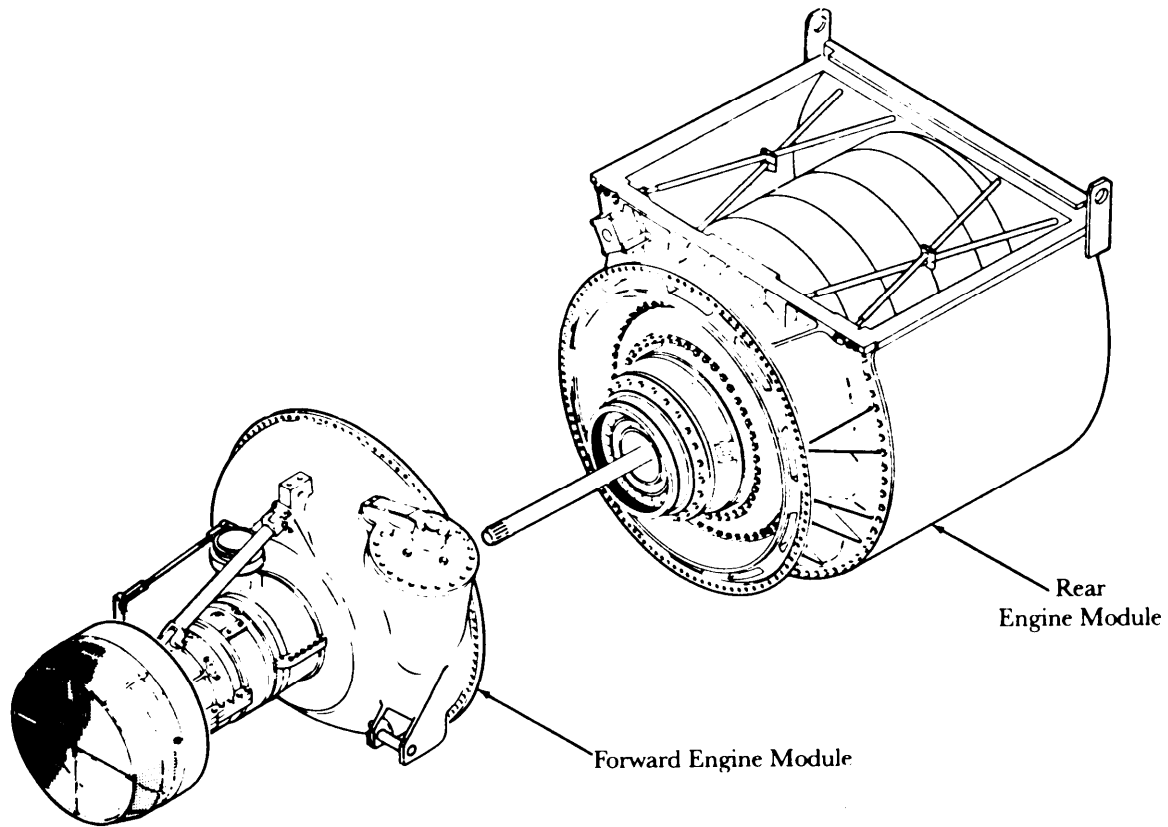
1. Engine Assembly. (See 1, Fig. 5-6.) Quick-disconnect fuel line, ignition wiring, starter cable, generator cable, and throttle controls
2. Transmission. (See 2, Fig. 5-6.) Quick-disconnect controls, features to permit ease of separation from engine by rail guides or lifting device
3. Transfer Assembly. (See 3, Fig. 5-6.)
4. Differential and Axle Assembly. (See 4, Fig. 5-6.)
5. Propeller Shaft Assemblies. (See 5 and 6, Fig. 5-6.)
6. Rear Wheels (Hub and Brake) With Tires. (See 7, Fig. 5-6.) Quick disconnect on brakes
7. Front Wheels (Hub and Brake) With Tires. (See 7, Fig. 5-6.) Quick disconnect on brakes
8. Steering Gear Assembly. Quick disconnect.

Real data on fielded trucks were used in a Monte Carlo simulation to compare parameters of a standard vehicle to a modular vehicle. Fig. 5-7 summarizes the results, which indicate

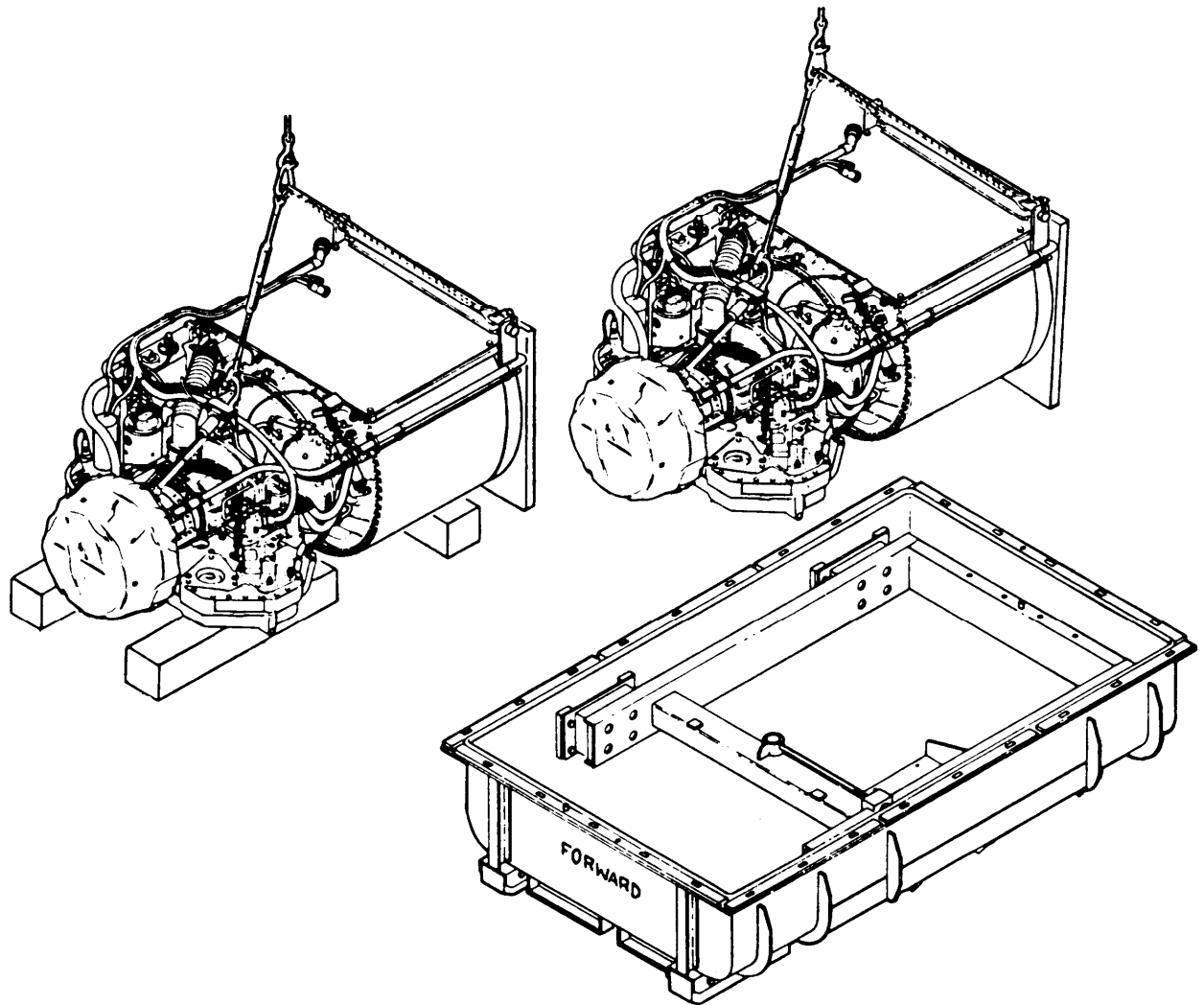
1. Reduction in occupational specialists
2. Considerable savings in training costs
3. Substantial savings in special tools and test equipment
4. Improvement in the availability status.

## 5-6.4 MODULARIZATION IN ARMAMENT

This subparagraph describes examples of modularization in armament equipment, e.g., small arms and cannons. The first example is the modularization of a functional group in a gun; the second example is the modularization of a complete gun.



**Figure 5-4. M1 Turbine Engine Modules for Tank**



**Figure 5-5. Fittings and Rigging for Rear Engine**

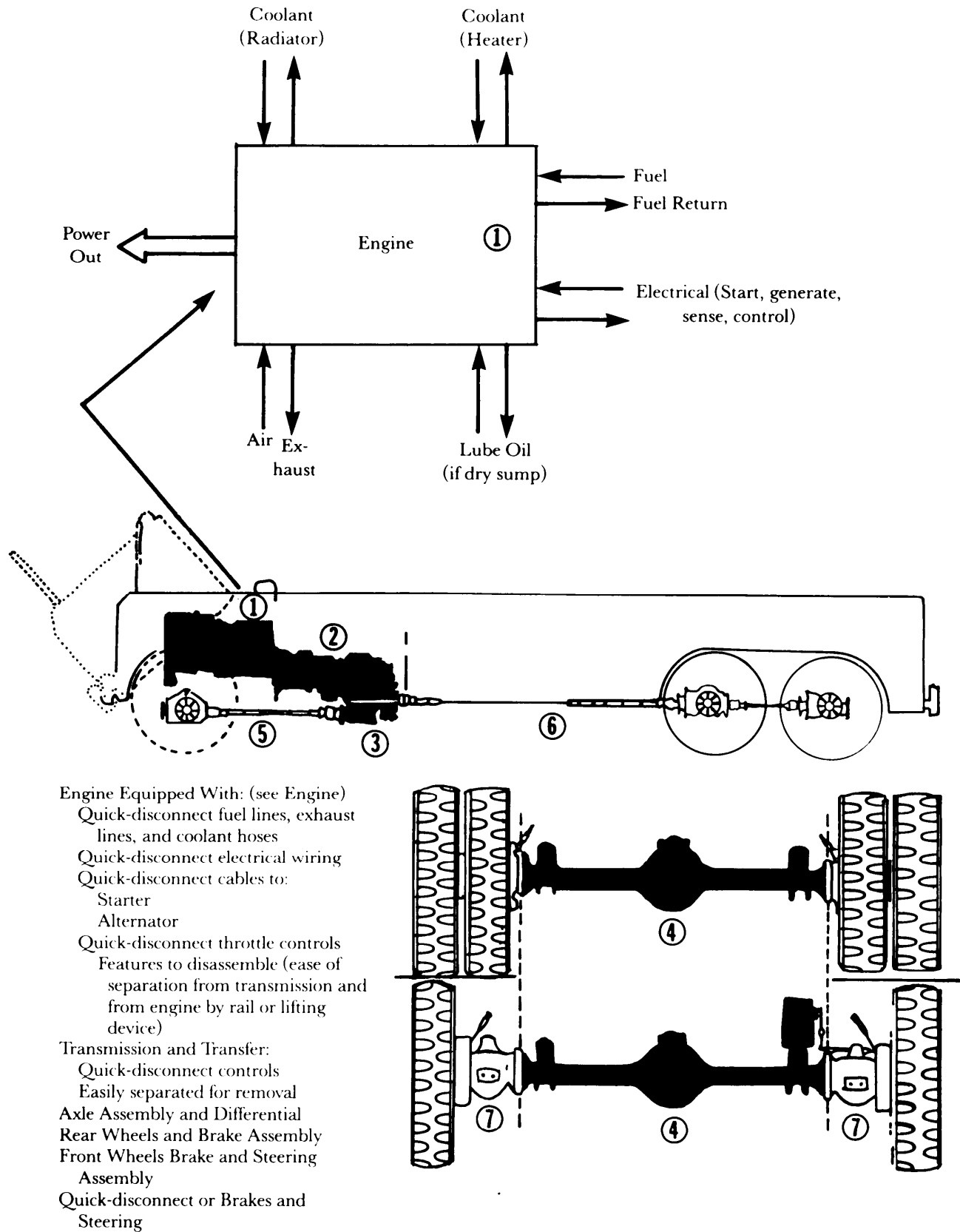


Figure 5-6. Modular Vehicle Design

<u>Consideration</u>	Standard Vehicle	Modular Vehicle
<u>PERSONNEL</u>		
Man-Hours (active maintenance)	8680	6227
Man-Years	4.34	3.113
Manpower Utilization (average)	(Undetermined)	12.5%
<u>TRAINING</u>		
Number of Military Occupational Specialty (MOS) Types Involved	3	1
Training Cost per MOS	\$ 5626.00 (2 types)	0
Total Training Cost	\$22,504.00	0
<u>TOOLS AND TEST EQUIPMENT</u>		
Special Tools, Kits, Test Equipment	\$2143.42	0
<u>REPAIR PARTS</u>		
Number of Federal Stock Numbers (FSNS) Involved	1260	277 (est)
Unit		
No. of Type Items Stocked	(Unknown)	28 (est)
Quantity of Items Used	1130	1088
Intermediate		
No. of Type Items Stocked	(Unknown)	249 (est)
Quantity of Items Used	2350	2265
<u>AVAILABILITY</u>		
Active Maintenance Downtime	8335	6257
Inactive Maintenance Downtime	47,510 (est) (per fleet per year)	20,223 (per fleet per year)

Figure 5-7. Data Output Balance Sheet

#### 5-6.4.1 Feed and Eject Module

CHAIN GUNS® are externally powered guns, in which the ammunition feed is powered by an electric motor rather than by gas from a fired projectile (Ref. 8). Fig. 5-8 shows the bolt assembly and drive train modules within the CHAIN GUN. Failure in any of the parts of the chain drive module requires only removal and replacement of the module.

#### 5-6.4.2 Complete Gun Modularization

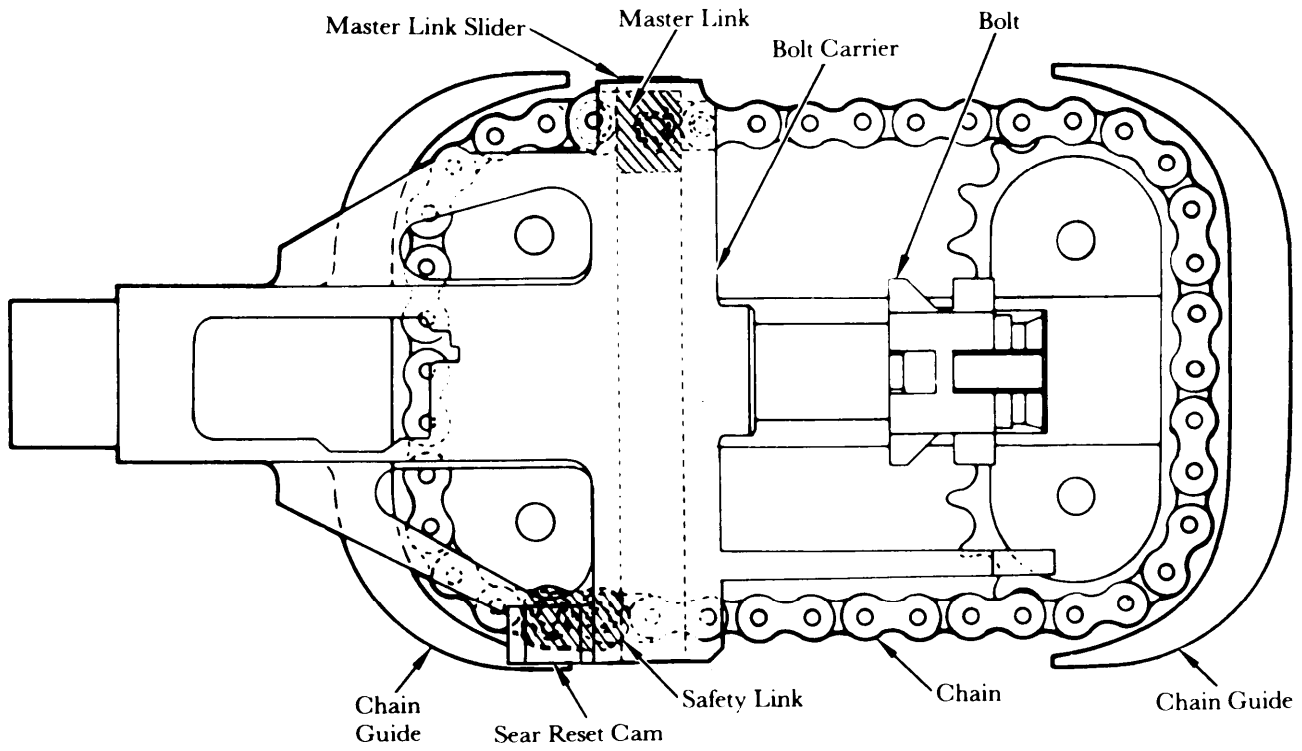
Fig. 5-9 shows the assembled 5.56-mm M231 Submachine Gun. Its modularization has resulted in simplification, reduced weight, improved maintainability, and potentially decreased production costs. Fig. 5-10 illustrates the modular assemblies. The barrel assembly is designed for quick change. These five modular units—except for removal of the barrel from the upper assembly—cannot be reduced further to the usual array of unmanageable piece parts associated with earlier submachine gun models. The weapon can be disassembled in approxi-

mately 10s without special tools. Compared to previously fielded standard submachine guns, the five modular components represent a major reduction in parts.

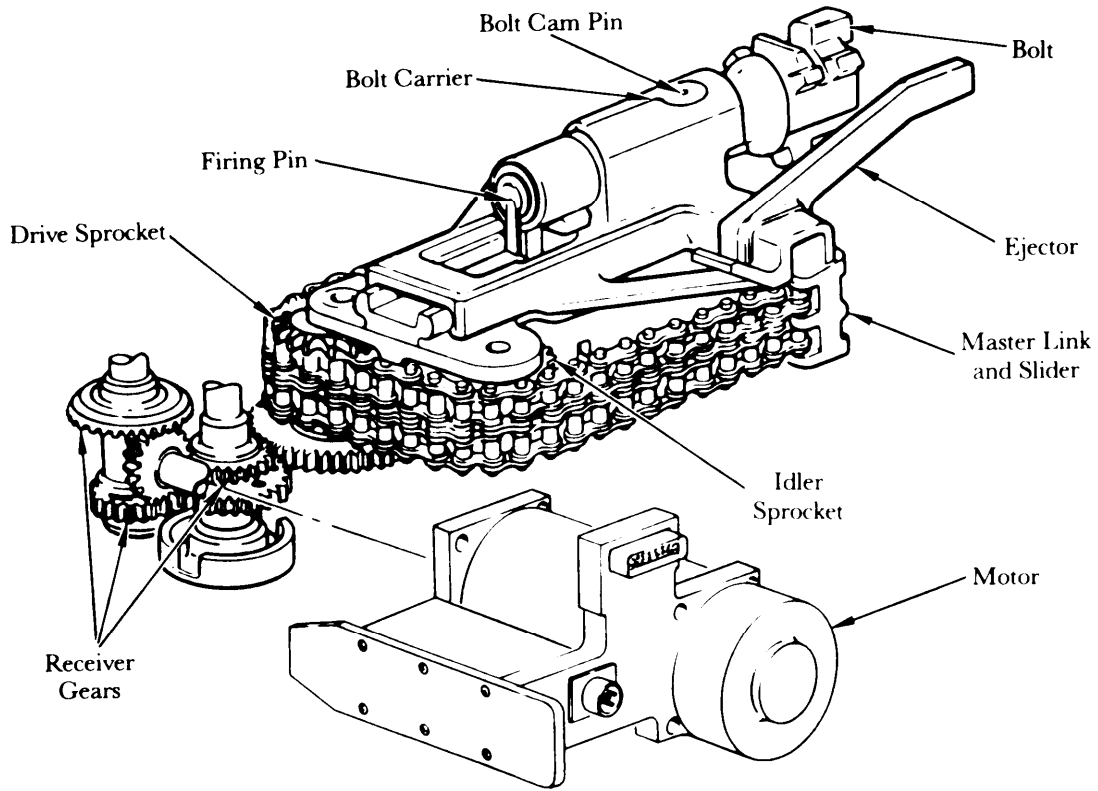
#### 5-6.5 HELICOPTER ENGINE

The complete Lycoming T-53 gas turbine engine is built of many subassemblies that can be exchanged as complete modules (Ref. 9). In case of extensive damage within one subassembly, the engine can be made operable again in a short time by exchanging an entire module. Also it is possible to replace the combustor assembly, the main reduction gear, the fuel control, and other accessory modules. The axial compressor housing is split lengthwise so that compressor vanes or blades can be replaced.

The design of the T-53 permits removal of the entire combustor assembly, which contains the power turbine within the exhaust diffuser, by simply unbolting at the combustion chamber flange—an operation accomplished without removing the engine from its mounting in the airframe. In this way all hot end parts—turbine blades,



(A) Schematic View of Chain Drive



(B) Exploded View of Bolt Assembly and Chain Drive

**Figure 5-8. CHAIN GUN<sup>®</sup> Bolt Assembly and Drive Train Modules**

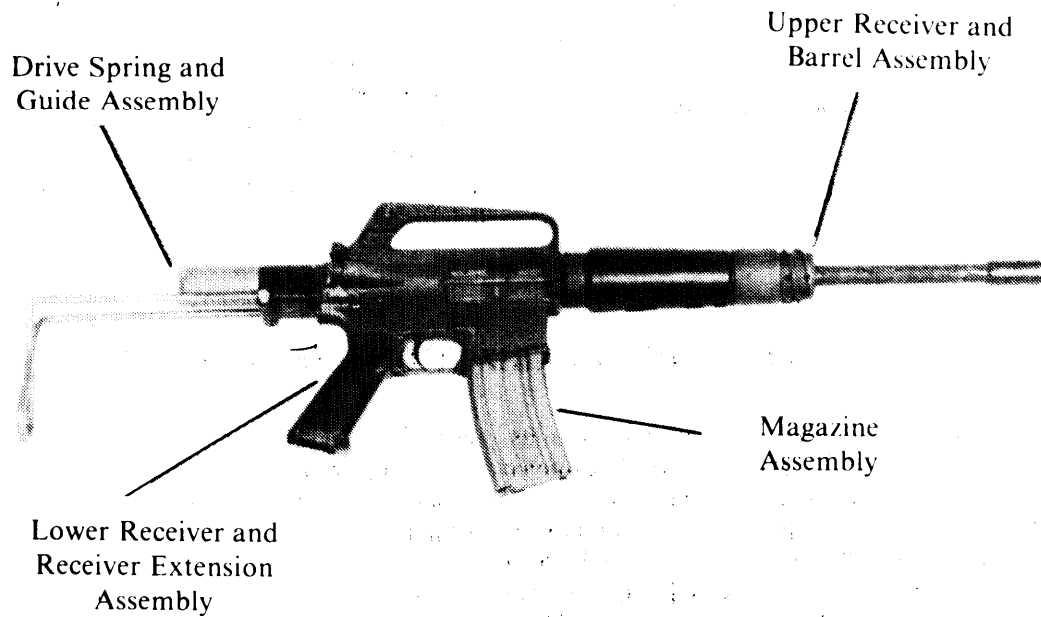


Figure 5-9. 5.56-mm M231 Submachine Gun

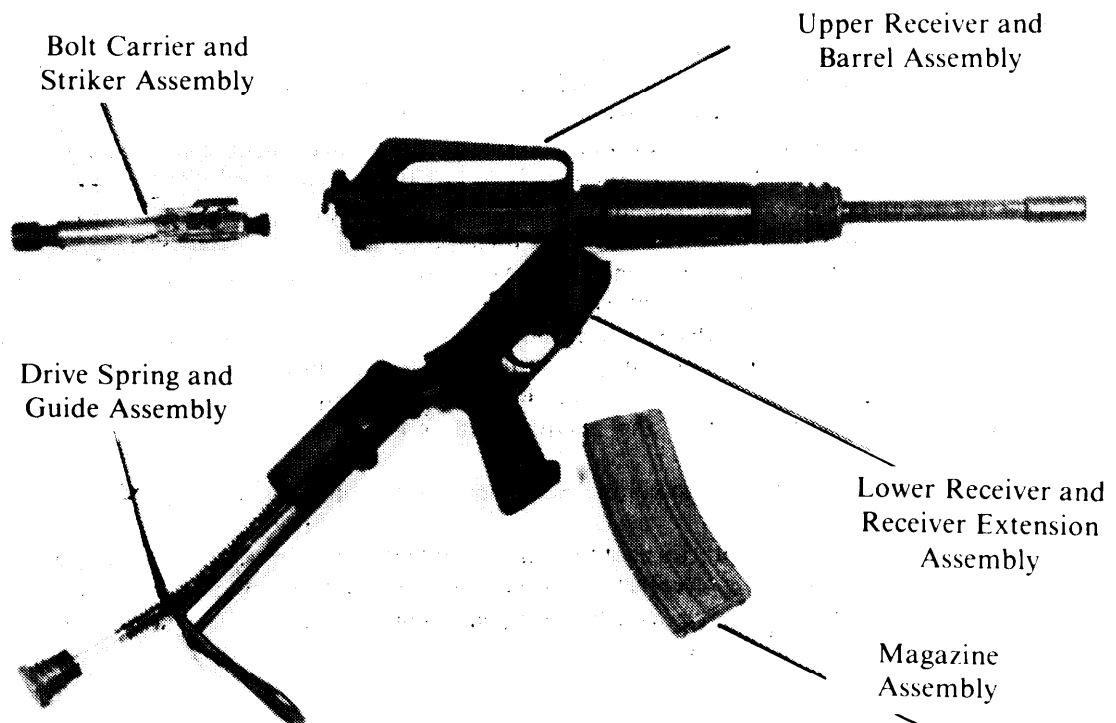


Figure 5-10. Modules for 5.56-mm M231 Submachine Gun

fuel vaporizing tubes, nozzles, rotors, combustion chamber liner, etc.—can be replaced or inspected. In one case the “hot end” inspection was carried out during field maneuvers. An inspection revealed a defective oil seal. The inspection was completed, the seal replaced, and the aircraft made ready for operation in less than 4 h.

## 5-7 MODULARIZATION CHECKLIST

Table 5-1 summarizes the important design recommendations to be considered when designing for modularization. The checklist contains several items that were not discussed in the text. They are included because their necessity in the design is so obvious they might otherwise be overlooked. In using the checklist, if the answer to any question is “no”, the design should be reexamined to determine the need for correction.

**TABLE 5-1. MODULARIZATION CHECKLIST**

### A. GENERAL

1. Is the equipment divided into as many modular units—mechanical, electrical, electronic—as practical in keeping with the effective use of space and overall equipment availability requirements?
2. If all components of a module except one or two are extremely reliable, has consideration been given to unitizing the module with the unreliable components removable from the exterior of the package? Has consideration been given to improving the reliability of the unreliable items?
3. Has an integrated approach—considering simultaneously the problem of materials, component design, and application of the modular concept—been used?
4. Are modules and component parts approximately uniform in basic size and shape for best packaging when feasible?
5. Do the modular units contain components that are optimized for a given function rather than providing multiple, divergent functions?
6. Do the modular units permit reliable operational testing when removed from the equipment and require little or no adjustment after replacement?
7. Does the physical separation of equipment into replaceable modules match the functional design of the equipment?
8. Where an assembly can be made up of two or more module subassemblies, does the major assembly consist of modules that can be removed or serviced independently without removal of the other modules? NOTE: This is particularly important when the modules have widely varying life expectancies.
9. Have modules been designed so that the rapid and easy removal and replacement of malfunctioning units can be accomplished by one technician unless it is structurally or functionally not feasible?
10. Where possible are units small and light enough for one person to handle and carry? Do units have a mass less than 18 kg (40 lb)? Do units that have a mass greater than 4.5 kg (10 lb) have handles?
11. Is each module capable of being checked independently? If adjustment is required, is the module designed so that it can be adjusted independently of other units?
12. Has the modular concept for major subsystems and components of vehicles—to permit replacement as a unit or being repaired or tested outside the vehicle or parent item—been considered?
13. Have control levers and linkages, and other hookups been designed so that they can easily be disconnected, and easily and correctly reconnected, from the modules and thus enhance the modular concept of ease of maintenance?
14. Has modularization been emphasized to permit maintenance at the operational (unit) level to enhance operational availability?
15. Are standardized modules and receptacles used to facilitate replacement? Is particular care exercised to prevent inadvertent plugging into the wrong receptacle? Has receptacle coding by shape, size, or color been employed?
16. Are quick-disconnect holddown devices used to permit easy removal and replacement of module?

TABLE 5-1 (cont'd)

## B. THROWAWAY DESIGN

1. Does the failure of inexpensive parts result in the disposal of an expensive module?\*
2. Does the failure of short-lived parts result in the disposal of long-lived parts?\*
3. Are low cost and noncritical items made disposable?
4. Are all encapsulated modules designed for disposal at failure? If not, has the module been designed to permit access for repair at intermediate or depot level?
5. Is the maintenance level and or criteria, i.e., time to repair and, or cost of module- clearly specified?
6. If test procedures are to be applied before disposal, are they clearly specified, and do they provide clear and unequivocal results?
7. Does the module identification plate or marking contain the statement "Dispose at Failure"? Do the repair manuals and supply catalogs so indicate?
8. If the module contains precious metals that should be recovered, is the module designed for ease of salvage of these components? Is module labeled to indicate that it has salvageable components? Do manuals so indicate?
9. If module contains contaminants, is it so labeled and instructions provided in pertinent manuals for its disposal?
10. Are modules bearing a security classification properly labeled, and are instructions provided in pertinent manuals for their disposal?

\*A yes answer to these questions indicates a need to reexamine the design for corection.

## REFERENCES

1. Robert H. Dunn and Richard S. Ullman, *Modularity Is Not a Matter of Size*, 1979 Proceedings of Annual Reliability and Maintainability Symposium, 23-25 January 1979, p. 342.
2. AMCP 706-133, *Engineering Design Handbook, Maintainability Engineering Theory and Practice*, January 1976.
3. R. I. Moeller and R. E. Redfern, *Materiel Support System Model-Automotive*, Annals of Reliability and Maintainability, Fourth Annual Reliability and Maintainability Conference, 28-30 July 1965, p. 481,
4. B. J. Baskett, C. M. Tsoubanos, V. M. Weiner, "The TADS/PNVS 'Eyes' for the AH-64 Attack Helicopter", *Vertiflite*, American Helicopter Society, November December 1980.
5. *Storage Reliability of Missile Material Program*, US Army Missile Command, Huntsville, AL, June 1974.
6. NAVSEA Journal, September 1975, p. 28.
7. Robert Laskin and William L. Smithisler, *The Economics of Standard Electronic Packaging*, 1979 Proceedings of Annual Reliability and Maintainability Symposium, 23-25 January 1979, p. 69.
8. Brochure on 25-mm M242 Automatic Cannon, Ordnance Marketing, Hughes Helicopter. Subsidiary of McDonnell-Douglas, Culver City, CA.
9. Stanley Duhan, *Maintainability at Work—The T-53 Gas Turbine Engine*, Annals of Reliability and Maintainability, Fourth Annual Reliability and Maintainability Conference. 28-30 July 1965, p. 501.

## BIBLIOGRAPHY

- Lyle R. Greenman, *Is Maintainability Keeping Up With Electronics?*, Proceedings of the 1976 Annual Reliability and Maintainability Symposium, 20-22 January 1976, p. 157.
- NAVORD OD 39223, *Maintainability Engineering Handbook*, 1 February 1970.

**This page intentionally left blank.**

## CHAPTER 6

# IDENTIFICATION AND LABELING

*This chapter emphasizes the importance of the proper identification of parts and the labeling of function to improve equipment maintainability. basic principles associated with labeling are discussed, and the subsequent presentations are devoted to the application of these principles. Methods of labeling, positioning, and label design to include letter fonts and sizes, colors, and color contrasts are presented. an identification checklist is provided.*

### 6-1 INTRODUCTION

There are four distinct aspects of identification and labeling, namely,

1. What marking is required or necessary?
2. What information should the marking contain?
3. How should the marking be applied?
4. Where should the marking be applied?

These four aspects are covered in detail in subsequent paragraphs.

Labels, legends, placards, signs, or markings should be provided wherever it is necessary for an operator or technician to identify, interpret, follow procedures, or avoid hazards in the use or maintenance of systems or equipment except where it is obvious to the observer what an item is and what to do about it. The proper identification and labeling of equipment components, parts, controls, instruments, and test points simplify the technician's task and reduce both the task time and risk of error. However, identification, when considered in isolation, does not constitute maintainability; the fact that an item is adequately labeled does not mean that it can be maintained.

Melvin S. Majesty (Ref. 1) states, "... analysis of 600 recent rocket engine Failure and Consumption Reports by Chase and Tobias ( Ref. 2) showed that 35% of the failure reports indicated equipment failure or malfunction directly attributable to human interaction with the equipment during maintenance." The study indicated that the error rate would have improved (1) by unambiguous identification of parts and equipment functioning, which would have minimized the need to reference repair manuals and other data sources. and (2) by properly labeled positions where equipment is installed. operating procedures. and operational limits.

Identification can be defined as the adequate marking or labeling of parts, components. controls. and test points to facilitate repair or replacement during maintenance operations (Ref. 1). Proper identification is present if the component is readily identified for repair, replacement, or service with minimum effort by the technician

Included in identification is the process of determining what markings are required to identify a part correctly or

to designate a function; it also determines the best method for accomplishing the process. Identification markings usually are identified with instruction plates, function or operation information, and caution or warning signs applied directly to the item. whereas labels are usually identified with the precise nomenclature or function of the item, or they are diagrammatic instructions for the operation or maintenance of the equipment. Labels frequently are used on the exterior of access locations to describe the equipment or components to be accessed, to help reduce access time, and to eliminate possible confusion during maintenance operations particularly if the opening provides access to several similar components. For example, a circuit diagram on the inside of an access cover can eliminate the need to obtain a manual, which simplifies the acquisition of necessary data during maintenance. Regardless of whether the identification is marking or labeling, the same guidelines apply.

Since materiel may be exported or integrated into the NATO forces, markings should conform to appropriate international specifications and labeling—i. e., size, color, symbols, and units of measure.

The information in this chapter relative to purpose, use, format, and size of labels and identification implements the general guidance expressed in pars. 9-3.1 and 9-4, Chapter 9, "Human Factors". Labeling and identification are not exact sciences; the guidance presented in this chapter and the referenced documents are the result of experience, observation, and lessons learned.

The referenced Military Standards and Military Specifications do not reveal the complete story with regard to labeling and identification, e.g.. MIL-STD-130 (Ref. 3) refers to many other specifications. To include additional specifications with each reference would be cumbersome and would clutter the text; accordingly, a bibliography has been included to augment the references. To gain a full appreciation of the art of labeling and identification, the reader is urged to refer to the references and bibliography in implementing the guidance contained in this chapter.

## **6-2 BASIC CHARACTERISTICS**

The characteristics of the label, legend, or marking should be determined by such factors as (Ref. 4)

1. Accuracy of identification required
2. Time available for recognition and other responses
3. Distance at which device must be read
4. Illumination level and color characteristics of the illumination

5. Criticality of the label, legend, or marking.

Labels and identification should conform to these principles (Ref. 4):

1. Labels should give the user the information required to assist in performance of the task.
2. Labels should be located consistently throughout the equipment.
3. Labels should use familiar words; avoid overly technical or difficult words.
4. Labels should be brief and unambiguous; omit punctuation.
5. Labels should be printed to read horizontally left to right, not vertically unless the device demands it.
6. Labels should be supplemented where necessary with other coding procedures such as color and shape.
7. Labels should be placed where they can be seen easily, not where other units in the assembly will obscure them.
8. Labels should be large enough so that the operators and technicians can read them easily at the normal working distance.
9. Generally, labels should be printed in capital letters; however, if a label has several long lines, use both upper- and lowercase letters.
10. Labels should be printed in boldfaced letters only for short words or phrases that require emphasis.
11. Labels should be placed on or very near the items they identify; eliminate confusion with any other items and labels.
12. Labels should be etched, molded, or embossed, where practical, into the surface for durability rather than stamped, printed, or stenciled. Decals are acceptable but less desirable.

Subsequent paragraphs will expound upon these characteristics and principles.

## **6-3 TYPES AND USES OF IDENTIFICATION**

### **6-3.1 GENERAL**

Various types of markings are used on equipment, parts, and diagrams to assist operators, technicians, and supply personnel. The purposes of these markings are to

1. Assign a unique nomenclature describing the item—name, model number, serial number for logistical and accountability controls. Definitions should be in accordance with MIL-STD-280 (Ref. 5).

2. Identify function.

3. Indicate operational and hookup or connection instructions to minimize error during operation and repair and to reduce the need to refer to manuals for critical information.

4. Indicate hazardous conditions.

The manner in which these purposes are implemented is presented in the paragraphs that follow.

### **6-3.2 EQUIPMENT IDENTIFICATION**

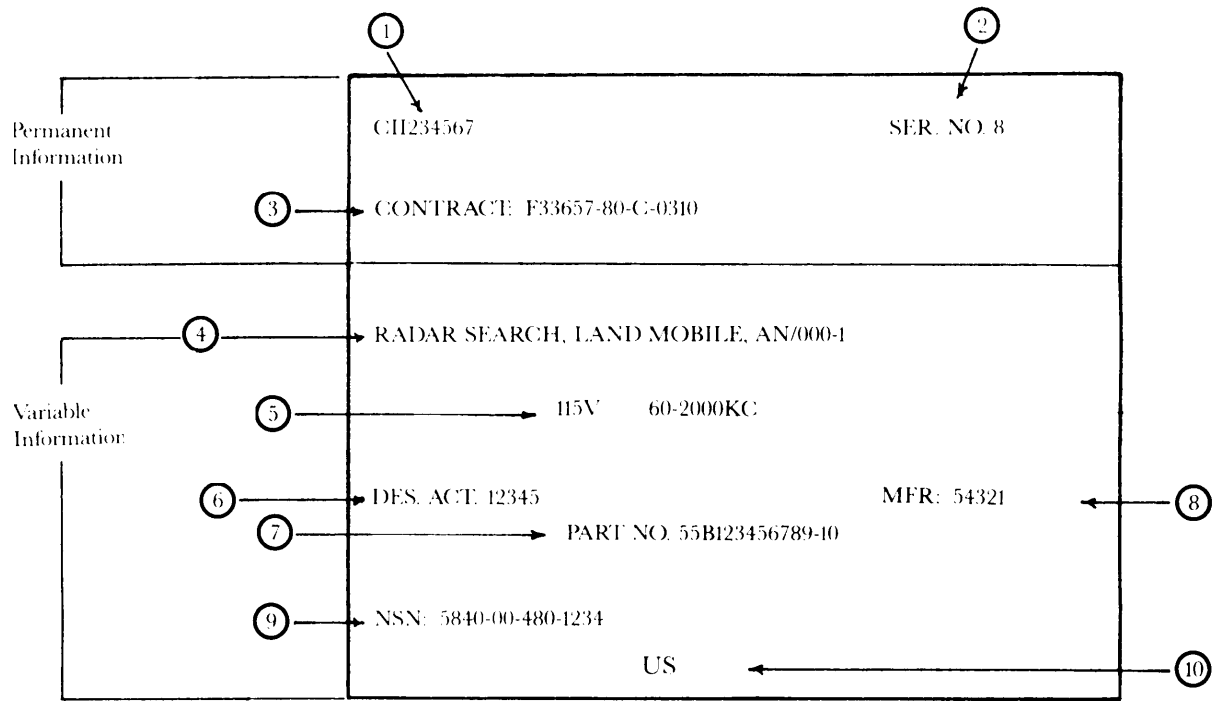
Equipment in this context, to distinguish it from minor subassemblies and or parts, refers to items issued for a specific tactical or administrative role e.g., a tank, truck, artillery piece, or radio. Major subsystems, e.g., laser range finder for a tank, would also qualify as equipment. (Part identification and marking are discussed in par. 6-3.5.) Equipment should be marked in accordance with MIL-STD-130 (Ref. 3) with a permanent identification e.g., stamping, engraving, molded in, attached plate, or decal. The identification label should be securely attached to the equipment and be resistant to water, oil, fuel, cleaning solvents, corrosion, and wear. The permanent plate should allow for a revision in model number when equipment has been retrofitted, e.g., 8-in. Gun, M101, to 8-in. Gun, 101A1.

Markings should contain the following information (Ref. 3):

1. Item nomenclature and type designation
2. Design activity Federal supply code for manufacturers (FSCM) or NATO supply code for manufacturers (NSCM)
3. Manufacturer's identification the manufacturer's name, FSCM, or NSCM, which identifies the place of manufacture
4. Procurement instrument contract or purchase order identification number
5. Serial number a unique notation that identifies its a single unit of a family of like units; normally assigned sequentially (set Ref. 5)
- \*6. US to denote Government ownership
- \*7. Special characteristics pertinent rating, operating characteristics, and other information necessary for identification of item
- \*8. NATO and national stock number (NSN)
- \*9. Configuration item identifier (CII) the number assigned to identify a configuration item. When assigned, it is the unchanging base number to which serial numbers are assigned.

The items marked with an asterisk (\*) are shown only when specified in the contract or purchase order. Fig. 6-1 is an example of an identification plate.

If the item is warranted by a contract Statement of Work or other contract clauses, the nature of the warranty should be conspicuously displayed by a label. Fig. 6-2 is an example of a warranty marking.



- (1) Configuration Item Identifier
- (2) Serial No.
- (3) Procurement Instrument Identification No.
- (4) Nomenclature (Item Name and Type Designation)
- (5) Special Characteristics
- (6) Design Activity (FSCM or NSCM)
- (7) Part No. or Identifying No.
- (8) Manufacturer (FSCM or NSCM)
- (9) National Stock No.
- (10) Government Ownership Designation

**ADDITIONAL INFORMATION.**

as applicable, may be integrated into the identification plate or may be applied adjacent to the major portion, whichever is most suitable.

Permanent information may be included on a plate separate from variable information plate.

NOTE: This example is given only as a guide and should not be considered a mandatory format.

**Figure 6-1. Example of Identification Plate (Ref. 3)**



- (1) Indicate expiration date.
- (2) Indicate condition of use—i.e., hours of operation, cycles of operation, time since manufacture.

**Figure 6-2. Example of Warranty Marking (Ref. 3)**

### 6-3.3 EQUIPMENT FUNCTIONAL AND/OR INSTRUCTIONAL MARKINGS

No specific guidelines or criteria exist for determining when to install functional and or instructional markings on equipment. Instruction plates are not required when the steps to be taken are obvious to the average mechanic. Conversely, instructions should be provided when it is determined that a technician trained on past equipment would have a high risk of error if he applied the same maintenance procedures to the new equipment. Accordingly, each equipment item should be evaluated carefully to determine what instructions are required and the proper content of these instructions. It is safer to overinstruct than to underinstruct. Basically, the decision involves the evaluation of the anticipated maintenance operation to determine what information the technician requires. For example, a simple operation such as changing a drive belt should be illustrated if the belt is crossed over. If reference to data can be eliminated by placing simple instructions on the equipment, an instruction plate or diagram is warranted. Areas that merit consideration are basic operating instructions; calibration data; simple wiring or fluid flow diagrams; adjustment instructions; location of test points; location of piece parts on electronic circuit cards; valve and ignition settings; types of fuel, oil, and lubricant to be used; and other data required to perform routine servicing and maintenance. Guidelines for the placement of instruction plates are provided in par. 6-5.2.

When considered important, the identification of pertinent data with regard to function, capacity, capabilities, limits, ranges, frequencies, voltage, current, power, revolutions per minute, weight, etc., should be indicated. The data may be displayed on a separate plate or integrated with the nomenclature plate as shown in Fig. 6-1. To be current on instruction plate identification, consult the latest revision of MIL-P-514 ( Ref. 6).

### 6-3.4 HAZARDOUS CONDITION MARKINGS

Hazards and associated risks should be eliminated by design wherever possible. Components should be located so that required access during operation, servicing, maintenance, or adjustment minimizes personnel exposure to hazards. When alternate design approaches cannot eliminate the hazard, only then should warning and caution labels be displayed (Ref. 7). The use of warning and caution markings should not be used as a substitute for proper engineering design.

Hardware, *per se*, is not the only source of hazards. An analysis of work areas and maintenance operations should be made by human factors personnel and industrial safety personnel to identify hazards that may result from unsafe acts by technicians and maybe introduced by

an equipment malfunction. These potential hazards should be identified.

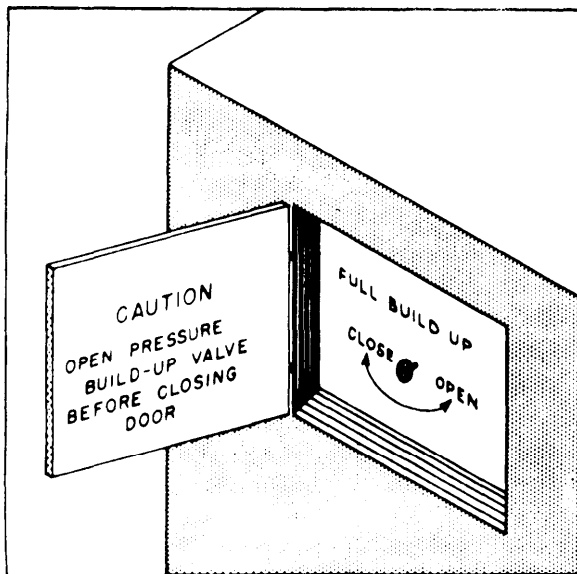
Guidance relative to the use of warning and caution signs is

1. Install appropriate labels to remind the technician that he must consult a technical manual before working on equipment.
2. Erect high visibility warnings if personnel may be subjected to harmful gases, noise levels, or sudden increases or decreases in pressure, laser beams, electromagnetic radiation, or nuclear radiation.
3. Identify areas of operation or maintenance in which special protective clothing, tools, or equipment e.g., insulated shoes, gloves, suits, hard hats, and or breathing masks are necessary.
4. Mark all electrical receptacles with their voltage, phase, and frequency characteristics, as appropriate; specific details are contained in MIL-STD-454 (Ref. 8).
5. For aircraft, missile, and space systems clearly and unambiguously label pipe, hose, and tubing for fluids (gas, steam, hydraulic fluids), and label or code them as to contents, pressure, heat, cold, or other hazardous properties in accordance with MIL-STD-1247 (Ref. 9). Mark and color code pipelines for other systems in accordance with MIL-STD-101 (Ref. 10).
6. Provide "NO STEP" markings where necessary to prevent injury to personnel or damage to equipment.
7. Labeljacking and hoisting points conspicuously and unambiguously, and describe any special handling requirements for these operations.
8. Distinctly mark the center of gravity and the weight of equipment where applicable.
9. Indicate weight capacity on stands, hoists, cranes, lifts, jacks, and similar weight-bearing equipment to prevent overloading.
10. Prominently display labels instructing the technician in hazardous situations, for example, instructions for sequential operations as shown in Fig. 6-3 (Ref. 11).
11. Make caution and warning signs as informative as possible, yet they should be consistent with limits on information required and space available (see Fig. 6-4). The content of the label will vary, but it should inform personnel
  - a. Why a hazardous condition exists
  - b. Places to avoid
  - c. Behavior to avoid
  - d. Sequence to follow to obviate a danger
  - e. Where to refer for additional specific information.

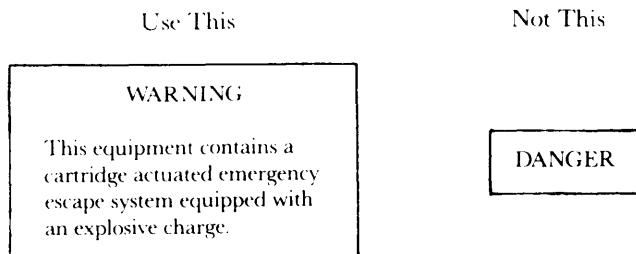
The language level of the signs should be consistent with the reading level of the target audience.

### 6-3.5 PART IDENTIFICATION

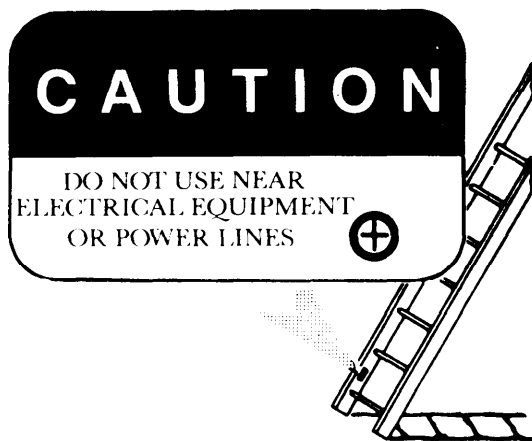
Identification is essential throughout the life of any part. The nomenclature, with its associated number



**Figure 6-3. Placement of Labels for Hazardous Tasks (Ref. 11)**



(A) Example of an Informative Warning Label



(B) Example of Specific Warning Label on Metal Ladder

**Figure 6-4. Examples of Informative Labels (Ref. 11)**

manufacturer and or National Stock Number (see par. 3-6.9) uniquely defines the item for ordering from the manufacturer, supply, and inventory control.

When parts cannot be physically marked because of lack of space, e.g., too small, or because marking would have a deleterious effect, the information specified in par. 6-3.2 should be marked on the container (Ref. 3) in addition to the identification marking information specified in MIL-STD-129 (Ref. 12). Where polarity or impedance rating are critical, the identification should so indicate. Some parts, because of their small size, e.g., resistors, are color coded to reveal their ratings and quality. For example, a gold marking on a resistor indicates  $\pm 5\%$  of its rated value, a silver marking,  $\pm 10\%$ .

A part number and the drawing number detailing the part are the same. As a drafting practice, each part on the drawing or schematic should be keyed to the description of the part shown elsewhere on the drawing or schematic. A wiring diagram prepared in accordance with the schematic should carry identification for wire, sockets, plugs, receptacles, resistors, transistors, capacitors, etc. Terminals on all assemblies and parts should be suitably marked, and the wiring should have all terminal markings. Circuit cards should show the part number or a code to assure the correct positioning of parts to be affixed to the card. Each mechanical part that will require repair or replacement must be identified by a unique name and number.

**6-4 METHODS OF LABELING**

There are numerous marking processes available, and each one has advantages and limitations. A marking process should be selected only after a review of the part design (material, type of construction, marking space available, and environment in storage and use); the type of surface to which it will be applied; the best location for visibility or durability; and any remarking requirements that may result from engineering changes. Markings and designations are applied either directly to the item—i.e., part, framework, panel, chassis, or end item—or by attachment of separate plates bearing the desired designations. The commonly used methods of applying the characters are ink stamping, steel stamping, engraving, molding-in, decalcomania transfer, stenciling, photoetching, metal plates, tags, photocontact, screen printing, and adhesive-backed labels of metal or plastic. Special features that pertain to each of these processes, their limitations, and preferred types of applications are described in the subparagraphs that follow.

Despite the fact that this is a maintainability handbook, the production advantages and disadvantages associated with the various application methods are included because—since labeling is such a seemingly unimportant consideration—they may not be well-known. This information will enable the maintainability

## DOD-HDBK-791(AM)

engineer to engage in a meaningful dialogue with the production engineer relative to trade-offs. If any of several labeling methods will satisfy the labeling requirement, the method chosen should be the one that simplifies the production task; conversely, if only a particular method will satisfy the requirement, the maintainability engineer must insist on the method regardless of the increased production effort.

### 6-4.1 INK STAMPING

This method is widely used, primarily for piece parts. In this technique ink is applied with a rubber stamp. Water-petroleum-soluble inks should not be used. Ink stamping by hand can be awkward, especially when the length of the stamp is much greater than the height.

The chief production advantages of this method are that it is easy to apply and can be changed during manufacture or in the field. The maintainability advantages are that the process does not alter the surface finish, and it can be used in small, restricted areas. The disadvantages are chiefly lack of durability, the characters may not be sharply defined, the stamp does not conform to uneven surfaces, ink is subject to smudging, and ink can be applied unevenly.

### 6-4.2 STEEL STAMPING

This method of marking provides identification of mechanical parts at a low cost; it is permanent and not subject to deterioration in any environment. However, care must be taken to assure that the stamping procedure does not damage the part. Steel stamping will penetrate anticorrosion coatings and painted surfaces and will render them ineffective where the item is stamped. It may also produce sites susceptible to stress corrosion to which the material may otherwise be immune. This method cannot be used on surfaces that are subject to wear or on items that are installed through a gland or packing because the roughened surface will cause damage.

One of the more common uses of steel stamping is to add specific identification data to preprinted metal identification plates, which are attached subsequently to production run hardware. The plates may be brass or stainless steel (avoid bare, dissimilar metals in contact with each other because of galvanic action), printed or reverse-etched, with spaces allocated for stamping the part identification information on as one of the final steps in the manufacturing process.

### 6-4.3 ENGRAVING

Engraving is the act of cutting characters into the surface with a tool; it has the same wearing qualities as steel stamping. However, the cost of engraving is high and production is slow. Engraving will penetrate anticorrosion-coated surfaces and painted surfaces and will render

them ineffective where the item is engraved. This method also may produce sites susceptible to stress to which the material may otherwise be immune. It can be applied to nonwearing surfaces that are too thin for steel stamping. The "electric pencil" marking device is one type of engraving tool that is often used for marking metal parts. This method is not generally accepted for formal identification purposes because the resulting label may be illegible.

### 6-4.4 MOLDING-IN

For flat surfaces requiring no additional marking or work after casting, molding-in is an effective and inexpensive method of permanently identifying a part. The identification is permanent. When used with sand castings, care must be exercised to ensure that the identification is not washed out in the molding process. A washout may make numerals such as 0, 6, and 8 indistinguishable from each other or completely eliminate the part identifier.

### 6-4.5 DECALCOMANIA TRANSFER

Decalcomania transfer (decals) are a printed design or characters on thin plastic material that is mounted on a paper backing for handling and storage. It is applied by soaking in water until the transfer is loosened from the paper and then carefully sliding the transfer off the paper and into place on the item. The transfer is held on the surface by a lacquer-type adhesive. Some decals are of the open-letter type, i.e., individual letters and numerals, which permit on-the-spot composition of labels. An overcoating of lacquer or clear varnish—compatible with the finish coating on the part—usually is applied to add stability to the composed label. Decals are not wear resistant and are not acceptable for areas subject to repeated handling or to any type of abrasion. They can be applied to metal, glass, plastic, or organically finished surfaces. Decals with water-soluble coatings should not be used. Additional advantages of decals are that they can be of any size and can be multicolored.

### 6-4.6 STENCILING

Stenciling is applying ink to an item through an outline of the characters—the stencil. It is a common method for marking the outside of shipping containers and is often used for vehicle identification. Stencils are made of heavy, treated paper or thin plastic, and the characters are punched out by a stencil-cutting machine. Stenciling is a relatively slow process, but stencils can be applied to uneven surfaces and to any material if the stenciling ink is compatible with the surface finish.

If stenciling is to be applied to plastic, a cover coating allowing the stencil to take usually may be omitted provided the stenciling ink meets the requirements of Federal Specification TT-1-1795 (Ref. 13). For some plastics, however, that exhibit a slick surface, e.g., polyethylene, a cover coating is necessary.

### 6-4.7 PHOTOETCHING

Photoetching—a photomechanical process by photographing an image on a metal plate and then etching—can be applied to metal surfaces. Reverse photoetching is normally specified for metal marking. In this process the characters are printed or drawn to an enlarged scale and a photographic reproduction, reduced to proper size, is made on the surface to be marked. The characters are then treated to make them resistant to the etching agent, acid. When acid is applied, the unprotected area (background) is etched out, which leaves raised characters. The photoetching process is frequently used for making standard identification plates that are later stamped to insert information for the specific item to which it is attached.

### 6-4.8 METAL PLATES

Metal plates are generally used to label vehicles, tanks, aircraft, and ground support equipment. The plates are marked with the categories of required identification data, and spaces are left for inserting the data for the specific item of equipment. The metal plate can be attached with screws, rivets, or adhesive, as desired. The chosen method of attachment should be compatible with the operational environment anticipated for the item. The equipment, plate, and fasteners should be of the same metal unless they have a protective coating to prevent corrosion resulting from galvanic action.

### 6-4.9 TAGS

Tags are pieces of paper, plastic, or metal that are attached to an item when it is not possible or convenient to apply information directly to the item. Tags are often used for attaching shipping information to a loose item, and they can be used to carry imprinted identification information when the item is too small to accept the necessary characters on its body (see par. 6-3.5). Usually, the tag is used only during stocking and shipping and is removed at the time of installation. It is common practice to mark failed items by attaching a rejection tag that remains attached until the item is repaired. The disadvantages of tags are that they can get in the way of work, can become tangled with other items, and can be easily separated from the item.

### 6-4.10 PHOTOCONTACT

The photocontact process should be used where precision markings are required, e.g., on dials. This process exposes a sensitized surface by means of a photonegative containing the desired legend. The exposed surface is processed to develop the image. This process can be applied to metallic and nonmetallic materials. An advantage is that a lot of information can be displayed in a small space.

### 6-4.11 SCREEN PRINTING

Screen printing (silk screening) is a relatively inexpensive method for marking parts. It can be applied to a wide variety of materials and items, and almost any size of item can be marked. It is particularly suitable and economical for small and medium production runs. Screen printing is a paint process and, therefore, should not be used on the handling or wear surfaces of controls. This process is useful for applying function data to valves, and control and dial labels to control panels.

### 6-4.12 ADHESIVE-BACKED LABELS

Adhesive-backed plastic or metal labels are a common method for marking items for function and for marking part locations on equipment. Photoetched metal plates used for part identification are often applied with an adhesive, rather than with screws, whenever the environment allows this method. Adhesive-backed labels may be applied on painted surfaces and directly on metal or plastic.

## 6-5 LABELING

Labels are lettered or diagrammatic indications of the name, identifying number, and function of equipment; they are affixed on or near the relevant equipment or function. They may include lettered warning signals and abbreviated instructions (both lettered and diagrammatic) relating to the operation or maintenance of the equipment. Operation and maintenance instruction manuals are not often readily available at the equipment, and meaningful labeling can be a satisfactory substitute in many instances. When evaluating the need for and content of labels, it is usually better to overlabel than to underlabel. The characters, markings, and symbols on labels and signs should remain sharp, have high contrast, and be resistant to wear.

The subparagraphs that follow present recommendations for organization and wording, displacement and positioning, size, and color of labels. The discussion on placement and positioning also presents some recommendations for the application of specific types of labels--nomenclature, warning, instructions, and identification of specific subsystems.

### 6-5.1 LABEL CONTENT

The label content must be consistent with the criticality of the information that it attempts to convey—i.e., part identification, function of the equipment, or hazards as indicated in par. 6-2. The label content also will be determined by equipment function, i.e..

1. Describe in terms that the typical observer, operator, or technician understands. Engineering characteristics, nomenclature, or other terminology should only be used when a commonly understood term does not exist.

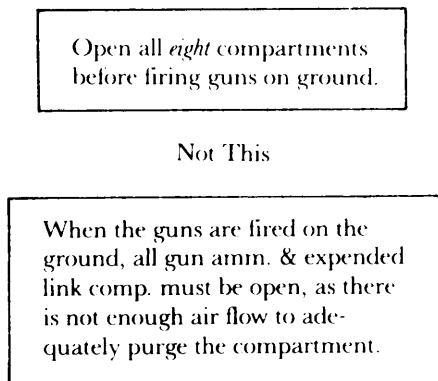
## DOD-HDBK-791(AM)

2. Label each control and display.
3. Indicate the functional result of the control movement—e.g., increase, decrease, slower. Where applicable, the label may include calibration data. Labels should be visible during operation (see par. 6-5.2). The functional result term should be at the end of an arrow.
4. Label instruments in terms of what is being measured or controlled; the use and purpose should also be considered.
5. Indicate functional relationships when controls and displays must be used together, e.g., adjustment tasks.
6. Avoid highly similar names for different controls and displays.

Once the purpose or intent of the label has been determined, the following guidelines are applicable for displaying the information:

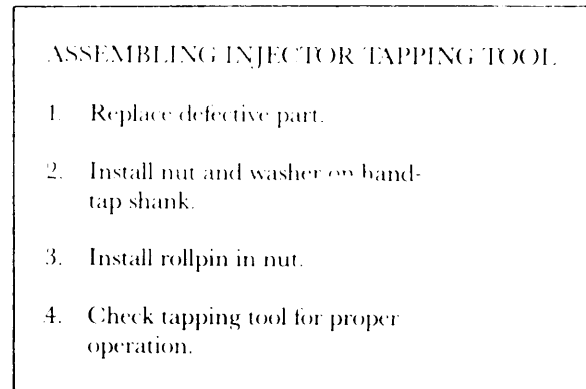
1. Make label content brief but explanatory— use as few words as possible to convey the intended meaning. Special markings or symbols, e.g., arrows and pictorials, should be considered only when they will unambiguously convey meaning in a more direct manner than several words. Labels should only provide reminders, as shown in Fig. 6-5, for the trained technician; they need not provide complete instructions.
2. Use abbreviations only when they will be meaningful in the overall statement. When used, standard abbreviations should be selected in accordance with MIL-STD-12 (Ref. 14), MIL-STD-411 (Ref. 15), MIL-STD-783 (Ref. 16). If these references specify the same abbreviation for more than one function, such abbreviation should not be used for more than one function. If a new abbreviation is required, its meaning should be obvious to the intended observer (Ref. 4).

3. Itemize—when a label lists a number of steps to be performed in an established sequence—each step, rather than compose the steps, in narrative form as illustrated by Fig. 6-6.

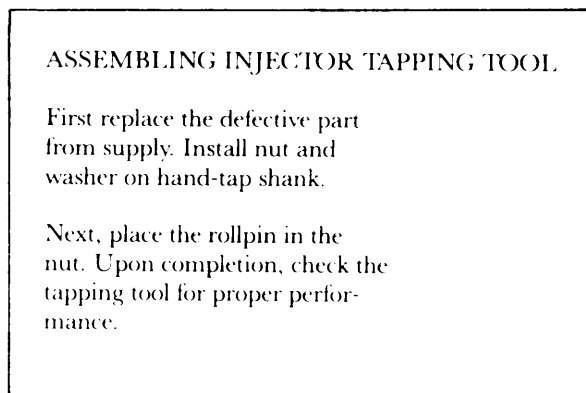


**Figure 6-5. Example of Label Brevity (Ref. 11)**

This



Not This



**Figure 6-6. Example of Step-by-Step Instructions**

4. Make part identification and equipment labels consistent with both the technical manuals and supply catalogs.

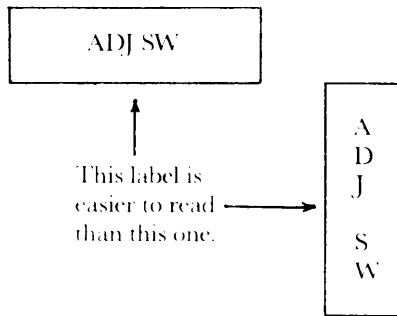
5. Compose labels so that they read from left to right as indicated in Fig. 6-7. Vertical arrangements should be used only when they are not critical for personnel safety and task performance and where space is limited. When used, vertical labels should read from top to bottom (Ref. 4).

6. Specify directional arrows that are as clearly recognizable and identifiable as possible when read at a distance. The direction of arrows with sharp angles and clean lines, as illustrated in Fig. 6-8 (Ref. 9), is less easily misinterpreted at a distance than that of arrows with wider angles and broader overall width-to-angle ratios.

The following Military Standards and Military Specifications should be referred to to insure that the format of the label content is consistent with the military requirements:

1. MIL-STD-130 (Ref. 3)
2. MIL-STD-195 (Ref. 17)
3. MIL-STD-411 (Ref. 15)

4. MIL-STD-454 (Ref. 8)
5. MIL-STD-1247 (Ref. 9)
6. MIL-E-11991 (Ref. 18)
7. NAT-STD-2027 (Ref. 19).

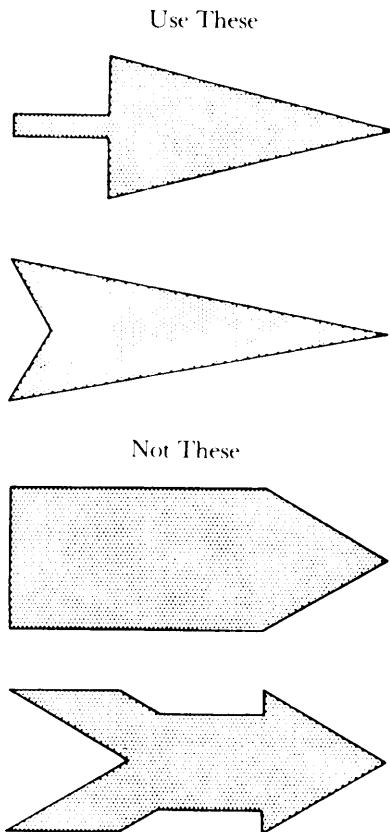


**Figure 6-7. Example of Horizontal Labels to Facilitate Reading**

viewpoint reference when he needs to see them, i.e., the observer should not be required to assume an unusual position to see a label. The following guidelines should be applied in the determination of the proper location for labels and markings:

1. Locate identifying labels for a major assembly
    - a. On main chassis of the equipment
    - b. Externally in a position so that the label is not masked by adjacent assemblies or components
    - c. On flattest, most uncluttered surface available.
- Avoid positioning of labels on curved surfaces, particularly surfaces with sharp radii because—when viewed from the side—the entire label may not be in view.

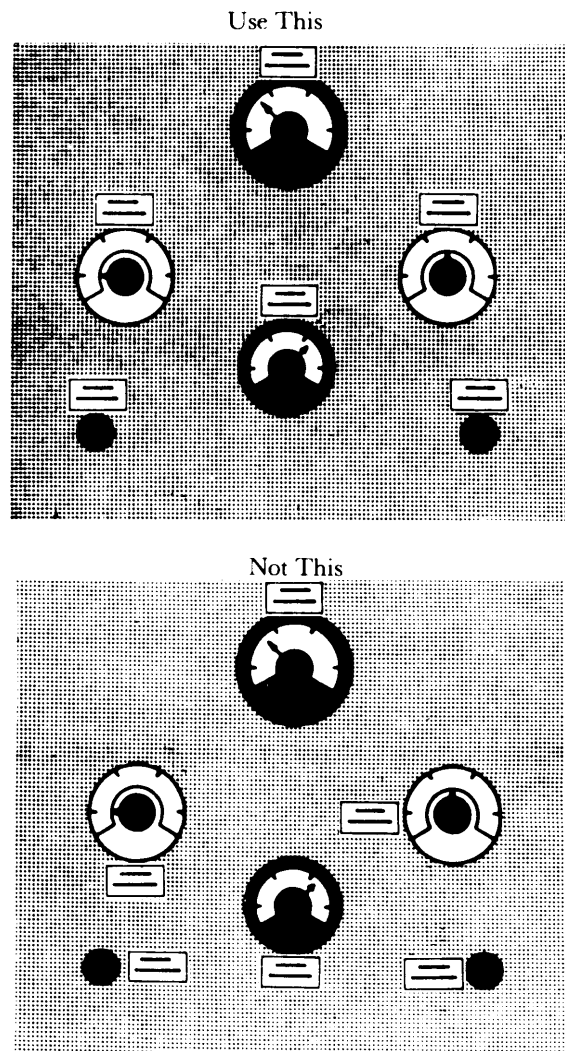
2. Place labels consistently above or below a control or display on a given panel. The “above” position is preferred except when the panel is located considerably above the observer’s eye (Ref. 4). Fig. 6-9 illustrates the “above” position arrangement.



**Figure 6-8. Examples of Preferred Arrow Shapes (Ref. 11)**

**6-5.2 LABEL PLACEMENT AND POSITIONING**

The positioning of labels and information is important. Labels, signs, and markings should be positioned so that they are visible from the normal or expected observer’s



**Figure 6-9. Example of Consistent Positioning of Labels**

**DOD-HDBK-791(AM)**

3. Locate label so that a control handle will not mask the label as illustrated in figure. 6-10 (Ref. 4).

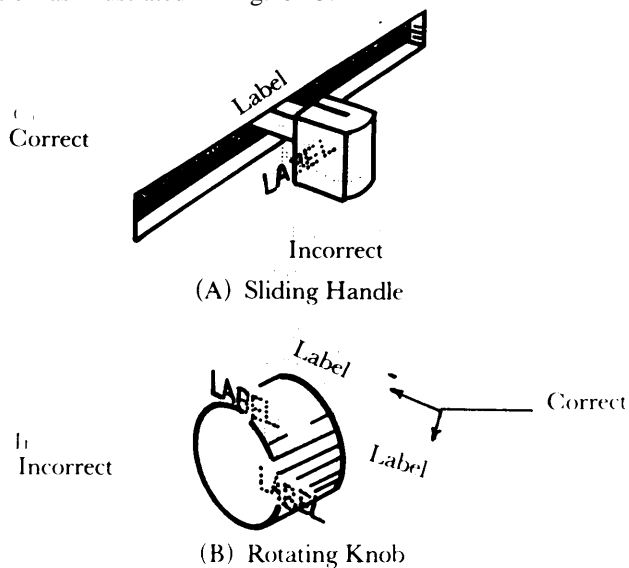
4. do not locate label on a control that could rotate the label to an upside down position as illustrated in Fig. 6-11 (Ref. 4).

5. Do not place labels near the floor, as illustrated by Fig. 6-12 (Ref. 4), or other positions that preclude the observer from getting his eye in an adequate position for reading the label.

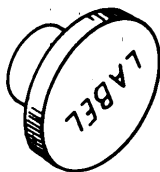
6. When a frame is used to inclose a functional group to define its boundaries, center the label at the top of the group either in the frame or just below the frame boundary as illustrated in Fig. 6-13.

7. Place labels where they will not become obliterated by grease, filings, dirt, or moisture. If a label is particularly susceptible to being obliterated by materials dropping from above or masked by manuals placed on the surface, locate the label on a vertical surface as illustrated by Fig. 6-14.

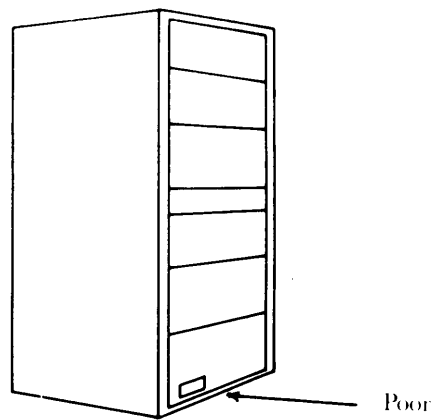
8. When the direction of motion to perform a function or the position of a control is critical to an operation. locate labels to indicate the direction of motion or condition as illustrated in Fig. 6-15.



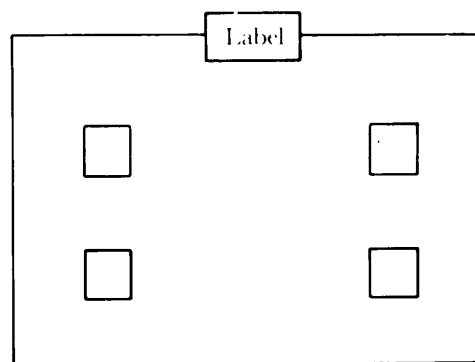
**Figure 6-10. Examples of Method of Positioning Labels to Avoid Masking by Control Handles (Ref. 4)**



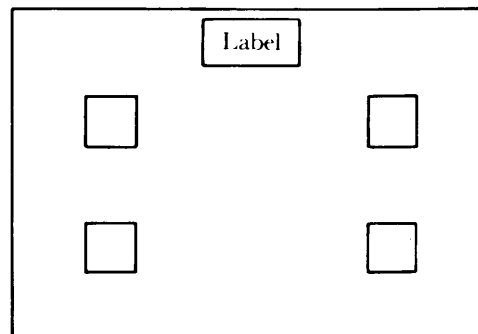
**Figure 6-11. Example of Label Placement Which Can Result in Upside-Down Position (Ref. 4)**



**Figure 6-12. Example of a Poor Placement of Label (Ref. 4).**

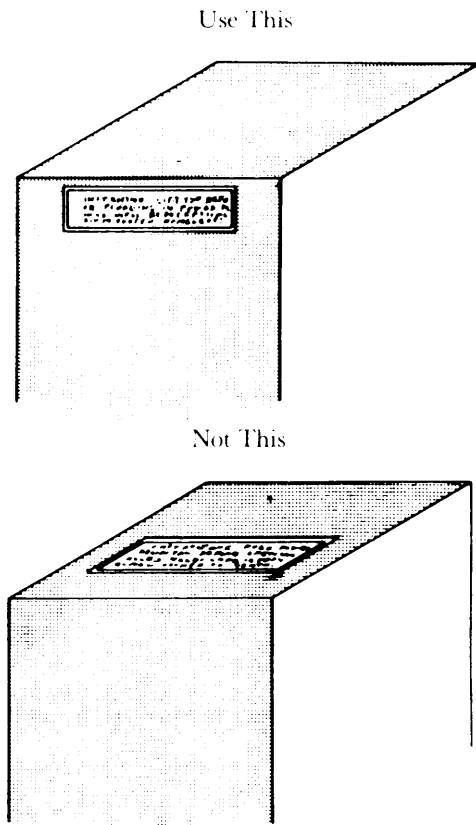


(A) Label in Boundary

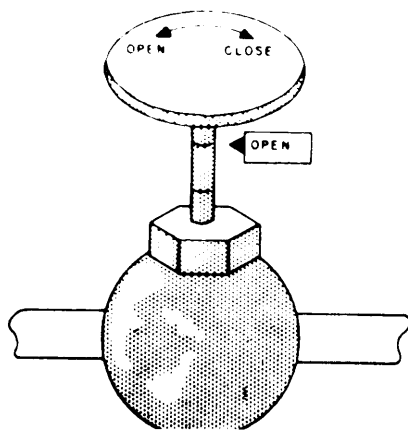


(B) Label Below Boundary

**Figure 6-13. Example of Label Location for a Panel**



**Figure 6-14. Example of Placement of Label on Vertical Surface**



**Figure 6-15. Labels for Valve Controls (Ref. 11)**

### 6-5.3 LABEL DESIGN

Labels and placards should be designed for easy and accurate reading at the expected reading distances, vibration or motion environments, and illumination levels. To achieve ease of reading, the following factors must be considered:

1. Color contrast between lettering and immediate background
2. Height, letter width, stroke width, spacing, and style of letters and numerals
3. Method of application—e.g., adhesives, etching, decal, silk screen.

Each of these factors is discussed in the paragraphs that follow.

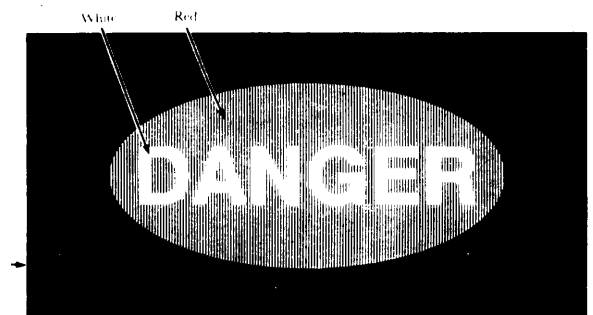
#### 6-5.3.1 Color Contrast and Background (Ref. 4)

Label background colors should contrast visually with equipment background specified in MIL-STD-1473 (Ref. 20). No special additional background for the label should be used on the equipment without approval of the procuring authority. Placards or signs that include their own independent background should provide maximum contrast between lettering and immediate background. Shiny metallic backgrounds should not be used for operational labels, placards, signs, or markings.

Instruction plate markings should be printed in white letters on a black background. Caution plates (see Fig. 6-16) or decals should be printed in yellow letters on a black background in conformance with AR 385-30 (Ref. 21). Danger signs (see Fig. 6-17) should be printed in white letters on an oval red background upon a black background (Ref. 22).



**Figure 6-16. Example of a Caution Sign (Ref. 21)**



**Figure 6-17. Example of a Danger Sign (Ref. 22)**

**6-5.3.2 Letter and Numeral Size and Font (Ref. 4)**

Type style (font), letter or numeral width, character stroke width, stroke continuity, character spacing, word spacing, line spacing, and character height all contribute to the ease with which a label may be read. Each of these factors is discussed in the paragraphs that follow.

**6-5.3.2.1 Type Style**

To identify the type to be used for label composition, specify the style, the name, and the height in units of length. The printer's measure of height, the point = 1/72 in., is an ambiguous measure for designating height the same point size of a given style may be interpreted incorrectly, e.g., a lowercase "x" has a different point size than a lowercase "f".

Letters and numerals should be of simple style without serifs except as may be necessary to distinguish between characters that would otherwise be confused, e.g., I and 1. Acceptable styles are listed in Table 6-1 (Ref. 4).

**6-5.3.2.2 Letter or Numeral Width (Ref. 4)**

The width-to-height ratio should be between 3:5 and 1:1 for all characters and styles except the "I" and "1". The 1:1 ratio is appropriate for use on curved surfaces such as counter drums, small pipes, and cables.

**6-5.3.2.3 Character Stroke Width (Ref. 4)**

When characters are used on a light background, the stroke width should be approximately 1/6 the height of the character. When light characters are used on a dark background, the stroke width should be 1/7 to 1/8 the height of the character. These ratios apply regardless of how high characters are made for distant viewing. However, for certain applications, characters with different stroke widths may be used for emphasis. In this case the thinnest character stroke should be no less than 1/8 nor the thickest character stroke greater than 1/5 respective character heights.

**TABLE 6-1  
CLOSE EQUIVALENT TYPEFACES  
SUITABLE FOR LABELING (Ref. 4)**

Type Font	
Airport Bold Condensed	Futura Demi-Bold
Airport Demi-Bold	Futura Medium
Airport Medium Condensed	Futura Bold
Airport Semi-Bold	Groton Condensed
Alternate Gothic #2	lining Gothic #66
Alternate Gothic #3	Spartan Heavy
Alternate Gothic #51	Spartan Medium
Alternate Gothic #77	Tempo Bold
Franklin Gothic Condensed	Vogue Medium

**6-5.3.2.4 Stroke Continuity (Ref. 4)**

Continuous stroke characters should be used where applicable and practical for all equipment labels, legends, placards, and signs. Stencil characters may be used for shipping containers; however, stencil characters should not have stroke breaks greater than 1/2 the character stroke width. Stencil stroke widths should conform to the requirements of par. 6-5.3.2.3.

**6-5.3.2.5 Character Spacing (Ref. 4)**

The minimum space between characters in a word should be one stroke width. However, character spacing should be adjusted to provide an appearance of "open area balance" within single words i.e., when adjacent vertical strokes between adjoining characters are compared to adjacent characters in which vertical components are far apart, the word will appear to be properly spaced. In such cases, the space between adjacent vertical strokes should be slightly wider than between vertical horizontal or horizontal horizontal strokes.

**6-5.3.2.6 Word and Line Spacing (Ref. 4)**

The preferred space between words is the width of one character, except for "I" or "1". The minimum spacing between words should not be less than 1/2 the width of one character.

The minimum space between lines should be 1/2 the character height.

**6-5.3.2.7 Character Height (Ref. 4)**

Character height for labels, legends, and signs should be determined on the basis of the critical in Figs. 6-18 and 6-19.

The linear equation represented by Fig. 6-19 is

$$y = \frac{7.6}{3} x, \text{ mm} \quad (6-1)$$

where

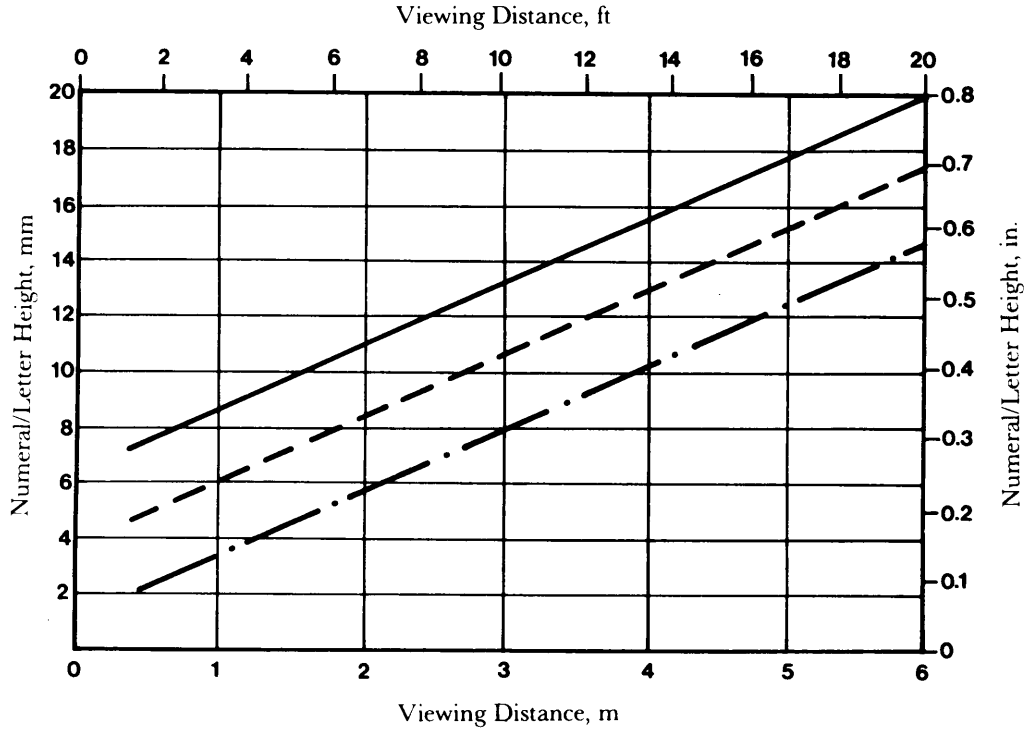
y = numerical or character height, mm  
y = viewing distance, m.

Eq. 6-1 provides a convenient method for calculating the numeral or letter height for any viewing distance.

If a panel within a given piece of equipment or console must be labeled to identify it from other-s, i.e., when a panel integrates a specific operating function as distinct from another panel, functions on the panel and individual components should be differentiated in terms of the letter size (height). The size encoding should progress as follows

Letter Height versus Viewing Distance  
and Illumination Level

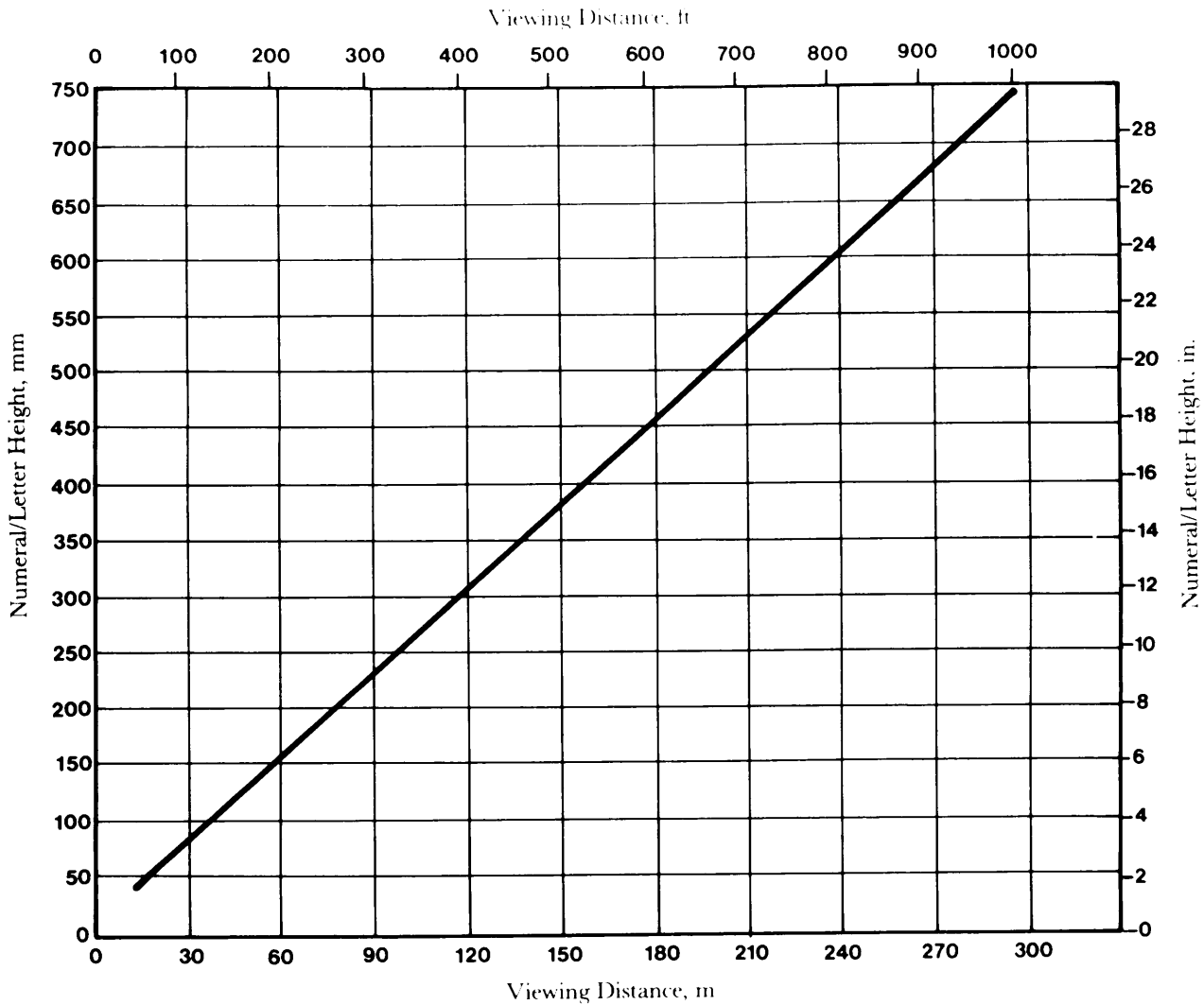
(Minimum Space Between Characters, 1 Stroke Width;  
Between Words, 6 Stroke Widths)



- For instruments where the position of the numerals may vary and the illumination is between 1.0 and 3.4 cd/m<sup>2</sup> (0.3 and 1 fl).
- - - For instruments where the position of the numerals is fixed and the illumination is 1.0-3.4 cd/m<sup>2</sup> (0.3-1 fl), or where position of the numerals may vary and the illumination exceeds 3.4 cd/m<sup>2</sup> (1 fl).
- . - For instruments where the position of the numerals is fixed and the illumination is above 3.4 cd/m<sup>2</sup> (1 fl).

Note: For marking of Aircrew Station Displays see MIL-M-18012B.

**Figure 6-18. Character Height Criteria for Instruments, Panels, and Equipment Viewed in Close Proximity Under Various Illumination Levels (Ref. 4)**



**Figure 6-19. Character Height for Viewing Signs at Extended Distances (Ref. 4)**

4. Smallest label for individual components, displays, and controls. Label should be compatible with the expected viewing distances. However, to provide discriminable differences among label sizes, each label character height should be at least 25% larger or smaller than the next function label. Fig. 6-20 illustrates this hierarchy.

**6-5.4 METHOD OF APPLICATION**

Methods of application together with their advantages, disadvantages, legibility, and permanence are discussed in par. 6-4.

**6-6 COLORS FOR LABELS AND SIGNS**

Color combinations of printing and background should be selected to maximize legibility. The best color combinations in descending order are given in Table 6-2.

If color codes, labels, and signs are necessary, select colors on the basis of recognizable differences. the colors indicated in Table 6-3 are ideal for surface coding because they are easily recognizable by both normal and color deficient observers. when related displays and controls are color coded, they should be coded the same color. all emergency controls should be coded in red.

Color coding for hose, pipe, and tube lines for aircraft and missiles should be in accordance with par. 5.1.1, MIL-STD-1247 (Ref. 9). Color codes for pipelines should be in accordance with par.4, MIL-STD-101 (Ref. 10).

Caution and danger signs should be color coded as described in par. 6-5.3.1 and illustrated in Figs. 6-16 and 6-17, respectively. Signs indicating a radio frequency radiation hazard should be coded as indicated in fig. 6-21 (Ref. 24). signs indicating a nuclear radiation hazard should be coded as shown in fig. 6-22.

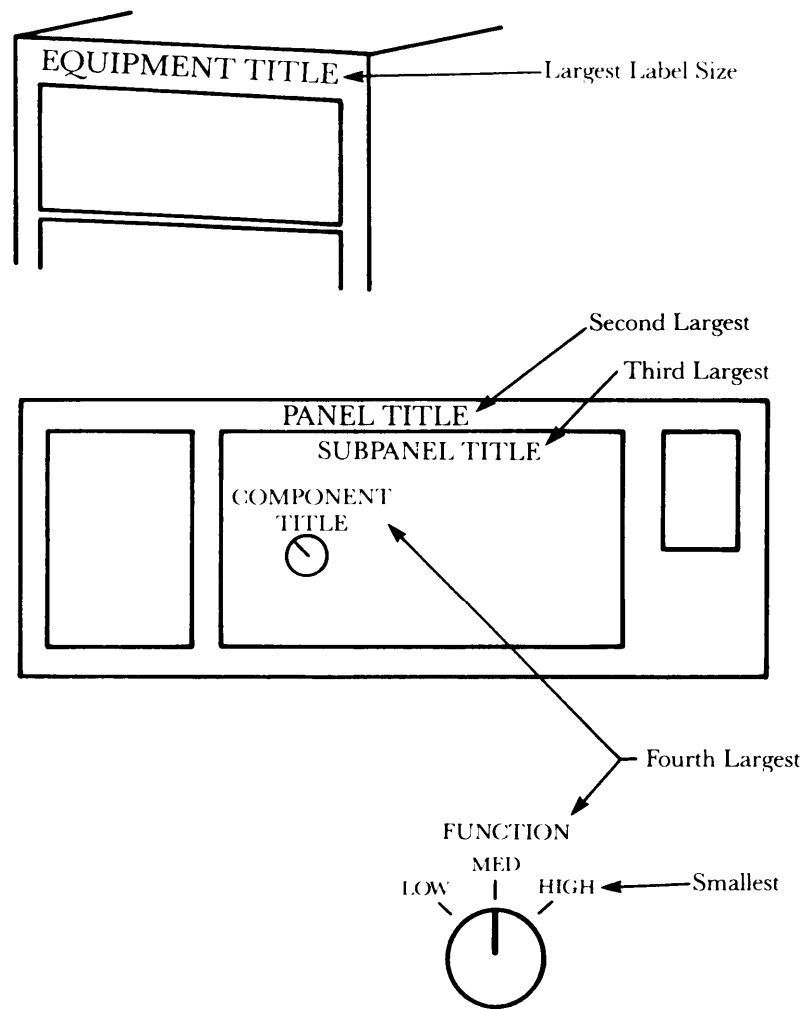


Figure 6-20. Label Size-Hierarchy Example for Equipment, Panel, Subpanel, and Component Identification (Ref. 4)

**TABLE 6-2. BEST COLOR COMBINATIONS IN DESCENDING ORDER**

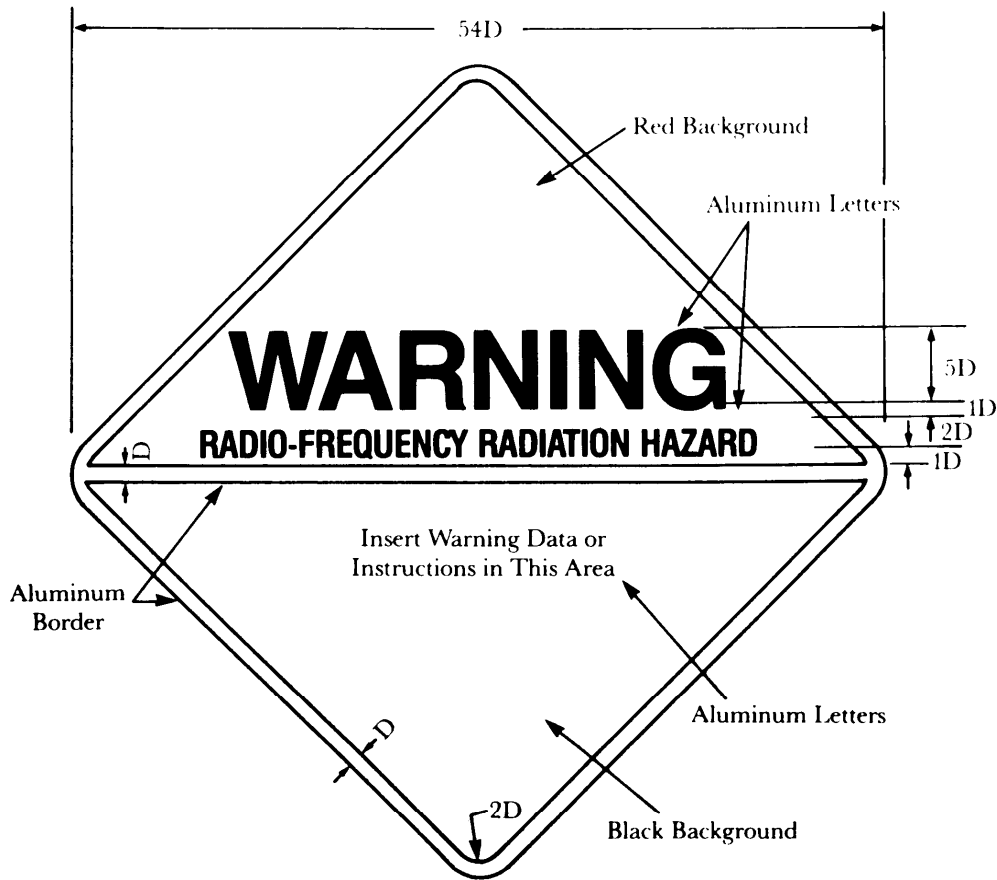
- Blue on White
- Black on Yellow
- Green on White
- Black on White
- Green on Red
- Red on Yellow

**TABLE 6-3. RECOGNIZABLE COLORS**

Color	FED-STD-595A Code No. (Ref. 23)		
	Gloss	Semigloss	Lusterless
Red	*11105	21105	—
Orange	12246	22246	32246
Yellow	**136559	23655	—
Green	14260	24260	—
Blue	15102	25102	—
Magenta	17142	27142	—
White	17875	27875	37875
Black	17038	27038	37038

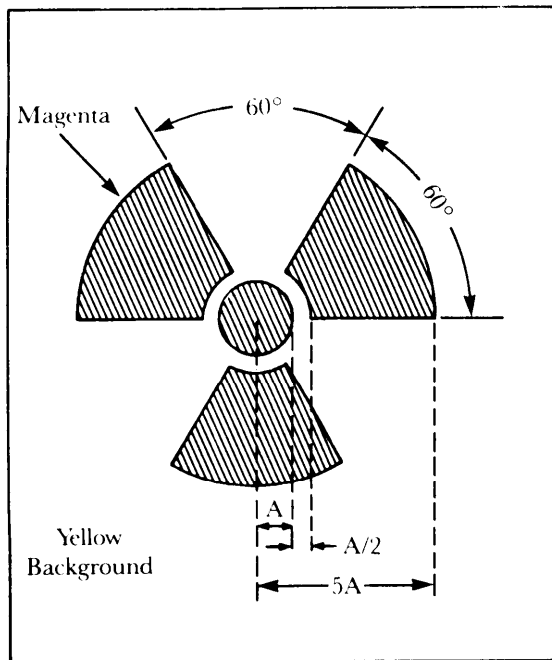
\*Red No. 11136 may be used instead of 11105.

\*\*Yellow No. 13538 may be used instead of 13655.



- 1 Place handling and mounting instructions on reverse side.
- 2  $D =$  Scaling unit
- 3 Lettering: Ratio of letter height to thickness of letter lines.
  - Upper triangle: 5 to 1 Large
  - 6 to 1 Medium
  - Lower triangle: 4 to 1 Small
  - 6 to 1 Medium
- 4 Symbol is square; triangles are right-angle isosceles.

**Figure 6-21. Radio Frequency Radioation Hazard Warning Symbol**



**Figure 6-22. Nuclear Radiation Hazard Warning Symbol**

## 6-7 IDENTIFICATION CHECKLISTS

Table 6-4 lists items to consider for proper identification. Several items are included that were not discussed in the text, but they are included here because they are important to good design and might otherwise be overlooked. The designer, maintainability engineer, human factors engineer, product engineer, and Configuration Management Office must work together during design to insure that all facets of proper identification are covered. When evaluating the design in accordance with the checklist, if the answer to any question is “no”, the design should be studied carefully to determine the need for, and proper application of, improvements in identification.

**TABLE 6-4. IDENTIFICATION CHECKLIST**

1. Are all units labeled and, if possible, with full identifying data?
2. Are parts stamped or labeled with relevant characteristics information?
3. Are structural members stamped with physical composition data—e.g., can be welded; is flammable?
4. Is each terminal labeled? Does the label have the same code symbol as the wire attached to it?
5. Are labels on components or chassis (not parts) etched or embossed in lieu of stamping or printing?
6. Are labels placed for full, unobstructed view?
7. On equipment using color coding, is the meaning of the colors given in manuals and on an equipment panel?
8. Is color coding consistent throughout the system; are displays and controls the same color?
9. Are numeral and letter designs used that have simple configurations equivalent to typed letters?
10. Are capital letters used for labels and standard capitalization, and lowercase type used for extended text material?
11. Are the lowercase “ell” (l), I, and 1 distinguishable from each other for the selected font; capital “oh” (O) from zero (0)?
12. Have standard abbreviations been used?
13. Are instructions brief, i.e., unnecessary words and punctuation omitted?
14. Are display labels imprinted, embossed, or attached in a manner that they will not be lost, mutilated, or become unreadable?
15. Do display and control labels clearly indicate their functional relationship? Are displays labeled by functional quantity—i.e., gal, psi, ohms—rather than by operational characteristics?
16. Does displayed printed matter always appear upright to the technician from his normal viewing position?
17. Do adequate labels appear on every item the technician must recognize, read, or manipulate?
18. Does display of the sequence of use of controls appear as a number on each control (for fixed procedure operation)?
19. Are display labels attached to each test point, and do they show intolerance or limits that should be measured at that point?

(cont'd on next page)

**TABLE 6-4 (cont'd)**

20. Are schematics and instructions attached directly to, or adjacent to, the chassis for all units that may require troubleshooting?
21. Do display labels on component covers provided relevant information concerning the electrical, pneumatic, or hydraulic characteristics of the part?
22. When selector switches may have to be used with a cover panel off, is a duplicate switch-position label provided on the internal unit so the technician does not have to refer to a label on the case or cover panel?
23. Are displays labeled so they correlate with notations found in system diagrams, in technical manuals, or in related literature?
24. Do display schematics on separate assemblies show clearly any relationships to other or interconnecting schematics?
25. Are color codes for identifying test points or tracing wire or lines easily identifiable under all conditions of illumination, and are they resistant to damage or wear?
26. Is functional organization of displays and controls emphasized by use of such techniques as color coding, marked outline, symmetry of grouping, and/or differential plane of mounting?
27. Are all potted parts labeled with current, voltage, impedance, or terminal information?
28. Are lubrication points properly labeled?
29. Are labels used to indicate the direction of movement of controls, especially where lack of such knowledge may result in damage to equipment?
30. Are labels used to indicate type of fluids at fill or service points and on lines?
31. Are labels on panels, components, and subassemblies differentiated in terms of letter size to indicate the hierarchy?

## REFERENCES

1. Melvin S. Majesty, "Personnel Subsystem Reliability for Aerospace Systems", Proceedings. ISA Aerospace Systems Reliability Symposium, 16-18 April 1962, p. 199.
2. W. P. Chase and P. R. Tobias, "Rocket Engine Damage Causes and Cures", *Western Aviation, Missiles and Space*, August 1961.
3. MIL-STD-130F, *Identification Markings of US Property*, 2 July 1984.
4. MIL-HDBK-759A, *Human Factors Engineering Design for Army Materiel*, 31 December 1985.
5. MIL-STD-280A, *Definitions of Item Levels, Item Exchangeability, Models and Related Terms*, 7 July 1969.
6. MIL-P-514D, *Plate, Identification, Instruction and Marking, Blank*, 7 July 1971.
7. MIL-STD-882B, *System Safety Program Requirements*, 30 March 1984.
8. MIL-STD-454J, *Standard General Requirements for Electronic Equipment*, 30 June 1985.
9. MIL-ST D-1247B, *Marking Functions and Hazard designations of Hose, Pipe, and Tube Lines for Aircraft, Missile, and Space Systems*, 20 December 1968.
10. MIL-STD-101B, *Color Code for Pipelines and for Compressed Gas Cylinders*, 3 December 1970.
11. J. W. Altman, et al., *Guide to Design of Mechanical Equipment for Maintainability*, ASD-TR-6-381, Air Force Systems Command. Wright-Patterson Air Force Base, OH, 1961.
12. MIL-STD-129J, *Marking for Shipment and Storage*, 25 September 1984.
13. Fed Spec TT-I-1795A, *Ink, Marking, Stencil, Opaque (Porous and Nonporous Surfaces)*, 17 March 1975.
14. MIL-STD-12D, *Abbreviations for Use on Drawings, Specifications, Standards, and in Technical Documents*, 29 May 1981.
15. MIL-STD-411D, *Aircrew Station Signals*, 30 August 1974.
16. MIL-STD-783D, *Legends for Use in Aircrew Stations and on Airborne Equipment*, 18 December 1984.
17. MIL-STD-195, *Marking of Connections for Electrical Assemblies*, 7 February 1958.
18. MIL-E-11991E, *Electronic, Electrical, and Electro-mechanical Equipment, Guided Missiles and Associated Weapon Systems, General Specification for*, 26 July 1983.
19. NAT-STD-2027, *Marking of Military Vehicles*, 15 December 1982.
20. MIL-STD-1473A, *Standard General Requirements for Color and Marking of Army Materiel*, 29 July 1983.
21. AR 385-30, *Safety Color Code Markings and Signs*, 15 September 1983.
22. ANSI Z35.1-1972, *Specifications for Accident Prevention Signs*, American National Standards Institute, 1430 Broadway, New York, NY 10018, 1972.
23. FED-STD-595A, *Color*, 30 August 1984.
24. ANSI C95.2-1982, *Radio Frequency Radiation Hazard Warning Symbol*, American National Standards Institute, 1430 Broadway, New York, NY 10018, 1972.

## BIBLIOGRAPHY

- ANSI Z53.1-1971, *Safety Color Code for Marking Physical Hazards*, American National Standards Institute, 1430 Broadway, New York, NY10018, 1971.
- MIL-STD-1472C, *Human Engineering Design Criteria for Military Systems, Equipment, and Facilities*, 10 May 1984.
- MIL-STD-190C, *Identification Marking of Rubber Products*, 17 October 1977.
- MIL-STD-1480C, *Color Codes for Webbing, Textile; Manufacturer's Identification*, 22 July 1974.
- FED-SPEC-TT-L-50G, *Lacquer, Nitrocellulose, Acrylic and Acrylic Butyrate, Aerosol*, 12 August 1977.
- MIL-M-18012B, *Markings for Aircrew Station Displays, Design and Configuration of*, 17 February 1972.
- MIL-I-43553A, *Ink, Marking, Epoxy Base*, 22 November 1985.
- MIL-M-11745C, *Marking and Labeling of US Army Marine Craft*, 25 July 1980.
- MIL-T-23991E, *Training Devices, Military; General Specifications for*, 20 February 1974.

**This page intentionally left blank.**

## CHAPTER 7

# TESTABILITY AND DIAGNOSTIC TECHNIQUES

*Testability} and diagnostics are defined, and their differences are discussed. The importance of introducing testability in early design is presented. The contribution of good diagnostic techniques to facilitate maintenance is emphasized. Built-in test equipment and automatic test equipment are defined, and examples of their use are given. Functional tests—such as detection, isolation, and prediction—are analyzed. Critical design considerations—such as personnel, software, test sequence, and stimuli—are detailed. The application of artificial intelligence and expert systems to improve programming techniques is presented. Examples of the design considerations are provided in several commodity areas. Checklists for testability and diagnostics complete the chapter.*

### 7-1 INTRODUCTION

The preponderance of the repair time required for any item, subsystem, or system normally is a direct function of fault isolation. Rapid advances in system complexity have aggravated the problem by reducing the effectiveness of conventional testing and diagnostic techniques. During the era when discrete components were used in quantity, it was possible to probe troubleshoot-electronic assemblies to isolate failures. Now there are layers of hermetic seals and programs stored in memory that obscure the technician's view into the physical processes of system operation (Ref. 1). Accordingly, it is imperative that provisions be made for the most effective diagnostic routines possible. The application of new techniques is not restricted to electronic systems; new techniques can also be applied to mechanical systems (see par. 7-3.4).

It is necessary that system testability as a discipline be incorporated into the design process for cost-effectiveness and to insure that diagnostic techniques and supporting test equipment are mature enough to support materiel delivered to the field. Decisions regarding testing also affect the logistical support plan. Factors involved in the decision include mission and operational characteristics for the equipment, anticipated reliability, maintenance structure, automatic fault isolation capability of built-in test, built-in test equipment (BIT)/(BITE), equipment and skill level of personnel available for maintenance, operational environment, development time, and cost.

Historically, testability has received a lower priority—effort and funding—than classic performance characteristics (Ref. 2). A change in philosophy is emerging, however, for complex and sophisticated weapon systems as evidenced by the award by the US Air Force of a \$3.2 million contract to the Boeing Military Aircraft Company to develop a prototype ground-based diagnostic system for the B-1B avionic system (Ref. 3).

The paragraphs that follow discuss testability, testability analysis, the relationship of testability to availability, diagnostic techniques and aids, functional testing, and design considerations.

### 7-2 TESTABILITY

#### 7-2.1 GENERAL

Testability is defined as a design characteristic that allows the status of a unit or system to be determined in a timely and cost-effective manner (Ref. 4). This definition distinguishes testability from diagnosis which describes the functions performed and the techniques used in detecting and isolating the cause of a malfunction or failure, e.g., the application of a physical or electrical stimulus to a device to produce a measurable response. Closely associated with testability and diagnostics are the terms BIT, BITE, and automatic test equipment (ATE). These terms are defined in pars. 7-3.5.2.3 and 7-3.5.2.2, respectively.

To illustrate the difference between testability and diagnostics, consider the function indicator lights on the dashboard of an automobile. The temperature indicator, which lights up when the engine overheats, represents continuous BITE. It will not isolate which component of the cooling system is at fault; it is not a diagnostic tool in the strictest sense. Now consider a pneumatic tire. The tire valve represents a designed-in test feature. The determination of the air pressure inside the tire by a pressure gage represents a diagnostic technique.

Good testability does not “just happen”; on the contrary, it is achieved by establishing a well-planned testability program that accomplishes the following general requirements (Ref. 4):

1. Establishment of sufficient, achievable, and affordable testability, built-in and off-line test requirements
2. Integration of testability into equipment and systems during the design process in coordination with the maintainability design process
3. Evaluation of the extent to which the design meets testability requirements
4. Inclusion of testability in the program review process.

#### 7-2.2 TESTABILITY ANALYSIS (Ref. 5)

Testability analysis is defined as the element in the equipment design analysis effort related to developing the

diagnostic approach and then implementing that approach. The analysis includes BIT analysis, nodal analysis for partitioning, test point design, fault simulation, and diagnostic preparation for all levels of maintenance.

To be effective, testability analysis must be used to define diagnostic requirements before the detailed design of the major equipment is begun. During the detailed design, test point analysis and nodal analysis for partitioning should be major inputs to the layout or packaging design that contributes to modularization. Analysis of projected BIT performance and fault simulation studies should be used to evaluate the process to determine whether the BIT objective is being met and as inputs to a BIT maturation program. Design improvement data should also be extracted from test and operational data. For example, system components coming off the production line should be tested with equipment designed for eventual use by repair personnel. An analysis of the test results will reveal whether the test equipment can confidently and satisfactorily perform its diagnostic purpose.

Chapter 13, "Test and Evaluation (T&E)", *AMC-TRADOC Materiel Acquisition Handbook* (Ref. 6), sets forth procedures used to plan, evaluate, and report on the test and evaluation of materiel systems and or items. The types of test and evaluation performed, and the responsibilities of the US Army Materiel Command (AMC), US Army Training and Doctrine Command (TRADOC), operational tester, and other organizations in the test and evaluation process. The purposes and time frames as they relate to the various test programs from operational testing to production testing are defined.

Guidelines for conducting the testability analysis are

1. Question the process by which the developer defined his testability approach—how, why, and logic employed.
2. Insure testability design is concurrent with major equipment design.
3. Insure test point selection and design, and testability partitioning play a major role in system layout and packaging.
4. Insure that a failure modes and effects analysis was available and used as part of the testability analysis.
5. Insure that BIT analysis and fault simulation were used to evaluate the coverage and effectiveness of the BIT design if BIT is used. BIT development, integration, and checkout must be concurrent with system performance development.
6. Insure that the testability design approach evolves as information is obtained from analysis and test experience. Compare the results with the requirements.

### 7-2.3 INTERFACE RELATIONSHIPS

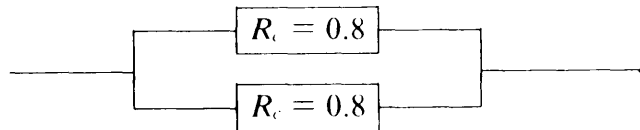
Equipment availability, measured as a probability, has two elements, i.e.,

1. The probability that an item is operable because it has not failed, i.e., is reliable
2. The probability that, if the item has failed or is down for maintenance, it can be restored to serviceable condition within the time permitted by mission constraints.

Any failed condition that is present and undetectable is not corrected and is, therefore, a part of the unreliability of a mission. This highlights the importance of testability because the incidence of undetectable failures can be reduced by designing equipment for a high degree of reliable testability. This attribute of the system is referred to as test effectiveness, or BIT efficiency, i.e., the percent of all faults or faults that the BIT system detects. one of the more complex tasks in the acquisition of modern weapon systems is the specifying of performance measures or figures of merit for BIT. It is becoming common practice that contracts for electronic subsystems and components specify the false alarm rate and the percent of failures that can be detected and isolated. Ref. 7 discusses the analysis performed on a complex digital data system wherein the BIT specifications required that 98% of all possible failures be detectable and that 90% of all failures be isolatable to one plug-in assembly. Par. 7.2-4 discusses and illustrates by example characteristics external to BIT.

It is obvious that testability interfaces with reliability, modularization, end-item configuration, space allocation, BIT, automatic test equipment (ATE), and logistics. Trade-off studies involving these factors will result in the most cost-effective method for achieving availability goals consistent with the mission of the system. Diagnostic techniques are important inputs to this analysis (see par. 7-2.2), and in some cases diagnostic techniques evolve from the analysis.

In the trade-off between reliability and testability, availability may be enhanced by designing a piece part to a higher level of reliability or by providing standby redundancy. Testability, with its BIT, introduces another component into the system that may fail, i.e., the BIT equipment may not reveal an undetected fault or may signal a false alarm. However, added redundancy may raise the reliability of a component to a level where testing is considered unnecessary. Consider the following redundant system



where the reliability  $R_c$  of a component is 0.8. The equation for calculating the improved reliability of this parallel redundant system, where  $k = 2$ , is

$$R = 1 - \prod_{i=1}^k (1 - R_c)^i = 1 - (1 - R_c)^2$$

(7-1)

or

$$R = 1 - (1 - 0.8)^2 = 0.96.$$

Since the reliability of the redundant system has been increased from 80% to 96%, which enhances overall system availability, testing of the circuit may be considered unnecessary and the BITE eliminated. Unfortunately, redundancy almost always increases the maintenance

workload, complicates fault detection, and increases cost. Depending upon the size of the added component, the increased weight and volume also may be a factor. Offsetting these negative aspects are the cost of providing test equipment, the time to conduct the test, and the time required to repair a mission-critical end-item.

**7-2.4 CHARACTERISTICS EXTERNAL TO BIT (Ref. 8)**

There are two important considerations external to BITE that must be addressed in any discussion of BITE and diagnostics, namely,

1. Reliable performance of the weapon system determines, to a large extent, the criticality of BIT performance. Therefore, if the basic system is very reliable, more than expected, a shortfall in the BIT performance may have very limited impact on the operational utility of the system.

2. All system faults that are correctable by maintenance action must eventually be detected and isolated. The Failure Modes, Effects, and Criticality Analysis (FMECA) is an effective tool for evaluating BIT effectiveness. The FMECA can be used in defining test and checkout procedures to insure that all essential parameters, functions, and modes are verified. Therefore, the techniques, tools, manuals, test equipment, and personnel required to isolate non-BIT detectable faults can be a major maintenance consideration.

Example 7-1, which follows, illustrates the impact of BITE on the overall maintenance planning effort. It also illustrates the effect of external factors on BIT equipment performance.

*Example 7-1:*

Assume the radar of an attack aircraft is composed of five line-replaceable units (LRUS) with the following BITE and system characteristics:

System:

Five LRUS

Mean Time to Repair  $(MTTR)_B$ — with BITE:

2-h—includes failures that have been both detected and isolated

Mean Time to Repair  $(MTTR)_{NB}$ —non-BITE:

5-h—includes failures that may not have been isolated but may have been detected

Mean Flying Hours Between Failures  $MFHBF$

50 flying hours

Time Period of Interest  $TPI$ :

2500 flying hours

BIT Specifications:

Percent detection  $R_{detect} = 90\%$

Percent isolation  $R_{isol} = 90\%$  (to LRU level)

False alarm rate  $R_{FA} = 5\%$  (of all BITE indications).

For this example, operating time is assumed to be flight time.

Before beginning the analysis, note that a relatively high BIT system capability has been specified. A casual examination would likely conclude that, with this extensive BIT coverage, there is minimal maintenance action required.

The notation used in the conduct of the analysis follows:

$AFIC$  = automatic fault isolation capability, %

$(F_B)_{detect}$  = number of failures of the total number of failures  $F_T$  that BITE will detect as true, failures

$(F_B)_{LRU}$  = number of BITE detected failures that can be isolated to LRU level, failures

$F_{FA}$  = number of false alarms expected during  $TPI$ , dimensionless

$(F_B)_{total}$  = total BITE indications of failure, i.e., true failure plus false alarms, failures

$F_T$  = total failures expected during  $TPI$ , failures

$R_{EA}$  = false alarm rate indicated by BITE, %

$MFHBF$  = mean flying hours between failures, flying hours

$(MTTR)_B$  = mean time to repair BITE detected and isolated failures h

$(MTTR)_{NB}$  = mean time to repair non-BITE detected and isolated failures, h

$R_{detect}$  = BITE detection rate, %

$R_{isol}$  = BITE isolation rate to LRU level, %

$(T_{FA})_{total}$  = total maintenance time to resolve false alarms, h

$(T_{LRU})_{total}$  = total corrective maintenance time to repair BITE detected and isolated failures, h

$(T_{NB})_{total}$  = total corrective maintenance time to repair non-BITE detected and isolated failures, h

$(T_{NB+FA})_{total}$  = total non-BITE corrective maintenance time to repair non-BITE detected and isolated failures plus false alarm maintenance time, h

$T_{total}$  = total corrective maintenance time during  $TPI$ , i.e., sum of BITE and non-BITE corrective maintenance time, h

$TPI$  = time period of interest, 2500 flying hours.

The analysis follows:

1. Total number of failures  $F_{total}$  to be experienced, on the average, are

$$F_{total} = \frac{TPI}{MFHBF}, \text{ failures} \quad (7-2)$$

where

$TPI$  = time period of interest, flying hours

$MFHBF$  = mean flight hours between failures, flying hours.

## DOD-HDBK-791(AM)

Therefore,

$$F_T = 2500/50 = 50 \text{ failures.}$$

2. Number  $(F_B)_{detect}$  of the total failures  $F_{total}$ , on the average, that BITE will detect as true are

$$(F_B)_{detect} = F_{total}R_{detect}, \text{ failures} \quad (7-3)$$

where

$$R_{detect} = \text{BITE detection rate, \%}.$$

Therefore,

$$(F_B)_{detect} = 50(0.9) = 45 \text{ failures.}$$

3. Number of failures  $F_{LRU}$  of  $(F_B)_{detect}$  that, on the average, will be isolated to an LRU are

$$F_{LRU} = (F_B)_{detect}R_{isol} \quad (7-4)$$

where

$$R_{isol} = \text{BITE isolation rate, \%}.$$

Therefore, since from Eq. 7-3  $(F_B)_{detect} = 45$ ,

$$F_{LRU} = 45(0.9) \approx 40 \text{ failures.}$$

4. The automatic fault isolation capability  $AFIC$  is

$$AFIC = R_{detect}R_{isol}, \% \quad (7-5)$$

$$= 0.9(0.9) = 0.81 = 81\%.$$

5. Number  $F_{AR}$  of false alarm indications, on the average, expected during the  $TPI$  are

$$(F_B)_{total} = (F_B)_{detect} + F_{FA}, \text{ failures} \quad (7-6)$$

where

$$(F_B)_{total} = \text{total BITE indications of failure, i.e., true failures plus false alarms, failures.}$$

$$\begin{aligned} F_{FA} &= (F_B)_{total}R_{FA}, \text{ expected false alarms} \\ &= (F_B)_{total}(0.05) \end{aligned} \quad (7-7)$$

where

$$R_{FA} = \text{false alarm rate of all BITE indications, \%}.$$

Since from Eq. 7-3  $(F_B)_{detect} = 45$ ,

$$\begin{aligned} (F_B)_{total} &= 45 + 0.05(F_B)_{total} \\ 0.95(F_B)_{total} &= 45 \\ (F_B)_{total} &= 47.37 \text{ failures.} \end{aligned}$$

7-4

Therefore, the number  $F_{FA}$  of false alarms is

$$\begin{aligned} F_{FA} &= (F_B)_{total} - (F_B)_{detect}, \\ &\text{false alarm indications.} \end{aligned} \quad (7-8)$$

Since from Eq. 7-3  $(F_B)_{detect} = 45$ ,

$$F_{FA} = 47.37 - 45 \approx 2 \text{ false alarm indications.}$$

6. Total corrective maintenance time  $(T_{LRU})_{total}$ , on the average, required to repair the BITE detected and isolated failures is

$$(T_{LRU})_{total} = F_{LRU}(MTTR)_B, \text{ h} \quad (7-9)$$

where

$$(MTTR)_B = \text{mean time to repair BITE detected and isolated failures, h.}$$

Since from Eq. 7-4  $F_{LRU} = 40$ ,

$$(T_{LRU})_{total} = 40(2) = 80 \text{ h.}$$

7. Total corrective maintenance time  $(T_{NB})_{total}$ , on the average, required to repair the remaining non-BITE detected and isolated failures  $F_{NB}$  is

$$(T_{NB})_{total} = F_{NB}(MTTR)_{NB}, \text{ h} \quad (7-10)$$

where

$$F_{NB} = F_T - F_{LRU}, \text{ failures.} \quad (7-11)$$

Therefore, since from Eq. 7-2  $F_T = 50$  and from Eq. 7-4  $F_{LRU} = 40$ ,

$$F_{NB} = 50 - 40 = 10$$

and

$$(T_{NB})_{total} = 10(5) = 50 \text{ h.}$$

8. Assume that manual, or non-BITE, maintenance time of 5 h is required to resolve each false alarm indication. Then the total non-BITE corrective maintenance time  $(T_{NB+FA})_{total}$ , on the average, is

$$(T_{NB+FA})_{total} = (T_{NB})_{total} + (T_{FA})_{total}, \text{ h} \quad (7-12)$$

where the total time  $(T_{FA})_{total}$  required to resolve the false alarm indications is

$$(T_{FA})_{total} = F_{FA}(MTTR)_{NB}, \text{ h.} \quad (7-13)$$

Since from Eq. 7-8  $F_{FA} = 2$  and from Eq. 7-11  $(T_{NB})_{total} = 50$ ,

$$(T_{FA})_{total} = 2(5) = 10 \text{ h}$$

and

$$(T_{NB+FA})_{total} = 50 + 10 = 60 \text{ h.}$$

9. Total corrective maintenance time  $T_{total}$ , on the average, expected, during  $TPI$ , is

$$T_{total} = (T_{LRU})_{total} + (T_{NB+FA})_{total}, \text{ h.} \quad (7-14)$$

Since from Eq. 7-9  $(T_{LRU})_{total} = 80$  and from Eq. 7-13  $(T_{NB+FA})_{total} = 60$ ,

$$T_{total} = 80 + 60 = 140 \text{ h.}$$

From Example 7-1 it is apparent that even with a high  $AFIC$  of 81%, the non-BITE-oriented corrective maintenance represents  $60/140 = 43\%$ —i.e.,  $(T_{BN})_{total}/T_{total}$ —of the total anticipated corrective maintenance hours. The example did not consider the impact of any scheduled maintenance since it is not associated with BITE. Also Example 7-1 has been greatly simplified in that it ignored BITE-addressable errors such as cable connectors. In this planning type of example, it was assumed that the BIT  $AFIC$  will be 81%. If, in fact, the  $AFIC$  is 81%, then  $80/140 = 57\%$ —i.e.,  $(TLRU)_{total}/T_{total}$ —of the maintenance effort will be oriented toward BITE detected and isolated failures. However, if the true  $AFIC$  is determined to be lower than 81%, it may be necessary to reevaluate the overall effectiveness of the entire maintenance and logistic programs as well as total mission effectiveness.

## 7-3 DIAGNOSTICS

### 7-3.1 GENERAL (Ref. 7)

Diagnostics refers to the functions performed and the techniques used in determining and isolating the cause of malfunctions in an operating system or in determining its operational status. The primary objective of the maintainability engineer in the field of diagnostics is an overall reduction of system downtime by providing a strategy for the rapid location of faults.

Observations from various case studies of materiel now in the inventory reveal that diagnostic system development is an immature discipline when compared to reliability or maintainability. One of the chief reasons is that there are no accepted definitions of requirements that are directly understandable and that can be related to field performance. Diagnostic tests also are less mature—although fault insertion tests can be diagnosed in the laboratory, they are poor predictors of field performance. A comparison of results from laboratory fault insertion tests and field operational tests for the F-16, APG-66 Fire Control Radar, is shown in Table 7-1 (Ref. 9). Table 7-1 indicates that a successful demonstration in a laboratory setting is no guarantee of success in the field. Demonstration by fault insertions is necessary, but not sufficient, to validate a diagnostic design.

Lack of knowledge in the diagnostic area presents a significant challenge to the developer to improve the diagnostics of current weapon systems and acquisition methods for improved diagnostics in future weapon systems. Where a mature diagnostic capability has been achieved in systems that required sophisticated techniques, it is obvious that success was no accident; success evolved as the direct result of a carefully defined process consisting of the following elements:

1. Planning
2. Management strategy
3. Motivation
4. Technical activity and innovation
5. Adequate funding that spanned system acquisition from the definition of requirements through deployment.

As indicated in par. 7-1, the user's requirements should address diagnostic capability in the larger context of the operational mission and environment as well as the support constraints of manpower, skill-level maintenance concept, deployment, and logistic burden. The requirements, constraints, environment, and economics should then drive the architecture of the system with diagnostics being one of the fundamental characteristics.

### 7-3.2 DESIGN NEEDS (Ref. 9)

In the area of design of diagnostic systems, case studies have identified the following design needs:

1. Strategies to minimize "cannot duplicate", "bench-checkd serviceable", "retest OK", and false alarm conditions
2. Techniques to maximize vertical testability. i.e., from system, to subsystem, to subassembly, to part level
3. Flexible diagnostic systems that will permit changes to be incorporated in diagnostic algorithms, displays, and tolerances with minimal hardware impact
4. Fault-free software development techniques
5. Techniques to enable more concurrent hardware and software development, and earlier integration of the two
6. Computer-aided engineering techniques for enhancing design for testability. Some techniques such as LOGMOD and STAMP may already be available to meet this need.
7. Experienced engineers who understand how to achieve good diagnostic techniques
8. Tools for predicting, measuring, and managing diagnostic designs
9. Better design practices such as the control of timing margins in high-speed circuits and systems.

### 7-3.3 DEVELOPMENT AND DEMONSTRATION TESTING (Ref. 9)

Case studies have shown that improvements in development and demonstration testing will aid in diagnostic development. The following guidelines have been suggested by the experts:

1. Use reliability and other test events as opportunities to discover problems with BITE performance. Envi-

**TABLE 7-1. TYPICAL FAULT INSERTION TEST RESULTS VERSUS FIELD RESULTS (Ref. 9)**

(A) Multiplex Bus Equipment

Measure of Effectiveness	Results		Rating	
	Fault Insertion Test	Field	Satisfying Contractual Requirements	As User Sees It
Fault Detection, %	90	49	Satisfactory	Deficient
Cannot Duplicate, %	---	45.6	--	Deficient
Fault Isolation, %	93	69	Satisfactory	Deficient
Retest Okay, %	---	25.8	-	Deficient

(B) Flight Control System Test (ST)/ Built-in Test (BIT)

Measure of Effectiveness	Results		Rating	
	Fault Insertion Test	Field	Satisfying Contractual Requirements	As User Sees It
Fault Detection, %	100	83	Excellent	Deficient
Cannot Duplicate, %	---	17		Deficient
Fault Isolation, %	92	73.6		Deficient
Retest Okay, %	---	20		Deficient

ronmental testing may be particularly useful for discovering false alarm indications such as induced intermittent and transients.

2. Increase the number of repair parts and the time budgeted in the laboratory to investigate diagnostic anomalies.

3. Expand the set of faults inserted.

4. Increase the allowable cost of demonstrations to include repair costs. This action will permit the insertion of a better cross section of faults.

5. Develop a library of computer simulation models to test BIT (hardware and software).

6. Adopt comparability analysis as a useful tool for identifying a realistic set of faults for insertion.

7. Develop improved demonstration techniques to predict diagnostic performance in the field.

Field maturation is essential to achieve inherent diagnostic potential. When a system is first fielded, it is common to find that not all the hardware and software provisions of the diagnostics have been fully implemented. In addition, the operational use patterns and the environment produce new failure modes and diagnostic indications. Unfortunately, these new indications which the BIT equipment may not deal with properly- are resolved by the judgment of operators and maintainers (who may not have been trained to deal with them) with the aid of technical data that may not have been developed to address them. Thus a structured diagnostic maturation effort must be resorted to for the purpose of bringing the

diagnostic capability to its full potential. The key features of successful programs should be used in structuring future diagnostic maturation efforts for complex equipment. Unless this is done, diagnostics, and BITE in particular, could be the weak link in the support chain (Ref. 10).

### 7-3.4 DIAGNOSTICS FOR MECHANICAL SYSTEMS

#### 7-3.4.1 Condition Monitoring of Mechanical Systems

Diagnostics, or "condition monitoring of mechanical systems", combines the measurement of performance and the detection of damage with the possibilities of prognostics to eliminate unnecessary and premature removal of system components. A proven technology base exists and a variety of successful demonstrations have been conducted that indicate reliability and readiness improvements can be obtained by application of this technology to current or future systems. Propulsion, transmission, and structural components are significant contributors to performance and readiness of weapon systems and platforms, and they provide the focal points for the study of condition monitoring of mechanical systems (Ref. 11).

Unlike some of the other technologies, the issues in the condition monitoring of mechanical systems center around the development of the following specific condition-monitoring technologies:

1. Techniques for the electrostatic monitoring of engines
2. Ultrasonic wear particle sensors
3. Advanced engine diagnostic technology
4. Integrated transmission monitoring
5. Structural testing
6. Computer program techniques for likeliness analysis (see par. 7-6.1).

These technologies need refinement, demonstration, and integration with automatic data processing equipment. Preliminary demonstrations have shown that each of the listed technologies has the potential to correct some of the defects in existing condition-monitoring technology. For example, the late consideration of condition monitoring in mechanical systems results in additional costs, weight penalties, and unnecessary false alarms. If properly incorporated into the initial design, these devices can mature with the system design, will minimize the weight penalty, and can reduce costs of the initial testing of the subsystem prior to production and fielding (Ref. 11).

Condition-monitoring techniques are being successfully applied to the T700 BLACK HAWK engine in the factory and in the field. Of particular value has been the engine history recorder for comparing the relative severity of field testing of engine operation with specification endurance test cycles. The engine chip detector has proven to be an effective means of detecting incipient oil-wetted part failures. Borescope inspection has also proven to be useful and easy to do in the factory and on the wing. Ground use of the diagnostic connector for troubleshooting has been effective even though the currently available test box is only a nonpowered resistance checker. Condition monitoring coupled with line-replaceable unit installation and rigging with no required adjustments contribute to the overall mission readiness of the T700 engine. As a result of the demonstrated reliability of the engine, only a 10-h inspection check, which is accomplished in 3 rein, and a periodic inspection performed at 500 flight-hour intervals, which can be performed on-wing in 1 h, are required (Ref. 12).

#### 7-3.4.2 Nondestructive Evaluation

Nondestructive evaluation methods have been valuable tools for maintenance for decades. During the past several years, however, work with these methods has shown outstanding promise for reducing maintenance costs, maintenance time, and manpower requirements and for eliminating operational hazards. A body of knowledge now exists of the benefits obtained from nondestructive testing technologies that could be successfully applied to tanks and rotary-wing aircraft. Examples of these technologies are (Ref. 11)

1. Automated ultrasonic inspection techniques for composites
2. Automated nondestructive testing of software
3. X-ray diffraction techniques for measuring residual stresses on torsion bars and track pins
4. Advanced techniques for weld monitoring.

## 7-3.5 DIAGNOSTIC TECHNIQUES

### 7-3.5.1 Importance

Incorrect diagnoses of failures can result in the unnecessary removal of serviceable parts and repetitive maintenance actions, both of which reduce the efficiency of maintenance actions by increasing costs and decreasing system availability. For example (Ref. 13), repetitive maintenance actions on helicopters were found to occur at a rate of 0.32 per flight hour and “diagnostics—including test equipment, troubleshooting, and standard maintenance practices—were identified as causing over 50% of all repetitive maintenance actions”. If automatic monitoring and/or alarms had been provided instead of relying on operator sensing, it is estimated that equipment nonavailability due to maintenance could have been reduced by as much as 25% per action. Obviously, the lessons learned were introduced into the design of the T700 BLACK HAWK engine (see par. 7-3.4.1). Although these data are relative to helicopter maintenance, it is reasonable to assume similar data exist for other materiel categories and thus illustrate the effectiveness of improved diagnostic techniques.

The time required to locate a fault is a function of techniques such as integrated performance monitoring and maintenance tests. On-line monitoring of performance is designed into most Army equipment—for example, an automotive vehicle in which the temperature of the engine coolant, oil pressure, fuel level, and battery or alternator output are monitored constantly. The automotive vehicle also serves as an example for the conduct of familiar maintenance tests such as checking fuel, oil, coolant, battery, and other fluid levels before driving the vehicle. These simple performance indications and maintenance procedures usually localize a fault to one or several components. Diagnostic techniques take advantage of the gross localization aids to isolate the component that requires repair or replacement.

Trying to locate a fault without proper diagnostic techniques usually requires more time than any other task in the maintenance cycle. This is because trial-and-error troubleshooting often results in an erroneous outcome; therefore, the process must be prolonged or delayed and repeated. A simple illustration of this fact is the cost associated with the repair of a TV set—unless the picture tube is replaced, 90% of the charge is for labor to determine the faulty component. Accurate automated maintenance provisions can significantly reduce the frequency of errors through their consistent logic and their avoidance of human volition and training problems. Artificial intelligence and expert systems (see par. 7-3.5.3) can contribute to automated diagnostic processes.

### 7-3.5.2 Types of Diagnostic Techniques

All diagnostic techniques can essentially be divided into three broad categories, i.e., those employing

1. Logic flow
2. Automatic test equipment

## DOD-HDBK-791(AM)

### 3. Built-in test equipment.

Each of these categories is discussed in the paragraphs that follow.

#### 7-3.5.2.1 Logic Flow

Logic flow—a troubleshooting road map is an outline of the sequence to be followed in the event of a system failure; it is essentially a manual procedure. As a maintenance aid for fault isolation, it provides a step-by-step description of the questions to be asked, tests to be conducted, and continued sequential localization paths to be followed depending on test results. The “roads” lead from generalized localization to specific fault localization. Specific data required by the technician to enable him to localize a fault will allow him to accept or reject each component tested as the source of the trouble. For example, an overheated engine can result from coolant leaks, low coolant pump pressure, and constricted passages. Measurement of fluid flow and temperature at strategic points in the cooling system can aid the technician in eliminating the source of the fault—radiator, hoses, and engine—and zero in on a pump leak or failure. A check-out of the system after repair usually requires a repeat of all the checks used for localization.

In electronic systems, three data flow patterns are generally of diagnostic interest, i.e.,

1. Simple series pattern
2. Complex—series-parallel—pattern
3. Loop pattern.

In the simple series pattern the data flow goes through one element at a time, and the element that stands between a good signal and a bad one is the fault source. In the complex pattern, places exist where the data flow fans out along parallel paths. In this case the fault may be localized to a parallel set, and further tests must be conducted to locate the faulty element of the set. In the loop pattern, part of the flow returns to an element as feedback. In this case a fault in one loop element can make it more difficult to distinguish between the element causing the fault and elements simply reacting to the faulty signal.

Logic flow diagrams are very important in designing computer software used with ATE. The programmer must match the logic flow of his software with the logic flow of the hardware being tested and with various hardware fault modes and combinations of some of the more common modes. The programmer must take precautions to code the software for all conceivable circumstances. For example, under some fault circumstances one of the tests may prematurely transfer control to the end of the software loop. Adequate design of test software requires that the programmer strive for reliability and that he thoroughly test his program before releasing it for use.

The sequence of repair in a flowchart should recommend corrective actions according to

1. Probability of failure
2. Accessibility and/or simplicity of repair

but not necessarily in the order given—i.e., even if it is unlikely that Part A failed, if Part A is readily accessible, it might be advantageous to check Part A first.

A logic flow for a tracking radar is discussed in par. 7-5.5 and is illustrated in Fig. 7-3.

#### 7-3.5.2.2 Automatic Test Equipment

Automatic test equipment (ATE) is defined as equipment that is designed to conduct automatically the analysis of functional or static parameters and to evaluate the degree of the performance degradation of the unit under test (UUT), and it may be used to perform fault isolation of the UUT malfunction (Ref. 14). The decision making, control, or evaluative functions are conducted with minimum reliance on human intervention and usually are done under computer control. ATE is used to detect and isolate a fault automatically and to check out the system following a maintenance action. ATF is separate from the unit under test and is used primarily at the intermediate and depot maintenance levels—the UUT is brought to the ATE or the ATE is brought to the UUT. If the use of ATF is contemplated, a trade-off analysis must be performed early in the system acquisition process to determine the value of the automatic test features in relationship to operational effectiveness, logistics, maintenance effectiveness, and life cycle costs. The interdependent parameters of quantity, location, and reliability of ATE can be determined by using a generalized cost-effectiveness model. ATE is costly and, if not properly integrated into the overall system, may introduce more reliability and maintenance problems than it solves. However, the costs associated with the design and procurement of ATF are not the complete story. If the ATE results cannot be confidently relied upon, false alarms can result in the disposal of serviceable equipment and in reduced equipment availability resulting from unnecessary maintenance. ATE—when it is used properly and when it can be relied upon to yield an accurate diagnosis—will reduce maintenance time and the skill level and number of maintenance personnel and will increase the availability of the system.

Selection of test features to be incorporated into an ATE system should be based on the following considerations:

1. *Test Function for Purpose.* Is ATE to enhance maintainability, optimize performance of the system, monitor operational readiness, improve system availability, or is it a combination of these purposes?

2. *Testing Modes.* Will ATE be used on-line with the system operating, on-line with the system under test, or off-line?

3. *Level for Defection.* At which level will ATE detect a fault or malfunction—equipment, subsystem, or module?

4. *Degree of Fault Isolation.* At which level will ATE isolate a fault—equipment, subsystem, groups of replaceable modules, modules, line-replaceable units, or individual circuits?

System level design requirements for the automatic test features should be specified quantitatively and defined quantitatively in the system specification in terms of fail-

ure detectability; false alarm rate; degree of fault isolation desired; fail-safe provisions; and the reliability and maintainability of the sensors, interface hardware, and the ATE itself. Some general-purpose ATE now exist, e.g., AN/USM-410 (EQUATE) and GENRAD. Accordingly, new systems, where apropos, should be designed to be compatible with these ATE systems. Artificial intelligence, described in par. 7-3.5.3, may be used beneficially in the design of ATE.

### 7-3.5.2.3 Built-In Test Equipment

Built-in test (BIT) is defined as an integral capability of the mission equipment that provides an on-board, automated test capability to detect, diagnose, or isolate system failures (Ref. 14). The fault detection and, possibly, isolation capability are used for periodic or continuous monitoring of the operating condition of a system and for observation and, possibly, diagnosis as a prelude to maintenance. BIT may be of several types (Ref. 14), i.e.,

1. *Active BIT*. A type that is temporarily disruptive to the prime system operation through the introduction of test stimuli into the system.

2. *Continuous BIT*. A type that continually monitors system operation for errors. Examples include parity—maintenance of a sameness of level or count, i.e., keeping the same number of binary ones in a computer word and thus be able to perform a check based on an even or odd number for all words under examination—and other error-detecting codes.

3. *Initiated BIT*. A type that is executed only after the occurrence of an external event such as an action by an operator.

4. *Passive BIT*. A type that is nondisruptive and noninterfering to the prime system.

5. *Periodic BIT*. A type that is initiated at some frequency. An example is BIT software executing during planned processor idle time.

6. *Turn-On BIT*. A specific type of initiated BIT that is exercised each time power is applied to the unit or system.

These definitions indicate that BIT equipment may be automatically or manually triggered.

A BIT capability, as a means of attaining the required level of failure detection capability, must be relied upon as an automatic diagnostic tool because of the ever-increasing complexity of modern weapon systems. The need for BIT is driven by operational availability requirements that do not permit the lengthy mean-time-to-repair associated with detecting and isolating failure modes in microcircuit technology equipment. Since BIT equipment operates within the prime system and at the same functional speed, it has the capability to detect and isolate failures that conventional test equipment and techniques could not provide. A well-designed BIT system can reduce substantially the need for highly trained field and intermediate level maintenance personnel by permitting less skilled personnel to locate failures and send them to centralized intermediate and depot repair facilities equipped to diagnose and repair defective hardware.

A BIT capability is not a comprehensive solution to all system maintenance problems, but rather a necessary tool to deal with the complexity of modern electronic systems. Despite the advantages of BIT to provide a fast troubleshooting capability, it does have disadvantages. The primary disadvantage is that the BIT test elements must be made an integral part of the prime unit. This addition increases size, weight, complexity, and cost and imposes an extra maintenance burden when the BITE fails. If a BIT capability is to be employed, the decision must be made in the early stage of development and the BITE must mature together with the prime equipment. Some of the basic BIT decisions to be made early in system design are whether testing should be manual or automatic and whether testing should occur without interrupting the normal operation of the system or should be programmed at intervals when the prime system can be released from its operational commitment to conduct the test. Other considerations relative to the selection of features to be incorporated into BIT equipment are similar to those described for ATE in par. 7-3.5.2.2. Artificial intelligence, described in par. 7-3.5.3, may be used beneficially in the design of BITE.

Par. 7-6.2 provides an example of how BITE has been applied to an advanced attack helicopter to solve a critical diagnostic problem.

### 7-3.5.3 Artificial Intelligence

Artificial intelligence (AI) is a field aimed at pursuing the possibility that a computer can be made to behave in a manner that humans recognize as intelligent behavior in each other (Ref. 15). In a more restrictive sense AI could be considered a study of techniques for more effective use of digital computers through improved programming techniques. A further extension of the AI concept is the development of an expert system, i.e., an intelligent computer system that uses knowledge and inference procedures to solve problems that are difficult enough to require significant human expertise in their solution (Ref. 15). The consensus of experts—resulting from case studies of BIT and ATE associated with existing weapon systems—is, that despite the abundance of automated diagnostic aids and trainers, there must be radical changes in maintainability technology in order to achieve significant improvement in maintenance procedures (Ref. 10). AI technology lends itself to the reduction of human workload in complex weapon systems and to the enhancement of training and maintenance and thus enables lower skill level technicians to maintain complex defense systems more efficiently. For example, AI technology could be applied to the design of very large-scale integrated circuits (VLSIC) and very high-speed integrated circuits (VHSIC) to design in testability and fault tolerance (Ref. 10). AI and expert system applications are not confined exclusively to electronic systems. An example of the application of an expert system to a mechanical system is that developed by the General Electric Company to assist railroad maintenance personnel in the repair of GE's diesel-electric locomotives. The program is referred to as DELTA (Diesel-Electric Locomotive Troubleshooting

## DOD-HDBK-791(AM)

Aid) (Ref. 15). Contracts were awarded by the Army in 1985 for the development of AI technology to assist in the troubleshooting and maintenance of helicopters and related aviation systems. Specifically, AI is being harnessed to diagnostic test equipment for the AH-64 APACHE attack helicopter. Software developed using AI will be applied to a device referred to as an “intelligent fault locator”—a van-mounted computer that can service helicopters on a flight line or in the field. The system enables crew chiefs to enter a fault description into a computer, which will then take the crew chief through a series of checks that will identify the problem.

### 7-4 FUNCTIONAL TESTS

#### 7-4.1 TYPES

Functional testing performed with diagnostic equipment is for the purpose of

1. *Fault Localization, Isolation, and Prediction.*

The identification of replaceable units or components that have caused a known fault and, where practicable, an indication of an impending fault

2. *Verification Testing.* Testing performed to insure readiness before the start of the mission and after maintenance

3. *Testing for Hidden Faults.* Testing of diagnostic monitors to insure readiness.  
Each of these functions is discussed further in the paragraphs that follow.

##### 7-4.1.1 Fault Localization, Isolation, and Prediction

The primary test functions include fault detection, fault localization or isolation, and fault prediction. The desired function must be defined and its resulting complexity considered in relation to the equipment being tested. The maintainability plan should establish whether the test function is to be fault detection alone; fault detection and isolation; or fault detection, then isolation; and, when practicable, prediction. Neither the inability of the automatic test feature to predict impending failure should prevent it from being useful in isolating the fault once a malfunction has occurred nor should failure of the automatic test feature to isolate a fault prevent it from being useful for detecting the fault and signifying a “down-for-repair” condition. In general, fault isolation should be consistent with the maintainability plan and should not go below the cost-effective level of detection.

##### 7-4.1.2 Verification Testing

Testing frequently is used to verify the performance or condition of the system when no fault is present or after fault correction. For example, most missiles are checked for proper operation prior to firing; normally the same test equipment is used to verify that the missile is operating properly following the replacement of an unserviceable component. The test designer must decide whether stimuli—the inputs or signals from the test set to the item

being tested to allow simulation of its operation under mission conditions—are required to interrogate the system. The stimuli must be realistic and controlled—e.g., if current is introduced into a system to check circuit continuity, care must be exercised to insure that the magnitude of the current will not inadvertently activate sensitive components. Accordingly, stimuli application must be carefully considered relative to the functions exercised in the item under test. The selection of the test set stimuli, if required, must be made at the same time the transducers are selected.

##### 7-4.1.3 Testing for Hidden Faults

Hidden function faults are failures within the test equipment or condition monitors, which would prevent the detection of a system component or failure for operation readiness assessment or during a mission. A premission test of the monitor must be designed into the test equipment if detection of the system or component failure is critical.

#### 7-4.2 PERCENTAGE OF FAILURES DETECTABLE

Diagnostic test features must themselves be the subject to determine that a specified percentage of component or system failures can be detected by the techniques and test equipment employed. The basis for this verification is the documentation developed during the equipment testability analysis (see par. 7-2.2). The test equipment designer initially verifies analytically that sufficient failure modes will be detected by the test features to meet the percentage of troubleshooting requirements. The actual testing to substantiate this analysis usually is done on a random sampling basis for complex equipment. i.e., a certain fraction of the failure modes are identified randomly. These modes are then simulated in the prime equipment to determine whether the test features detect and isolate the source of failure. The results of the test sampling are then used to accept or reject the hypothesis that the test features meet the specified requirements. Caution must be exercised, however, because the laboratory results may not be consistent with those experienced in the field (see Table 7-1).

### 7-5 DIAGNOSTIC EQUIPMENT DESIGN CONSIDERATIONS

Design considerations for diagnostic equipment are a function of many parameters:

1. Type of equipment to be used and factors leading to this decision
2. Diagnostic software considerations
3. Test point identification
4. Test sequence considerations
5. Selection of transducer or sensor
6. Stimuli selection
7. Output format
8. Diagram use.

Each of the parameters together with their application is discussed in the pars, 7-5.3 through 7-5.10.

### 7-5.1 CLASSIFICATION

In this discussion it is assumed that the maintainability plan has dictated that the test procedures and equipment must be automated, i.e., manual troubleshooting employing off-the-shelf devices will not suffice. Thus diagnostic equipment can be classified as generalized or specialized. The decision depends on whether the test equipment will serve several subsystems of the same systems or other similar systems or whether it will be unique to the subsystem or system under design. If either a generalized or specialized test system will satisfy the time restraints of the maintainability plan, then the decision should be measured in relationship to

1. Newly furnished capabilities or techniques
2. Efficiency of operation
3. Effect on operating system(s) serviced, i.e., can the on-line system be conducted, or must one system wait while another is being tested?
4. Effect on skill level, number, and type of technicians required
5. Total cost implications.

### 7-5.2 SNEAK CIRCUITS (Ref. 16)

To cope with the challenge of maintaining complex weapon systems, the maintainability engineer is forced to rely on the increasing use of BITE and ATE. Their use—since the equipment itself embodies electrical hardware or software systems—may introduce sneak circuits into the prime system or the sneak circuit may be indigenous to the test equipment. A sneak circuit is an unexpected path or logic flow within a system which, under certain conditions, can initiate an undesired function or inhibit a desired function. The path may consist of hardware, software, operator actions, or combinations of these factors. Sneak circuits are not the result of hardware failure but are latent conditions inadvertently designed into the system or coded into the software program, which can cause it to malfunction under certain conditions. Sneak circuit analysis is the analytical technique used to identify sneak circuits in systems.

The causes of sneak circuits are system complexity, system changes, and user operations. Hardware complexity results in numerous interfaces between the prime system and the BITE or ATE, which may obscure the intended function or produce unintended functions. The effects of even a minor wiring or software change to a specific component may result in undesired system operations. Also a system that is relatively sneak free can be made to circumvent desired functions or generate undesired functions as a consequence of improper test operations or procedures, e.g., a test performed out of sequence. The identification of a sneak circuit, however, does not always indicate an undesirable condition; in fact, some have been used to accomplish tasks when other circuitry has failed (Ref. 17). The implications of a sneak circuit, therefore, must be explored and its impact on the circuit function determined before any corrective action is taken.

Categories of sneak circuits are defined as

1. *Sneak Paths.* Unexpected paths along which cur-

rent, energy, or logical sequence flow in an unintended direction or to an unintended destination

2. *Sneak Timing.* A situation in which events occur in an unexpected or conflicting sequence

3. *Sneak Indication.* An ambiguous or false display of system operating condition that may result in an operator's taking an undesired action

4. *Sneak Label.* incorrectly labeled system function—e.g., system inputs, controls, or displays that may cause an operator or technician to apply an incorrect stimulus.

Sneak circuit analysis requires a lot of computer time and may be expensive. Therefore, the analysis should be considered for components—hardware and software—that are critical to mission success and safety. However, if test equipment is yielding spurious information, i.e., an excessive number of “cannot duplicates”, “retest OKs”, bench-checked serviceable, or false alarms—sneak circuit analysis may reveal the source or cause of the anomalies.

### 7-5.3 BUILT-IN TEST EQUIPMENT VERSUS AUTOMATIC TEST EQUIPMENT

BITE is built-in, integral with the subsystem or system to be tested. ATE is not integral with the subsystem or system; ATE must be moved to the test item or the item must be moved to the ATE. Some of the factors that must be considered in choosing between BITE and ATE are

1. *Technicians' Skill Level.* In general, a technician will require a higher skill level to use ATE because detection is not usually of the simple “go” or “no go” type. The technician will have to hook up the ATE, apply selective stimuli, and perhaps interpret readouts.

2. *Physical Factors.* To minimize weight and size requirements, it may be necessary to employ ATE; this is particularly important in airborne systems. However, restricted access to the item to be tested would favor BIT equipment.

3. *Maintainability and Reliability.* These attributes of the system must be considered in the decision process. BITE could impose another element into an already overly complex system and thus detract from the overall reliability of the system. Since it is present in the system, BITE may increase the maintenance load on the system—downtime for BITE maintenance reduces the availability of the system. On the other hand, since specific BITE will be less complex than multipurpose ATE, BITE should require less maintenance and be more reliable.

4. *Logistics.* The numerous pieces of BITE—with its unique purpose and function—will add to the number of repair parts required together with an increased need for operational and maintenance manuals. A centralized ATE that consolidates many test functions reduces the logistic burden.

5. *Frequency of Application.* If a test must be conducted frequently to determine the operational readiness or status of a system—particularly if the test must be conducted on-line—BITE would be the likely candidate. The immediate nonavailability, movement, and the required hookup could render ATE unmanageable.

## DOD-HDBK-791(AM)

6. *Cost.* Cost is always a factor in any trade-off study of BITE versus ATE. It is generally more cost-effective to provide specialized diagnostics for BITE and to provide general-purpose diagnostics for ATE.

### 7-5.4 DIAGNOSTIC SOFTWARE

Diagnostic software designers should consider

1. *Structured Programming.* Structured programming—a set of programming principles that produces software modules that are easily understood and maintained—should be used. In applying the programming, unconditional reverse transfers are to be avoided to eliminate looping transfers.

2. *Language Selection.* Higher level languages, approved by the Army, may be necessary to develop computer programs that simulate human behavior or to employ artificial intelligence or expert systems (see par. 7-3.5.3) in problem solving. The higher level languages also are more readily understandable, but the lower level languages (assembler) are often more efficient. ATLAS (Abbreviated Test Language for All Systems) is an example of a high-level directed standard test language whose major features are (Ref. 14)

a. Standard testing terminology to reduce erroneous interpretations

b. UUT-oriented test statements to increase portability, i.e., ability to be used with different test equipment configurations.

3. *Debugging.* The debugging of diagnostic software can be a lengthy and tedious process because of the numerous ways in which fault sources can occur and

because some sources appear infrequently but have serious consequences when they do occur. Thus it is important that the diagnostic system mature with the development of the major system, i.e., being employed throughout the phases of system development and not when the prime system is released to troops.

4. *Automatic Inspection, Diagnostic, and Prognostic System (AIDAPS) Software.* AIDAPS software resulting from various contracts have resulted in developing diagnostic computer programs that can be transferred from one application to another (Ref. 18).

### 7-5.5 TEST POINT IDENTIFICATION

The identification of test points involves the following steps in the order indicated:

1. List system parameters to be measured.

2. List the output signals that, if present and within tolerance, would indicate that the system is in normal operating condition.

3. Identify internal functions that could cause the system output signal to fail and, therefore, should be monitored.

4. Decide on required test points and their locations. Each of the selected test points with its output signal should be evaluated for its compatibility with the diagnostic technique—manual, BIT, or ATE—to determine those signals adaptable to direct measurement and those requiring signal conditioning via a transducer.

Fig. 7-1 (Ref. 19) depicts a simplified example of a test

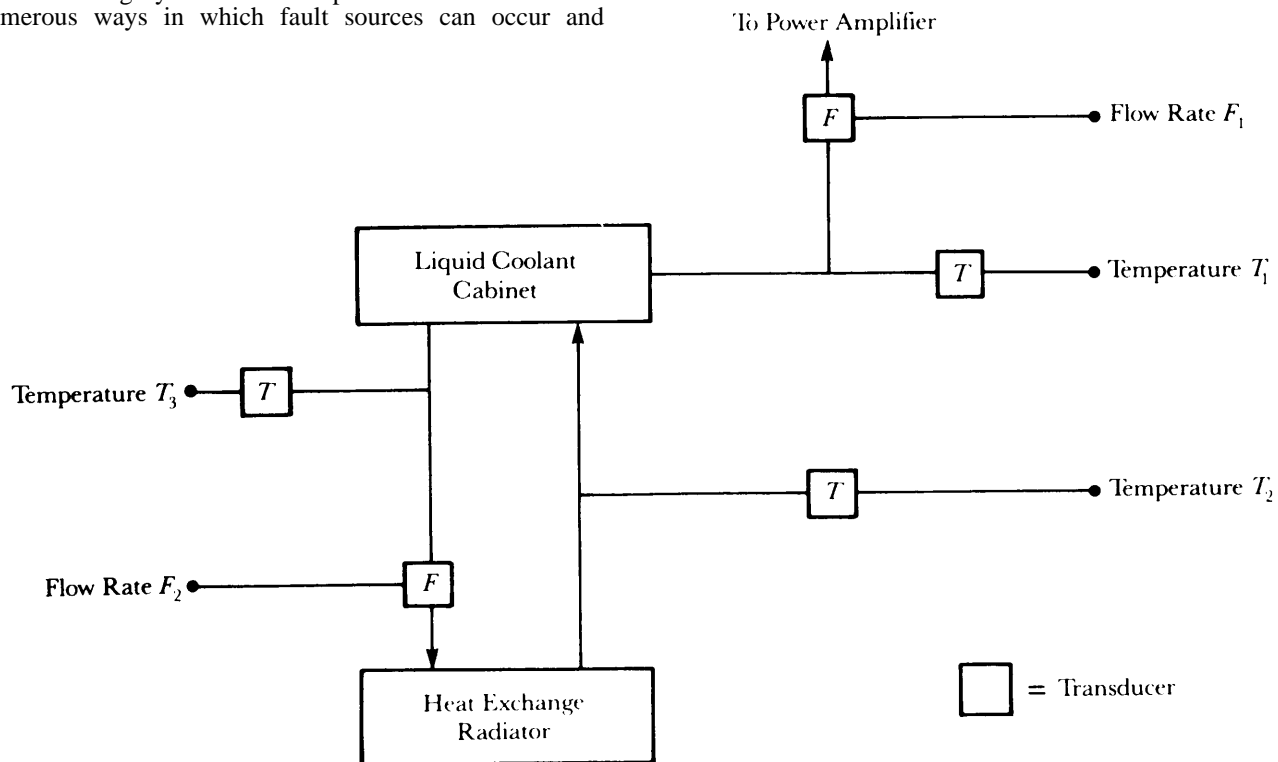


Figure 7-1. Liquid Coolant Subsystem Showing Transducers and Parameters of Interest (Ref. 19)

point selection process for a liquid coolant subsystem. Apply the guide for test point selection previously stated:

1. *Step 1.* Output parameters to be measured are temperature and flow rate.
2. *Step 2.* Output reading signals are
  - a. Specific temperatures plus tolerance, i.e.,  $T_i \pm t$ , degrees
  - b. Specific flow rate  $F_i$ , i.e., meters per second
3. *Step 3.* Internal functions that could cause the output signal to fail are
  - a. Coolant loss or reduced flow rate between
    - (1) Cabinet and radiator
    - (2) Radiator and cabinet
    - (3) Cabinet and power amplifier
  - b. Coolant temperature rise due to defective radiator
  - c. Temperature rise due to defective liquid coolant cabinet.
4. *Step 4.* To monitor the parameter and fault conditions, test points must be located
  - a. Between cabinet and radiator, both inflow and outflow, for temperature and flow rate
  - b. Between cabinet and power amplifier for temperature and flow rate.

To satisfy these locations and conditions, three temperature transducers and two flow rate transducers were chosen for the selected test locations. The transducer outputs were examined and found to be compatible with the test equipment. These points will produce stable voltage outputs with the desired time constants to provide accurate real-time readouts of the parameters that govern the system.

**7-5.6 TEST SEQUENCE CONSIDERATIONS**

Before fixing the diagnostic plan and its associated test equipment, it is necessary to determine a logical test sequence to be followed in the event of system failure. The analysis should reveal

1. Sequence or order of test
2. System or function to be tested
3. Prior tests required for measurement

4. System or function required for test
5. Parameters to be measured
6. Processing required for interpretation.

Approaches for implementing the diagnostic analysis are

1. First, test those components or units—power supplies, power amplifiers, and high-voltage modulators—known to exhibit the highest failure rate. Table 7-2 illustrates this procedure.

2. Second, test the system function by function in a sequence corresponding to the normal flow of signals through the system. This approach, though frequently time-consuming, is more logical and consequently more easily learned by maintenance personnel.

If testing is to be fully automatic, the difference in diagnostic time between the two approaches is negligible.

The complexity of the automatic system usually can be reduced greatly if self-isolating units, i.e., those units of a system with a BIT capability, are scanned before initiating a fault isolation procedure. The diagnostics associated with the prime system can be further simplified by grouping components of like functions into a self-isolating module. If the module is not of the throwaway type, the BIT equipment output must be compatible with the ATE at the intermediate or depot level for further diagnostics and repair. The self-contained concept is illustrated in the test sequence shown in Fig. 7-2 (Ref. 19) for the liquid coolant subsystem depicted in Fig. 7-1.

The example test sequence of Fig. 7-2 begins with a determination of whether the coolant temperature  $T_i$  is below the established maximum  $T_{max}$ , and whether the coolant flow  $F_i$  exceeds the specified minimum value  $F_{min}$ . When both answers are affirmative, the test equipment will indicate that the system is functioning properly. However, if  $T_i > T_{max}$ , a test of the heat exchange radiator input temperature  $T_3$  and output temperature  $T_2$  must be made. If  $T_2$  and  $T_3$  are within the specified range, the fault must be in the coolant cabinet. If  $T_2$  and  $T_3$  are not within specified range and the flow rate  $F_2$  into the radiator is adequate, then the heat exchange radiator is suspect. If the flow rate  $F_1$  into the power amplifier is not adequate,

**TABLE 7-2. TYPICAL TEST SEQUENCE (Ref. 19)**

Test No.	System Function To Be Tested	Prior Tests Required for Measurement	System Function Required for Test	Parameters Measured	Processing Required for Interpretation
1	Power Supply 1	None	Power On	Voltage	None
2	Power Supply 2	None	Power On	Voltage	Filter; divide by 10
3	Oscillator Output	None	Transmitting	Level of RF	Detect and amplify
4	Oscillator Frequency	None	Transmitting	Frequency	Gate counter with system synchronized
5	Amplifier Gain	Test 3	Transmitting	Level of RF	Detect and amplify; compare to Test 3
6	Output Noise	None	Transmitting Noise Test	Level of RF	Detect and amplify; compare to Test 5

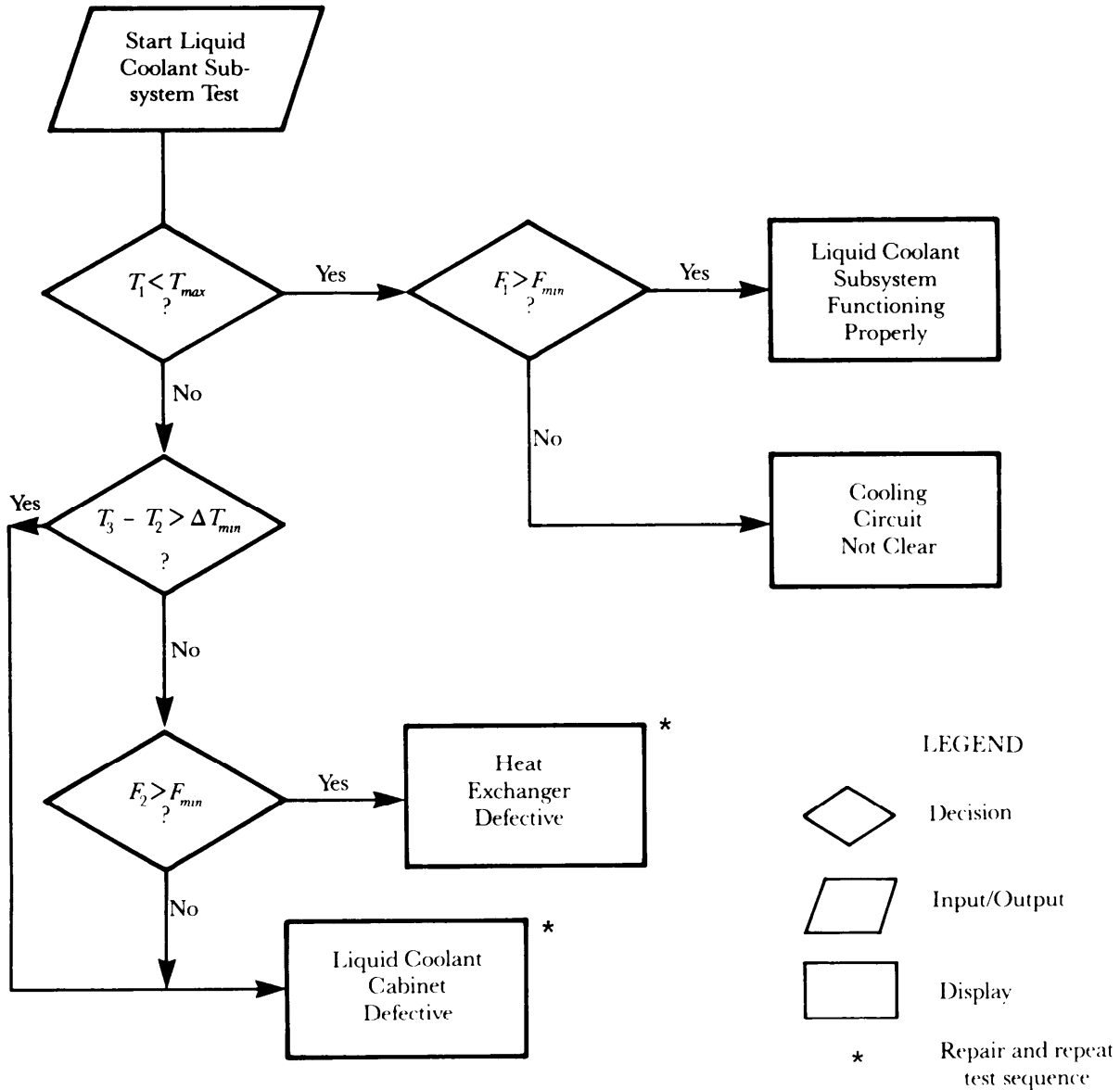


Figure 7-2. Test Sequence for Liquid Coolant Subsystem (Ref. 19)

the flow in the closed loop system is being blocked. Since there are no pressure differentials built into the system, manual procedures must be used for fault isolation.

A possible sequence for the maintenance testing of a track radar transmitter is shown in Fig. 7-3 (Ref. 19). The logic shown in Fig. 7-3 is illustrative only and is not intended to be complete. Detailed design of the sensors and equipment to measure pulse shape, frequency spectrum, and output products is a complex task. The six parameters—Power Supplies 1 and 2, oscillator output and frequency, amplifier phase, and noise output are tested in rapid succession. If a failure is detected, the self-isolating units are scanned first for probability failure indication. If none is detected, the particular failure logic is followed to isolate the failed unit. This method, i.e., progressing from failure indication to the survey of self-

isolating units and then to a specific failure logic, usually permits the design of less complex test equipment. The test sequence should be initiated by an internal clock to synchronize the steps and insure that required outputs are available when required for further sequence decisions. The other circuitry would be conventional logic circuitry, threshold detectors, sample and hold circuits, or simple analog circuits.

If a centralized automatic test system is used, the test sequence is usually computer controlled and thus requires that the programs be developed in close coordination with engineers responsible for design of the automatic test system. Similarly, changes to the test sequence necessitated by hardware changes are implemented by modification to the test program structured programming simplifies the required changes.



## DOD-HDBK-791(AM)

The system designer responsible for the automatic test function must consider the use environment when establishing the limits and thresholds for the parameters to be measured; this will insure that only true malfunctions are isolated. For example, if a stabilized inertial tank platform is being checked in a laboratory, the parameters being monitored would be stable and noise free. In the true tank environment, however, the same stabilized platform would experience tank motion and gyroscopic torquing, which would result in less stable parameters in a noisier background.

As a general guideline, the test designer should provide for all data manipulation within the test equipment to minimize the number of arithmetic operations required of test personnel. For example, if power is the measured parameter, the technician should not be required to read the voltage and current—and then multiply the two parameters—to determine power.

### 7-5.7 SELECTION OF TRANSDUCER OR SENSOR

When the parameters to be tested can be readily measured without conversion, e.g., voltage, they do not require parameter modification by a transducer. A parameter, such as electric current, can be transduced by means of a transformer and a known resistance to a desired voltage. However, temperature, strain, vibration, pressure, and power parameters require more sophisticated transducers. The selection of transducers is a task requiring knowledge of measurement requirements and transducer response characteristics. The five characteristics of transducers that are of particular interest to the maintainability engineer are

1. *Stability*. The ability to produce a constant output for constant input within a given time constant
2. *Repeatability*. The ability to duplicate the output after a change in input and then return to the previous value
3. *Procurability*. The ability to be procured in volume on the open market
4. *Calibration*. Should not be required except as a simple, scheduled, preventive maintenance task
5. *Output*. Should be amenable to multiplexing when the feature will simplify data transmittal; transducer impedance should be low enough to prevent noise coupling.

The electronics associated with many transducers consists of a bridge circuit in which the transducer is one leg of the bridge. The output voltage is then the voltage required to balance the bridge. A useful secondary output from such a circuit is the null voltage, i.e., the minimum output of a circuit as a function of an adjusting device. Although it is not good design practice to sense a “no reading” value, this bridge null voltage can validate the output as well as provide a point at which to begin fault isolation within the automatic test system. The transducers required to implement the logic of Fig. 7-2, for example, may vary from simple temperature transducers to complex subsystems. The measurement of phase noise could require a phase-to-amplitude modulation (P/AM)

conversion and then a determination of the AM level, which results in a multistage transducer.

A synchronized detection, sample, and hold device is required to monitor the radio frequency (RF) levels in the example. A common circuit for all these functions, with appropriate attenuation to account for all stages of amplification, would reduce the number of different transducers and simplify calibration.

### 7-5.8 STIMULI SELECTION

Stimuli are the inputs or signals furnished by the test system to the UUT to allow simulation of its operation. The selection of the test set stimuli must be made simultaneously with transducer selection to insure that the type and magnitude of the stimulus are compatible with the prime system. For example, if the stimuli introduced is an electric current to check circuit continuity, the magnitude of the current must be limited to avoid the unwanted operation or activation of a circuit component.

The application of the stimuli also must be carefully considered relative to the functions exercised in the UUT. For example, in the track radar it is desirable to know whether the radar is operating within specified performance limits. This information can be provided by introducing an RF pulse into the antenna immediately after the radar pulse at a time when the normal radar return is not expected. This test pulse would then be processed and recovered by a special gate in the video circuit and tested for amplitude and delay. Although this example procedure would test a major portion of the radar, it would not test the status or dynamic characteristic of the ranging circuitry or transmitter synchronization, both of which are vital to the satisfactory operation of the radar. A second test step should be introduced into the logic to assess these functions. In the track radar transmitter example, normal signal generation and pulse sources are used to relieve the need for auxiliary stimulus sources. This enhances the simplicity of the automatic test circuitry.

### 7-5.9 OUTPUT FORMAT

The output of the test equipment may take various forms—from the simple to the complex—e.g., “go”/“no go” light, meter reading or indication, analog display, or computer-generated printout. Regardless of the form, the readout must be both readable and understandable to the user. Consider the elementary case of a single meter used to display the readout from various inputs; the reader should not be required to introduce a scale factor to interpret correctly the meter readout from different sources. This practice can result in confusion or errors. The display or readout format may be dictated by the criticality of the data and the sampling rate. To assure crew safety and/or mission success, it may be necessary to sample data at the microsecond or nanosecond rate; in this case an analog display of the parameters indicating system status would be appropriate. The contribution to the system failure probability of latent faults, near coincident faults, fault coverage, and fault recovery times all will determine sample rate and output form.

If a printout or permanent record is generated by the test equipment, the record should be easily readable with a minimum of interpretation. Structure the software so that the parameters or components are identified by name, rather than a numerical code. The output also should be easy to reproduce i.e., avoid nonreproducible ink colors, odd-sized output forms, and punched cards or tape. Where the output data from one test system becomes the input data to a second test system, insure that the software programs and language are compatible. A data translation process is costly and subject to error. Moreover, data translation becomes impractical if the data must be translated in real time.

As indicated in Fig. 7-3, the output consists of several displays. A printout of the unit failures, with time and date markings, may be desirable if the size of the system were large enough to justify the added complexity. The printouts would provide audit trails of system and component reliability and would serve as a basis for inventory control and to support warranty claims. Power output and noise level in this example would be recorded or read from a meter at regular intervals.

### 7-5.10 DIAGRAMS

Previous paragraphs have provided guidance to the designer of test equipment to assist him in establishing diagnostic features that achieve the maintainability objectives that are compatible with the system being tested. The fact that an automatic test system might be fashionable should not be the deciding factor in pursuing this approach the complexity of the prime system, reliability of the system components and test equipment, and cost must enter into the decision. To facilitate the technician's task regardless of whether the test system selected is manual, BIT, and/or ATE—maximum use of block diagrams, flow diagrams, schematics, logic diagrams, and front panel layouts should be developed to assist with the necessary measuring, switching, and control circuits.

## 7-6 EXAMPLES

Three examples are presented

1. likelihood Analysis Computer Program
2. Advanced Attack Helicopter
3. T700 Gas Turbine Engine

which illustrate the applications of the design considerations presented in par. 7-5.

### 7-6.1 LIKELIHOOD ANALYSIS COMPUTER PROGRAM

The application of the state-of-the-art diagnostics is not limited exclusively to electronic components and associated circuitry; techniques have been developed for mechanical systems (see par. 7-3.4). one of the important diagnostic techniques resulting from Ref. 20 was the Likelihood Analysis Computer Program which detects differences in vibration signatures between rotating parts that are operating satisfactorily and those that have a fault that signals impending failure. Under the AIDAPS Program, vibration signature data for gearboxes, transmis-

sions, and similar rotating items were developed. The test data were gathered for helicopters, but the principles, diagnostic techniques, and software can be adapted to Army vehicles in general. To assist in applying the techniques, computer programs for diagnostic evaluation were developed. The program uses Fast Fourier Transform (FFT) a mathematical tool for analyzing a periodic function—to reduce the analog data to digital form. The raw data are also categorized in power spectral-density bands. A program for likelihood analysis computes the statistical means and variances for reference data signatures and for test data signatures; it then computes probabilities that the signature populations in various frequency bands are identical within a prescribed number of standard deviations. By this procedure the mechanical replaceable unit is classified as “satisfactory operation” or “impending failure”. Signatures for the impending failure classes for specific components are developed by sensing and processing specific failure-related data. Fig. 7-4 illustrates the diagnostic logic used for the analysis of vibration signatures of rotating components.

### 7-6.2 ADVANCED ATTACK HELICOPTERS

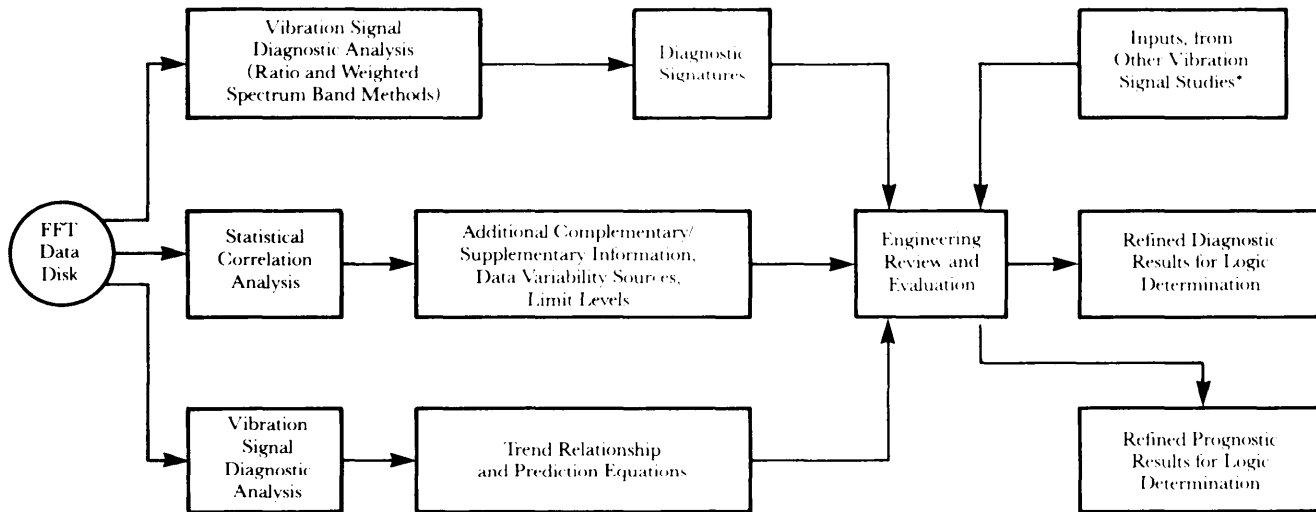
The Advanced Attack Helicopter (A AH) was designed to surpass any existing Army aircraft in weaponry sophistication (Ref. 21). This aircraft provides an excellent example of how BITE was applied to solve critical diagnostic problems.

The Fault Detection Location Subsystem (FD/LS) for the AAH employs a combination of BITE ATE, ground test equipment, technical manuals, and manual diagnostic procedures to accomplish its function. Table 7-3 provides a list of the systems that can be tested on the A AH by BITE. This list is part of the operator's checklist.

The on-aircraft fault isolation is provided for replaceable units in the following subsystems:

1. FD/LS itself
2. Armament
3. Flight control
4. Auxiliary power
5. Pilot's night vision
6. Integrated helmet sight and display
7. Fuel
8. Environmental control
9. Antiice and deice
10. Fire control
11. Instruments
12. Navigation
13. Avionics
14. Multiplex
15. Electric power
16. Fire detection and extinguishing
17. Intermediate gearbox
18. Tail rotor gearbox.

In the area of electronics, the FD/LS detects and isolates faults to the repairable module level. The replaceable units have sufficient test provisions to detect and isolate 98% or more of all failures to the repairable module. Fig. 7-5 shows the data entry keyboard used by the crew to



\*e.g., Vibration Signal Analysis Techniques

Figure 7-4. Data Analysis Methodology for Vibration signals (Ref. 20)

TABLE 7-3. DIAGNOSTIC PORTION OF OPERATOR'S CHECKLIST

SYSTEM TEST AND FD/LS SUBSYSTEM CODES

System Test	Keyboard* Entry Code
End-to-End Test	G/M ETE
Multiplex System	G/M MUX
Fire Control Computer	G/M FCC
Symbol Generator	G/M SYGN
Target Acquisition and Designation System	G/M TADS
Electrical Generation	G/M EGN
Main Transmission/Nose Gearbox	G/M TRAN
Air Data Subsystem	G/M ADS
Ice Detector	G/M ICED
Rotor Blade Deice	G/M RBD
Canopy Temperature Controller	G/M CTC
External Stores	G/M EXST
Heading Attitude Reference System	G/M HARS
Electronic Attitude Display Indicator	G/M EADI
Integration Helmet and Display Indicator	G/M IHDS
Automatic Stabilization Equipment	G/M ASE

SYSTEM TEST AND FD/LS SUBSYSTEM CODES  
(cont'd)

System Test	Keyboard* Entry Code
Hellfire Missile	G/M MSI
Area Weapon	G/M GUN
Aerial Rocket	G/M RKT
Pilot Night Vision System	G/M PNVS
Auxiliary Power Unit	G/M APU

\*Notes:

1. Any keyboard entry preceded by a "G" indicates that the copilot/gunner is conducting the test.
2. Any keyboard entry preceded by an "M" indicates that maintenance personnel are conducting the test.

Excerpted from 77-TM-8002-2.

Copilot/Gunner's Panel

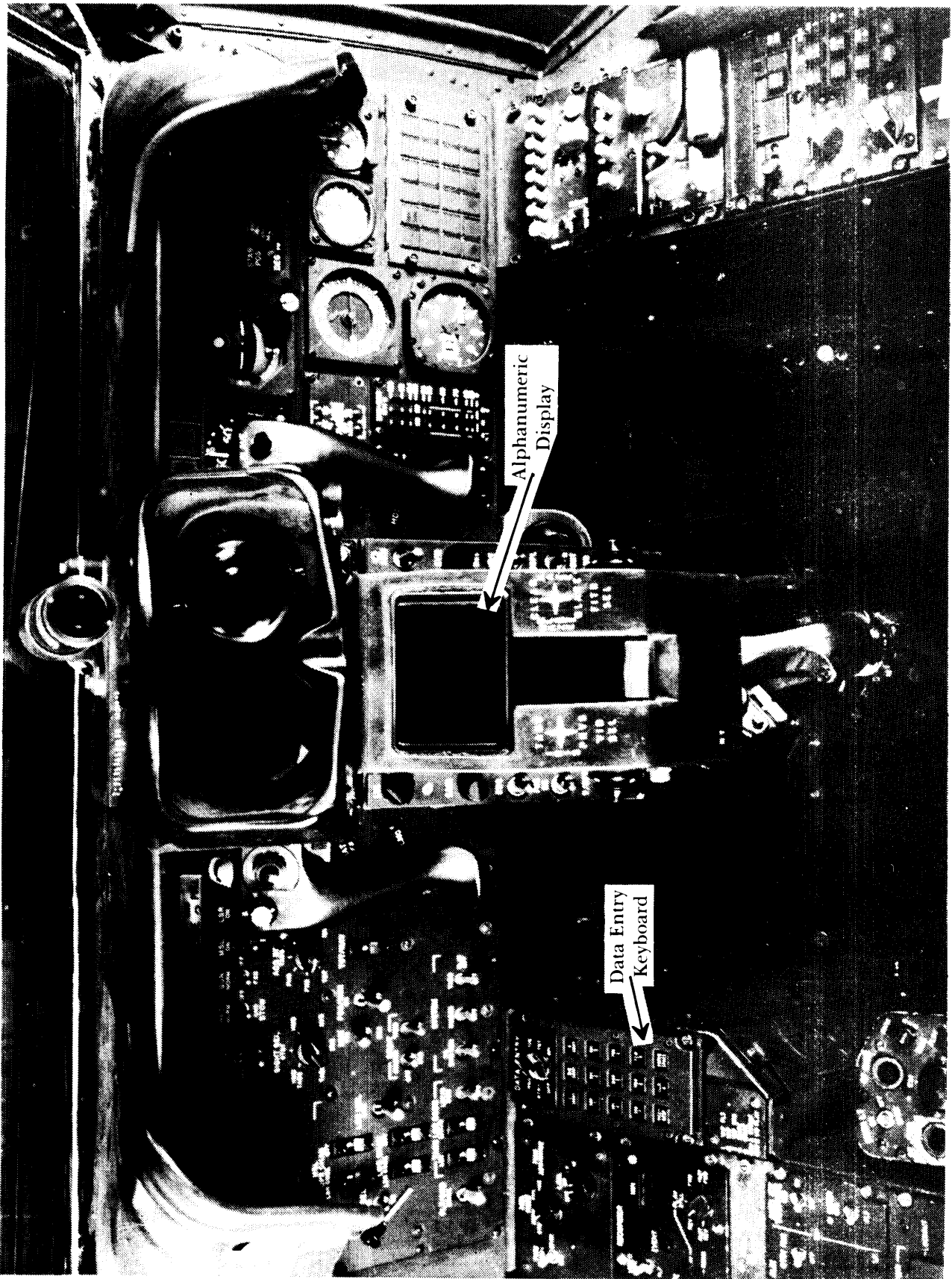


Figure 7-5. Design Approach Fault Detection and Location Subsystem (Ref. 21)

locate faults during preflight checkout and by the maintenance personnel to locate and diagnose faults during postflight operations. The diagnostic data supplied by the BITE are presented on the alphanumeric display on the copilot, gunner's panel.

A critical diagnostic problem on the AAH relates to the automatic control of the stabilator, i.e., a movable, horizontal stabilizer located near the tail of the helicopter. The leading edge of the stabilator moves up or down to maintain an even pitch as the helicopter makes transitions in speed. A predecessor to the AAH crashed because its airspeed indicators were not connected to the position sensors, which caused the helicopter to pitch over when making the transition from hover to forward flight. Accordingly, specifications for stabilator control were written to guard against instability hazards. Fig. 7-6 illustrates the redundant control system and diagnostics employed to insure a positive connection between the airspeed indicator and the position sensor. The BIT equipment circuitry simulated failure signals for every critical fault mode so that the monitor could be automatically checked out in preflight simulation.

### 7-6.3 T700 GAS TURBINE

The diagnostic analysis of the T700 gas turbine is typical of analysis results for gas turbine engines used in Army trucks and aircraft; the data are excerpted from Ref. 23. Table 7-4 summarizes the results of diagnostic effective-

ness analysis, i.e., ratio of the failures not detected by the diagnostic equipment and procedures to the total failures, for engine modules. Table 7-5 is a typical page from the Failure Mode and Effect Analysis backup for Table 7-4 for the Cold Section Module (CSM) of the T700 engine. The numerically coded fault isolation elements of Table 7-5 are identified in Table 7-6. The failure rates in Table 7-5 Categories II and IV—for the various engine components, Column 1, that can be isolated within the CSM are shown in Columns 4 and 5, respectively; the fault isolation elements are shown in Column 6. These failure rates for Categories II and IV—Columns 4, 5, 7, and 8—are summed for insertion into the summary of diagnostic effectiveness data in Table 7-4. These analysis samplings are typical of those performed to validate the design effectiveness of the diagnostic equipment and the testability features built into a gas turbine engine.

### 7-7 CHECKLISTS

Table 7-7 provides a checklist to aid in the design of diagnostic networks and function grouping in the prime end-item for optimal testing. Table 7-8 lists questions to be answered by the designer to assist in the determination of the required diagnostic and preferred test equipment. If the answer is "no" for any answer on the checklists, the design should be restudied to determine whether correction is required.

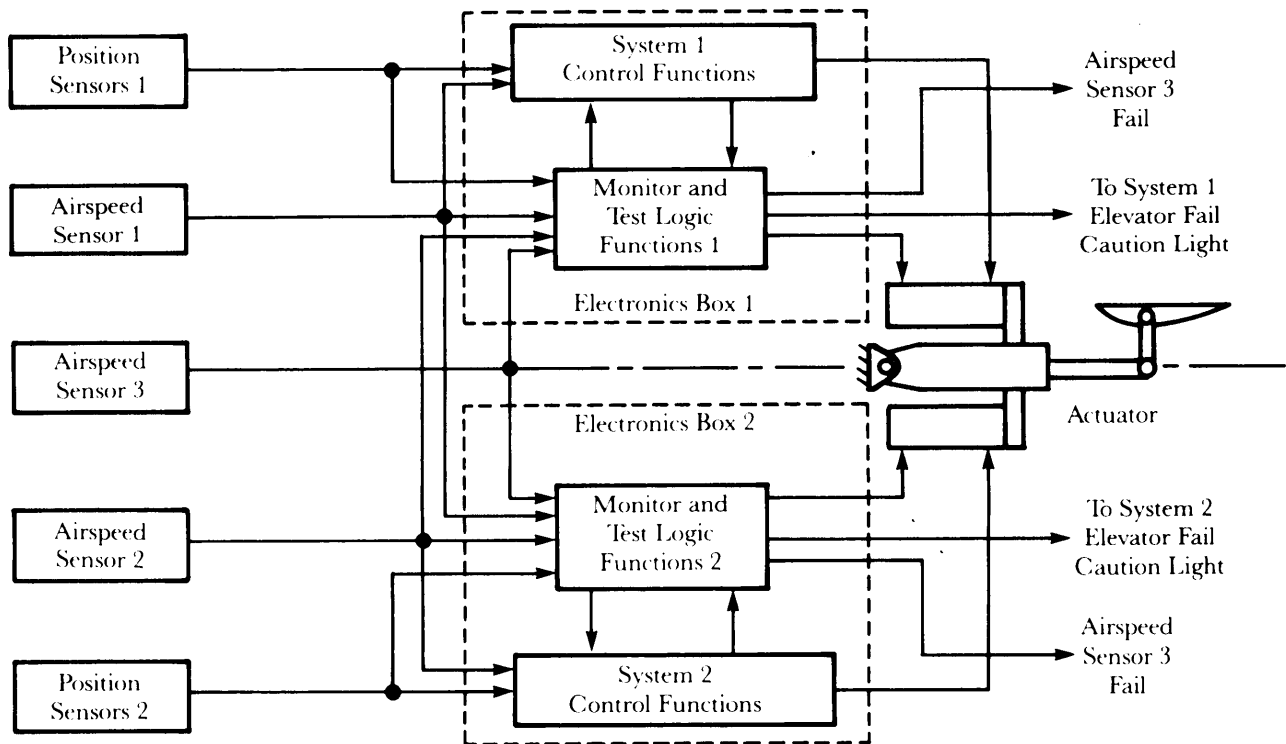


Figure 7-6. Redundant FBW Stabilator

**TABLE 7-4. SUMMARY OF DIAGNOSTIC EFFECTIVENESS  
FOR GAS TURBINE ENGINE (Ref. 23)**

	Total Events (per 10 <sup>6</sup> EFH)		Nonisolated Events (per 10 <sup>6</sup> EFH)		Percent of Nonisolated to Total Events		
	Class II	Class IV	Class II	Class IV	Class II	Class IV	Total
LRUs	0.0924	44.686	0.0009	2.1948	0.97	4.91	4.90
CSM	4.892	27.977	0.6612	5.7692	13.52	20.62	19.56
HSM	0.228	8.958	0.0023	1.7916	1.01	20.0	19.53
PTM	0.298	12.1	0.0090	0.802	3.02	6.63	6.54
ACC	0.0	3.698	0.0	0.0739	0.0	2.0	2.0
ENG	12.88	0.0	0.188	0.0	10.0	0.0	10.0
Totals	7.390	97.419	0.8614	10.6315	11.66	10.91	
Combined Totals	104.809		11.4929		10.97		

EFH—Engine Flight Hours

LRU—Line-Replaceable Unit

CSM—Cold Section Module

HSM—Hot Section Module

PTM—Power Turbine Module

ACC—Accessory Module

ENG—Engine, Assembly

Class II—Failures that result in in-flight shutdowns, i.e., unrecoverable power loss.

Class IV—Failures that result in power loss or no start.

TABLE 7-5. TYPICAL FMEA BACKUP (Ref. 23)

① Item	② Failure Mode	③ Engine Effect	④ Failure Rate		⑤ Fault Isolation Elements	⑦ Nonisolated Events		⑧ Prob.
			II	IV		II	IV	
Cold Section Module (cont'd) State 1 Blade/Disk (cont'd)	Rub.	Reduced performance	—	0.45	Gas Generator Bearing Accelerometer, Health Monitor, Bearing Monitor, Borescope Set, Pilot/ Flight Crew, Preventive Maintenance Crew, Corrective Maintenance Crew	—	50	0.225
	Loss of abrasible coating	Reduced performance	—	0.338	Gas Generator Bearing Accelerometer, Health Monitor, Bearing Monitor, Borescope Set, Pilot/ Flight Crew, Preventive Maintenance Crew, Corrective Maintenance Crew	—	50	0.169
	Corrosion	Performance loss	—	0.15	*26, 29, 30, 31	—	1	0.0015
Stage 2-5 Blade 1 Disks	Erosion	Reduced performance	—	0.60	5, 26, 29, 30, 31	—	5	0.03
	Rub	Reduced performance	—	1.2	3, 26, 28, 29, 30, 31, 32	—	50	0.6
	Loss of abrasible coating	Reduced performance	—	0.9	3, 26, 28, 29, 30, 31, 32	—	50	0.45
	Corrosion	Performance loss	—	0.3	26, 29, 30, 31	—	1	0.003
Inlet Guide Vane	Seizure	Possible shutdown	0.1	—	30, 31	0.05	50	0.05
	Rubs	Power loss	—	0.2	26, 29, 31	—	80	0.16
Stage 1 and 2 Vanes	Seizure	Possible shutdown	0.186	—	30, 31	0.093	50	0.186
	Rubs	Power loss	—	0.371	3, 26, 28, 29, 30, 31, 32	—	50	0.186
Stage 3-5 Vanes	Rubs	Power loss	—	0.695	3, 26, 28, 29, 30, 31, 32	—	50	0.348
Deswirl Casting	Crack	Slight performance loss	—	0.4	25, 30, 31	—	30	0.12
	Creep	Slight performance loss	—	0.08	25, 30	—	100	0.08
	Plugged drain holes	Possible overtemperature	—	0.16	22, 30, 31	—	10	0.016
Centrifugal Compressor Diffuser	Impeller rub	Loss of performance	0.16	—	25, 30	0.16	100	0.16
Compressor Impeller	Erosion	Loss of performance	—	0.563	5, 26, 29, 30, 31	—	5	0.0281

(cont'd on next page)

**TABLE 7-5 (cont'd)**

① Item	② Failure Mode	③ Engine Effect	④ Failure Rate		⑤ IV	⑥ Fault Isolation Elements	⑦ Nonisolated Events Prob.		⑧ IV
			II	IV			II	IV	
Impeller Shroud	Rub	Loss of performance	—	0.563		3, 26, 28, 29, 30, 31, 32	—	—	0.282
	Rub	Reduced performance	—	0.64		3, 26, 28, 29, 30, 31, 32	—	—	0.32
	Loss of abrasible coating	Performance loss	—	0.32		3, 26, 28, 29, 30, 31, 32	—	—	0.16
Axial Compressor Spacer	Loss of abrasible coating	Possible power loss	—	0.073		3, 26, 28, 29, 30, 31, 32	—	—	0.036
Front Frame	Cracking	Possible compressor rubs	—	0.54		3, 28, 29, 30, 31, 32	—	—	0.36
	Cracking	Possible loss of oil supply	0.027	—		6, 8, 29, 31, 32	20	0.005	—
Oil leakage	Plugged	Bearing failure	0.027	—		2, 3, 9, 10, 11, 12, 23, 27, 28, 32	1	0.0003	—
	Oil leakage	Minor oil loss	—	0.162		6, 29, 31, 32	1	—	0.0016

\*See Table 7-6 for codes.

**TABLE 7-6. ELEMENTS FOR  
FAULT ISOLATION (Ref. 23)**

**QUALIFICATION ITEMS**

1. History Recorder
2. Master Chip Detector
3. Gas Generator Bearing Accelerometer
4. Power Turbine Bearing Accelerometer
5. Erosion Indicator
6. Oil Level Sight Glass
7. Oil Temperature Sensor
8. Oil Pressure Sensor
9. Oil Filter Actual Bypass Sensor
10. Oil Filter Impending Bypass Sensor
11. Oil Screen—A Sump Aft
12. Oil Screen—A Sump Forward
13. Oil Screen—B Sump
14. Oil Screen—C Sump Aft
15. Oil Screen—C Sump Forward
16. Oil Screen—Accessory Gearbox
17. Gas Generator Speed Sensor
18. Power Turbine Speed Sensor
19. Torque Sensor
20. Fuel Filter Actual Bypass Sensor
21. Fuel Filter Impending Bypass Sensor
22. Gas Temperature Indicator
23. SOAP Sample Accessibility (Spectrographic Oil Analysis Procedure)
24. FOD Signal (Foreign Object Damage)
25. Airframe Fire Warning System

**SUPPORT ITEMS**

26. Health Monitor
27. Oil Quality Analyzer
28. Bearing Monitor
29. Borescope Set
30. Pilot/Flight Crew
31. Preventive Maintenance Crew
32. Corrective Maintenance Crew

**TABLE 7-7. TESTABILITY CHECKLIST**

1. Was the testability design concurrent with prime equipment design?
2. Did test point selection, and design and testing partitioning play a major role in the layout and packaging of the system?
3. Was a failure modes and effects analysis available and used as a part of the testability analysis?
4. Were BIT/BITE and ATE analyses and fault simulation used to evaluate the coverage and effectiveness of the test equipment design?
5. Did the testability design approach evolve as information was obtained from analyses and test experience?
6. Was a level of repair analysis used as part of the testability analysis?
7. Are test points located on the front panel wherever possible?
8. Are system test points accessible without removing modules and/or components?
9. Is accessibility of external test points assured?
10. Are test points conveniently grouped for accessibility and sequential arrangement of testing?
11. Is each test point labeled with a name or symbol appropriate to that point?
12. Is each test point labeled with the in-tolerance signal or limits that should be measured?
13. Are test points labeled with the designation of what output is available?
14. Are all test points color coded with distinctive colors?
15. Are test points provided in accordance with the system test plan?
16. Are test lead connectors used that require no more than a fraction of a turn to connect?
17. Are test points located close to the controls and displays with which they are associated?
18. Is the test point used in an adjustment control?
19. Are means provided for an unambiguous signal indication at the test point when the associated control has been moved?
20. Are test points located so the technician operating the associated control can read the signal on display?
21. Are test points provided to isolate a failure to replaceable units or modules?
22. Are fan-out cables in junction boxes used for testing if isolated test points are not conveniently provided?
23. Are test points planned for compatibility with the maintenance skill levels involved?
24. Are test points coded or cross-referenced with the associated units to indicate the location of faulty circuits?
25. Are test points provided to reduce the number of steps required—i.e., split-half isolation of trouble, automatic self-check sequencing, minimizing of step retracing or multiple concurrent tests?
26. Are test points located to reduce search time—i.e., near main access openings, in groups, properly labeled, near primary display to be observed from working position?
27. Are test points that require test probe retention provided with fixtures so that the technician will not have to hold the probe?
28. Are built-in test features provided wherever standard portable test equipment cannot be used?
29. Are test points adequately protected and illuminated?
30. Are routine test points provided that are available to the technician without removal of the chassis from the cabinet?

TABLE 7-8. DIAGNOSTIC CHECKLIST

1. Since BITE manual or automatic—usually will increase the complexity and cost of a system, is this requirement the result of careful study?
2. Was the progress of the BITE and ATE design monitored and evaluated? Were adequate time and funds allocated in the development plan to prove the effectiveness of test equipment? Was the test equipment used to verify items in production?
3. Were adequate demonstrations, as required contractually, performed to determine BITE or ATE performance? Was the laboratory performance—achieved by inserting faults or malfunctions—consistent with that observed in a real environment?
4. Were the number of false alarms, could not duplicates, and retests satisfactory consistent with the contractual limitations specified?
5. Are the instructions for using test equipment in a step-by-step format?
6. Is a signal provided that shows when the test equipment is warmed up? If it is not feasible to present such a signal, is the warm-up time required clearly indicated near the warm-up switch or is a lockout provided until equipment has warmed up?
7. Is a simple check provided to indicate when the test equipment is out of calibration or is otherwise not functioning?
8. Do test equipment displays that require conversion of observed values have conversion tables attached to the equipment with the scale factor by each individual switch position or display scale?
9. Is adequate support provided for UUT test equipment that must be taken into the work area so the technician does not have to support the test equipment or to take separate support devices to the work area for this purpose?
10. Does portable test equipment have a mass of under 23 kg (50 lb) if it is to be carried by one person? If not, can it be separated into two or more assemblies?
11. Are display lights, automatic power switches, or printed warnings provided to insure that test equipment is turned off when testing is completed?
12. Is the purpose of test equipment and special precautions displayed in a conspicuous place on the outer surface of the test equipment?
13. Are units that are not self-checking designed to be checked in the operating condition without the aid of special rigs and harnesses wherever possible?
14. Are selector switches provided in lieu of a number of plug-in connectors?
15. Is test equipment designed to be capable of connection to prime equipment within 2 min or less?
16. Does continuing analysis of automatic test hardware design provide assurance of greater maintainability improvement potential than is possible by system design changes?
17. Does error analysis of the checkout capability of the test system verify conformance to specified detectability requirements?
18. Does the test system provide fault isolation to the desired replacement level?
19. Is test hardware design compatible with system environmental requirements?
20. Has the use of commercial test equipment or Government-furnished test equipment been considered?
21. Was the design of test equipment based on an adequate failure prediction baseline?
22. Are self-test features and procedures adequate to insure proper automatic test operation over sustained periods of system test?
23. Has test equipment been built with sufficient ruggedness to reduce the need for frequent calibration?
24. Are all parameter and measurement limits established?
25. Is the output format satisfactory to the user; can the output as formatted be used for data collection or interpretation?
26. Is the automatic test function operable without difficulty by all levels of maintenance personnel?
27. Do the sensors operate without disturbing or loading the system under test?
28. Is the automatic test hardware failsafe, i.e., will its failure not result in system failure?
29. Has the availability of necessary inputs to and the conditioning of ATE in the installed position been verified—e.g., power, cooling, external references?
30. Are untestable parameters or units identified; can the system design be changed to eliminate them?
31. Has a closed cycle heating or cooling system, if necessary, been considered to maintain the proper test set environment, and if used, has the source of coolant or the source of heat been ascertained and coordinated with system design?

(cont'd on next page)

TABLE 7-8 (cont'd)

32. Have transducers been selected that give quick, consistent, and repeatable responses?
33. Are test stimuli—introduced into a system or component to determine its status safe. i.e.. will not damage the system or component or cause inadvertent functioning?
34. Has a sneak circuit analysis been performed on critical mission components that interface with test equipment, particularly where circuit changes have been introduced?
35. Are the selection and acquisition of test equipment in accordance with AR 750-43—e.g., is DA PAM 700-21-1, preferred items list (PIL), used for priority selection of Army standard test equipment?
36. Is the test equipment hardware and/or software designed for logistic supportability?
37. Do the ATE and/or test program sets use a DOD-approved automated test language, e.g., C/ATLAS or IEEE-7 16?
38. Is the ATE/test equipment selected compatible with the UUT design?
39. Was the ATE/test equipment selected for commonality and/or compatibility with ATE, test equipment at other maintenance levels?

## REFERENCES

1. IDA/OSD Reliability and Maintainability Study, Vol. II: Core Group Report, IDA Report R-272, November 1983.
2. IDA/OSD Reliability and Maintainability Study, F-16, APG-66 Fire Control Radar Case Study Report, IDA Record Document D-21, August 1983.
3. Jane's Defence Weekly, 5, No. 8, 352 (1 March 1986), London, England.
4. MIL-STD-2165, Testability Program for Electronic Systems and Equipments, 26 January 1985.
5. IDA/OSD Reliability and Maintainability Study, R&M Program Review Elements Document, IDA Record Document D-26, August 1983.
6. AMC Pamphlet 70-2, AMC-TRADOC Materiel Acquisition Handbook, 26 March 1987.
7. V. Tasar and Henry L. Ohlef, "A Method for Determining the Statistically Weighted Percent Fault Detection Coverage of a Self-Test System", Proceedings of the 1979 Annual Reliability and Maintainability Symposium, p. 39.
8. DOD 3235.1-H, Test and Evaluation of System Reliability, Availability, and Maintainability: A Primer, p. 3-8, March 1982.
9. IDA/OSD Reliability and Maintainability Study, Vol. II: Core Group Report, IDA Report R-272, pp. IV-15 to IV-21, November 1983.
10. IDA/OSD Reliability and Maintainability Study, Vol. II: Core Group Report, IDA Report R-272, p. 11-12, November 1983.
11. IDA/OSD Reliability and Maintainability Study, Vol. IV: Technology Steering Group Report, IDA Report R-272, p. IV-34, November 1983.
12. IDA/OSD Reliability and Maintainability Study, 7700 Engine Case Study, IDA Record Document D-22, p. IIC-95, August 1983.
13. Calvin Holbert and Gary Newport, Helicopter Maintenance Effectiveness Analysis, USAAMRDL-TR-75-14, Eustis Directorate, US Army Air Mobility Research and Development Laboratory, Fort Eustis, VA, May 1975.
14. MIL-STD-1309, Definitions of Terms for Test, Measurement, and Diagnostic Equipment, 18 November 1983.
15. Paul Harmon and David King, Expert Systems, John Wiley and Sons, Inc., New York, NY, 1985.
16. The General Dynamics System for Sneak Circuit Analysis, General Dynamics Convair Division, San Diego, CA, June 1983.
17. MIL-STD-785, Reliability Program for Systems and Equipment Development and Production, 15 September 1980.
18. AIDAPS Program, First Interim Technology Report, Report 74010011, Garrett Air Research Manufacturing Company, Los Angeles, CA. 30 December 1973.
19. NAVORD OD 39223, Maintainability Engineering Handbook, 1 February 1970.
20. D. B. Board, "Incipient Failure Detection in High-Speed Rotating Machinery", Boeing Vertol Co., Philadelphia, PA, 10th Symposium on Nondestructive Evaluation held 23-25 April 1975.
21. A MC-SS-AA H-H 10000A, System Specification for YAH-64 Advanced Attack Helicopter, 30 July 1976.
22. S. W. Ferguson and K. E. Builta, "Development of a Fly-by-Wire Elevator for the Bell Helicopter Textron 214ST", 35th Annual National Forum of the American Helicopter Society, Washington, DC, May 1979.
23. Diagnostic System Effectiveness Report for General Electric T700-GE-700 Engines, 18 December 1972.

**This page intentionally left blank.**

## CHAPTER 8

### PREVENTIVE MAINTENANCE

*This chapter describes the types of maintenance that are classified as “preventive”; the means for determining the cost-effectiveness of preventive maintenance, and the trade-of between the inherent downtime for preventive maintenance and the desired level of equipment performance and reliability. Reliability Centered Maintenance (R CM) is discussed, and an example of its application is given. The Army Oil Analysis Program (AOAP) is presented as a major contributor to more efficient maintenance. Design considerations for ease of lubrication, servicing, and cleaning and preservation of equipment for use and for longtime storage are outlined. A servicing checklist is provided.*

#### 8-0 LIST OF SYMBOLS

<p><math>A_{a_1}, A_{a_2}</math> = achieved availability, dimensionless</p> <p><math>C_c</math> = projected cost of returning item to service if failure occurs at a random time, dollars (This cost item includes such entities as towing, transport of crews and equipment, and out-of-service (loss of use) costs.)</p> <p><math>C_{cm}</math> = cost of corrective maintenance with no preventive maintenance program, dollars</p> <p><math>C_{mat}</math> = cost of materials for each preventive maintenance action, dollars</p> <p><math>C_{mh}</math> = cost per man-hour to perform preventive maintenance, dollars/man-hour</p> <p><math>C_p</math> = cost of replacement parts to correct failure, dollars</p> <p><math>C_{pm}</math> = cost of maintenance for time <math>T</math> with a preventive maintenance program, dollars</p> <p><math>M</math> = number of persons required to repair item of equipment, men</p> <p><math>MMH</math> = maintenance man-hours required to perform required preventive maintenance task (each time), man-hours</p> <p><math>MTBDE</math> = mean time between downtime events,</p> <p><math>(MTBF)_c</math> = mean time between failures for item without preventive maintenance, h</p> <p><math>(MTBF)_p</math> = mean time between failures for item with preventive maintenance, h</p> <p><math>(MTBMA)_p</math> = mean time between preventive maintenance actions, h</p> <p><math>MTTR</math> = mean time to repair item to correct failure under evaluation, h</p> <p><math>MTTRS</math> = mean time to restore system, h</p> <p><math>OT</math> = operating time during a given calendar period, h</p>	<p><math>T</math> = calendar time over which evaluation is to be determined, h (This could be the expected life of the equipment.)</p> <p><math>TCM</math> = total corrective (unscheduled) maintenance downtime during same calendar period, h</p> <p><math>TPM</math> = total preventive (scheduled) maintenance downtime during same calendar period, h</p> <p><math>V_{pm}</math> = value of alternate maintenance concepts, dollars</p>
---	--

#### 8-1 INTRODUCTION

Maintenance—actions necessary for retaining materiel in, or restoring it to, a serviceable condition is precipitated by various causes and can occur in different locations. Maintenance actions can be categorized as falling into three types—preventive, corrective, and servicing—defined as follows:

1. *Preventive Maintenance.* Performed to retain an item in satisfactory operational condition by providing systematic inspection, detection, and prevention of incipient failures. Detection and prevention may take place either before failures occur or before they develop into major defects.

2. *Corrective Maintenance.* Performed to restore an item to a satisfactory condition by correcting a malfunction that has caused degradation of the item below the specified performance level.

3. *Servicing Maintenance.* Performance of any act—other than prevention or correction—required to retain an item of equipment in operating condition. Such actions include lubricating, fueling, oiling, cleaning, etc. Servicing does not include periodic part replacements or any corrective maintenance tasks.

The basic maintenance actions—preventive and corrective—can occur while the equipment is in or out of service. Thus in maintenance planning evaluations it is necessary to recognize not only the type and criticality of action required but also the operational status and role of the equipment. This relationship is illustrated by Fig. 8-1, which shows that noncritical repairs, even though neces-

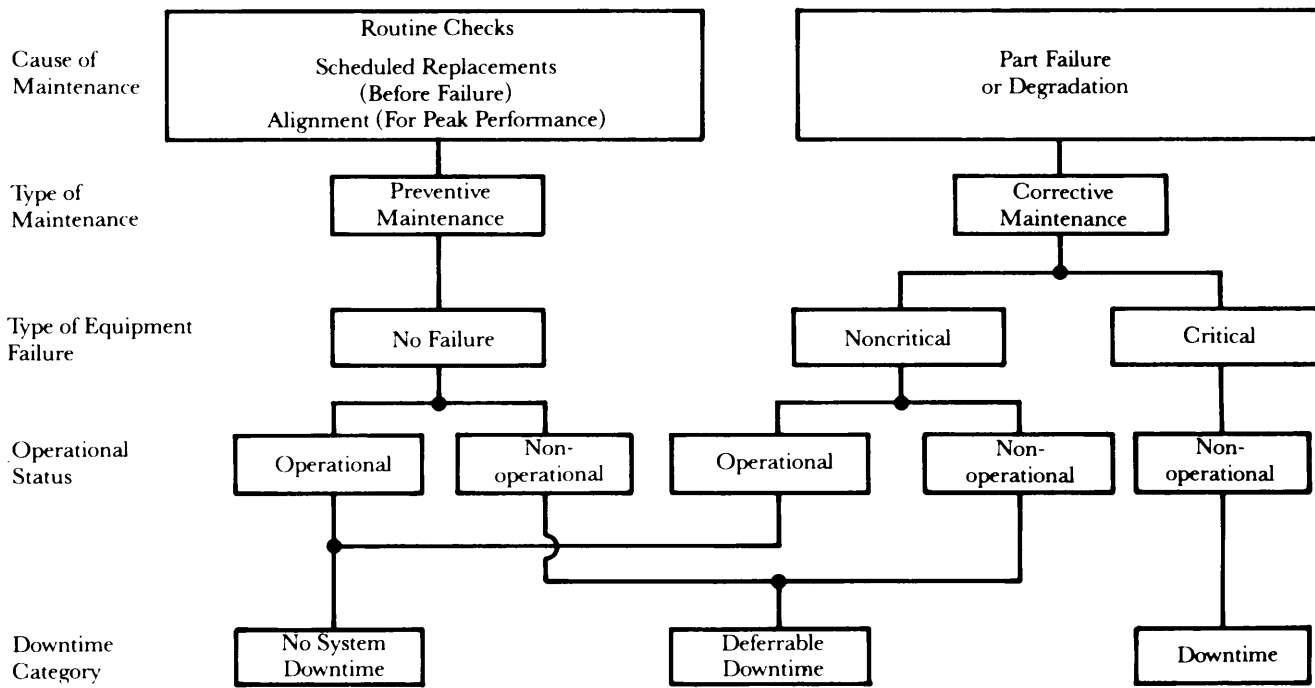


Figure 8-1. Relation of Equipment Status on Availability

sary, can be deferred until the equipment is idle (between missions) or until scheduled maintenance; this results in increased equipment availability.

Preventive maintenance and servicing are more applicable to mechanical systems and basic structural elements than to electronic or electrical equipment. The routine checkout of electronic or electrical equipment indicates that the equipment is performing satisfactorily or unsatisfactorily. Physical inspection remains the primary means for detecting degradation of structures and of many mechanical and electromechanical devices.

## 8-2 RELIABILITY CENTERED MAINTENANCE

### 8-2.1 GENERAL

The Reliability and Maintainability Subcommittee of the Air Transport Association published a Maintenance Steering Group document, *Airline Manufacturer's Maintenance Program and Planning Document (MSG-2)*(Ref. 1), which described the reliability centered maintenance (RCM) concept for new aircraft. This concept was so successful in its initial application that the airlines applied it to revise maintenance programs for older aircraft. The US Navy tailored the concept and applied it to the P-3 aircraft. Through the issuance of Program Objective Memorandum (POM) 78-82 (Ref. 2), the Army established the requirement that the MSG-2 concept, under the title "Reliability Centered Maintenance (RCM)", be incorporated on all Army weapon systems and equipment by the end of fiscal year 1979. DA Pam 750-40 (Ref. 3) implements Ref. 2. The US Army Materiel Command

(AMC) integrated the provisions of Ref. 3 into AMC-P 750-2, *Guide to Reliability Centered Maintenance* (Ref. 4). AMC-P 750-2 provides assistance in the preparation and implementation of the RCM program as directed in the policies of DOD Directive 4151.16 (Ref. 5). AR 750-1 (Ref. 6), AR 700-127 (Ref. 7), and MIL-STDS-1388 (Refs. 8 and 9). Through the proper use of RCM procedures, a viable, realistic scheduled maintenance program can be developed. Ref. 4 describes in detail how to use the RCM logic and the failure mode, effects, and criticality analysis (FMECA) to develop a scheduled maintenance plan that includes the maintenance task and the maintenance interval for preventive maintenance checks and services (PMCS) and provides information for overhaul, age exploration, economic analysis, and redesign.

### 8-2.2 OBJECTIVE

Maintenance planning one of nine principal elements of integrated logistics support (ILS)—includes development of the maintenance concept, reliability and maintainability parameters, repair level determinations, maintenance requirements, and supply support essential to adequate and economical support of the system or equipment (Ref. 4). As such, maintenance planning is normally integrated into equipment design during the concept exploration phase of the acquisition process as part of the logistical support analyses. RCM is an essential input to this planning.

RCM is based on the premise that maintenance cannot improve upon reliability inherent in the design of hardware; good maintenance can only preserve this character-

istic. The object of RCM is to preserve the inherent design levels of reliability and accomplish it at minimum cost. The RCM concept uses decision logic to evaluate and construct maintenance tasks which are based on the equipment functions and failure modes. Evaluation of equipment designs in accordance with RCM techniques will also determine when it is cost-effective to employ preventive maintenance and when it is not cost-effective. It is essential that the RCM analysis be integrated with the maintainability concepts for testability and diagnostic techniques.

### 8-2.3 RELIABILITY CENTERED MAINTENANCE LOGIC

RCM logic is intended for application when the failure mode, effect, and criticality of component failure has been identified. Fig. 8-2 (Ref. 4) illustrates the RCM analysis process—a process that is applied to each repairable item in the equipment or system. The logic is designed to accomplish the following (Ref. 4):

1. By using data from the system safety and reliability programs, identify components in the system or equipment that are critical in terms of mission or operating safety.
2. Provide a logical analysis process to determine the feasibility and desirability of scheduled maintenance task alternatives.
3. Highlight maintenance problem areas for design review consideration.
4. Provide the supporting justification for scheduled maintenance task requirements.

Par. 4-9, Ref. 4, presents a detailed discussion on the application of the logic steps identified in Fig. 8-2.

The functional failure identified by the application of RCM logic can be assessed for consequence of failure and is processed according to its severity category—i.e., catastrophic, critical, marginal, or minor. The logic process is based on the following (Ref. 4):

1. *Minor or Marginal Severity Categories.* Scheduled maintenance tasks should be performed only when performance of the scheduled task will reduce the life cycle cost of the equipment or system.
2. *Critical and Catastrophic Severity Categories.* Scheduled maintenance tasks should be performed when such tasks will prevent a decrease in reliability or deterioration of safety to unacceptable levels or when the task will reduce the life cycle cost of ownership of the equipment or system.

### 8-2.4 DISPOSITION OF RELIABILITY CENTERED MAINTENANCE ANALYSIS

Each failure analyzed by the application of the RCM logic leads the analysts to make a decision on the disposition of each failure mode. The Data Record B: Item

Reliability (R) and Maintainability (M) Characteristics form, Fig. 8-3, is used to record the disposition. Instructions for locating the data on the form are contained in par. 4-8 (Ref. 4).

## 8-3 PREVENTIVE MAINTENANCE EVALUATION PARAMETERS AND TRADE-OFFS

The relative values of preventive maintenance actions may be determined as a function of several performance and cost parameters. The value should be quantified whenever possible to remove the decision from subjective judgment. However, performance and cost must never be traded off with safety.

Preventive maintenance actions incur cost in terms of materials, man-hours, and equipment downtime; hence the detailed analysis discussed in par. 8-2. The cost of man-hours and repair parts and materials can be determined rather easily. The cost of equipment downtime, however, is a function of the operational value of the particular equipment in the situation that exists when it is down. Accordingly, maintenance is scheduled into the operations when there is the minimum risk that the equipment will be required for an operational assignment. The two chief parameters—availability and cost of ownership—relative to an optimum preventive maintenance program are discussed in the paragraphs that follow.

### 8-3.1 AVAILABILITY

Achieved availability is the probability that a system or equipment, when used under stated conditions in an ideal support environment—i.e., available tools, parts, manpower, manuals, etc.—shall operate satisfactorily at a given time. Note that supply downtime and waiting or administrative downtime are excluded. Two equations for achieved availability are given

$$A_{a1} = \frac{OT}{OT + TCM + TPM}, \text{ dimensionless} \quad (8-1)$$

where

- $A_{a1}$  = achieved availability, dimensionless
- $OT$  = operating time during a given calendar period, h
- $TCM$  = total corrective (unscheduled) maintenance downtime during same calendar period, h
- $TPM$  = total preventive (scheduled) maintenance downtime during same calendar period, h

and, in terms of DOD Directive 5000.40 (Ref. 10),

$$A_{a2} = \frac{MTBDE}{MTBDE + MTTRS}, \text{ dimensionless} \quad (8-2)$$

where

- $A_{a2}$  = achieved availability, dimensionless

\*Every decision made by using this logic diagram will result in an entry on the B sheet ISAF data record on the BII card in Subcolumn 5A. Blocks 1-18 (19-20 are spares). Additional entries may be required. See par. 4-9, AMC-P 750-2, Ref. 4, for detailed instructions.

NOTE: After entering Blocks 11-15, all remaining blocks of that sequence must be considered regardless of what the decision is in any preceding block. This may take us to Block 17, "Is Redesign Applicable?"

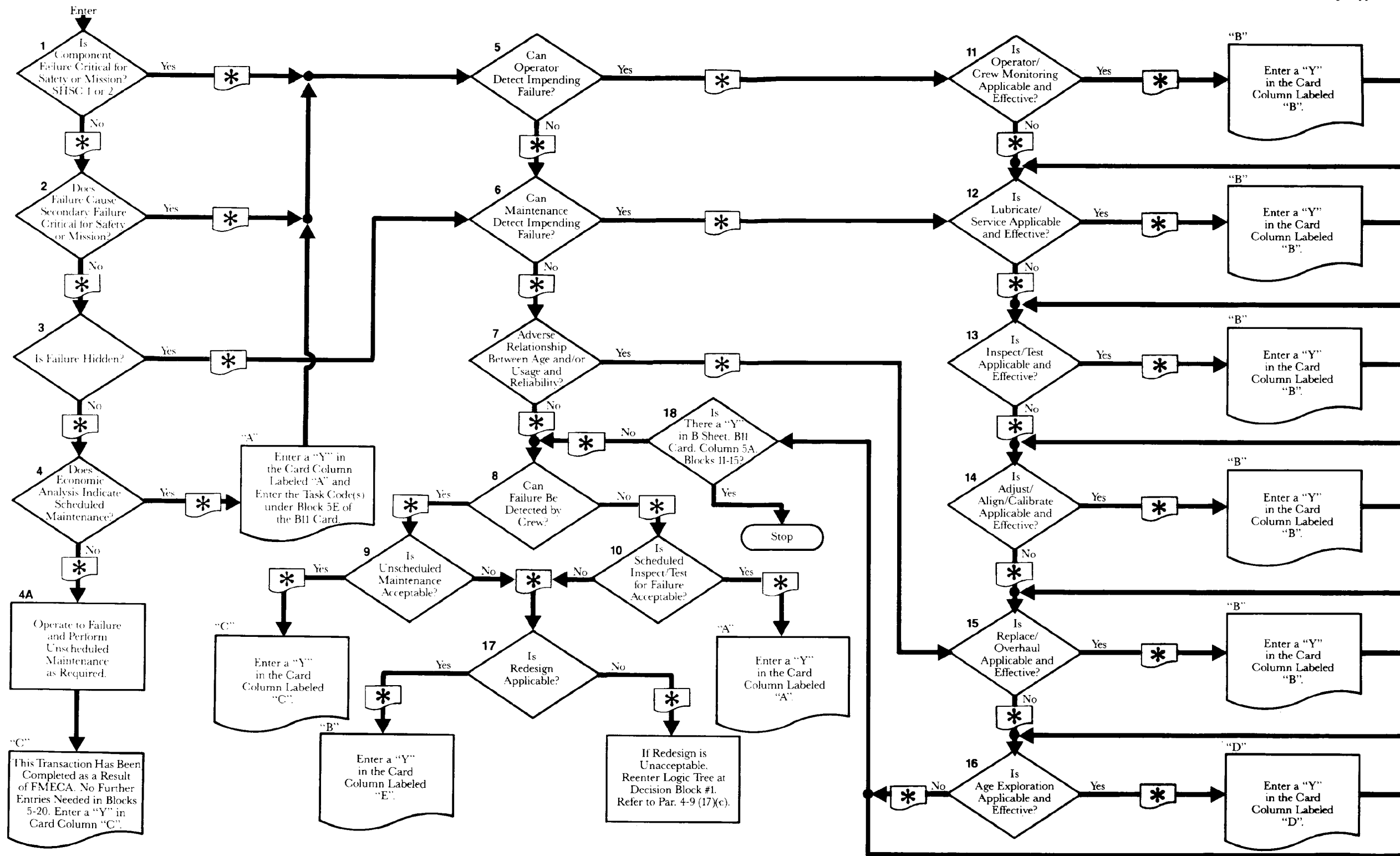


Figure 8-2. RCM Analysis Process (Ref. 4)



## DOD-HDBK-791(AM)

$MTBDE$  = mean time between downtime events, h  
 $MTTRS$  = mean time to restore system, h.

In Eq. 8-2,  $MTBDE$  includes both preventive and corrective maintenance; similarly,  $MTTRS$  includes downtime for both preventive and corrective maintenance.

It is evident from Eq. 8-1 that an increase in operating time  $OT$  for the same total maintenance downtime will result in a greater availability  $A_{a1}$ . Similarly from Eq. 8-2, a higher  $MTBDE$  for the same  $MTTRS$  will result in greater availability  $A_{a2}$ . Likewise, a lower  $TPM$  (Eq. 8-1) or  $MTTRS$  (Eq. 8-2) will result in an increased availability. The trade-off decisions involve both the determination of the most cost-effective method for achieving an improvement in reliability ( $MTBDE$ ) or maintainability ( $MTTRS$ ) and the determination of the cost-effectiveness, or value, of the resulting improvement in terms of the increased life of the equipment.

The value of increased availability must be determined on the basis of the planned use of each type of equipment. In simplest terms, increased availability can be equated to fewer required items. For example, if a requirement for helicopters stated that 200 helicopters are required and an expected availability prediction was 80%, it would be expected that only 160 helicopters would be available for use at any given time. Therefore, to be reasonably certain of having 200 helicopters in an operational state, 250 helicopters would have to be procured. In this example a 10% improvement in availability, i.e., 90%, would reduce the required procurement to 222 or by a value equal to the acquisition cost of 28 helicopters plus their operating and support costs.

### 8-3.2 COST OF OWNERSHIP

Preventive maintenance versus repairing after condition monitoring is one of the major trade-offs for determining when to perform preventive maintenance. The advantage of scheduled, on-condition maintenance is that damage would be detected when the equipment is already out of service and in a condition to permit the repair to be made. If the unavailability occurs at a random time, the cost of repair must include the cost of providing the required maintenance capability—e. g., travel time of personnel, towing cost, and travel costs—as well as the cost related to the unavailability of the equipment.

The value of performing preventive maintenance on an item in lieu of allowing the item to operate without maintenance until failure can be measured in terms of relative cost. The performance of preventive maintenance is cost-effective if the reduction in repair cost plus the equipment out-of-service cost exceeds the accrued preventive maintenance cost. The following equations illustrate this hypothesis:

$$V_{pm} = C_{pm} - C_{cm}, \text{ dollars} \quad (8-3)$$

$$C_{pm} = \frac{T}{(MTBMA)_p} [(MMH) \times C_{mh} + C_{mat}] + \frac{T}{(MTBF)_p} [MTTR) \times M \times C_{mh} + C_p], \text{ dollars} \quad (8-4)$$

$$C_{cm} = \frac{T}{(MTBF)_c} [(MTTR) \times M \times C_{mh} + C_p + C_c], \text{ dollars} \quad (8-5)$$

where

$V_{pm}$  = value of alternate maintenance concepts, dollars

$C_{pm}$  = cost of maintenance for time  $T$  with a preventive maintenance program, dollars

$C_{cm}$  = cost of corrective maintenance with no preventive maintenance program, dollars

$T$  = calendar time over which value is to be determined, h (This could be the expected life of the equipment.)

$(MTBMA)_p$  = mean time between preventive maintenance actions, h

$MMH$  = maintenance man-hours required to perform required preventive maintenance task (each time), man-hours

$C_{mh}$  = cost per man-hour to perform the preventive maintenance, dollars/man-hour

$C_{mat}$  = cost of material for each preventive maintenance action, dollars

$(MTBF)_p$  = mean time between failures for item with preventive maintenance, h

$MTTR$  = mean time to repair item to correct failure under evaluation, h

$M$  = number of persons required to repair item of equipment, men

$C_p$  = cost of replacement parts to correct failure, dollars

$(MTBF)_c$  = mean time between failures for item without preventive maintenance, h

$C_c$  = projected cost of returning item to service if failure occurs at a random time, dollars (This cost item includes such entities as towing, transport of crews and equipment, and out-of-service (loss of use) costs.)

From the standpoint of dollars only, Eq. 8-3 indicates that for a positive value of  $V_{pm}$  i.e.,  $C_{pm} > C_{cm}$ , it is better to adopt a policy of no preventive maintenance: a negative value of  $V_{pm}$  i.e.,  $C_{pm} < C_{cm}$ , indicates preventive maintenance is the better policy. Cost considerations, however, cannot be considered in isolation. Consider a

fan or alternator belt; wear to failure without preventive maintenance may be the less expensive option rather than replacement at a fixed number of miles. However, when the belt breaks even though a replacement belt and personnel are immediately available to make the repair the equipment is down for a finite time period. Depending on the circumstances, the interruption of function provided by the disabled equipment may be intolerable.

Cost-effectiveness also is a factor in evaluating a proposed change to improve the maintenance capability and or reduce the preventive maintenance requirements. The cost-saving ratio, i.e., the cost saving divided by the original cost, is a measure of maintenance cost-effectiveness. The cost of improvement includes the cost of design changes, cost of new parts and perhaps new test equipment and technical manuals, and cost of incorporation. As previously indicated, cost may not be the sole measure of effectiveness. In the example in par. 8-2.4 the question was "to redesign the equipment to provide a test or inspection capability or to live with the inherent reliability characteristics and risks". However, unless the improvement is introduced early in design, the cost of redesign and retrofit may be greater than the dollars saved by requiring less maintenance effort. Increased availability, and its value in terms of reduced equipment procurement, is often a more significant cost-saving factor than a reduction in maintenance man-hours.

## 8-4 DESIGN CONSIDERATIONS

Design considerations for preventive maintenance are generally the same as those for corrective maintenance. Access for replacement will usually provide sufficient access for periodic inspection, cleaning, and adjustment as well. Instrumentation for fault isolation can also provide for condition monitoring. Periodic servicing of equipment imposes other criteria that are discussed in the paragraphs that follow.

Servicing of mechanical equipment is important to assure that the equipment achieves the expected useful life. Ease of servicing is important in reducing downtimes and cost of ownership. A major reason for the high cost of maintenance is the repetitive frequency—some of which may be unnecessary—of service tasks. Ease of servicing is provided by ease of access to servicing points and by use of standard servicing features for a large population of items—e.g., lubrication fittings, servicing locations, common lubricants, and fuels.

Periodic servicing is important because of the possibility and danger of impairing overall weapon system effectiveness if the servicing is not performed. All military materiel is serviced on a systematic schedule. One or more of the following service operations are usually performed:

1. Lubrication—Oiling and greasing, and filling and draining
2. Cleaning and preserving
3. Adjusting and aligning.

Different types of equipment require different predominant types of service. For example, motor vehicles require frequent lubrication and occasional cleaning and

adjusting. Gun systems and missiles are more prone to require preserving, at least during peacetime. Ground test equipment requires adjusting and aligning to maintain calibration. Peacetime operations place a strong emphasis on cleaning and preserving stored equipment to prevent degradation.

### 8-4.1 LUBRICATION

#### 8-4.1.1 Oiling and Greasing

Oiling and greasing (lubrication) of equipment is of vital importance. The best designed mechanical and electric mechanical equipment can and does fail completely due to inadequate and/or improper lubrication. Lubrication is often the only maintenance required for long, maintenance-free service. Equipment designs often evolve with little thought given to the vast number of maintenance hours required in the field for periodic checking of oil levels and lubrication. Lubricant-free designs and, or rapid lubrication capability should be built into the equipment and given equal design importance with the proper functioning of the equipment. Lubrication requirements for mechanical items—bearings, gears, shafts—is usually recognized. There are particular lubrication requirements for electronic and electrical equipment. Synchronous switch shafts, generators, motors, and relay arms have been a serious source of malfunction and of subsequent destruction of the equipment.

Working surfaces subject to wear or deterioration should be provided with the appropriate means of lubrication. Lubricants, fluids, and associated products should be selected in accordance with the provisions of US Army Materiel Development and Readiness Command (DARCOM) Regulation 750-11 (Ref. 11). This regulation establishes the Belvoir RD&E Center as the AMC focal point on the proper selection and use of the packaged products it governs. In this role the center's Fuels and Lubrication Division provides the coordination and approval necessary to insure that lubricant orders and technical manuals contain only current standardized product specifications. The regulation

1. Explicitly prohibits the random introduction of proprietary products
2. Requires compelling justification for the use of nonstandard products as opposed to those qualified in accordance with military and, or federal specifications, or purchase descriptions
3. Imposes MIL-STD-838 (Ref. 12) on all designs, developments, and acquisitions
4. Insists that all procurement requests, solicitations, and contracts have lubricant order or technical manual approval before acceptance of the first unit.

From the maintainability standpoint equipment should be designed to use only one type of oil and one type of grease. The types should be the same as those for other equipment to be used in the same operational locations. Where a special lubricant is required, such as high or low temperature operational requirements, each lubrication fitting should be clearly labeled with the grease or oil

## DOD-HDBK-791(AM)

specification letters 6.4 mm (0.25 in.) high; the label should be placed as close to the fitting as is suitable.

In applications requiring a high load-carrying capacity with minimum space requirements, bearings containing their own supply of lubricants are highly desirable. However, these bearings should be provided with some means of external relubrication, e.g., the oil hole maybe through a synthetic seal pierced by a hypodermic needle or an entrance may be drilled in the bearing and lead out to an easily accessible point on the housing. The loss of lubricant back through an oil hole so provided or the entrance of contaminants into the lubricant must be avoided.

The lubrication of aircraft equipment is most important due to possible wide variations in temperature within a short time.

Equipment should be designed to use the minimum number of lubrication fittings, and they should be of the same size and of a standard type. Typical shapes of lubrication fittings are illustrated in Fig. 8-4. All grease fittings should conform to specification MIL-F-3541 (Ref. 13), and all electronic lubrication designs should conform to MIL-STD-454 (Ref. 14).

Grease fittings should be readily and easily accessible and positioned to provide positive mating with the grease pressure gun. Where a grease location is not easily accessible, extension lines should be built into the equipment to bring the grease fitting to an accessible location on the outside of the equipment. The fitting end of the line should be securely anchored to withstand rough use. The use of grease cups, exposed oil holes, and oil cups should be avoided.

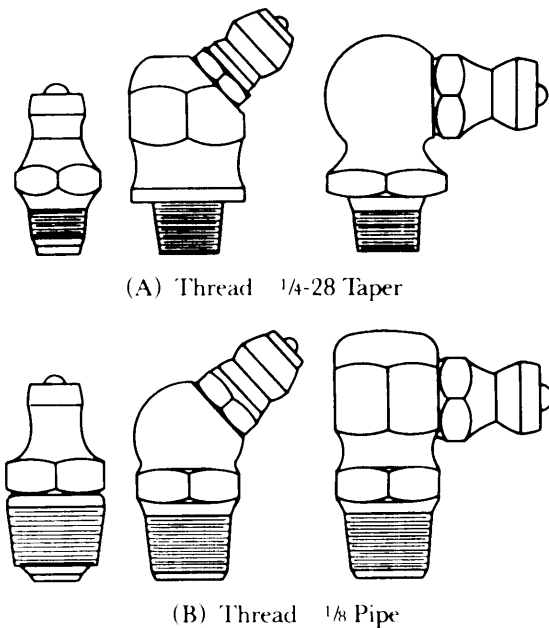
The following design features relating to lubricants and lubrication fittings are recommended:

1. Consider the use of a central mechanism for applying lubricant.

2. Provide lubrication fittings and reservoirs for all types of plain annular and plain self-aligning bearing installations as shown in Fig. 8-5. It is not necessary to provide a means for lubricating plain bearings fabricated of oil-impregnated sintered metal (bronze or iron), provided the bearings are not expected to maintain lubricity beyond the life of the lubricant with which they are impregnated. Where the amount of lubricant contained in the bearing is not sufficient to last for the life required, provide lubrication fittings or reservoirs to contact the outer surface of the sintered bearing. Incorporate sealing provisions in all plain bearing installations to prevent the progress of contamination between the moving surfaces and into the lubricant.

3. Oil seals should be easy to replace. Design to avoid blind fitting. Seal seatings and lands should be provided with adequate openings for driving the seals out. Oil seals should retain their elasticity during long periods of storage.

4. Dipsticks should be provided for measuring oil levels. They should be graduated to show the amount required for filling. Contrast between the finish of the gage and clear, thin oil should be provided by specifying a roughened surface or metal with a dark, dull finish. Locate oil dipsticks and other level indicators so that they



**Figure 8-4. Typical Lubrication Fittings**

may be fully withdrawn without touching other pieces of equipment and away from hot areas of engines.

5. Provide magnetic chip detectors equipped with warning lights, rather than electrical detectors, in lubricating systems. Most electrical chip detectors require complete oil drainage; however, it is unnecessary to drain the oil when inspecting magnetic chip detectors. In electrical detectors particles similar to carbon sludge or graphite although harmless to engine operation will produce an indication of the test light, i.e., falsely indicate a maintenance problem. Magnetic plugs should conform to Military Standard MS-35844 (Ref. 15) and should be used as practical throughout all fluid handling systems. Particular attention should be given to sumps or crankcases, gearboxes, positive displacement pump inlets, and wherever iron or steel chips may endanger the life or operation of equipment.

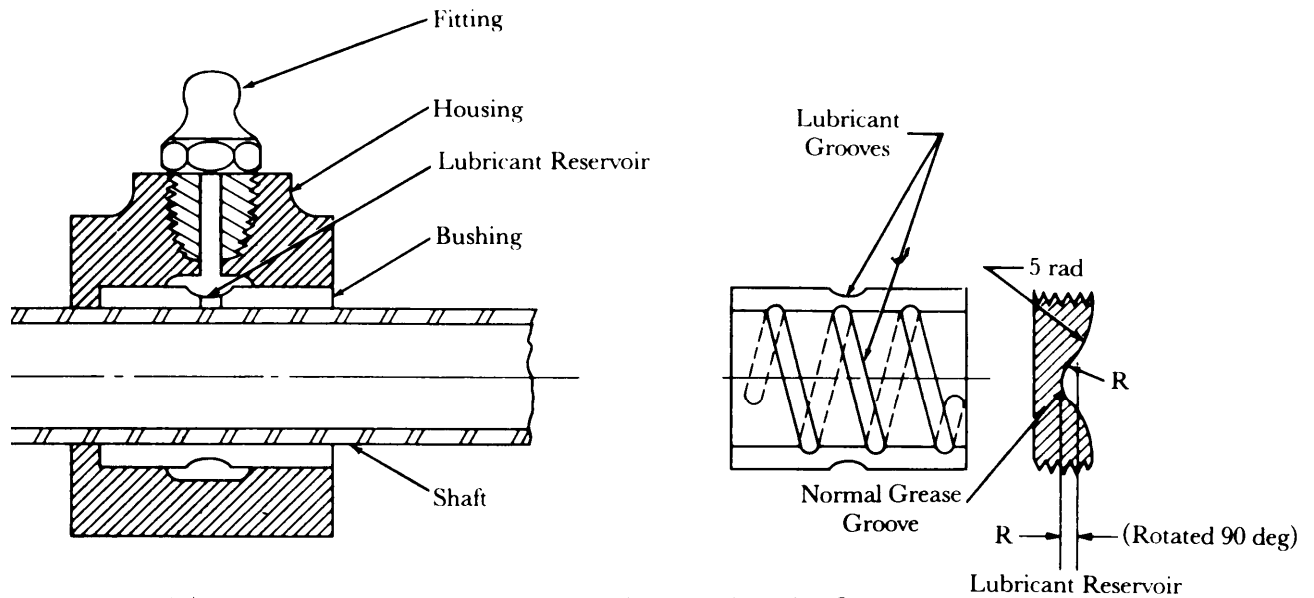
6. Design equipment to operate on as few different types and grades of standard lubricants as possible. Oil filters should be standard in range and size, and filter elements should be easily removed and replaced.

7. Avoid designs that require high-pressure lubricants.

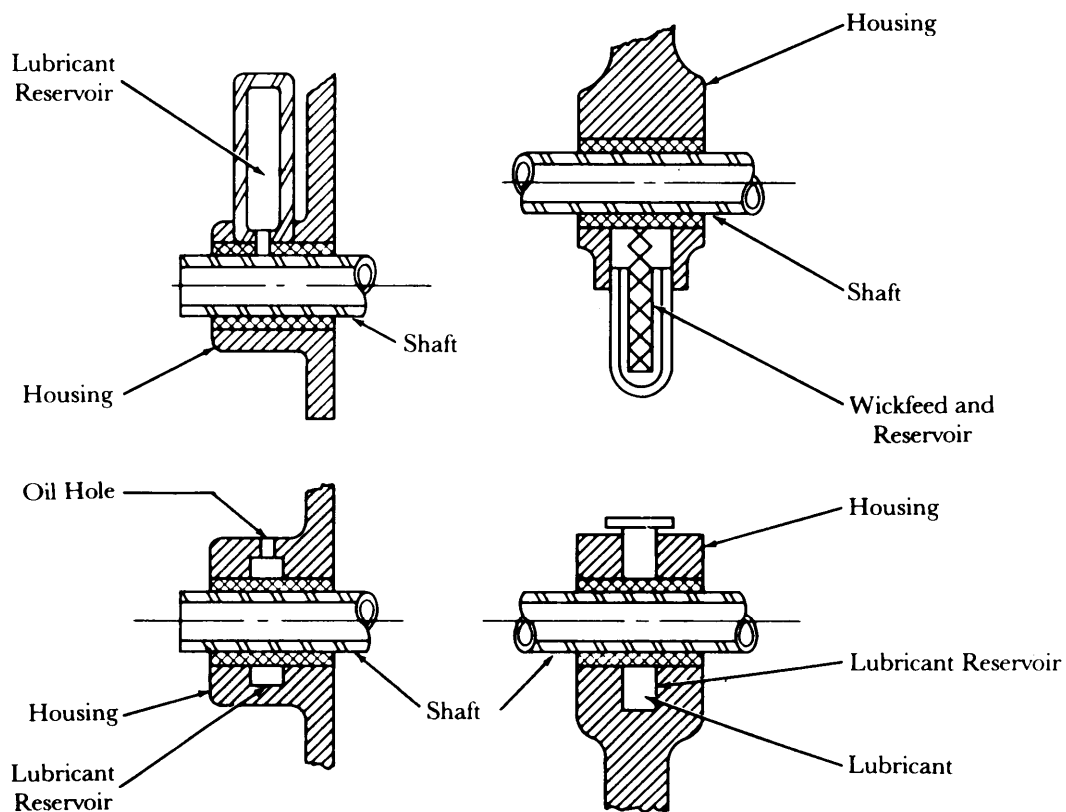
8. A built-in, automatic lubrication system is desirable for a piece of equipment that must operate continuously for long periods of time, especially in dusty conditions, or when its lubricants tend to be forced from bearing surfaces by heavy impact or vibration loads.

9. Provide a schedule for all lubrication requirements that shows the frequency of lubrication, the type of lubricant, specific points requiring lubrication, methods, and the cautions to be observed.

10. Provide adapters to permit the use of equipment with conventional filler parts when using pressure oiling instead of the gravity-fill method.



(A) Lubrication Fitting, Lubricant Reservoir, and Lubrication Grooves for Plain Bearing-Bushing Installation



(B) Lubrication Fitting and Lubrication Reservoir for Sintered-Bearing Installation

Figure 8-5. Bearing Lubrication Methods

## DOD-HDBK-791(AM)

11. Select a lubricant, when possible, that can be used in a given piece of equipment for both operational and storage purposes. Consider the use of prelubricated gears and bearings, packaged in plastic, to meet this requirement.

12. Provide easy access to the equipment for direct lubrication if lubrication points are not feasible.

13. Design lubrication points with a reservoir area to reduce the frequency of required lubrication.

14. Provide guards around lubrication points that may require servicing while equipment is operating to prevent accidental insertion of hands or tools into operating equipment.

Lubrication charts should be provided with each piece of equipment. The material of the chart should be waterproof and oilproof, and the chart should be printed on material suitable for rough handling. All necessary information for lubrication, including specification numbers, should be included on the charts in the largest letters that the size of the chart will permit. Suggested lubrication time intervals should also be included. Fig. 8-6 is an example of a lubrication order.

### 8-4.1.2 Army Oil Analysis Program (AOAP)

The policies and procedures governing the Army oil Analysis Program (AOAP) are described in AR 750-22 (Ref. 16). The objectives of the AOAP are

1. Improve operational readiness of Army equipment
2. Promote safety
3. Detect impending component failures in time to avoid more costly and extensive repairs
4. Conserve lubricating and hydraulic oils by applying on-conditional oil changes.

All Army aircraft and those nonaeronautical systems specified in TB 43-0210 (Ref. 17) are enrolled in the AOAP. Each month thousands of lubricating and hydraulic oils are analyzed at AOAP laboratories at specified intervals for contamination and wear-metal concentrations. By means of these tests the technicians can determine equipment parts that show signs of possible malfunction. Water seepage, rust particles, and oil dilution are additional problems that surface. Detailed operating procedures for the AOAP are contained in TB 43-0106 (Ref. 18) and TB 43-0210 (Ref. 17). The AOAP is a major contribution for improving preventive maintenance procedures.

The US Army Materiel Command is charged with exercising staff supervision over the AOAP.

## 8-4.2 FILLING AND DRAINING

### 8-4.2.1 General

No repeated operation of maintenance should be given more attention than the details relating to the ease and rapidity of refueling and reoiling. Fuel, exotic fluids and gases, oil, hydraulic fluids, water, and compressed air systems should be redesigned to permit the most rapid, total overall inspection. The necessity for opening doors and

hatches for inspection or to gain access to service points or filler caps should be reduced. Servicing points for checking, filling, and draining fuel, lubricant, hydraulic fluid, and coolant should be readily accessible, but protected. The need for special tools should also be eliminated wherever possible.

Vehicular fuel tanks should be designed and fabricated to eliminate or minimize internal corrosion when in use or in storage (empty), and the interiors of tanks should be accessible for inspection and cleaning.

### 8-4.2.2 Filling Requirements

The design recommendations that follow should be considered:

1. The fuel outlet should be located at least 19 mm (0.75 in.) above the bottom of the sump or tank or at the bottom of the sump or tank with a 19-mm (0.75-in.) stand pipe.

2. The fuel tanks should be capable of accepting fuel at 198  $l/min$  (50 gpm) when tank capacity exceeds 189  $l$  (50 gal). Tanks having capacities of less than 189  $l$  (50 gal) should be capable of being filled at the 189- $l/min$  (50-gpm) rate when using a standard 35-mm (1.375-in.) diameter nozzle that is 406 mm (16 in.) long. The filler neck should have a flexible seal to fit such a nozzle and an opening other than the filler neck itself for venting displaced air.

3. The tank filler should be located to prevent to the maximum extent possible entrance of dirt, water, and foreign matter into the fuel tank.

4. For gravity-filled tanks the tank filler should be located to permit use of 3.8- to 18.9- $l$  (1- to 5-gal) cans as well as forced-nozzle filling. Filler necks should also be located to permit use of rigid spout fuel nozzles conforming to MS-17967 (Ref. 19).

5. Fuel filler neck dimension should be a minimum of 44.5 mm (1.75 in.) for fuel tanks of 95- $l$  (25-gal) capacity or less, and 63.5 mm (2.5 in.) for larger fuel tanks. Water and coolant filler necks should have a minimum diameter of 38 mm (1.5 in.) and should be located so they can be serviced with an 18.9- $l$  (5-gal) can conforming to MIL-C-13984 (Ref. 20).

6. The type of fuel to be used and the tank capacity should be stenciled or marked adjacent to the filler opening of the equipment.

7. Fuel, oil, and coolant filler caps should be color coded as shown in Table 8-1.

8. Locate the hydraulic reservoir so that it is visually accessible for refilling. Also the fluid level should be visible while filling.

9. Level indicators of the type indicated by Fig. 8-7 for fuels, oils, water, or other liquids should be located outside of the vehicle or tank, when possible, and should be easily viewed without removal of doors or covers. For level indication of infrequently checked units, such as gearboxes, dipsticks with integral sealing caps should be provided. The use of threaded plugs for level indication should be confined to such locations as automotive differentials because at such locations other types should be torn off by rocks, mud, or stumps. When such plugs are

LUBRICATION ORDER

LO 9-2350-253-12

31 OCTOBER 1979

TANK, COMBAT, FULL-TRACKED, 105-MM GUN, M60A3  
(2350-00-148-6548 AND 2350-01-061-2306 TTS)

Reference: TM 9-2350-253-10, TM 9-2350-253-20-1 and -2

Intervals and the related manhour times are based on normal operation. The manhour time specified is the time you need to do all the services prescribed for a particular interval. Change the interval if your lubricants are contaminated or if you are operating the equipment under adverse operating conditions, including longer-than-usual operating hours. You may extend the interval during periods of low activity, but you must take adequate preservation precautions.

Park vehicle on level ground to check oil levels. Clean fittings before and after lubricating with a dry, lint-free cloth. Lubricate all items found contaminated after fording or washing. Broken arrow shafts indicate lubrication points on both sides of the vehicle. Level of maintenance for lubrication requirements is indicated at note reference by (C) for Crew/Operator, and (O) for Organizational Maintenance.

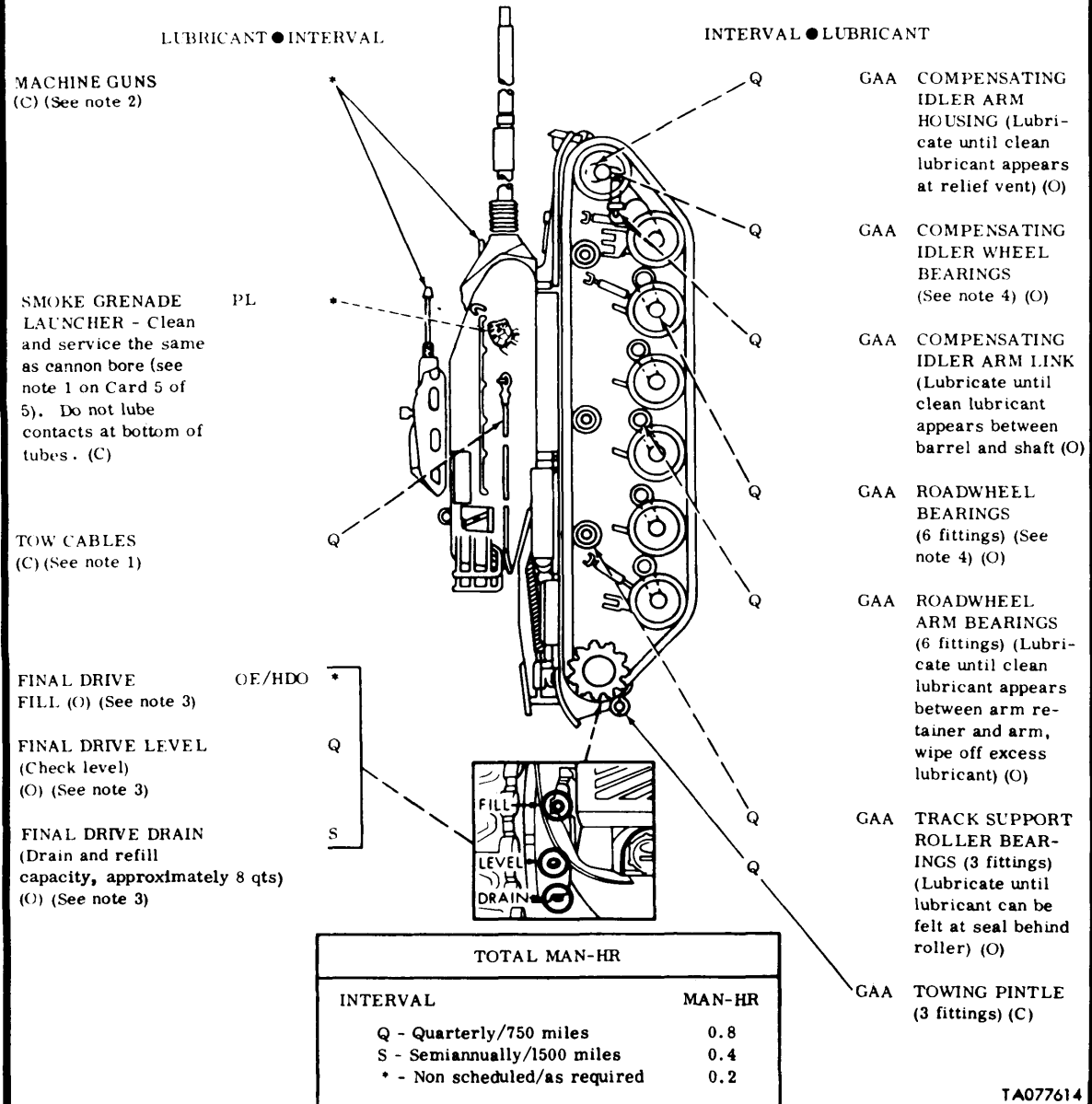


Figure 8-6. Example of a Lubrication Order

(cont'd on next page)

KEY		EXPECTED TEMPERATURES		
LUBRICANTS/COMPONENTS		Above +32° F	+40° F to -10° F	0° F to -65° F
OE/HDO - Oil, Engine, Heavy Duty MIL-L-2104				
OEA-Oil, Engine, Subzero, MIL-L-46167				
Final Drive		OE/HDO-50	OE/HDO-10	OEA
Oil Can Points		OE/HDO-30		
GAA-Grease, Automotive and Artillery MIL-G-10924		All temperatures		
Track Support Roller Bearings				
Compensating Idler Arm Housing				
Compensating Idler Wheel Bearings				
Compensating Idler Arm Link				
Roadwheel Bearings				
Roadwheel Arm Bearings				
Towing Pintle				
LSA-Oil, Lubricating, Semi-Fluid MIL-L-46000				
PL-M-Oil, Lubricating, Preservative MIL-L-3150		PL-M		
PL-S-Oil, Lubricating, General Purpose VV-L-800			PL-S	PL-S
LAW-Oil, Lubricating, Weapon MIL-L-14107			LAW	LAW
Machine Guns		See note 2		

For Arctic Operation, refer to TM 9-207

NOTES

1. TOW CABLES. Clean cables with drycleaning solvent, Type II (SD-2), P-D-680, and coat with corrosion preventive compound MIL-C-16173 (Grade 1).
2. MACHINE GUN LUBRICATION. As soon as possible after firing, and on three consecutive days clean all powder-fouled surfaces with rifle-bore cleaning compound, (RBCC) MIL-C-372. Disassemble into major components, clean with drycleaning solvent, Type II (SD-2), P-D-680, wipe dry, and oil. Do not overlubricate, DO NOT oil solenoids and DO NOT dip backplates with solenoids into any solution; clean with a swab or clean dry cloth. Apply lubricants sparingly in grooves, camways, rails, rollers, covers and receiver assemblies. Cycle function components by hand to spread the oil. Thereafter, clean and oil every 90 days unless inspection reveals shorter intervals are required. Remove oil from barrel before firing. NOTE. For more detailed lubrication instructions see TM 9-1005-231-10 for M85 (caliber .50 machine gun) and TM 9-1005-313-10 for M240 (7.62-mm machine gun).
3. FINAL DRIVES. Check oil level quarterly. Check before operating vehicle when oil is cold. To check oil level, remove the oil level plug. If final drive has been overfilled, allow excess oil to drain into a suitable container. It is normal for a small quantity of oil (approximately two or three tablespoons) trapped behind the plug to run out as the plug is removed. Assure that the oil level is up to the lower edge of the plug hole. This may be done by carefully inserting the finger into the level plug hole and feeling for the oil. If oil level is low, install level plug, remove fill plug, add oil, and allow to settle. Recheck level. Repeat procedure, as necessary, until proper level is reached. DO NOT OVERFILL. Clean and install fill and level plugs. Drain every 1,500 miles or semiannually, whichever occurs first. Semiannual changes are to be coordinated with seasonal changes when possible. To drain, remove drain plug from bottom of housing. Drain only after operation while oil is warm. After draining, clean and install drain plug. Refill to proper level as outlined above.
4. COMPENSATING IDLER WHEEL BEARINGS AND ROADWHEEL BEARINGS. Clean grease from seal assembly. Clean lubricant pressure relief fitting using a clean, lint-free, dry cloth. Check lubricating pressure relief fittings for proper operation. The plunger type fittings are checked by pulling up on the plunger. The plunger should move freely. The ball-type fittings should be checked to insure that the two relief ports are open. If necessary, remove fittings, clean thoroughly in drycleaning solvent, Type II (SD-2), P-D-680, and dry with compressed air or a clean, lint-free cloth. Verify that plunger or ball moves freely before reinstalling fitting. Apply lubricant until it appears at lubricant pressure relief fitting. No lubricant should appear at seal assembly.
5. OIL CAN POINTS. Quarterly, lubricate headlight removal nuts, fender stowage box latches and hinges, interphone box hinge, gun travel lock hinges and bolt, towing hooks (hinge pin), grille door hinges, control rod clevises, brake linkage and transmission support guide rails and rollers, driver's, gunner's and commander's seat moving parts, periscope cover hinges and periscope hatch mounts, hatch locks and hinges, driver's escape hatch (clean and coat pins, plungers and all unpainted surfaces), manual elevating and traversing handles and universal joints, ammunition rack retainers, ammunition box latches, and cupola machine gun access door locks. On vehicles equipped with AN/VVS-2 driver's night vision viewer, quarterly lubricate viewer hatch door pivot pin and latch.
6. DO NOT LUBRICATE. Machine gun solenoid, starter solenoid, air cleaner blower motor, hydraulic power pack electric motor, heater motor, ventilator blower motor, or gas particulate fan motor, tracks, tachometer drive adapter, electric firing circuit contacts, breechblock firing pin, or any item not pointed out in this lubrication order.

TA077615

Figure 8-6 (cont'd)

**TABLE 8-1. COLOR CODE FOR FILLER CAPS**

<u>Cap Function</u>	<u>Color</u>	<u>FED-STD-595 No. (Ref. 21)</u>
Fuel	Insignia Red	11136
Oil	Orange Yellow	13538
Coolant	White	17875

used, they should have the wrench projection accurately made to fit standard end socket wrenches and should be sufficiently long to obtain full bearing area on a wrench.

10. Design fuel and oil tank filler caps for aircraft so they cannot be improperly secured to filler necks and cannot come off in flight. If the cap comes off in flight, fuel or oil can be siphoned overboard. Use of spring-loaded locking caps will reduce the risk of cap loss.

**8-4.2.3 Draining Requirements**

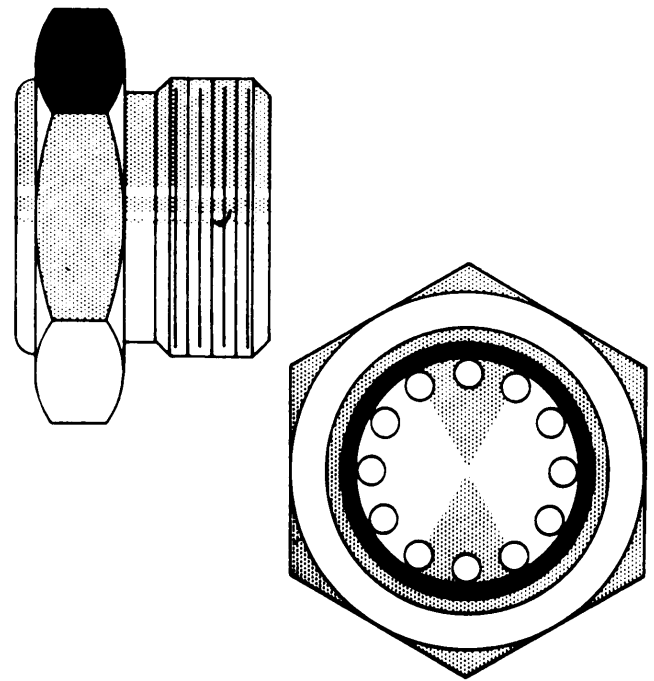
Consider the following design recommendations for the draining of tanks:

1. The fuel system should be easily drained for storage and cleaning. Fuel filters should be located so that they can be cleaned and replaced without disassembly of other parts.

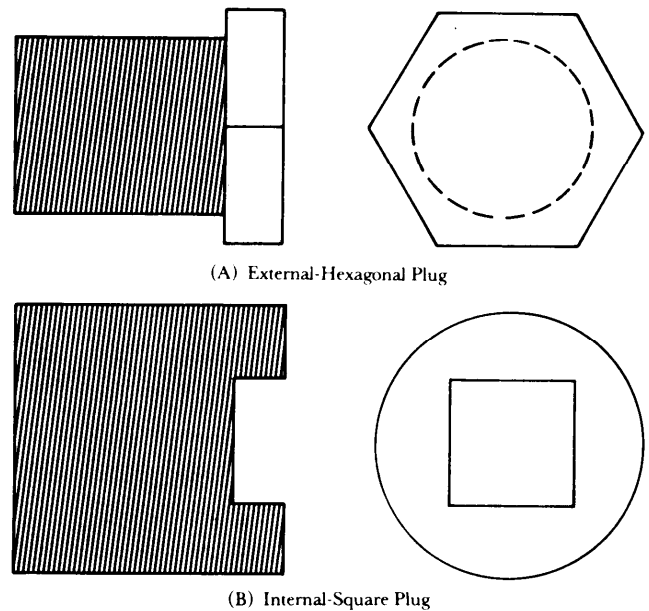
2. Provide each fuel tank with a sump located at the lowest portion of the tank when the equipment is in its normal position. The sump, used for collecting sediment and water, may be combined with the fuel tank outlet. Provide a machine-threaded drain plug or self-locking drain valve at the lowest point of the tank. The sump drain should be made accessible to personnel wearing heavy, winter gloves and should not require the use of special tools.

3. When it is essential to avoid overfilling, accessible level plugs as shown in Fig. 8-7 maybe used. External-hexagonal plugs (Fig. 8-8(A)) are desirable because the hexagonal head provides ample surfaces on which to get sufficient purchase to maneuver the plug, particularly in a confined space. The internal-square plug (Fig. 8-8(B)) should be used where the plug must be flush with the surrounding surface. Drain cocks that provide a high rate of drainage should be fitted to all air receivers and oil reservoirs. All drain cocks should be designed to be closed when the handle is in the down position to prevent accidental opening.

4. Drain holes large enough to facilitate cleaning should be provided wherever water is likely to collect. Provide drainage facilities in enclosed equipment that might be subject to accumulated moisture resulting from condensation or other causes. Provide adequate drain tubes or channels to carry the liquids to a safe distance outside the unit. An appropriate drain valve may be selected from conventional sizes shown in Table 8-2. When selecting drain valves, consider the galvanic series of metals to reduce the effects of corrosion between the drain valve and the metal to which it is attached. The electromotive series shown in Fig. 8-9 (Ref. 22) reveals the relative electromotive potential of variations of various

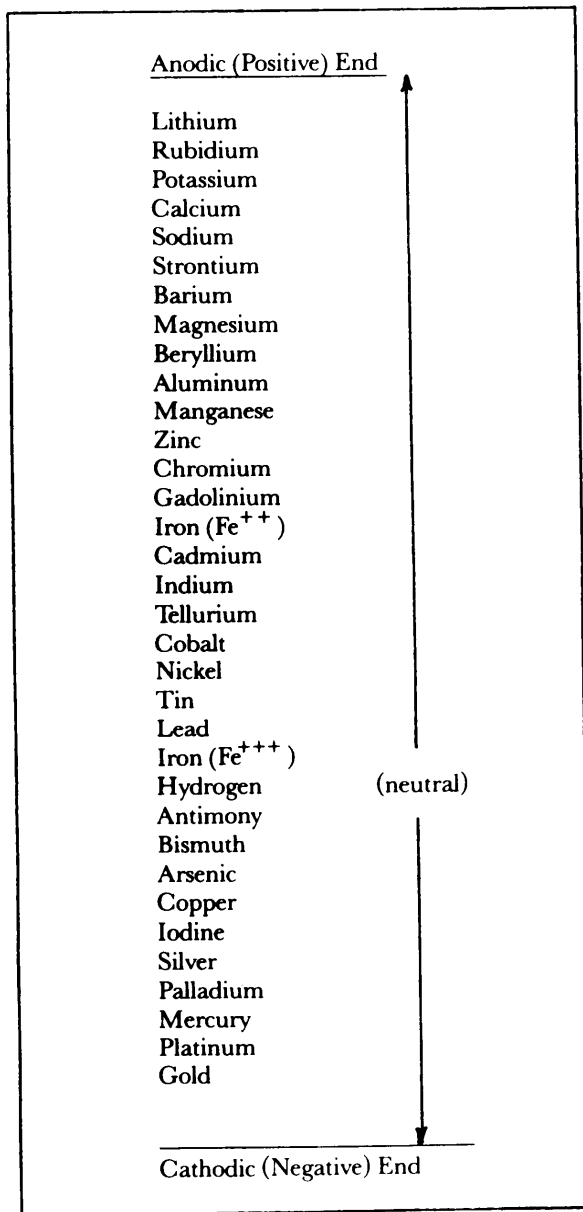


**Figure 8-7. Oil Level Sight Plugs**



**Figure 8-8. Drain Plug Heads**

**TABLE 8-2. DRAIN VALVES**



**Figure 8-9. Electromotive Series (Ref. 22)**

metals. Table 8-3 (Ref. 22) lists the galvanic series for a variety of metals and alloys in sea water. Usually the greater the separation of two bare metals of this series in contact with each other, the greater will be the corrosion problem.

5. Tank and reservoir drain valves should be located so that they maybe removed from the outside to eliminate the need to enter the tank or reservoir to remove or maintain the valves.

Aircraft drainage presents a particular problem. Drainage should be provided in wings, bodies, and control surfaces to prevent the collection of unwanted fluids, including water, from condensation within the aircraft. Consider the following design recommendations:

1. Use drain holes in the skin and limberholes in

**TABLE 8-3. GALVANIC SERIES IN SEA WATER (Ref. 22)**

1. Magnesium
2. Magnesium alloys
3. Zinc
4. Galvanized steel
5. Aluminum (52SH, 61S, 3S, 2S, 53ST in this order)
6. Aluminum clad, 24 ST, 17ST
7. Cadmium
8. Aluminum (75 ST, A 17 ST, 17 ST, 24ST in this order)
9. Mild steel
10. Wrought iron
11. Cast iron
12. Ni-Resist
13. 13% chromium stainless steel, type 410 (active)
14. 50-50 lead-tin solder
15. 18-8 stainless steel, type 304 (active)
16. 18-8-3 stainless steel, type 316 (active)
17. Lead
18. Tin
19. Muntz metal
20. Manganese bronze
21. Naval brass
22. Nickel (active)
23. Inconel (active)
24. Yellow brass
25. Admiralty brass
26. Aluminum bronze
27. Red brass
28. Copper
29. Silicon bronze
30. Ambrac
31. 70-30 copper nickel
32. Comp. G-bronze
33. Comp. M-bronze
34. Nickel (passive)
35. Inconel (passive)
36. Monel
37. 18-8 stainless steel, type 396 (passive)
38. 18-8-3 stainless steel, type 316 (passive)

bulkheads or stiffeners to permit the unwanted fluids to run to low points when the aircraft is resting in a normal position.

2. Locate drain holes judiciously so that only a few are required and a scavenging suction is produced in flight.

3. Where fabric covering is used, install grommets for drainage purposes.

4. It is sometimes desirable to group a number of drain lines into a common outlet to alleviate congestion and to obtain the most direct and efficient routing of lines. To reduce fire hazards, adhere to the following requirements:

a. Do not interconnect drain lines for electrical accessories with lines draining fuel, oil, hydraulic fluid, water-alcohol solution, etc.

b. Other accessory drains unless return of one fluid may damage any of the components of these

drains—may be interconnected provided line sizes adequately insure proper drainage.

5. Provide adequate ventilation and drainage of all interior areas to prevent the accumulation of toxic or irritating gases, liquids, and explosive mixtures.

### 8-4.3 CLEANING AND PRESERVING

Vehicles, weapons, and weapon systems will require cleaning at some time during their service life. Therefore, equipment should be designed to require a minimum of manpower, supplies, and equipment for cleaning, preserving, and refinishing.

Equipment ordinarily should not require protective processing more often than once each six months while in storage. Eliminate requirements for special protection or processing for storage by using designs featuring built-in corrosion deterioration protection.

#### 8-4.3.1 Cleaning

Exposed surfaces should be shaped to avoid recesses that collect and retain dirt, water, servicing fluids (spilled in servicing or lost in operation), cleaning solutions, and other foreign materials. Where such recesses cannot be avoided, suitable deflectors and drains should be provided.

Where feasible, design equipment to permit the use of ultrasonic cleaning of parts. In addition to speed of operation, ultrasonic equipment has the advantage of eliminating the toxic cleaning fluids and the soaking in cleaning tanks containing alkaline solutions. To reduce fire hazards, provide tight-fitting metal covers for the petroleum solvent tanks when they are not in use. Nonflammable solvents should be used wherever possible.

It should be possible to steam clean the external parts of all vehicles, weapons, or weapon systems. This applies also to tanks, pumps, valves, filter bodies, accumulators, and cylinders used with common fuels, exotic fluids, oils, water, air, and gases. Materials not suitable for steam cleaning, such as upholstery and soft linings of vehicles, should be washable with strong detergents and water or with nonflammable solvents. Consideration should also be given to the cleaning, and to the resistance to cleaning, required when, for example, a hydraulic component leaks and coats everything in a compartment with oil.

Engine parts are commonly cleaned in alkaline cleaning solutions compounded for steel components. Brass parts, such as block core plugs (freeze plugs), are not seriously affected by alkaline solutions. Aluminum components, however, are affected by alkaline solutions and, therefore, should not be used as spacers or brackets.

If delicate equipment is located in an area that will be subjected to steam cleaning, the housings should be designed to close tightly to insure that steam cleaning or sprayed solvents will not damage the internal components.

#### 8-4.3.2 Preserving

Consider the use of preservative materials for the following items:

1. Surfaces subject to rubbing and chipping
2. Fastenings and small parts in hidden locations
3. Hidden surfaces whose complex shape or inaccessible location make them difficult to prepare and refinish
4. Small, light parts, such as those made of sheet metal and other thin-gage materials.

Specify ozone-resistant compounding for all rubber components that are exposed to the atmosphere. Otherwise, these components must be specially preserved during storage to prevent deterioration.

There is a definite correlation between climate and deterioration of materials; an unfriendly environment increases the maintenance burden. The full range of military environments is contained in MIL-STD-210 (Ref. 23). Tropical climates—characterized by high ambient temperature and high humidity—present the most severe test for preservation measures. A tropical climate is defined as one in which the mean monthly temperature never goes below 18.2°C (64.9°F). The following major problems are associated with tropical areas:

1. Corrosion of steel and copper alloys caused by electrolytic action
2. Fungous growth on organic materials such as canvas, felt, gasket materials, sealing compounds, and even on the optical elements of fire control equipment
3. Deterioration through corrosion and fungous growth in insulation, generating and charging sets, demolition and mine detection equipment, meters, dry cell batteries, storage batteries, cables, and a variety of lesser components.

Since fungi can cause corrosion, rotting, and weakening of materials, materials inert to the growth of fungi should be used whenever possible in the design of US Army equipment. In general, synthetic resins—such as melamine, silicone, phenolic, and fluorinated ethylenic polymers with inert fillers, such as glass, mica, asbestos, and certain metallic oxides—provide good resistance to fungous growth. Not all rubber is fungous resistant, and antifungous coatings generally are impractical for this material. When fungous-resistant rubber is needed, it should be so specified to insure that the manufacturer furnishes a suitable compound.

Termites attack all wooden parts not impregnated with a repellent agent, and they are especially attracted to plywood bonded with a vegetable glue.

Selected materials should be corrosion resistant, or they should be protected by plating, painting, anodizing, or by some other surface treatment to resist corrosion. Surfaces required to be acid proof should be given additional surface treatment. Treatment should be selected in accordance with MIL-S-5002 (Ref. 24). The use of any protective coating that will crack, chip, or scale with age or extremes of climatic and environmental conditions should be avoided.

It is difficult to make definite comparisons of the corrosion-resistant properties of metals because the resistance of each varies with the chemical environments. However, in vehicle design the metals most commonly used for their corrosion-resistant properties are—not in order of resistance—titanium, molybdenum alloys, stainless steel, pure aluminum, cadmium, chromium, zinc, nickel, tin, and copper alloys. The aluminum and magnesium alloys are seriously degraded by corrosion and should be avoided. The automobile manufacturers have introduced zinc plating—either galvanizing or electroplating—of steel body panels and mufflers to increase corrosion resistance.

Dissimilar metals that are far apart in the galvanic series—see Fig. 8-8 and Table 8-3—should not be directly joined together, but if they must be used together, their joining surfaces should be separated by an insulating material or both surfaces must be covered with the same protective coating.

For more detailed coverage of corrosion and the corrosion protection of metals, see MIL-E-5400 (Ref. 25) and Refs. 26, 27, 28, and 29 for listings of acceptable corrosion-resistant materials.

### 8-4.4 MOISTURE PROTECTION

The exclusion of moisture from equipment, particularly in the tropics, considerably eases maintenance problems. To help minimize the effects of moisture on insulating and other materials, the guidelines that follow should be considered:

1. Choose materials with low moisture absorption qualities.
2. Use hermetic sealing whenever possible.
3. Use gaskets and other sealing devices to keep moisture out.
4. Impregnate or encapsulate materials with fungus-resistant hydrocarbon waxes and varnishes.
5. Do not place bare metal parts in contact with materials that have been waterproofed; metal may support fungous growth and deposit corrosive waste products on the treated material.
6. When waterproofed materials are used, be sure they do not contribute to corrosion or alter electrical or physical properties.

If these methods are not practical, drain holes should be provided, and chassis and racks should be channeled to prevent moisture traps. Additional information on moisture protection can be supplied by the Prevention of Deterioration Center, National Research Council, 2101 Constitution Avenue, Washington, DC 20037. Refer also to MIL-E-5400 (Ref. 25) for listings of acceptable moisture-resistant materials.

### 8-4.5 ADJUSTMENT AND ALIGNMENT

Although many types of equipment may require adjustment and alignment during their useful life, tank automotive equipment and aircraft are the most affected by this requirement. Items that require adjustments include tank treads, engine timing (gasoline engines), alternator belt

drives, and cam drive belts. Aligning applies to steering and headlights on automotive equipment and to firing controls and sights on guns. Some alignment and adjustment requirements are associated with initial installation; however, because many components have a long, useful life before wear-out, periodic inspections and adjustments are necessary to assure proper functioning. When mechanical components have actuating linkages, e.g., throttle controls and flight controls on aircraft, the control at the component and the component itself should incorporate alignment positioning pins to assist in the rapid attachment and proper positioning of the control without two-person cooperation.

Equipment should be redesigned to require the minimum number of periodic maintenance adjustments. However, maintenance adjustments that cannot feasibly be eliminated should be simplified enough to permit their accomplishment at the lowest practicable maintenance level. The use of built-in, self-adjusting devices should be considered provided their addition does not present a maintenance burden more difficult than manual adjustment.

If adjustments are to be made manually, insure that disassembly of the components is not required for their accomplishment. Wherever practicable, the effect of manipulating the service adjustments should be clearly and easily discernible by reference to appropriate gages or other displays. Avoid critical adjustments, i.e., a slight manipulation of the device (or slight variation during normal operation) that will cause a very large change of the affected parameter. Adjustment devices should have an adequate range of adjustment without being unduly critical or dependent on other adjustments. Maladjustments that may occur during a servicing procedure should not result in damage to any parts when the equipment is operated under the maladjusted conditions for a period of up to 5 min. In general, the range of control of service adjustments should be such as to prevent damage by maladjustment.

Alignment and adjustment devices should be neither so fine that a number of turns is required to obtain a peak value nor so coarse that a peak is quickly passed, which would necessitate delicate adjustment. Part selection and system design should provide a straightforward alignment procedure. It should be unnecessary to go back to readjust or realign earlier stages after alignments or adjustments are made to later stages. Also it should be possible to make all alignment adjustments without removal of any case, cover, or shield that would affect the accuracy of alignment upon replacement, and no special tools should be required for alignment or adjustment.

Alignment and adjustment devices should be located so they can be readily operated while the technician is observing the displays associated with the function being adjusted. It should be possible to check and adjust each unit of system separately and then connect the units into a total, functioning system with little or no additional adjustment required.

Components should be designed with the minimum number of pivots and bearing surfaces that wear and

require periodic adjustment. Any alignment or adjustment devices that are susceptible to vibration or shock should have a positive locking device to assure retention of settings. The locking device should be easy to apply and release, and the application and release of the lock should not affect the setting of the adjustment. Traveling clamps and locking devices should be designed to avoid inadvertent release.

Spindles for adjustments may be slotted, but the head should be strong enough to withstand many manipulations with a screwdriver. A method of locating and holding the adjusting screwdriver while in use is desirable. If adjustments must be made blindly, design the head to accommodate a wrench to facilitate adjustment.

Consider the use of locked-nut-and-thread adjustments instead of shims. Avoid shim-type adjustments that perform the dual function of adjusting bearings and positioning units. Where corrosion of nuts and threads may be a factor in the adjustment of large components, use corrosion-resistant materials.

Where applicable, use variable pitch, V-belt drivers for high-speed applications. Use spring-loaded idler sprockets on chain drives to avoid frequent adjustments. Eliminate adjustment of hose fasteners used in low-pressure applications (air ducts) by using spring-type fasteners that maintain a constant peripheral pressure. When enclosed chain drives require periodic adjustment, automatic adjusters should be provided.

## 8-5 PREVENTIVE MAINTENANCE AND SERVICING DESIGN CHECKLIST

Table 8-4 is a checklist summarizing the design recommendations presented in this chapter. The checklist contains several items that were not discussed separately in the text. These items are included here because their necessity in the design is so obvious that they might be inadvertently overlooked. If the answer to any question in the checklist is "no", the design should be restudied to ascertain the need for correction.

**TABLE 8-4. PREVENTIVE MAINTENANCE AND SERVICING DESIGN CHECKLIST**

1. Are standard lubrication fittings used so that no special extensions or fittings are required?
2. Are standard lubricants that are already in the federal supply system specified?
3. Are adequate lubrication instructions (lubrication orders) provided that identify the frequency and type of lubricants required?
4. Are filler areas for combustible materials located away from sources of heat or sparking, and are spark-resistant filler caps and nozzles used on such equipment?
5. Are fluid-replenishing points located so there is little chance of spillage during servicing, especially on easily damaged equipment?
6. Are filler openings located where they are readily accessible and do not require special filling adapters or work stands?
7. Are air reservoir safety valves easily accessible and located where pop-off action will not injure personnel?
8. Are fuel tank filler necks, brake air cocks, flexible lines or cables, pipe runs, fragile components, and like items positioned so they are not likely to be used as convenient footholds or handholds, thereby sustaining damage?
9. If bleeds are required to remove entrapped air or gases from a fluid system, are they located in an easily operable and accessible position? Are bleed valves labeled with the proper operating instructions?
10. Are drains provided on all fluid tanks and systems, fluid-filled cases or pans, filter systems, float chambers, and other items designed to or likely to contain fluid that would otherwise be difficult to remove?
11. Are drain fittings of few types and sizes used, and are they standardized according to application throughout the system?
12. Are valves or petcocks used in preference to drain plugs? Where drain plugs are used, do they require only common hand tools for operation, and does the design insure adequate tool and work clearance for operation?
13. Are drain cocks or valves clearly labeled to indicate open and closed positions and the direction of movement required to open them?
14. Do drain cocks always close with clockwise motion and open with counterclockwise motion?
15. When drain cocks are closed, is the handle designed to be in the down position?
16. Are drain points placed so that fluid will not drain on the technician or on sensitive equipment?
17. Are drain points located at the lowest point when complete drainage is required or when separation of fluids is desired (as when water is drained out of fuel tanks)?
18. Are drain points located to permit fluid drainage directly into a waste container without use of adapters or piping?
19. Are drain points placed where they are readily operable by the technician?
20. Are instruction plates provided as necessary to insure that the system is properly prepared prior to draining?

(cont'd on next page)

**TABLE 8-4 (cont'd)**

21. Are drain points located so that fuel or other combustible fluids cannot run down to or collect in starters, exhausts, or other hazardous areas?
22. Are lubrication requirements reduced to two types, if possible, one for engine lubrication and one for gear lubrication?
23. Are the same fuels and lubricants used in auxiliary or mounted equipment as in the prime unit where practical? Are the fuels and lubricants used common with other commodities that would be assigned to the same combat units (tanks, trucks, ground power units, etc.)?
24. Are easily distinguished or different types of fittings used for points or systems requiring different or incompatible lubricants?
25. Are pressure fittings provided for the application of grease to bearings that are shielded from oil?
26. Is ample grease reservoir space provided for bearings in gear unit?
27. Is provision made for a central lubrication or filler point, or a minimum number of points, to all areas requiring lubrication with a given system component?
28. Are service points provided, as necessary, to insure adequate adjustment, lubrication, filling, changing, charging, and other services to all points requiring such servicing?
29. Are oil filler caps designed so that they
  - a. Snap, then remain open or closed?
  - b. Provide a large, round opening for oil filling?
  - c. Permit application of breather vents, dipsticks, and strainers?
  - d. Use hinges rather than dangerous chains for attaching the lid?
  - e. Are located outside of enclosure, where possible, to eliminate necessity for access doors, plates or hatches?
30. Are materials properly protected against moisture, fungus, and corrosion for storage and use?
31. Are items designed to be compatible with the standard military cleaning methods and materials?
32. Are parts subject to galvanic action properly separated and protected?
33. Are components subject to steam or solvent cleaning (or random contact during equipment cleaning) properly sealed to prevent interior damage?
34. Are mechanisms subject to wear and mechanical damage in use equipped with adjustments for aligning and repositioning?
35. Are filler locations for tanks and reservoirs labeled to indicate the type of fluid and maximum quantity?
36. Are preventive inspection and maintenance procedures based on detailed evaluation of actual preventive maintenance requirements for safety and reliability?
37. Does the equipment provide for adjustment and alignment without disassembly?
38. Does alignment or adjustment require no special tools or equipment?
39. Are alignment and adjustment controls located to permit observation or associated displays?
40. Are adjustments for all controls for a mechanism in a single location, e.g., engine controls?
41. Are control cable breakpoints separated sufficiently to assure that they will not be disconnected, which results in crossed controls? Are adjustment turnbuckles separated by sufficient distance to prevent interference within the range of full travel?
42. Will equipment tolerate a small maladjustment of controls for a reasonable period of test operation (5 rein) during the adjustment period without sustaining damage?
43. Are lubrication charts adequate?
44. Are group inspection features that are applicable to a particular technical skill held to a minimum of locations to minimize the need for technicians moving around the equipment and personnel interference during scheduled inspections?

## REFERENCES

1. *Airline Manufacturer's Maintenance Program and Planning Document MSG-2*, Air Transport Association of America, March 1970.
2. *Program Objective Memorandum*. (POM) 78-82.
3. DA PAM 750-40, *Guide to Reliability Centered Maintenance (RCM) for Fielded Equipment*, 15 February, 1980.
4. AMC-P 750-2, *Maintenance Supply and Equipment Guide to Reliability Centered Maintenance*, 14 June 1985.
5. DOD Directive 4/51.16, *DoD Equipment Maintenance Program*, 23 August 1984.
6. AR 750-1, *Army Materiel Maintenance Concepts and Policies*, 15 March 1983.
7. AR 700-127, *Integrated Logistics Support*, 16 December 1986.
8. MIL-STD-1388/1A, *Logistic Support Analysis*, 11 April 1983.
9. MIL-STD-1388/2A, *A Logistical Support Analysis Record, DoD Requirements for*, 20 July 1984.
10. DOD Directive 5000-40, *Reliability and Maintainability*, February 1982.
11. DARCOM Regulation 750-11, *Maintenance and Supplies—Use of Lubricants, Fluids, and Associated Products*, 20 November 1981.
12. MIL-STD-838, *Lubrication of Military Equipment*, December 1983.
13. MIL-F-3541, *Fitting, Lubrication*, January 1982.
14. MIL-STD-454, *Standard General Requirements for Electronic Equipment*, January 1983.
15. MS-35844, *Plug, Machine Thread, Magnetic (Drain)*, February 1978.
16. AR 750-22, *Army Oil Analysis Program*, April 1977.
17. TB 43-0210, *Nonaeronautical Equipment Army Oil Analysis Program (AOAP)*, December 1984.
18. TB 43-0106, *Army Aeronautical Equipment Army Oil Analysis Program (AOAP)*, April 1981.
19. MS-17967, *Nozzle Assembly Ventilation and Exhaust*, April 1965.
20. MIL-C-13984, *Can, Water, Military 5-gallon*, October 1981.
21. Federal Standard 595, *Color*, February 1980.
22. MIL-HDBK-772, *Military Packaging Engineering*, 30 March 1981.
23. MIL-STD-210, *Climatic Extremes for Military Equipment*, December 1973.
24. MIL-S-5002, *Surface Treatments and Inorganic Coatings for Metal Surfaces of Weapon Systems*, August 1978.
25. MIL-E-5400, *Electronic Equipment, Airborne, General Specifications For*, September 1980.
26. C. P. Dillon, Ed., *Forms of Corrosion, Recognition and Prevention*, National Association of Corrosion Engineers, Houston, TX, 1982, pp. 1 and 2.
27. M. G. Fontana and N. D. Greene, *Corrosion Engineering*, 2nd Ed., McGraw-Hill Book Company, New York, NY, 1978.
28. MIL-HDBK-721(MR), *Corrosion and Corrosion Protection of Metals*, November 1965.
29. B. Chalmers, *Physical Metallurgy*, John Wiley and Sons, Inc., New York, NY, 1959, p. 445.

**This page intentionally left blank.**

## CHAPTER 9

# HUMAN FACTORS

*The concept of human factors and the relationship between human factors and maintainability are discussed. This includes consideration of body measurements in designing for maintainability, with a goal of designing equipment for use by at least 90% of the user population (male and female). The major human senses and the relationship of each to maintainability design are also presented, as is the need to consider the psychology, motivation, and training of personnel. Other topics included are human error, stress, and strength.*

### 9-1 INTRODUCTION

In order for equipment to be used most efficiently, it must be designed for the specific user population. This constraint upon design is obviously, although perhaps unconsciously, one of the designer's primary considerations. Designers must design for personnel who, in tactical situations, will be under conditions of stress and fatigue from many causes. A performance decrement may arise in the tactical situation not so much because troops are basically unable to perform but because the individual soldier is overloaded both physically and mentally. Accordingly, equipment must be designed so that the procedures for using and maintaining it are as simple as possible. Equipment should not require intellectual tasks that will detract from the user's primary mission. Machines work well only if the personnel operating them perform their tasks satisfactorily. Therefore, the system engineering concept must be one of a person/machine system, i.e., a system in which operator and machine interact efficiently to perform a function. Training can improve operator or crew proficiency; however, training should not be considered a substitute for good design.

Human factors engineering is the science of applying technical knowledge to the design of equipment to achieve effective person machine integration, operation, and ease of maintenance. Human factors also are an essential element of the Manpower and Personnel Integration (MANPRINT) program, whose purpose is to impose human factors, manpower, personnel, training, system safety, and health hazard assessment considerations across the entire materiel acquisition process. The saying, "People are our most important resource", has been uttered many times. "The application of human factors engineering offers the prospect of moving beyond rhetoric and into action.

The human factors engineer relates human factors such as size, strength, and human sensory perceptions to the task to be accomplished. Failure to consider these factors results in increased problems of operability and maintainability. To avoid these problems, human factors engineers consider complex military systems as person/machine systems, including the capabilities and limitations of personnel under various conditions. Specifically, human factors engineering is concerned with

1. Persons, their characteristics—biomedical and psychological and their capabilities

2. Persons and their environment
3. Persons as an integral component of the system
4. Person/machine interfaces.

Because maintenance economy and efficiency are significantly affected by how well the human factors engineering function is implemented, the human factors engineer is responsible for insuring that an optimum interface exists between human capabilities and materiel design features. Each of the AMC commands have human factors engineers—representatives of the Human Engineering Laboratory—assigned to assist them in this important area.

Important sources of information to guide the maintainability engineer in assuring that human factors engineering is integrated into the design process follow:

1. *MIL-H-468S5 (Ref. 1)*. Establishes human engineering principles and procedures for acquiring and developing military systems and equipment. This military specification integrates personnel into the design and provides the Army with management control of the contractor's effort. For major acquisition programs this is usually accomplished with a Human Engineering Program Plan.

2. *MIL-STD-1472 (Ref. 2)*. Applicable to the design of all military systems and equipment. Ref. 2 includes human engineering design requirements for maintainability, labeling, work space design, and displays; and human engineering criteria, principles, and practices necessary to achieve mission success through the integration of the human into the system and to achieve effectiveness, simplicity, reliability, and safety of operation.

3. *MIL-HDBK-759 (Ref. 3)*. Establishes, in handbook form, general data and detailed criteria for human factors engineering application in the design and development of Army materiel for ease of maintenance. Areas covered in Ref. 3 of particular interest are

- a. Anthropometric data for men and women
- b. Features relating to military hardware—e.g., ammunition, missiles, tank gun control systems, and optical instruments
- c. Effects of environmental factors on human performance
- d. Physical limitations of the human body—strength and movement
- e. Illumination requirements.

Anthropometric data, body strength and movement

## DOD-HDBK-791(AM)

limitations, human sensory capabilities, environmental factors as they affect the soldier/ machine interface, psychological factors, and human error quantification are addressed in the paragraphs that follow. The information and data contained in MIL-HDBK-759 (Ref. 3) are not repeated in detail in this handbook; MIL-HDBK-759 will be referenced, and examples of the types of data will be presented. The reader is encouraged to refer to MIL-HDBK-759 for detailed data and criteria for human factors engineering applications.

### 9-2 ANTHROPOMETRY (BODY MEASUREMENTS)

Anthropometry—the study of human body measurements—is an important consideration in designing for maintainability because this information is necessary to design equipment that will accommodate operators and maintenance personnel of various sizes and shapes. The measurements relate to body dimensions together with the range of motion of body members and muscle strength. The data usually are presented in terms of upper and lower percentiles. The designer should always strive to accommodate the full range of personnel designated in MIL-STD-1472 (Ref. 2), i.e., 5th through 95th percentile male and female. When this does not appear to be feasible, the procuring activity must be notified. The reverse, designing work space and then adding the person, is usually inefficient and costly.

#### 9-2.1 SOURCES OF INFORMATION

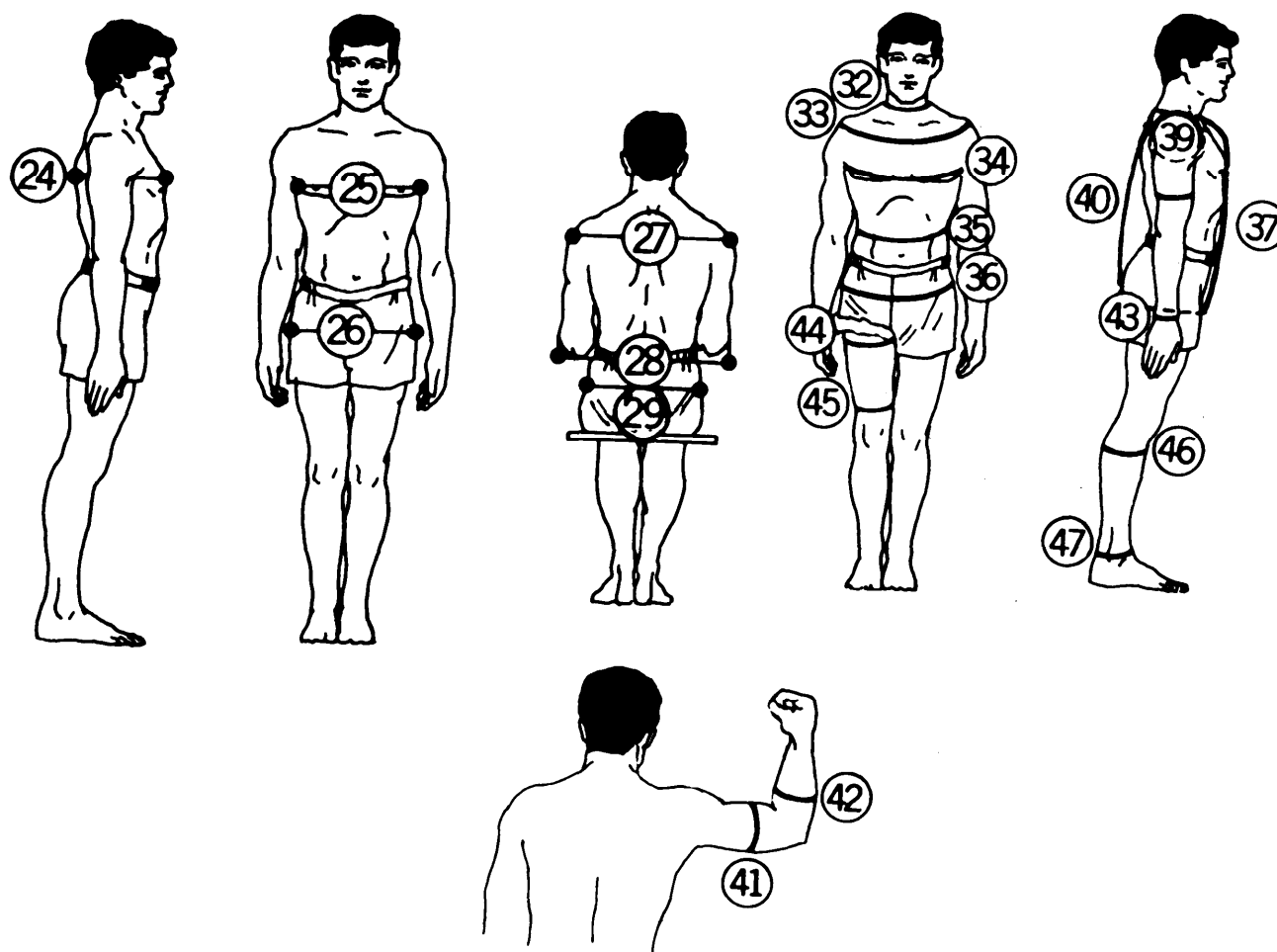
Section 5.6 of MIL-STD-1472 (Ref. 2) and par. 2.2 of MIL-HDBK-759 (Ref. 3) are devoted to anthropometric data together with illustrations to explain the data. An example of the type of data contained in Ref. 3 is shown in Fig. 9-1. (Similar data are presented for women.) Additional anthropometric data are contained in Refs. 4 through 11. Table 9-1 provides a list of laboratories that specialize in anthropometric research and a list of repositories of anthropometric data.

#### 9-2.2 MEASUREMENTS

Design and sizing measurements must insure accommodation, compatibility, operability, and maintainability by at least 90% of the user population (Ref. 3). Generally, design limits should be based upon a range from the 5th to the 95th percentile values for critical body dimensions. For any dimension, the 5th percentile value indicates that 5% of the population will be equal to or smaller than that value and 95% will be larger. Conversely, the 95th percentile value indicates that 95% of the population will be equal to or smaller than that value and 5% will be larger. Therefore, the use of a design range from the 5th to the 95th percentile values will theoretically accommodate 90% of the required user population for that dimension. It should be noted that designing to accommodate the 5th female through the 95th percentile male accommodates 90% of the combined populations (male and female) regardless of the male and female mix. This results

**TABLE 9-1. SOURCES OF ANTHROPOMETRIC DATA**

Name	Location
A. Primary: laboratories of anthropometry (which specialize in anthropometric research as well as gather a library of data)	
Aerospace Medical Research Laboratory, Wright-Patterson Air Force Base	Dayton, OH
US Army Natick Laboratories	Natick, MA
Anthropology project. Webb Associates	Yellow Springs, OH
Department of Human Anatomy, University of Newcastle	Newcastle-on-Tyne, England
Centre d'Anthropologie Appliquee, University de Paris	Paris, France
Department of Anthropology, Harvard University	Cambridge, MA
School of Public Health, Harvard University	Boston, MA
B. Secondary: repositories where anthropometric data may be found (where actual anthropometric services may or may not be obtainable)	
US Naval Training Devices Center	Orlando, FL
Aerospace Crew Equipment Laboratory, Naval Air Engineering Center	Philadelphia, PA
Human Engineering Laboratory	Aberdeen Proving Ground, MD
Guggenheim Center for Aviation and Safety, Harvard University	Boston, MA
Institute for Psychological Research, Tufts University	Medford, MA
Biotechnology Laboratory, University of California. Los Angeles	Los Angeles, CA
Furniture Institute Research Association	Stevenage, Hertfordshire, England
Unit for Research for Human Performance in Industry, Welsh College of Advanced Technology	Cardiff, Wales
Department of Ergonomics and Cybernetics, Loughborough College of Technology	Leicestershire, England
Institute of Engineering Production, University of Birmingham	Birmingham, England
Bureau International du Travail	Geneva, Switzerland



No.	Measurements	Percentiles											Range (1st-99th)
		1st	2nd	5th	10th	25th	50th	75th	90th	95th	98th	99th	
<b>BREADTH MEASUREMENTS, cm</b>													
24	Chest Depth	18.9	19.3	19.9	20.5	21.4	22.6	23.9	25.2	26.1	27.1	27.9	9.0
25	Chest Breadth	26.0	26.5	27.2	27.8	29.0	30.3	31.8	33.2	34.1	35.3	36.1	10.1
26	Hip Breadth, Standing	29.0	29.4	30.0	30.6	31.7	32.9	34.3	35.6	36.5	37.6	38.4	9.4
27	Shoulder Breadth	39.6	40.3	41.2	42.0	43.4	45.0	46.7	48.3	49.4	50.5	51.2	11.6
28	Forearm-Forearm Breadth	37.3	38.1	39.2	40.3	42.2	44.8	47.8	50.7	52.6	54.6	55.8	18.5
29	Hip Breadth, Sitting	29.2	29.7	30.4	31.1	32.2	33.7	35.4	37.1	38.2	39.4	40.1	10.9
<b>CIRCUMFERENCES, cm</b>													
32	Neck Circumference	32.6	33.2	34.0	34.6	35.7	37.0	38.4	39.8	40.6	41.5	42.1	9.5
33	Shoulder Circumference	98.9	100.4	102.5	104.4	107.8	111.9	116.5	120.8	123.5	126.6	128.7	29.8
34	Chest Circumference	80.0	81.3	83.2	85.0	88.2	92.2	96.7	101.4	104.5	108.2	110.8	30.8
35	Waist Circumference	65.5	67.3	69.4	70.9	73.7	78.0	84.2	91.0	95.5	100.5	103.6	38.1
36	Hip Circumference	81.0	82.4	84.3	85.9	88.9	92.7	97.4	102.2	105.2	108.7	110.9	29.9
37	Vertical Trunk Circumference	145.0	147.4	151.0	154.0	159.0	164.5	170.1	175.5	179.0	183.1	186.2	41.2
39	Armscye Circumference	38.0	38.7	39.7	40.6	42.2	44.2	46.3	48.5	49.9	51.6	52.8	14.8
40	Biceps Circumference Relaxed	23.4	24.0	24.9	25.6	27.0	28.8	30.8	32.8	34.0	35.2	36.0	12.6
41	Biceps Circumference Flexed	26.1	26.7	27.6	28.4	29.9	31.7	33.6	35.5	36.6	38.0	38.8	12.7
42	Forearm Circumference Flexed	24.8	25.3	26.0	26.6	27.8	29.1	30.6	31.9	32.7	33.6	34.2	9.4
43	Wrist Circumference	11.3	11.6	12.4	13.2	14.6	16.0	17.1	18.0	18.6	19.5	20.2	8.9
44	Upper Thigh Circumference	44.8	45.8	47.2	48.6	51.0	54.1	57.8	61.3	63.4	65.7	67.0	22.2
45	Lower Thigh Circumference	32.0	32.8	33.9	34.8	36.6	39.0	41.8	44.6	46.3	48.1	49.2	17.2
46	Calf Circumference	30.4	31.1	32.0	32.9	34.3	36.1	38.0	39.9	41.1	42.4	43.2	12.8
47	Ankle Circumference	19.7	20.0	20.5	20.9	21.7	22.6	23.6	24.6	25.2	25.9	26.4	6.7

Figure 9-1. US Army Basic Trainees (1966): Breadth & Circumference Measurements (Ref. 3)

## DOD-HDBK-791(AM)

because the male and female anthropometric dimensions overlap so that all males equal to or below the 95th percentile and all females equal to or above the 5th percentile are accommodated.

Some of the measurements important to maintainability (Ref. 12) are

1. Basic body dimensions:
  - a. Stature
  - b. Eye height
  - c. Shoulder height
  - d. Arm reach
  - e. Elbow-hand length
  - f. Knee height and leg length
  - g. Hand size
  - h. Body breadth
2. Body mobility
3. Dexterity
4. Field of vision.

Anthropometric data are usually given as nude body dimensions; however, MIL-STD-1472 (Ref. 2) and MIL-HDBK-759 (Ref. 3) provide data that take into account arctic clothing, which usually is the worst case from the standpoint of maintenance accessibility. Nuclear, biological, and chemical (NBC) protective garments are also a problem because they produce heat stress, reduced vision, reduced tactile sense, and increased breathing effort. Fig. 4-15 shows the increased dimensions for a gloved hand. Figs. 4-13 and 4-14 and Table 4-2 illustrate application of anthropometric data to facilitate maintenance operations.

In the application of anthropometric data, both static and dynamic body measurements must be addressed. Static measurements range from the gross aspects of body size, such as stature, to the distance between the pupils of the eyes and are measured with the subject in rigid, standardized positions. Dynamic body measurements, on the other hand, usually vary with body movement and relate more to human performance than to human "fit" (Ref. 1). Par. 2.3.1 of MIL-HDBK-759 (Ref. 3) gives the ranges for all voluntary movements the joints of the body can make.

In summary, the following should be considered when interpreting and applying anthropometric data:

1. Nature, frequency, and difficulty of related tasks
2. Position of body during performance of tasks
3. Mobility or flexibility requirements imposed by tasks
4. Increments in the design-critical dimensions imposed by protective garments, packages, lines, padding, etc.

### 9-3 HUMAN STRENGTH AND HANDLING CAPACITY

Equipment that is designed to be consistent with a person's capabilities permits more force to be exerted with less fatigue. However, if the demands placed on human strength are too high, inefficient and unsafe performance will result. Conversely, if the designer underestimates strength, unnecessary design effort and expense may be incurred. The proper strength value to use in designing equipment is the maximum force that can be

exerted by a 5th percentile member of the user population.

The maximum force that can be applied by a person depends on many factors such as the position of the body, the body member(s) applying the force, the direction of application, the object to which the force is applied, and whether or not support is provided. The following conclusions regarding the application of force should be of value to the designer (Ref. 12):

1. The greatest force is developed in pulling toward the body. An individual using his leg and back muscles can exert a stronger pulling force than a seated individual.

2. The maximum force that can be exerted increases with the use of the whole arm and shoulder, but use of the fingers alone requires the least energy per unit of force applied.

3. Push exerts a greater force than pull in side-to-side motion.

Fig. 9-2 (Ref. 3) shows the arm, hand, and finger strength of 95% of male personnel for various directions of movement and body members.

Whenever possible, equipment parts should be designed so that one person can lift them. If this is not possible, the parts should be clearly labeled with weight and lift limitations. Table 9-2 (Ref. 3) shows the lifting capacity of 95% of male users. These weight limits should be reduced when difficult conditions exist, such as

1. When the object is very difficult to handle i.e., bulky, slippery, etc.
2. When access and work space conditions are less than optimal
3. When the required force must be exerted continuously for more than 1 min
4. When the object must be positioned exactly or handled delicately
5. When the task must be repeated frequently.

Par. 2.4.2 of MIL-HDBK-759 (Ref. 3) provided additional figures and tables for determining human strengths and handling capacities.

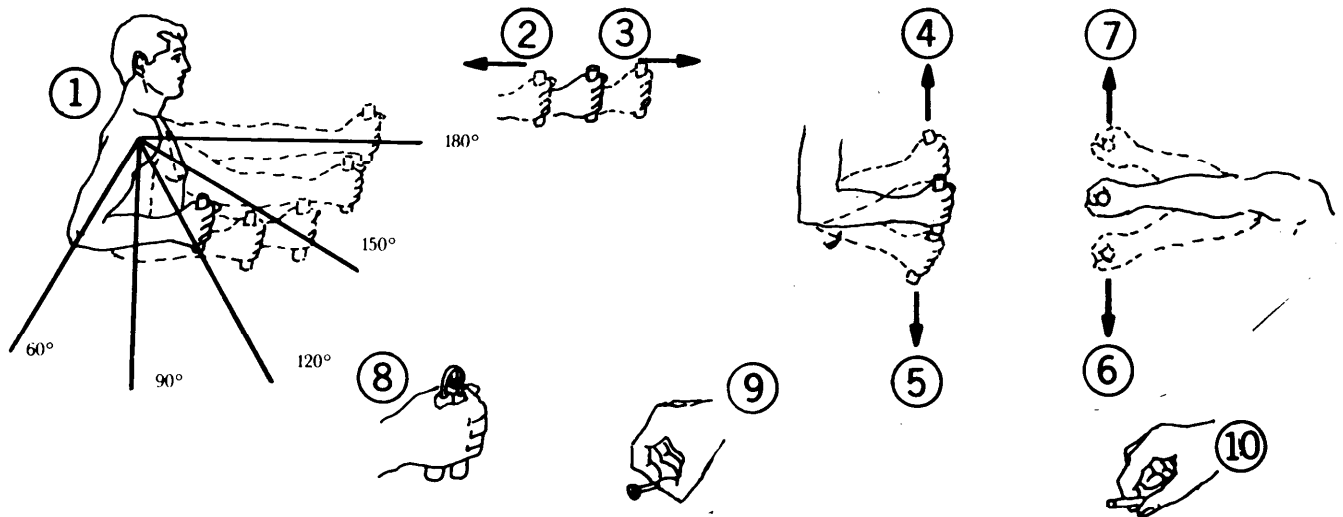
### 9-4 HUMAN SENSORY CAPABILITIES

Individuals, as part of a total system, possess many useful sensors. Of the five major senses—sight, hearing, taste, smell, and touch—only sight, hearing, and touch will be addressed since they are the major factors affecting maintainability engineering.

#### 9-4.1 SIGHT

It is estimated that humans acquire 80% of their knowledge visually (Ref. 7). Thus the maintenance technician's sight capabilities are important to the maintainability engineer. The typical maintenance technician

1. Can distinguish 10 colors, five sizes of figure, five brightnesses of light, and two flicker rates
2. Can easily read 6-point type with adequate lighting
3. Has a visual field of about 130 deg vertically and 208 deg horizontally with maximum acuity at the center
4. Requires about 0.6 s to change visual fixation from near to far
5. Takes about 30 min to adapt completely from daylight to darkness



**Arm Strength for Sitting Man**

① Elbow Flexion, deg	② Pull,				③ Push,				④ Up,			
	N	R* lb	N	L* lb	N	R lb	N	L lb	N	R lb	N	L lb
180	231	52	222	50	222	50	187	42	62	14	40	9
150	249	56	187	42	187	42	133	30	80	18	67	15
120	187	42	151	34	160	36	116	26	107	24	76	17
90	165	37	142	32	160	36	98	22	89	20	76	17
60	107	24	116	26	151	34	98	22	89	20	67	15

① Elbow Flexion, deg	⑤ Down,				⑥ In,				⑦ Out,			
	N	R* lb	N	L* lb	N	R lb	N	L lb	N	R lb	N	L lb
180	76	17	58	13	89	20	58	13	62	14	36	8
150	89	20	80	18	89	20	67	15	67	15	36	8
120	116	26	93	21	98	22	89	20	67	15	45	10
90	116	26	93	21	80	18	71	16	71	16	45	10
60	89	20	80	18	89	20	76	17	76	17	53	12

\*L = left  
R = right

**Hand and Thumb-Finger Strength**

Holding Time	⑧ Hand Grip,				⑨ Thumb-Finger Grip (Palmar),		⑩ Thumb-Finger Grip (Tips)	
	N	R lb	N	L lb	N	lb	N	lb
Momentary Hold	260	59	250	56	60	13	60	13
Sustained Hold	155	35	145	33	35	8	35	8

**Figure 9-2. Arm, Hand, and Thumb-Finger Strength (5th Percentile Man) (Ref. 3)**

TABLE 9-2. MAXIMUM WEIGHT LIMITS (Ref. 3)

Type of Handling	Height Lifted									
	m	ft	m	ft	m	ft	m	ft	m	ft
	0.3	1	0.6	2	0.9	3	1.2	4	1.5	5
Lifting, kg (lb) <sub>m</sub> <sup>1,3</sup>										
One person	38.6	(85)	36.3	(80)	29.5	(65)	22.7	(50)	15.9	(35)
Two persons	77.1	(170)	72.6	(160)	59.0	(130)	45.4	(100)	31.8	(70)
Carrying (five steps or less), kg (lb) <sub>m</sub> <sup>2</sup>										
One person	29.5	(65)								
Two persons	59.0	(130)								

<sup>1</sup>These weight limits should be used as maximum values in establishing the weights of items that must be lifted.

These limits apply to items up to 380 mm (15 in.) long and up to 305 mm (12 in.) high, with handles or grasp areas as shown in Fig. 4-20. These limits should not be used for larger items or for items which must be lifted repetitively.

<sup>2</sup>These weight limits should not be used if personnel must carry the item more than five steps.

<sup>3</sup>When an item weighs more than the limit for one-man lifting, it should be prominently labelled with weight and lift limitations, e.g., two-person or mechanical lift. Items to be lifted mechanically should have prominently labelled hoist and lift points.

6. Suffers discomfort and impaired vision if bright lights or reflections are located within 60 deg of his line of sight.

Sight is stimulated by radiation of certain wavelengths—430 to 690  $\mu\text{m}$  (4300 to 6900 A)—commonly called the visible portion of the electromagnetic spectrum. The maintenance technician can see all colors of the spectrum violet through red—while looking straight ahead. However, color perception decreases as the viewing angle increases. Consequently, if the equipment has color-banded meters or warning lights of different colors that are near the maximum viewing angle limits, the maintenance technician may not be able to distinguish one color from another. The color of the illuminating light source is also an important factor when viewing color-coded objects. At night, or in any poorly illuminated area, color makes little difference. Similarly, if the source is distant or small—such as a small warning light—blue, green, yellow, and orange are indistinguishable; they all appear to be white. Another phenomenon of color perception is apparent reversal of color. When an individual stares at a red or green light, for instance, and then glances away, the signal to the brain may reverse the color. This phenomenon has caused many accidents. Therefore, color should not be relied upon solely when critical operations may be performed by fatigued personnel or under circumstances where color perception may not be good. In addition to problems regarding color perception, maintainability design is concerned with insuring that visual displays are placed properly for effective use. Fig. 9-3 provides design guidance for the horizontal and vertical visual fields.

A technician needs sufficient light to perform tasks properly; accuracy, speed, and safety suffer if he cannot

see well. Adequate illumination, however, will not always be available. Accordingly, equipment designers should endeavor to develop their designs to permit effective maintenance under even the poorest anticipated lighting conditions. To this end, designers should acquaint themselves with all of the possible circumstances that may reduce available illumination. For example, if a flashlight is necessary to illuminate the area to be accessed, the equipment should be designed so that maintenance can be performed by the light of a flashlight. This assumes that the person performing the maintenance has a free hand to hold the flashlight and that there is space available to stand while holding the flashlight.

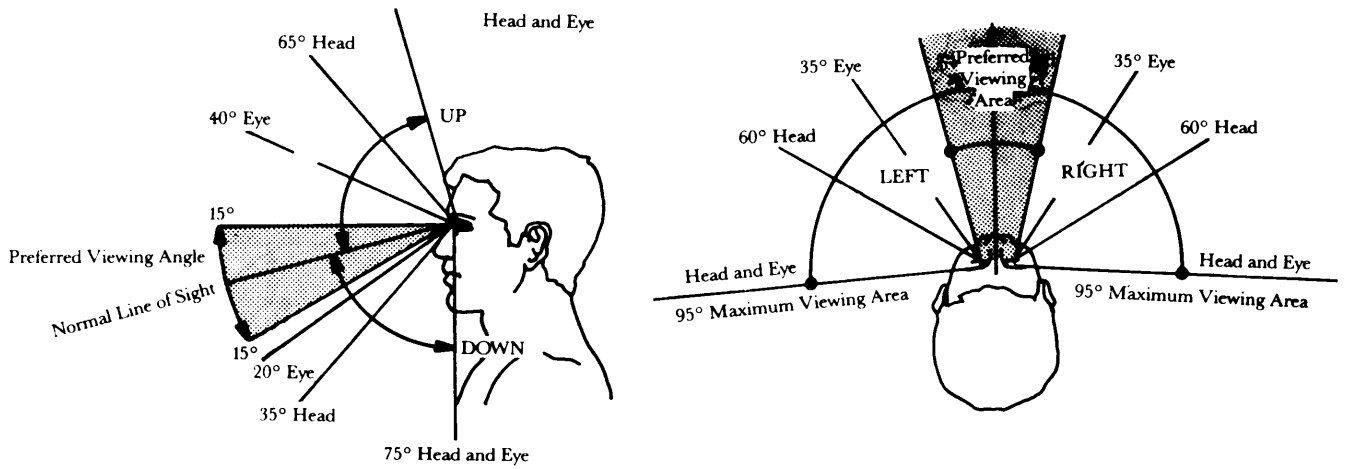
Basic factors that should be considered in the design of lighting systems are

1. Suitable brightness for the task at hand
2. Uniform lighting
3. Suitable brightness contrast between task and background

4. Lack of glare from light source or work surface. It is difficult to specify exact illumination levels for designing an efficient lighting system, but guidelines are shown in Tables 9-3 and 9-4 (Ref. 3). The examples of illumination levels expressed in Table 9-3 are presented so the designer may estimate the illumination levels for these tasks within the system that are not directly related to the tasks of Table 9-4.

The ability of personnel to see cathode-ray tube signals, such as those on oscilloscopes, depends on five main visual factors (Ref. 3), namely.

1. Size, in visual angle, of the signal
2. Brightness of the background (The ambient illuminance should not contribute more than 25% of the screen brightness.)



	Preferred, deg	Maximum*		
		Eye Rotation Only, deg	Head Rotation, deg	Head and Eye Rotation, deg
UP	15	40	65	90
DOWN	15	20	35	85
RIGHT	15	35	60	95
LEFT	15	35	60	95

\*Display area on the console defined by the angles measured from the normal line of sight.

Figure 9-3. Visual Field (Ref. 3)

TABLE 9-3. ILLUMINATION REQUIREMENT FOR REPRESENTATIVE TASKS (Ref. 3)

Task	Illumination Levels				Light Source
	Recommended		Minimum		
	lux	fc	lux	fc	
Perceiving small details with low contrast for prolonged times, or where speed and accuracy are essential (examples: repairing small components, inspecting dark materials, layout drafting)	1615	150	1075	100	General Services plus supplementary
Perceiving small details with fair contrast where speed and accuracy are not so essential (examples: handwriting, electronic assembly)	1075	100	540	50	General Services and/or supplementary
Prolonged reading, desk or bench work, general office and laboratory work (examples: assembly work, filing records)	755	70	540	50	General Services and/or supplementary
Occasional reading, recreation, reading signs where visual tasks are not prolonged (example: reading a bulletin board)	540	50	325	30	General Services and/or supplementary
Perceiving large objects with good contrast (example: locating objects in bulk supply warehouse)	215	20	110	10	General Services
Passing through walkways, handling large objects (example: loading from a platform)	215	20	110	10	General Services

TABLE 9-4. SPECIFIC TASK ILLUMINATION REQUIREMENTS (Ref. 3)

Work Area or Type of Task	Illumination Levels*			
	Recommended		Minimum	
	lux	fc	lux	fc
Assembly, missile component	1075	100	540	50
Assembly, general				
coarse	540	50	325	30
medium	810	75	540	50
fine	1075	100	810	75
precise	3230	300	2155	200
Bench work				
rough	540	50	325	30
medium	810	75	540	50
fine	1615	150	1075	100
extra fine	3230	300	2155	200
Business machine operation (calculator, digital, input, etc.)	1075	100	540	50
Console surface	540	50	325	30
Corridors	215	20	110	10
Circuit diagram	1075	100	540	50
Dials	540	50	325	30
Electrical equipment testing	540	50	325	30
Emergency lighting			32	3
Gages	540	50	325	30
Hallways	215	20	110	10
Inspection tasks, general				
rough	540	50	325	30
medium	1075	100	540	50
fine	2155	200	1075	100
extra fine	3230	300	2155	200
Machine operation, automatic	540	50	325	30
Meters	540	50	325	30
Missiles				
repair and servicing	1075	100	540	50
storage areas	215	20	110	10
general inspection	540	50	325	30
Office work, general	755	70	540	50
Ordinary seeing tasks	540	50	325	30
Panels				
front	540	50	325	30
rear	325	30	110	10
Passageways	215	20	110	10

(cont'd on next page)

TABLE 9-4 (cont'd)

Work Area or Type of Task	Illumination Levels*			
	Recommended		Minimum	
	lux	fc	lux	fc
Reading				
large print	325	30	110	10
newsprint	540	50	325	30
handwritten report, in pencil	755	70	540	50
small type	755	70	540	50
prolonged reading	755	70	540	50
Recording	755	70	540	50
Repair work				
general	540	50	325	30
instrument	2155	200	1075	100
Scales	540	50	325	30
Screw fastening	540	50	325	30
Service areas, general	215	20	110	10
Storage				
inactive or dead	54	5	32	3
general warehouse	110	10	54	5
live, rough or bulk	110	10	54	5
live, medium	325	30	215	20
live, fine	540	50	325	30
Switchboards	540	50	325	30
Tanks, container	215	20	110	10
Testing				
rough	540	50	325	30
fine	1075	100	540	50
extra fine	2155	200	1075	100
Transcribing and tabulation	1075	100	540	50

\*As measured at the task object or 760 mm (30 in. ) above the floor

NOTE 1: Some unusual inspection tasks may require up to 10,800 lux ( 1000 fc)

NOTE 2: As a guide in determining illumination requirements, the use of a steel scale with 0.38-mm (0.01 -in.) divisions requires 1950 lux (180 fc) of light for optimum visibility.

NOTE 3: The brightness of transilluminated indicators should be compatible with the expected ambient illumination level and should be at least 10% greater than the surrounding brightness; however, the indicator brightness should not exceed 300% of the surrounding brightness.

## DOD-HDBK-791(AM)

3. Brightness of the signal
4. Length of time the signal is present
5. State of adaptation of the eye.

The level of luminance recommended for characters on a visual display terminal is 170 cd m<sup>2</sup> (50 fc) (Ref. 13).

### 9-4.2 HEARING

Hearing is an important sense in terms of information gathering. Sound waves reaching the ear vary in frequency, amplitude, and complexity. Sound is usually described in terms of its two major characteristics, i.e., frequency and intensity. Frequency is measured in cycles per second expressed as hertz (Hz). Generally, the human ear responds to frequencies between 20 and 20,000 Hz, though few adults hear near the 20,000-Hz limit. Frequencies above the 20,000-Hz limit cannot normally be heard by humans, but they do produce some biological effects.

The intensity of sound, or loudness, is usually measured in decibels (d B). Weighting networks consist of three alternate frequency response characteristics designated A-, B-, and C-weighting. Whenever one of these

networks is used, the reading obtained must be identified properly. For example, if an A-weighted sound pressure level of 90 is obtained, it would be reported as a 90-dB(A). The A-weighted network is particularly valuable if a quick estimate of the interference of noise upon speech is required (par. B.1.1.2.1.2. Ret. 3). Areas requiring occasional telephone use or occasional direct communication at distances up to 1.5 m (5 ft) should not exceed a 75-dB(A) level (par. 10-5.1. Ret. 13).

The intensity and source location of audio alarms and signals should be selected for compatibility with the acoustic environment of the intended receiver (Ref. 14). When discrimination of warning signals is critical to personnel safety or system performance, audio signals should be selected to signify different conditions requiring different operator responses i.e. one signal for maintenance, another for emergencies, etc. For the purpose of this handbook, auditory signals will be considered to be of three basic types i.e., tones, complex sounds, and speech. A comparison of the strengths and weaknesses of these types with respect to their use for various functions is presented in Table 9-5 (Ref. 3).

**TABLE 9-5. FUNCTIONAL EVALUATION OF AUDIO SIGNALS (Ref. 3)**

FUNCTION	TYPE OF SIGNAL		
	TONES (Periodic)	COMPLEX SOUNDS (Nonperiodic)	SPEECH
QUANTITATIVE INDICATION	POOR Maximum of 5 to 6 tones absolutely recognizable.	POOR Interpolation between signals inaccurate.	GOOD Minimum time and error in obtaining exact value in terms compatible with response.
QUALITATIVE INDICATION	POOR-TO-FAIR Difficult to judge approximate value and direction of deviation from null setting unless presented in close temporal sequence.	POOR Difficult to judge approximate deviation from desired value.	GOOD Information concerning displacement, direction, and rate presented in form compatible with required response.
STATUS INDICATION	GOOD Start and stop timing. Continuous information where rate of change of input is.	GOOD Especially suitable for irregularly occurring signals. e.g., alarm signals.	POOR Inefficient: more easily masked; problem of repeatability.
TRACKING	FAIR Null position easily monitored; problem of signal-response compatibility.	POOR Required qualitative indications difficult to provide.	GOOD Meaning intrinsic in signal.
GENERAL	Good for automatic communication of limited information. Meaning must be learned. Easily generated.	Some sounds available with common meaning, e.g., fire bell. Easily generated.	Most effective for rapid (but not automatic) communication of complex, multidimensional information. Meaning intrinsic in signal and context when standardized. Minimum of new learning required.

Occasionally in maintainability design, auditory signals are preferable to visual ones, and vice versa. Table 9-6 summarizes the situations in which one form is preferred over the other. However, when the maintenance technician must monitor several audio signals (channels) which must be recognizable above the sound of the equipment being tested or maintained, the signals should be of different frequencies—e.g., high, medium, and low—to avoid confusion.

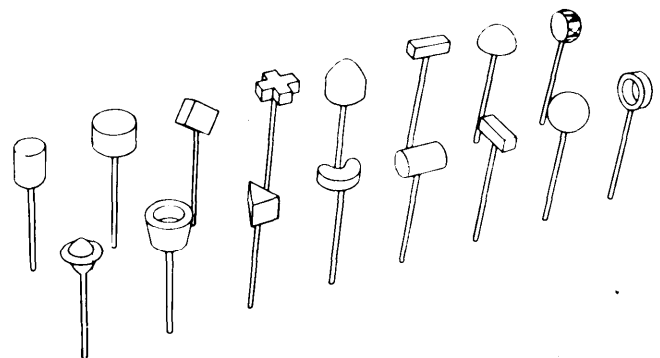
Noise is defined as any undesirable sound. Excessive noise in a maintenance or operations area reduces the efficiency of the personnel and thus may impair or reduce overall system effectiveness. Excessive noise also affects personnel psychologically; they fatigue more rapidly, their ability to concentrate decreases, and their annoyance increases. In addition to affecting the performance of maintenance technicians, excessive noise can render oral communications ineffectual or impossible. Fig. 9-4 (Ref. 2) shows the difficulty in communicating at various noise levels and speaker-to-listener distances.

Exposure to high noise levels can also produce physiological effects—exposure to noise levels exceeding 85 dB may result in a temporary or permanent hearing loss; the extent of damage depends on the length of the exposure. Table 9-7 lists the intensity of common sounds and their effect on exposed personnel. TB MED 501 (Ref. 15) defines the noise hazards and the hearing conservation program of the US Army. Appendix B of Ref. 3 presents a detailed discussion of hearing loss resulting from both steady state and impulse noise together with the factors influencing hearing loss and recovery; the resultant effects on performance are also discussed. Personnel in acoustic environments where the risk criteria are exceeded should be protected to avoid damage to their hearing. The most effective method of protection is to control the noise at its source. If noise control is not practical, personnel must be protected with ear protectors such as earmuffs or earplugs.

### 9-4.3 TOUCH

As equipment becomes more complex, it is necessary for maintenance workers to employ all their senses to the fullest. Man's ability to interpret visual and auditory stimuli is closely associated with the sense of touch. The sensory cues received by the skin and muscles can be used, to some degree, to convey messages to the brain, which relieves the eyes and ears of part of the load they would otherwise bear. For example, the control knob shapes illustrated in Fig. 9-5 (Ref. 3) can be recognized easily by touch alone. These knobs have been specifically designed and experimentally validated for tactile recognition (Ref. 3). Many of these knob shapes could be used when the maintenance technician must rely completely on his sense of touch, for example, when the user is busily looking elsewhere when that control must be moved.

It is an Army tradition that personnel must be able to field strip weapons based on touch alone. Therefore, it is incumbent upon weapon designers to make the shape and size of each part unique to facilitate field stripping.



**Figure. 9-5. Easily Recognizable Knob Shapes (Ref. 3)**

### TABLE 9-6. WHEN TO USE AUDITORY OR VISUAL FORM OF PRESENTATION

Use auditory presentation if

1. The message is simple.
2. The message is short.
3. The message will not be needed later.
4. The message deals with events in time.
5. The message calls for immediate action.
6. The visual system of the person is overburdened.
7. The receiving location is too bright or dark; adaptation integrity is necessary.
8. The person's job requires him to be moving continually.

Use visual presentation if

1. The message is complex.
2. The message is long.
3. The message will be needed later.
4. The message deals with location in space.
5. The message does not call for immediate action.
6. The auditory system of the person is overburdened.
7. The receiving location is too noisy.
8. The person's job allows him to remain in one position.

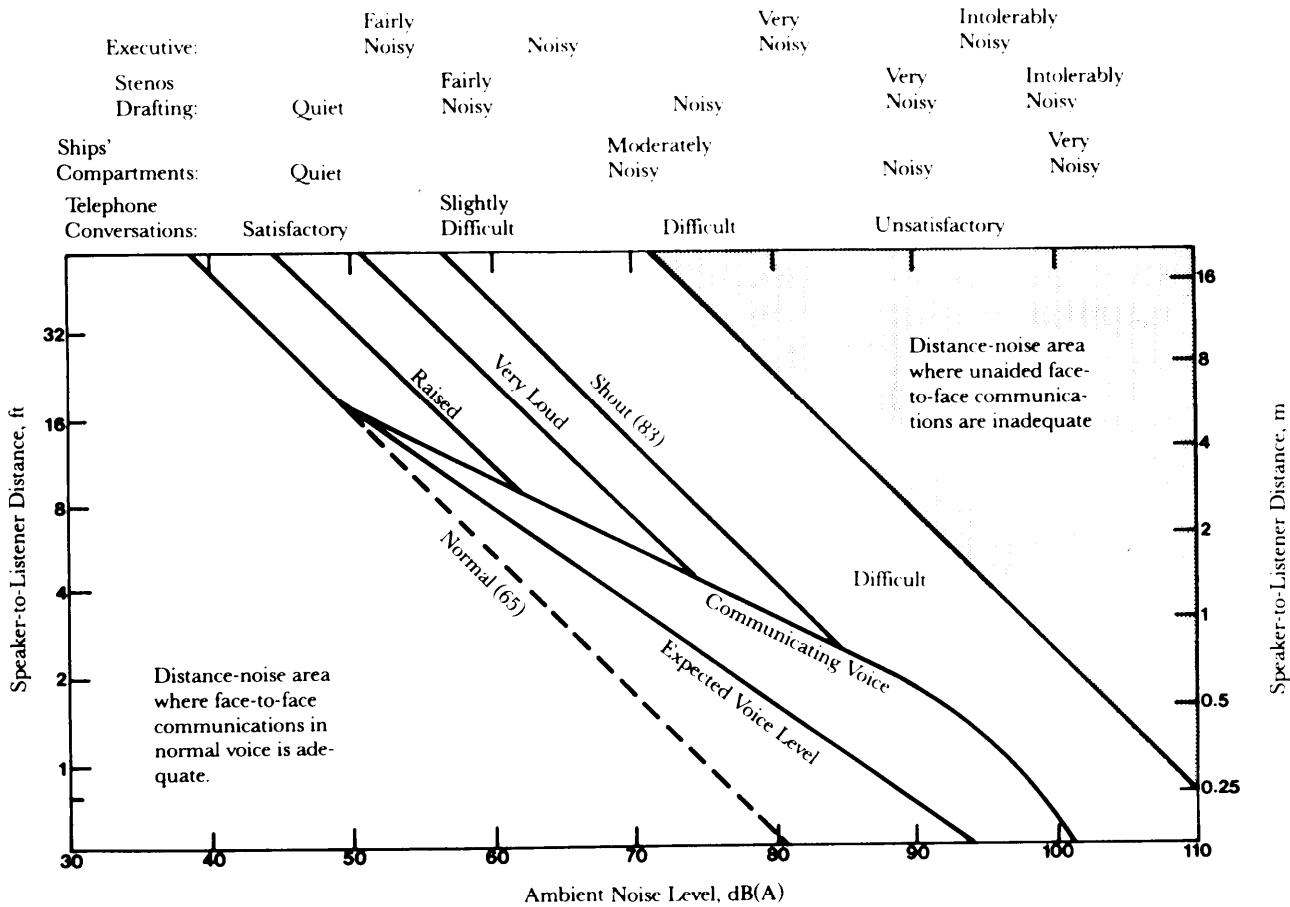


Figure 9-4. Permissible Distance Between Speaker and Listener for Specified Voice Levels and Ambient Noise Levels (The levels in parentheses refer to voice levels measured one meter from the mouth.) (Ref. 2)

TABLE 9-7. SOUND INTENSITY LEVELS

Effect on Personnel	Intensity Level, dB	Remarks
Levels unacceptable as dangerous to personnel	150	Maximum permissible (regardless of amount of attenuation in ear canal)
	130	Approximate threshold of pain
	120	Loud thunder
	110	Punch press
	100	
Reduction of efficiency may occur above this point	90	City bus
Acceptable noise level	80	
	70	Heavy traffic
	60	Normal conversation
	50	
	40	Quiet residential area
	30	
	20	Voice whisper
	10	Motion picture sound studio
	0	Approximate threshold of hearing

The sense of touch is greatly diminished by the protective gloves required when working in cold or contaminated environments or on cryogenic systems such as liquid oxygen. In these cases, it is inappropriate to rely on the sense of touch to the same degree as when a task is performed with bare hands.

## 9-5 PSYCHOLOGICAL FACTORS

Psychological factors include adaptability, aptitude, attitude, motivation, and behavior. Since all individuals have different physical attributes, experiences, abilities, intellect, and emotions, each person is psychologically unique. Accordingly, designers must keep in mind the lack of psychological uniformity among users and maintenance workers.

Although errors and inefficiencies introduced by psychological factors will inevitably occur, methods have been developed to minimize their frequency and severity. Work environments should be designed for the mental well-being of personnel, and the capabilities and normal reactions of personnel should be considered in the design process. Many of these design features are defined in MIL-STD-1472 (Ref. 2).

### 9-5.1 MOTIVATION AND TRAINING

People are motivated by numerous things esprit de corps, patriotism, love, hate, revenge, sex, competition, prestige, hunger, fear, pride of accomplishment, financial rewards, etc. In most cases, motivation is a positive factor because it creates a desire to accomplish a mission successfully. Some of the factors that can be controlled by the designer to enhance motivation include comfort, security, and safety. Lack of these factors will adversely affect motivation.

Motivational factors promoted by the Army that are important to the maintenance technicians are achievement, recognition of achievement, the nature of the work itself, responsibility, and growth or advancement. Army career planning provides for optimal personnel development by providing (1) opportunity for training and a progression of selected assignments, (2) counseling to assist in career goal setting, and (3) incentive recognition for accomplishments (Ref. 16).

Skill level is an indicator of capability, not of drive. Motivational training for the maintenance technician helps to maintain an adequate level of personnel competency. This is especially true of training designed to influence attitudes, as in safety training. Appeals to loyalty, interest in work, prestige, and other such factors will increase motivation.

### 9-5.2 CAPABILITY

The design engineer should consider the skills required and the personnel available to operate and maintain equipment. Equipment that requires skill levels higher than those available cannot be successfully maintained. Care must be exercised to insure that the equipment does not outstrip the abilities of the soldier.

It is difficult to obtain and retain skilled military main-

tenance personnel. Therefore, the equipment designer must build in maintenance features that would be unnecessary if highly skilled technicians were available.

As the complexity of the maintenance task increases, the time required to train maintenance specialists also increases. Maintenance actions—relying on modularization and the use of built-in test equipment—should, therefore, be as simple as possible to permit the shortest training time so that a technician's effective service after training can be proportionately increased.

In the design of Army equipment, the user skill level should be considered throughout the life cycle of the product. The optimal design goal should be equipment that can be repaired effectively by the least experienced personnel using pertinent manuals. For development purposes the "typical" Army technician should be assumed to possess the following characteristics (Ref. 17):

1. Average age: 22.2 yr
2. Average civilian education: 12 yr (90.8% are high school graduates)
3. Average reading comprehension: ninth grade (based on US Army Infantry School 1978 report.)
4. Average service education: 19 weeks, including basic training, specialty training, and weapon system training
5. Applicable civilian experience: minimum
6. Applicable Army experience: overall average is approximately 6.7 yr, but 50.3% of the technicians who will perform most of the work (nonsupervisory) will be in their first term of service.

Terms used to identify and establish specific tasks and skills follow:

1. *Military Occupational Specialty (MOS)*. This is a term used to identify a group of closely related duty positions. The skills required in each of these duty positions are similar. Therefore, an individual qualified to perform in one of these positions can, with adequate on-the-job training, perform satisfactorily in others of the same complexity or difficulty (Ref. 16). The MOS identifies type of skill rather than level of skill. For example, the MOS for infantrymen (11 B) encompasses all positions ranging from a rifleman to a battalion operations sergeant.

2. *Military Occupational Specialty Code (MOSC)*. This is a more specific operational identification. It not only defines the type of skill but also the level of skill, the level of proficiency, and the scope of responsibility.

3. *Career Management Fields (CMF)*. These are manageable groups of related MOSS. As an example, the CMF for Air Defense missile maintenance contains 28 MOSS. They are used in the selection of personnel for Air Defense units and in unit and intermediate support missile maintenance units. Qualifications for the Air Defense missile maintenance CMF include

a. *Educational*:

- (1) Basic mechanical, electrical, and mathematical abilities and interests
- (2) A high verbal ability for comprehension and communication of complex technical data
- (3) A high degree of reasoning ability for rapid

diagnosis of equipment malfunctions

b. *Physical Requirements.* Normal color vision, night vision, near vision, auditory acuity, hand-eye coordination, manual dexterity, and clarity of speech

c. *Occupational Qualifications.* Knowledge of the functioning, assembly, testing, and maintenance of a variety of mechanical, electronic, electrical, hydraulic, and pneumatic components of missile weapon systems. These systems include missile guidance, acquisition radar, target track radar, missile track radar, digital and analog computers, and fire distribution systems.

## **9-5.3 HUMAN ERROR**

### **9-5.3.1 General**

Human error can be defined as any personnel action that is inconsistent with behavioral patterns considered to be normal or any action that differs from prescribed procedures. Human error includes (Ref. 18)

1. Failing to perform a task (omission)
2. Incorrectly performing a task
3. Performing a task not required
4. Performing a task out of sequence
5. Failing to perform a task within the allocated time
6. Responding inadequately to a contingency.

Human errors always have been made and will continue to be made, as stated by the following variations of Murphy's Law ("Anything that can go wrong will go wrong.") (Ref. 18):

1. "Any task that can be done incorrectly, no matter how remote the possibility is, will someday be done incorrectly."
2. "No matter how difficult it is to damage equipment, a way will be found to do so."
3. "At some time, instructions will be ignored when the most complicated task is being performed."

The need to avoid human error increases with the size, complexity, and yield of the weapon system. The greater the size and complexity, the greater the number of maintenance tasks, and the more chances there are for human error. The larger the weapon system yield, the greater the accident potential in the event of a human error.

Complex equipment does not of necessity require greater skill to operate nor is it more difficult to service; complex equipment can be designed for simplicity of operation and maintenance. However, the more complex these actions are, the more vulnerable they are to human error—particularly when the user is under tension or emotional stress. This can be a critical problem in combat or emergency situations. An Army study (Ref. 19) subjected recruits to simulated emergencies, such as the increasing proximity of falling mortar projectiles to their command posts, in a manner that they believed the situations to be real. As many as one third of the new recruits fled in panic; they did not perform the assigned task that would have ended the mortar attack. These studies indicate the devastating effects that very high stress levels can have on the performance of even thoroughly trained, reliable personnel.

### **9-5.3.2 Causes**

Regardless of thorough training and high skill levels, a technician will make mistakes, and errors frequently cause equipment malfunction with varying consequences. For example, a driver fails to fill the radiator of a truck, the engine overheats, and the truck stops on the road inconvenient but not serious. A technician fails to put a cotter pin in a castellate nut in the flight control linkage of an aircraft, control of the plane is lost in flight, the plane crashes, and all aboard are killed very serious.

Maintenance requirements are so demanding that they often leave no room for human error, yet mistakes will be made. For example, a report by one of the military services revealed that in a 15-month period errors made in aircraft maintenance contributed to 475 accidents and incidents in flight and ground operations. Ninety-six aircraft were seriously damaged or destroyed, and 14 lives were lost (Ref. 14). A study of these accidents revealed that many of the failures that caused the accidents occurred shortly after periodic inspections. The report concluded that these human failures were caused by

1. Inadequate basic training in the relevant maintenance practices, policies, and procedures
2. Lack of training in maintenance of the types and modules of equipment being maintained
3. Inadequate or improper supervision
4. Inadequate inspection.

### **9-5.3.3 Contributing Factors**

Knowledge about human error can reduce the probability of damaged equipment or personnel injury by imposing human factors constraints on the equipment design. The characteristics that follow contribute to human errors and diminish the safety of person machine relationships (Ref. 7):

1. *Population Stereotypes.* A population stereotype is "the way most people in the population expect something to be". People expect, for example, that when a control is turned clockwise (except for flow control valves), the controlled function should increase. and vice versa.

2. *Performance Requirements in Excess of Human Capability for the Full Range of Maintainers.* Equipment design that exceeds the physical and psychological limits of human capability creates a high likelihood of accidents. For example, a design may require pitch or visual discrimination beyond the capability of human senses.

3. *Designs That Promote Fatigue.* Any design that makes personnel work harder than normally expected is likely to promote fatigue and increase error. For example, inadequate lighting produces eyestrain and fatigue. and excessive noise in the work environment increases the rate of fatigue.

4. *Inadequate Facilities or Information.* When personnel must perform tasks in inadequate facilities or without proper information, errors are likely to occur. For example, if the tolerances for instrument readings are not provided, personnel tend to assume tolerances they believe to be reasonable. Operator action based on

instrument indication may be too late or too inaccurate to be of value.

5. *Unnecessarily Difficult or Unpleasant Tasks.* When design results in tasks that are unpleasant or complex, personnel may not devote the proper amount of time and attention to attaining satisfactory performance. For example, if two adjustments of equipment interrelate so that precise setting and resetting are required to attain the proper value, personnel making the adjustments are more likely to stop short of the proper value than if the adjustments were independent. Also tasks that may get the technician excessively dirty or wet, such as crawling under a vehicle in a muddy field, will frequently be “overlooked”.

6. *Necessarily Dangerous Tasks.* Motivational characteristics, rather than performance capabilities, may intercede when personnel perform dangerous tasks. For example, personnel exposed to high voltages during preventive maintenance operations are less likely to perform tasks thoroughly, and as frequently as they would if the danger did not exist.

7. *Unpleasant Environments.* Proper environmental conditions must be maintained as much as possible so that the capability of the body’s regulatory mechanisms to sustain a constant internal environment is not strained. Optimum environmental conditions make minimal demands on the body’s self-regulatory mechanisms. (This relates to performance of unpleasant tasks discussed in Item 5.)

To minimize the possibility of human error in accomplishing any procedure involving a nuclear device, the Army has developed the “two-person concept”. Two or more persons, each capable of undertaking the prescribed tasks and of detecting incorrect or unauthorized procedures are involved. One person performs the task while the other checks to make sure the task has been performed correctly.

### 9-5.3.4 Quantification

There is a need to understand and predict the contribution of human error to reliability and maintainability parameters such as mean time between failure and mean time to repair. Both of these are characteristics of the hardware, but both are also influenced by human performance. In fact, there are some analyses that indicate that the majority of system failures are attributable to humans and not to hardware.

Much work has been done in human performance reliability (HPR). Yet a basic problem remains, i.e., lack of a good data base of human error and performance (Ref. 20). The models available are fairly sophisticated, but considering the poor quality of the data input to the models, the output should be used with caution. There are several HPR indices that differ both in scope and in type of model used. Two types—the technique for human error rate (THERP) and the Siegel-Wolf model—will be discussed.

The analytical or simulation THERP can be used to predict the total system or subsystem failure rate resulting from human errors (Ref. 21). The THERP methodology

begins with a task analysis that breaks the system into a series of personnel-equipment functional (PEF) units. The system being analyzed is then described by a functional flow diagram. Prediction data are assigned to each PEF. A computer program calculates the reliability of task accomplishment and performance completion time and takes into account dependent and redundant relationships.

The Siegel-Wolf digital simulation model is oriented toward the effects of time stress on the successful completion of the task. The model outputs are (Ref. 21)

1. Average time expended
2. Average peak stress
3. Average final stress
4. Probability of task success
5. Average waiting time
6. Sum of subtasks ignored
7. Sum of subtasks failed.

A good start on a data bank of human error rates has been made by the American Institute of Research (AIR) (Ref. 22). The AIR estimates of error rates are for average, trained military personnel with average motivation who are operating under normal conditions. However, very little work has been done to quantify the degradation of human performance under operational stress.

A second source of data results from an analysis of the maintenance data in the Army maintenance management system (TAMMS). Maintenance actions reported through TAM MS are analyzed and supplemented with independent judgments and arrive at quantitative values for human error data. Table 9-8 presents the results of a study that used this method, Human error rate estimates for a large system were derived from existing data of poor quality by modifying the data with the independent judgments of human reliability analysts. These judgments were made after reviewing information on personnel skill levels; previous jobs held by these personnel; procedures; and design of the control, displays, and other equipment read or manipulated by the personnel.

To date, the primary source of HPR information is subjective data based on expert opinion or objective data supplemented as necessary with subjective judgments. Techniques for developing expert estimates include the Delphi technique (Ref. 21).

## 9-6 PHYSICAL FACTORS

Physical factors are relevant in designing for maintainability; it is important that maintenance personnel be physically capable of performing required tasks. If they cannot, maintenance efficiency suffers.

Maintenance proficiency is directly affected by a wide variety of natural and induced environmental elements that degrade performance by interfering with a sensory process or by creating physiological or psychological stress. Stress is a function of many factors—e.g., fatigue, lack of training, worry, fear—that is exacerbated by the irritants of noise, vibration, and inclement temperature. The stress level rises to a point at which the person’s ability to perform in a satisfactory manner declines suddenly and markedly. Logically, the more severe the stress,

**TABLE 9-8. HUMAN ERROR RATE ESTIMATE DATA (Ref. 22)**

Estimated Rates	Activity
$10^{-4}$	Selection of a key-operated switch, rather than a nonkey switch. (The value does not include the error of decision where the operator misinterprets the situation and believes the key switch is the correct choice. )
$10^{-3}$	Selection of a switch (or pair of switches) dissimilar in shape or location to the desired switch (or pair of switches) assuming no decision error. For example, operator actuates a large-handled switch, rather than a small switch.
$3 \times 10^{-3}$	General human error of commission, e.g., misreading label and thereby selecting wrong switch.
$10^{-2}$	General human error of omission where there is no display in the control room of the status of the item omitted, e.g., failure to return a manually operated test valve to proper configuration after maintenance.
$3 \times 10^{-3}$	Errors of omission, where the items being omitted are embedded in procedure, rather than at the end as in the previous activity.
$3 \times 10^{-2}$	Simple arithmetic errors with self-checking but without repeating the calculation by redoing it on another piece of paper.
0.2-0.3	General error rate given very high stress levels where dangerous activities are occurring rapidly.

the sooner this point is reached. Accordingly, some of the environmental elements that interfere with the normal sensory process or heighten stress require study and measurement during engineering test (Ref. 3). Contributing environmental elements are

1. Illumination (discussed in par. 9-4.1)

2. Noise (discussed in par. 9-4.2)
3. Temperature and humidity (see Chapter 10)
4. Acceleration, shock, and vibration (see Chapter 10)
5. Toxicological, radiological, and electromagnetic hazards (see Chapter 10).

## REFERENCES

1. MIL-H-46855B, *Human Engineering Requirements for Military Systems, Equipment, and Facilities*, 5 April 1984.
2. MIL-STD-1472C, *Human Engineering Design Criteria for Military Systems, Equipment and Facilities*, 10 May 1984.
3. MIL-HDBK-759A, *Human Factors in Design of Army Materiel*, June 1981.
4. MIL-HDBK-743, *Anthropometry of US Military Personnel*, 3 October 1980.
5. Report TR EPT-2, *Reference Anthropometry of the Arctic-Equipped Soldier*, US Army Natick Laboratories, Natick, MA.
6. Report TR 72-51-CE, *The Body Size of Soldiers: US Army Anthropometry*, 1966.
7. DH 1-3, Design Handbook, *Human Factors Engineering*, AFSC, Wright-Patterson AFB, OH, Third Edition, March 1977.
8. J. W. Garrett and K. W. Kennedy, *A Collection of Anthropometry*, Aerospace Medical Research Laboratory, Wright-Patterson AFB, OH, 1971.
9. Harold P. VanCott and Robert G. Kinkade, *Human Engineering Guide to Equipment Designs*, Superintendent of Documents, US Government Printing Office, Washington, DC, 1972. (Revision of 1963 McGraw-Hill edition)
10. Woodson and Conover, *Human Engineering Guide for Equipment Designers*, University of California Press, Berkeley, CA, 1964.
11. Harold P. VanCott and Robert G. Kinkade, Eds., *Human Engineering Guide to Equipment Design*, McGraw-Hill Book Company, New York, NY 1963.
12. J. R. Mertney, et al., *Human Factors in Design, Energy Research and Development Administration Report*, ERDA 76-45-2.
13. DOD-HDBK-761, *Human Engineering Guidelines for Management Information Systems*, June 1985.
14. AMCP 706-133, *Engineering Design Handbook, Maintainability Engineering Theory and Practice*, January 1976.
15. TB ME D 501, *Occupational and Environmental Health: Hearing Conservation*, March 1980.
16. AR 611-201, *Enlisted Career Management Fields and Military Occupational Specialties*, 25 October 1985.
17. Field Circular 21-451, *I am the American Soldier*, US Army Soldier Support Center, Fort Benjamin Harrison, IN, 31 March 1985.
18. W. Hammer, *Handbook of System and Product Safety*, Prentice-Hall, Englewood Cliffs, NJ, 1972.
19. M. M. Berkun, "Performance Decrement Under Psychological Stress", *Human Factors* 6, 21-30 (1964).
20. David Meister, *Subjective Data in Human Reliability Estimates*, Reliability and Maintainability Conference, 1978.
21. *Human Reliability Prediction System User's Manual*, Department of Navy, Sea Command, December 1977.
22. A. D. Swain, *A Method for Performing a Human Factors Reliability Analysis*, Report SCR-685, Sandia Corporation, August 1963.

## BIBLIOGRAPHY

- A *A Collection of Anthropometry*, J. W. Garrett and K. W. Kennedy, Aerospace Medical Research Laboratory, Wright-Patterson AFB, OH, 1971.
- Engineering Anthropometry Methods*, J. A. Roebuck, H. E. Kroemer, and W. G. Thomson, John Wiley and Sons, Inc., New York, NY, 1975.

**This page intentionally left blank.**

## CHAPTER 10

### ENVIRONMENTAL FACTORS

*This chapter emphasizes the importance of the environment in which equipment will be operated or stored as a factor in establishing design criteria and evaluating maintainability features. The environmental factors—natural and induced—and combined environmental factors as they affect maintenance personnel and materiel are discussed.*

#### 10-1 INTRODUCTION

Environment is defined in MIL-STD-1165 (Ref. 1) as “the totality of natural and induced conditions occurring or encountered at any one time and place”. The natural and induced conditions (factors) are presented in par. 10-2. The description of the environment must be tailored for particular consideration according to the particular materiel type and to the challenge the materiel presents to personnel who must operate and maintain it. In different climates, the environmental factors vary in importance. For example, solid precipitant comprise an important factor in Alaska, but this factor is of no importance in the Panama Canal Zone. Similarly, rain is an important factor in the outdoor environment in the temperate zone but is unimportant inside a warehouse. The interior of a

warehouse, however, is an important region of the environment for materiel. Table 10-1 (Ref. 2) indicates the relationship of environmental factors to climatic types.

Certain combinations of environmental factors and climates exert various levels of effects on materiel and personnel—some more severe, others less severe. In the past it was considered impractical to design equipment to meet a specific climatic condition, i.e., equipment was designed to be operated and maintained in a worldwide environment. This philosophy is being challenged (Ref. 3) when nondevelopmental items (NDI) could satisfy an existing requirement. It is necessary to examine the practice of designing to the “worst case” scenario for all equipment. The design for all environmental conditions is a necessary approach for front-line combat materiel but may not make sense for materiel used in rear echelons or

**TABLE 10-1. RELATIONSHIP OF ENVIRONMENTAL FACTORS TO CLIMATE (Ref. 2)**

Factor	Intermediate	Arctic	Hot-Dry	Hot-Wet
Terrain	+++	+++	+++	+++
Low temperature	++	+++	0	0
High temperature	+	0	+++	++
Low humidity	0	0	++	0
High humidity	++	+	0	+++
Pressure	0	0	0	+
Solar radiation	+	++	+++	++
Rain	++	+	+	++
Fog	++	++	0	0
Solid precipitation	++	++	0	0
Whiteout and ice fog	0	++	0	0
Salt, salt fog, salt water	+	+	+	++
Wind	+	++	+	+
Ozone	*	*	*	*
Microbiological organisms	+	0	0	+
Microbiological organisms	+	0	0	+++
Atmospheric pollutants	*	*	*	*
Sand & dust	+	0	+++	+
Shock	*	*	*	*
Vibration	*	*	*	*
Acceleration	*	*	*	*
Acoustics	*	*	*	*
Electromagnetic radiation	*	*	*	*
Nuclear radiation	*	*	*	*

+++ Key factor

++ Important factor

+ Active factor

0 Unimportant or absent factor

\* Little or no climatic relationship

stateside. Let us take climatic hardening as an example. Do we need to harden the entire Army inventory of equipment to withstand an arctic climate when only 10% of the equipment is ever used there? Why not harden the 10% that is supposed to endure the environment or provide supplemental environmental protection in the form of kits or shelters? Accordingly, the maintainability engineer—before developing a maintainability plan -- should ascertain the decision of the Materiel Acquisition Review Board, Army Materiel Command, and the Army Training and Doctrine Command relative to the degree of hardness required.

Of the natural environmental factors, temperature and humidity represent the most severe environment for maintenance in the field. Extreme cold affects the technicians' ability to handle parts, and the heavy gloves make small parts virtually impossible to handle or manipulate. Heavy clothing interferes with access and impairs visibility. Cold temperatures also have a deleterious effect on many materials.

Hot climates also create poor working conditions. Extremely hot temperatures, particularly if associated with high relative humidity, have a debilitating effect on personnel. Hot climates also may create difficult working conditions. Hot, dry areas usually produce dust, which penetrates mechanical equipment and causes premature wear in moving parts. Where dust accumulates, it can absorb water; this may result in corrosion and electrical problems. Hot, wet areas—such as the tropics cause fungous growth in and on equipment.

Warfare, although not an induced environmental factor in the classical sense, is an important factor. Warfare neglecting increased materiel damage—causes severe maintenance problems because of the mental stress on the technician; he is concerned with both his position and the urgency to return equipment to a serviceable condition as rapidly as possible. The conditions of war may also make it difficult to obtain required repair parts and thus aggravate the situation.

Of the induced environmental factors, shock and/or vibration represent the most severe environment. Personnel performance—operator and maintenance—is adversely affected by the degree of the shock and/or vibration. These factors also can produce mechanical damage to materiel. Materiel experiences a variety of dynamic mechanical loads during movement i.e., from the origin of manufacture to the stockpile and from the stockpile to target. Some of these loads are intrinsic to the type of transport and handling; others are characteristic of the system itself or associated with inadvertent mishandling.

## **10-2 ENVIRONMENTS**

### **10-2.1 NATURAL, INDUCED, AND COMBINED**

The components, or descriptors, of the environment are referred to as factors. The factors (see Table 10-2 (Ref. 4)) are divided into natural and induced, defined as follows:

1. *Natural.* Those factors primarily natural in origin. It is notable that the importance of each of these factors may be altered by man and, in fact, of often is when protection is provided.

2. *Induced.* Those factors for which man's activities constitute the major contribution. These factors, resulting from man's activity, may be controlled to any extent deemed necessary and practical.

Table 10-2 also identifies the environmental factors as to class.

The term "combined environmental factors" is used in situations to identify combinations of environmental factors that frequently are observed arid that are associated by natural coupling. In their effects on materiel, many environmental factors act in conjunction or in synergism. In the conjunctive case are found examples of factors in pairs or in multiple combinations that are characteristic of geographic regions or other circumstances. Thus high temperature and high humidity often cooccur its do high temperature and airborne sand and dust. In the synergistic case two or more environmental factors act together to produce effects that are more important than the separate effects of either constituent. An example of synergism is the effect obtained with low temperature and vibration. With this combination of factors, rubber shock mounts that can survive either the severe cold or the severe vibrations readily are destroyed by the combined action of the two environmental factors. In similar fashion, the appearance of one environmental factor may inhibit the action of another e.g., high temperature inhibits solid precipitants, and low temperature inhibits attack by microbiological organisms. Time of exposure is an important factor when considering the effects of combined environmental factors. Table 10-3 (Ref. 2) summarizes the qualitative relationships between pairs of environmental factors.

For a detailed and sophisticated treatment of environmental factors definitions, concentrations or severity worldwide, methods of measurement, and effects on personnel and materiel refer to Refs. 2, 4, 5, and 6.

### **10-2.2 WARTIME ENVIRONMENTS**

Warfare—ignoring a worst case scenario of a "nuclear winter"—will have no effect on the naturally occurring environmental factors presented in par. 10-2.1. The induced environmental factors may be increased in intensity and effects due to the employment of nuclear and or chemical munitions. Enemy and friendly fire with the attendant noise although not classical environmental factors— must be considered in the total environment of warfare.

Maintenance operations, following a nuclear or chemical attack, will include decontamination. The guidance in the previous chapters as to permanent labels and the design of doors and external fixtures so as to drain readily and not act as liquid reservoirs will facilitate decontamination. Radiation that has been induced in materiel by a nuclear explosion cannot be removed by decontamination. Accordingly, to avoid possible overexposure of personnel, speed of repair is of the essence. The guidance in

TABLE 10-2. MAJOR ENVIRONMENTAL FACTORS (Ref. 4)

Type	Class	Factor
Natural	Terrain	Topography Hydrology Soils Vegetation
	Climatic	Temperature Humidity Pressure Solar radiation Rain Solid precipitant Fog Wind Salt Ozone
	Biological	Microbiological organisms Microbiological organisms
Induced	Airborne	Sand and dust Pollutants
	Mechanical	Vibration Shock Acceleration
	Energy	Acoustics Electromagnetic radiation Nuclear radiation

the previous chapters relative to simplicity, accessibility, and module replacement is, therefore, apropos.

Decontamination and working in a contaminated area will require a protective ensemble. The wearing of the protective mask, hood, overgarment, and gloves poses serious problems in functional efficiency and degradation. The overall ensemble imposes the problems of heat stress, loss of visual field and visual acuity, lens fogging with attendant loss of vision, and reduced tactility. The bulk of the protective ensemble must be evaluated as a function of the operators' and technicians' task (Ref. 7).

### 10-2.2.1 Chemical

A chemical (pollutant) environment can be created by the introduction of lethal and nonlethal chemical agents and riot control chemical agents. The chemical environment may result in the deposition of corrosive materials on materiel; if inhaled or deposited on bare skin, physiological and psychological changes to personnel will result.

### 10-2.2.2 Nuclear

The nature and severity of the contamination resulting from a nuclear detonation are a function of weapon yield and type of burst i.e., air, ground, or underwater. The fire and blast effects, except for magnitude, are identical with those associated with conventional weapons; the effects of the nuclear radiation are unique. Salvageable

equipment immediately after the event will be radioactive due both to induced nuclear radiation and fallout. The fallout can be removed by decontamination techniques, but the induced radiation will persist. The persistence of the radiation is a function of the material in which the radiation was induced. An electromagnetic pulse (EMP)—which has the potential for severely damaging electronic components and circuits—is associated with a nuclear detonation. Nuclear effects on materiel are presented in par. 10-3.2.1.7.

### 10-2.2.3 Electromagnetic Radiation

Ref. 6 is a thorough, scholarly presentation of electromagnetic radiation—sources, detection, measurement, and effects on man and materiel. Electromagnetic radiation is present in many maintenance environments and may be introduced by equipment related to the functions being performed or under the control of the technician subject to exposure. Basically, the electronic environment consists of two categories of radiation (Ref. 6), i.e., naturally occurring radiation and radiation generated by man-made equipment. The very low frequency band, i.e., less than  $10^4$  Hz, is not considered to be environmentally important because (1) the radiated power densities are relatively low and (2) at the long wavelengths, the energy absorption by materiel is negligible.

Although the electromagnetic environment is composed of emanations from a multiplicity of sources, only a



frequency spectrum allotted to the communications band generally are not believed to cause significant effects on personnel. On the other hand, it is documented and well-known that the effects of X rays, lightning strikes, high intensity light pulses, and even microwaves under the right combination of conditions can produce hazardous effects on personnel and can affect materiel (Ref. 6). Accordingly, the electromagnetic effects on personnel must be considered in the design of electronic equipment. Basically, the effects produced by electromagnetic fields on personnel are classified into thermal and nonthermal. Certain parts of the human physiology are particularly susceptible to certain frequencies of electromagnetic energy. One of the prime areas of concern involves the effects of microwaves. As an example, it is well documented that microwaves produce cataracts in the eyes of persons who are subjected to strong microwave fields for long periods of time. This is believed to be a thermal effect because there is no blood supply to the lens of the eye to carry away the heat of absorption. Other effects occur in humans, but cataracts seem to appear first. The importance of nonthermal effects is a source of scientific discussions; sufficient evidence is not yet present to specify the nonthermal effects that are both important and originate within the electromagnetic environment. Accordingly, since there is no consensus on the effects of electromagnetic radiation on personnel, the maintainability engineer should seek the expert advice of health physicists and medical personnel. Areas in which electromagnetic energy is present should be posted as indicated in Chapter 8.

**10-2.2.4 Enemy and Friendly Fire**

Enemy and friendly fire produce detrimental effects that are both psychological and acoustic. Psychological effects are related solely to personnel; acoustic effects can affect both personnel and materiel. By far the most significant aspect of sound to personnel is its relationship to communication by speech and hearing. Speech and its accurate perception are absolutely essential to the normal existence of humans; the fact that speech perception is affected adversely by excessive noise or by hearing loss is obvious. Consequently, every reasonable effort must be made to insure that the inadvertent hearing loss from friendly fire is minimized. Above certain sound intensity limits, exposure to sound has physical and physiological effects in addition to its effects on hearing. Sufficiently intense airborne sound can destroy materiel and kill exposed personnel (Ref. 6).

Sound pressure levels (SPL) of interest in the Army's acoustic environment cover roughly 20 decibel (dB) orders of magnitude, i.e., a 200-dB range. Any common Army small arms—all weapons up to and including cal. 50 and shotguns—produce impulse noise levels in excess of 140 dB. Most, if not all, of the mechanized equipment in the Army produces steady state noise environments that can interfere with direct person-to-person communication (Ref. 6). Table 10-4 (Ref. 6) relates sound levels to weapon sources. A detailed discussion of noise can be found in Appendix B, Ref. 7. Ref. 8 is the basic regulatory document governing maximum noise levels in Army equipment. Ref. 9 officially defines dangerous noise levels for the Army and specifies methods for controlling noise exposures and for conserving hearing in high-noise environments.

**10-3 EFFECTS OF ENVIRONMENTS**

**10-3.1 EFFECTS ON PERSONNEL**

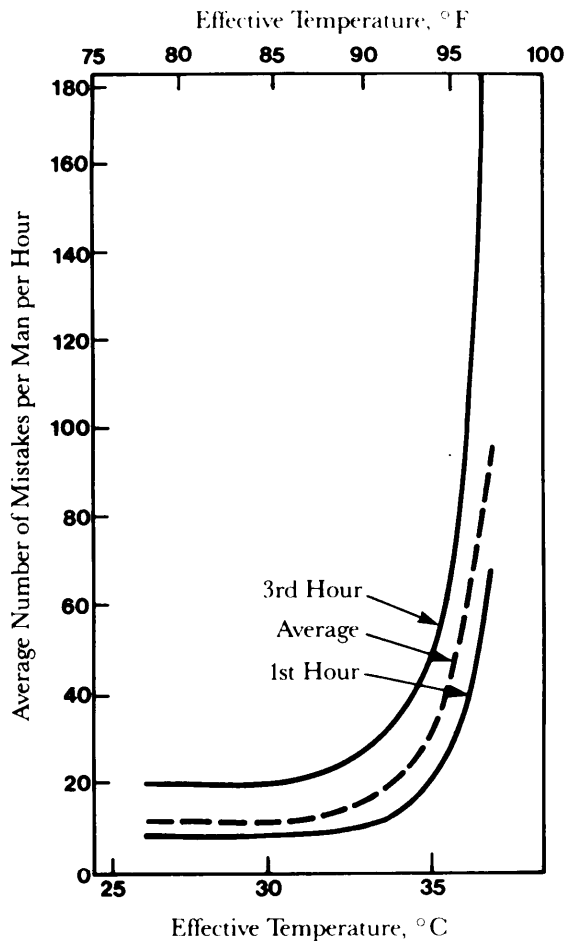
Each of the modified environments described in par. 10-2.2 has an adverse effect on personnel performing maintenance operations. Some affect comfort, some increase the time required to perform a maintenance action, and all may introduce a higher level of error than would an optimum maintenance environment. Successful maintainability design must also consider the normal environmental factors that affect the ability of personnel to perform at an optimum level of proficiency. Human error, comfort level, and some of the psychological effects of noise were discussed in Chapter 9.

**10-3.1.1 Temperature**

Although the effects of temperature on human performance are not completely understood, it is known that certain temperature extremes are detrimental to work efficiency. As the temperature increases above the comfort zone, mental processes slow down, motor responses are slower, motivation is reduced, and the likelihood of error increases. Fig. 10-1 illustrates the increased error rate with increasing effective temperature. Dry-bulb temperature is not the sole criterion in relating temperature to comfort or efficiency; humidity and airspeed are important considerations. The discussion of effective temperature, Wet-Bulb Global Index, and Windchill Index in the paragraphs that follow presents this inter-relationship.

**TABLE 10-4. SOUND LEVELS ASSOCIATED WITH WEAPON TYPES (Ref. 6)**

Sound Level		Typical Source	Significance or Action Required
db	$\mu$ bar		
140-170	0.010-0.012	Small arms	Hearing protection required for repeated exposure
175-190	0.0125-0.014	Artillery	Hearing protection essential; body protection desirable



**Figure 10-1. Error Increase Due to Rise in Effective Temperature**

**10-3.1.1.1 Effective Temperature**

The effective temperature (ET) of an environment is an empirical thermal index that considers how combinations of dry-bulb air temperature, humidity, air movement, and clothing affect people (Ref. 7). Numerically, the ET is equal to the temperature of still saturated air, which would give the same sensation. The effective temperature may be read from Fig. 10-2 (Ref. 7).

The optimum temperatures for personnel vary according to the nature of the tasks performed, the conditions under which the tasks are performed, and the clothing the personnel are wearing. For maximum physical comfort while normally dressed appropriate to the season or climate, the optimum range of effective temperature for accomplishing light work is (Ref. 7)

1. 21° to 27°C (70° to 81°F) in a warm climate or during summer
2. 18° to 24°C (64° to 75°F) in a colder climate or during winter.

Fig. 10-3 (Ref. 7) indicates summer and winter comfort zones and thermal tolerances in hours for inhabited areas.

**10-3.1.1.2 Wet-Bulb Global Temperature**

For military personnel who must work outside in hot climates in ranges beyond the comfort and discomfort zone of heat stress—the Wet-Bulb Global Temperature (WBGT) Index is more applicable than the ET Index. The WBGT Index takes into consideration dry-bulb temperature; relative humidity calculated with ambient air movement, rather than at a standardized rate; and the solar, or radiant, heat load. This index and its use are described in Ref. 11. The WBGT is calculated as follows (Ref. 7):

$$WBGT = 0.7T_{WB_{np}} + 0.2T_g + 0.1T_A, \text{ } ^\circ\text{C} \tag{10-1}$$

where

$T_{WB_{np}}$  = natural, wet-bulb, nonpsychrometric temperature, °C (Temperature read from a “natural” wet-bulb thermometer with a wettable wick exposed to ambient air motion and extending into a water reservoir.)

$T_g$  = temperature, representing radiant heat, measured at the interior of a 152-mm (6-in.) black globe, °C

$T_A$  = shaded dry-bulb air temperature, °C.

Generally, the activities of unacclimatized individuals are restricted when the WBGI exceeds 25°C (77°F) (Ref. 7). See Refs. 7 and 12 relative to the WBGT Index and limits of heat exposure.

**10-3.1.1.3 Windchill Index**

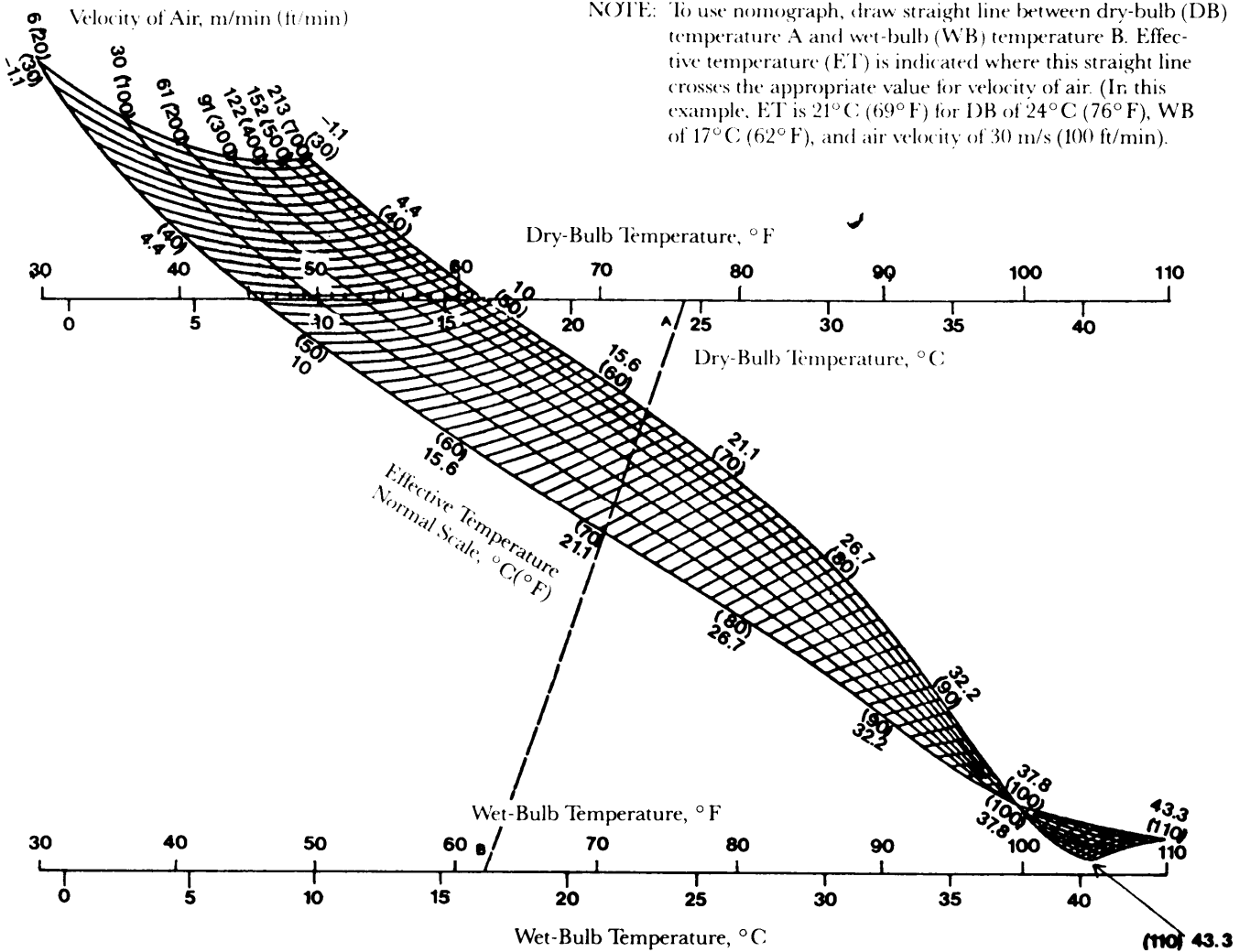
No general index, such as effective temperature, is available for expressing all the factors involved in cold exposure, but the Windchill Index commonly is used to express the severity of cold environments. Although windchill is not based on physical cooling and is probably not very accurate as an expression of human cooling, it has come into use as a single-value, practical guide to the severity of temperature-wind combinations. Fig. 10-4 (Ref. 7) portrays a windchill chart. Note, for example, -40°C (-40° F) with air movement of 0.1 m/s (0.3 ft/s) (see Line A) has the same windchill value and, therefore, the same sensation on exposed skin—as 24°C (-13°F) with a 0.5-m/s (1.5-ft/s) wind (see Line B). The Windchill Index does not account for physiological adaptations or adjustments, however, and should not be used rigorously. A qualitative description of human reaction to windchill values on exposed skin is shown in Table 10-5 (Ref. 7).

**10-3.1.1.4 Guidelines for Maintenance Operations in Extreme Climates**

Guidelines for operations in a hot climate follow:

1. Where possible, provide air conditioning if temperatures exceed 32°C (90°F). Proper ventilation should be provided in equipment trailers or other locations where personnel are monitoring, servicing, or performing other maintenance tasks.

NOTE: To use nomograph, draw straight line between dry-bulb (DB) temperature A and wet-bulb (WB) temperature B. Effective temperature (ET) is indicated where this straight line crosses the appropriate value for velocity of air. (In this example, ET is 21°C (69°F) for DB of 24°C (76°F), WB of 17°C (62°F), and air velocity of 30 m/s (100 ft/min).



Clothing: Customary indoor clothing

Activity: Sedentary or light muscular work

Heating Methods: Convection type—i.e., warm air, direct steam or hot water radiators, plenum systems

Figure 10-2. Deriving Effective Temperature

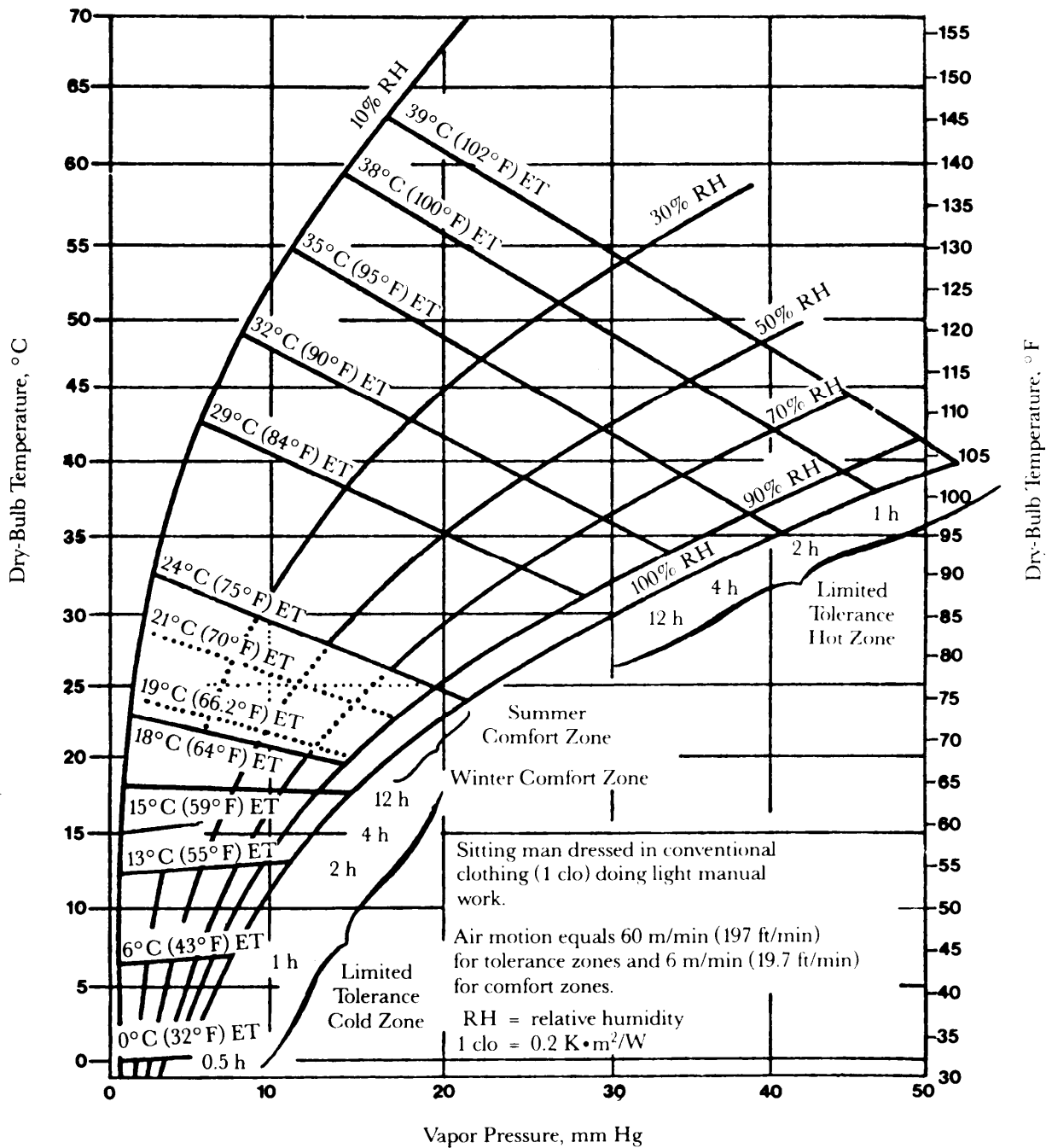


Figure 10-3. Summer and Winter Comfort Zones and Thermal Tolerances for Inhabited Compartments

$$K_o = (\sqrt{WS \times 100} - WS + 10.5)(33 - T_a), \text{ kcal/m}^2 \cdot \text{h}$$

where

$WS$  = windspeed, m/s

$T_a$  = air temperature, °C

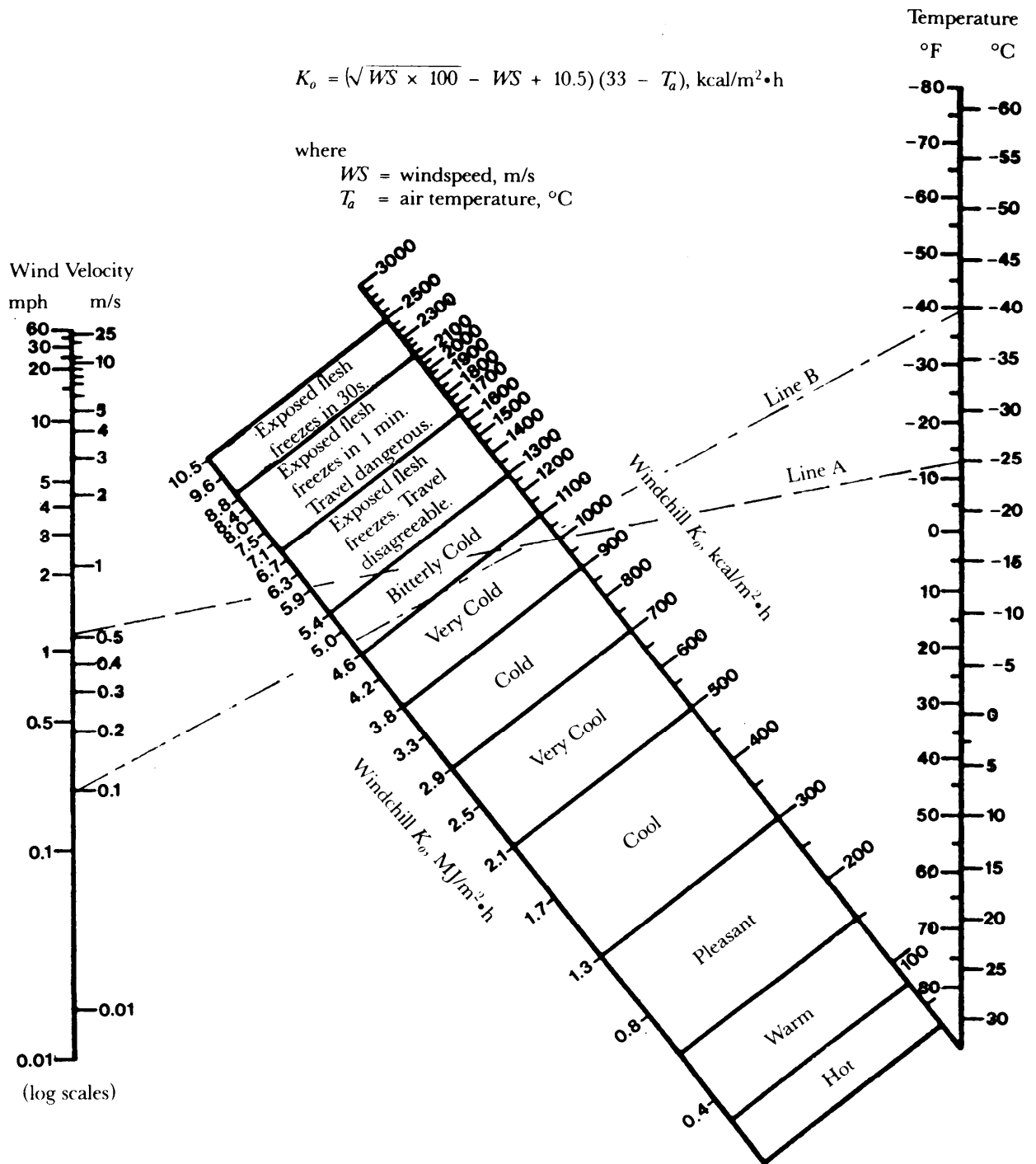


Figure 10-4. Windchill Chart

**TABLE 10-5. HUMAN REACTION TO WINDCHILL VALUES (Ref. 7)**

Windchill Values (See Fig. 10-4)	Human Reaction
100	Warm
400	Pleasant
800	Cold
1000	Very cold
1200	Bitterly cold
1400	Exposed flesh freezes

2. When it is necessary for maintenance technicians to work for extended periods inside equipment exposed to the sun, provide either permanent or portable air conditioning.

3. When maintenance technicians will be required to work for extended periods on equipment in open air, provide canopies for shade from direct sun.

4. Where feasible, employ reflective or absorbent surfaces, as appropriate, on equipment that must be maintained while exposed to the sun.

5. Where excessive temperatures interfere with frequent maintenance, redesign the equipment so that the component needing checking or adjustment is in a cooler area. If this is not possible, it may be feasible to provide for cooling of the component in place.

Guidelines for operating in a cold climate follow:

1. Provide heated working areas for maintenance personnel in arctic environments. For unit maintenance activities, specify procedures and design equipment that require a minimum sustained amount of working time. For example, use quick-disconnect servicing equipment.

2. Provide for drying of equipment that is to be returned to outdoor arctic temperatures after shop maintenance. Moisture that condenses on or in such equipment will freeze and possibly cause damage.

3. Design for maintenance accessibility of winterized equipment in arctic zones. Consider the following:

a. Winterization equipment, such as preheater, should be placed where it does not interfere with accessibility for inspection, servicing, or other maintenance tasks.

b. When locating access doors and panels, consider the formation of ice and the presence of snow or rain.

c. Provide access openings and work space large enough to accommodate personnel wearing arctic clothing.

d. Provide drains that can be operated by personnel wearing heavy gloves. Drains should be easily accessible and properly located to insure draining of liquids to prevent damage caused by freezing.

4. Where a technician's bare hands can freeze to cold metal or other cold surfaces when performing maintenance operations, provide sufficient access and internal work space to permit wearing of protective gloves.

**10-3.1.2 Other Climatic Factors**

The other climatic environmental factors listed in Table 10-2 are of less concern than the temperature extremes previously discussed. The protective measures that minimize the efforts of high temperature will also offer protection against solar radiation. Precipitation, blowing sand, and blowing dust will usually require protective clothing; unfortunately, this reduces the effectiveness of the technician and results in increased maintenance time.

**10-3.1.3 Whole-Body Vibration**

ISO DIS 2631, *Guide to the Evaluation of Human Exposure to Whole-Body Vibration* (Ref. 12), provides data to assess the effects of vibration and motion on humans. Equipment design should limit whole-body vibration to levels that permit safe operation and maintenance.

Fig. 10-5 (Ref. 7) shows the maximum allowable exposure times that will maintain proficiency for different combinations of acceleration and frequency levels. For instance, the maximum exposure time for an acceleration of 0.5 m/s<sup>2</sup> and a frequency of 1.6 H7 in the longitudinal direction is 8 h (Point A). For acceleration and frequency level combinations above the 8-h curve, exposure time must be reduced accordingly to maintain proficiency. In case of multidirectional vibration, each direction is to be evaluated independently with respect to limits presented in Fig. 10-5.

Limits on whole-body vibration to accommodate the human body follow (Ref. 7):

1. *Safely Limits.* To protect the human body, whole-body vibration should not exceed twice the acceleration values in Fig. 10-5 for the times and frequencies indicated.

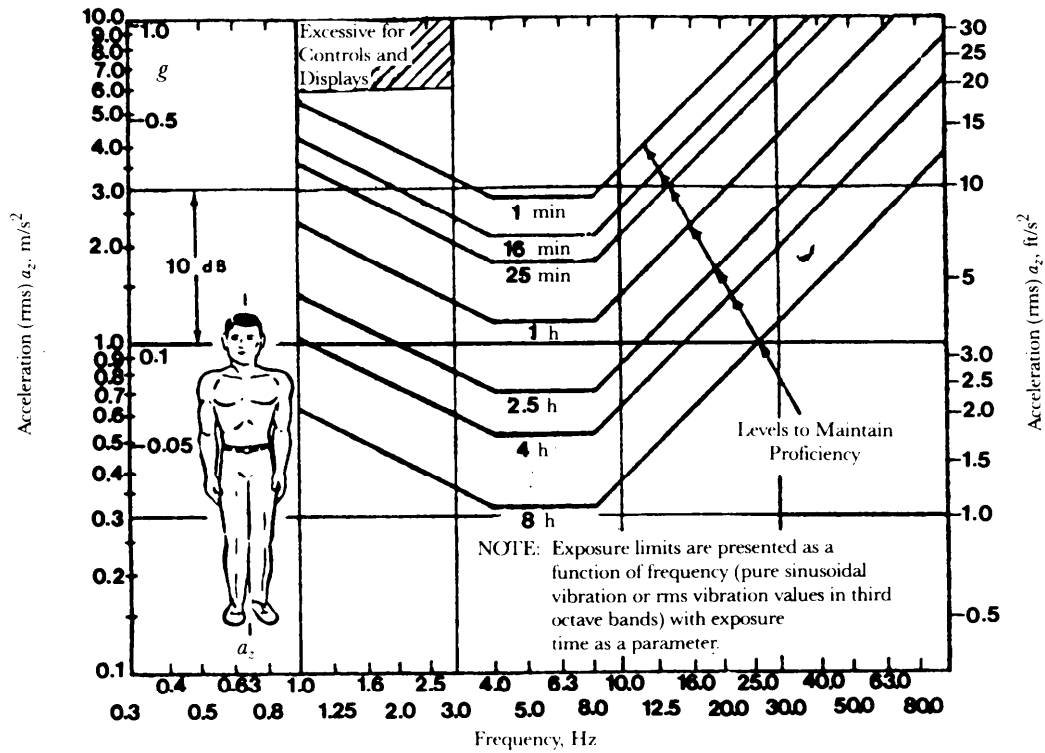
2. *Proficiency Levels.* When proficiency is required for operational and maintenance tasks, whole-body vibration should not exceed the acceleration values in Fig. 10-5 for the times and frequencies indicated.

3. *Comfort Level.* Where comfort is to be maintained, the acceleration values in Fig. 10-5 for a given frequency should be divided by 3.15.

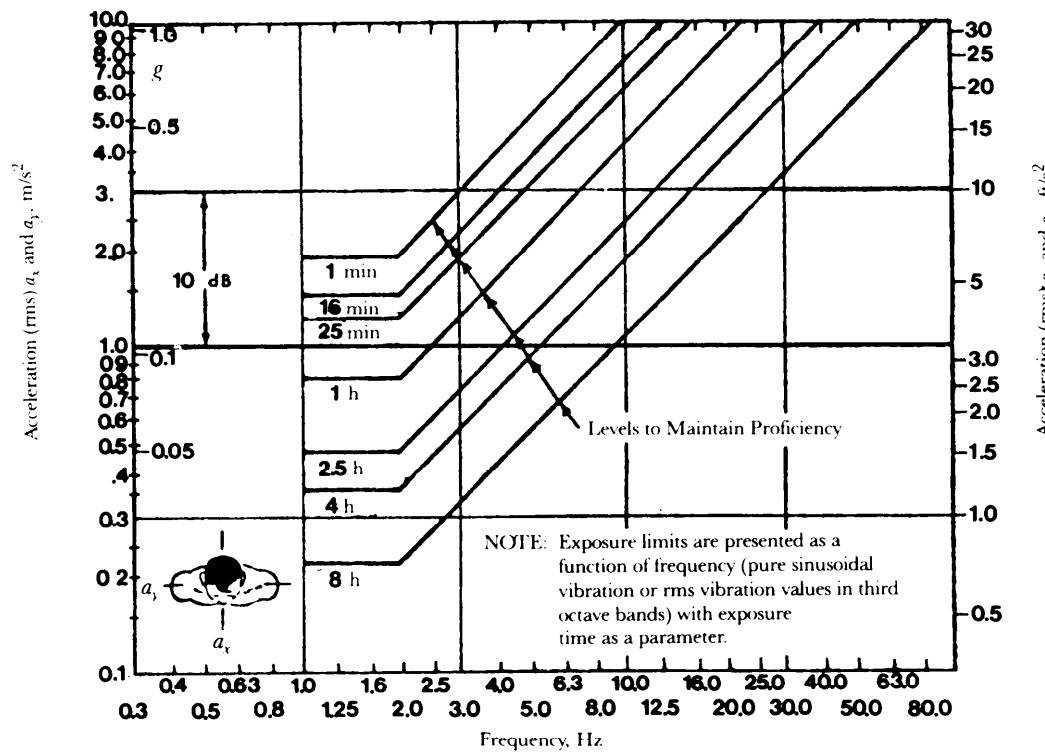
4. *Motion Sickness.* Very low frequency vertical vibration should not exceed the limits given in Fig. 10-6 (Ref. 7) to protect 90% of the unadapted males from vomiting in the exposure time indicated.

Where both whole- and part-body vibrations are not a factor, equipment should be designed so that oscillations will not impair human performance with respect to control manipulations or the readability of numerals and letters. Such equipment should be designed to preclude vibrations in the shaded area of Fig. 10-5(A).

Vibration may be detrimental to the maintenance technician's performance of both mental and physical tasks. Large amplitude, low frequency vibrations contribute to motion sickness, headaches, fatigue, and eyestrain, and they interfere with depth perception and the ability to read and interpret instruments. Exposure to continual, high-speed vibrations promotes worker fatigue and decreases worker proficiency. The designer can reduce and



(A) Longitudinal



(B) Transverse

Figure 10-5. Vibration Criteria for Longitudinal and Transverse Directions With Respect to Body Axes

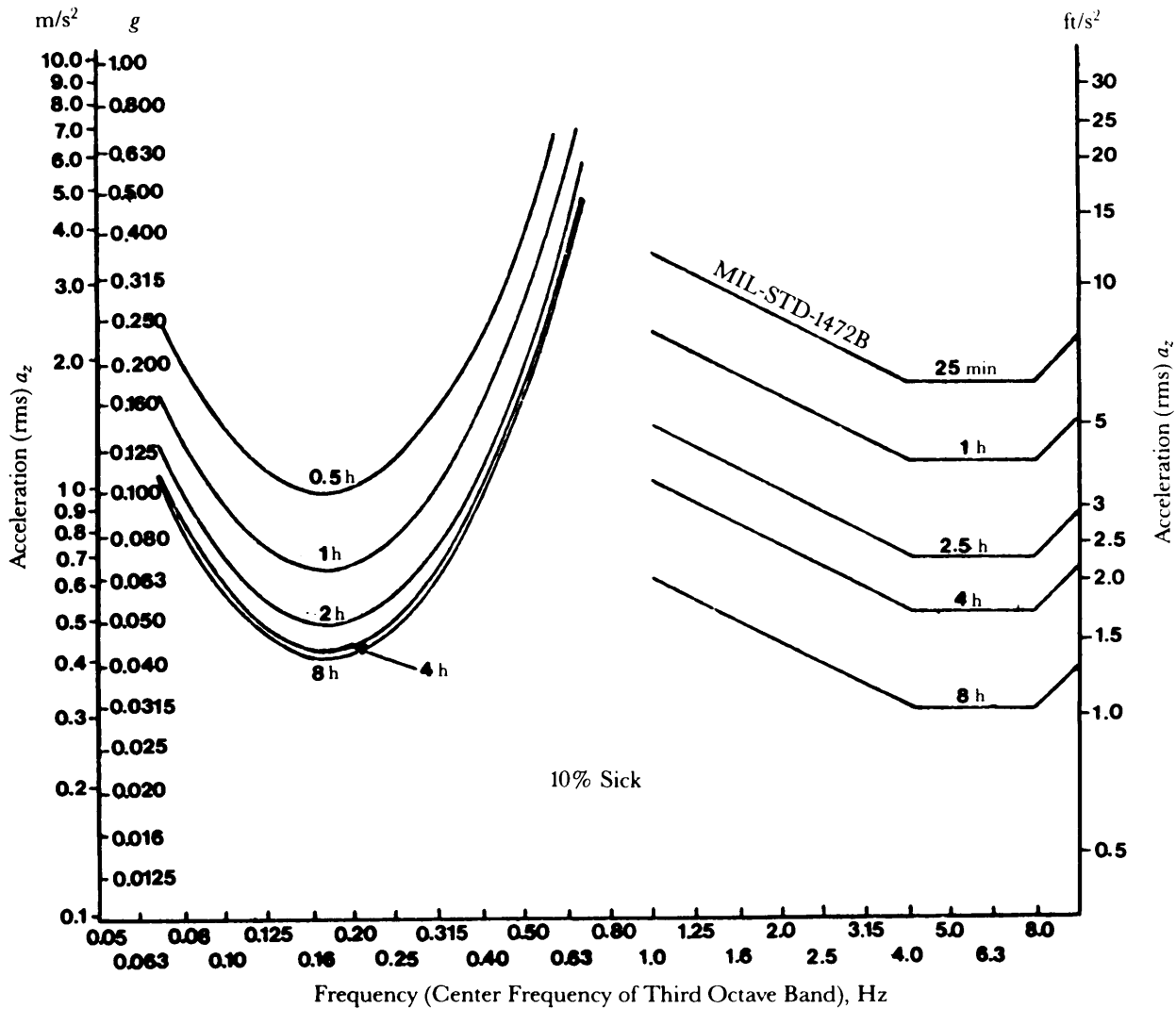


Figure 10-6. 90% Motion Sickness Protection Limits for Human Exposure to Very Low Frequency Vibration

control vibration by isolation, proper balancing of rotating machinery, and provision of damping materials or cushioned seats for personnel.

### 10-3.1.4 Terrain Factors

The terrain factors listed in Table 10-2 do not affect the performance of maintenance personnel directly. These factors may make it more difficult to arrive at the scene where maintenance is required or to recover materiel that requires maintenance. The terrain factors may also make it more difficult to locate a suitable shop area.

## 10-3.2 EFFECTS ON EQUIPMENT

Equipment must be designed for ease of maintenance in the environments identified in Table 10-2 and discussed in par. 10-2. The risk of failure due to natural and induced environmental factors and their combined effects must be minimized to limit the maintenance demand. Accord-

ingly, environmental design criteria should be included in maintainability considerations. The maintainability factors of simplicity, ease of access, location of drains, permanent identification of parts, etc., have been discussed in previous chapters; it is important that they be applied with consideration to the expected environment. The maintainability engineer must be aware of the specific environment in which materiel will be operated and maintained in order to develop a comprehensive maintainability plan.

The current philosophy that equipment must be designed to operate anywhere in the world has added climatic and terrain factors to the performance efficiency evaluation criteria. The destructive effects of induced environmental factors—e.g., shock, vibration, and chemical agents—and natural environmental factors e.g., wind, sand, dust, humidity, and solar radiation—are not to be ignored. However, they play a minor role when compared to the relentless attack of induced moisture-

either directly or in support of biological and galvanic actions. The combined effects of moisture and high ambient temperatures are more destructive than all other factor combinations. The next most destructive factor is low ambient temperature, a condition which makes materials more sensitive to rapidly applied loads. The destructive actions resulting from moisture and temperature can be guarded against by a combination of design, materials, protective finishes, and packaging. For example, avoiding dissimilar bare metal contact—i. e., metals far apart in the galvanic series indicated in Fig. 8-9 will prevent corrosion resulting from galvanic action.

MIL-HDBK-721 (Ref. 13) provides detailed coverage of corrosion and the protection of metals. MIL-E-5400 (Ref. 14) and MIL-E-16400 (Ref. 15) list acceptable corrosion-resistant materials.

**10-3.2.1 General Considerations**

**10-3 .2.1.1 Moisture Protection**

The exclusion of moisture from equipment in the tropics considerably eases maintenance problems. For example, Fig. 10-7 illustrates the effect of moisture in lowering the resistance of insulating materials. To help minimize such effects in insulation and other materials, the following guidelines should be considered:

1. Choose materials with low moisture-absorption

qualities wherever possible.

2. Use hermetic sealing whenever possible. Make sure the sealing area is kept to a minimum to reduce danger of leakage.

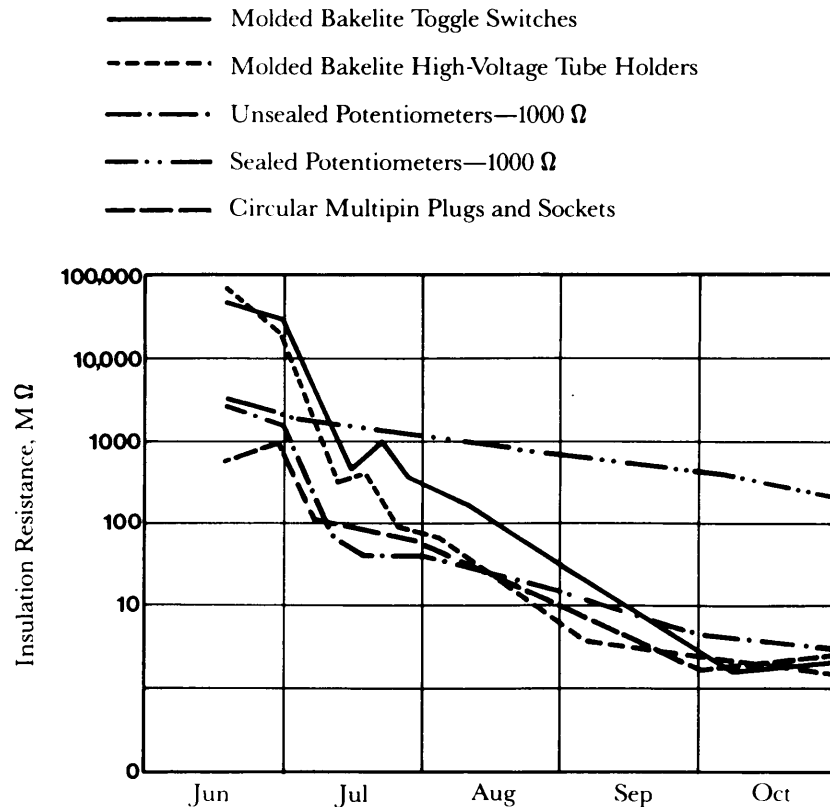
3. Where hermetic sealing is not possible, consider the use of gaskets and other sealing devices to keep moisture out. Insure that the sealing devices do not contribute to fungal activity, and allow for detection and elimination of any “breathing” that may admit moisture.

4. Consider impregnating or encapsulating materials with fungus-resistant hydrocarbon waxes and varnishes. This also will prevent wicking.

5. Do not place corrodible metal parts in contact with treated materials. Glass and metal parts might support fungal growth and deposit corrosive waste products on the treated materials.

6. When treated materials are used, make sure they do not contribute to corrosion or alter electrical or physical properties.

Where these methods are not practical, drain holes should be provided, and chassis and racks should be channeled to prevent moisture traps. Additional information on moisture protection can be supplied by the Prevention of Deterioration Center, National Research Council, 2101 Constitution Avenue, Washington, DC 20037. Refer also to MIL-E-5400 (Ref. 14) and MIL-E-16400 (Ref. 15) for listings of acceptable moisture-resistant materials.



**Figure 10-7. Reduction in Insulation Resistance of Typical Electronic Components Exposed For Five Months in Tropical Jungle**

**10-3.2.1.2 Desert Regions**

Desert regions occupy approximately 19% of the land surface of the earth. The outstanding attribute of all deserts is dryness. A widely accepted definition of "desert" is an area with an annual rainfall of less than 254 mm (10 in.). Hot deserts are further characterized by a clear atmosphere and intense solar radiation, both of which result in temperatures as high as 52°C (126°F) and ambient illumination levels as high as 10,280 cd/m<sup>2</sup> (3000 ftL) (Ref. 16). This intense solar radiation combined with terrain that has a high reflectance can create high levels of glare. Other characteristic phenomena associated with deserts are atmospheric boil and mirages. Design for desert areas should also consider sand and dust, which nearly always accompany dryness.

The high daytime temperatures, solar radiation, dust, and sand combined with sudden violent winds and large daily temperature fluctuations may create many of the following maintenance problems:

1. Heat can lead to difficulties with electronic and electrical equipment, especially if they have been designed for moderate climates.
2. Materials—such as waxes—soften, lose strength, and melt.
3. Materials may lose mechanical or electrical properties because of prolonged exposure.
4. Fluids may lose viscosity.
5. Joints that would be adequate under most other conditions may leak.

Heat can also cause the progressive deterioration of many types of seals found in transformers and capacitors. Capacitors of some types develop large and permanent changes in capacity when exposed to temperatures above 49°C (120°F).

The temperature extremes for electronic equipment operating in a desert environment are shown in Table 10-6. The following factors also should be considered:

1. Dry cells have a short life in hot environments and deteriorate rapidly at temperatures above 35° C (95° F).
2. Wet batteries lose their charge readily.
3. Tires wear out rapidly.
4. Paint, varnish, and lacquer crack and blister.

In the desert, relays, all types of switching equipment, and gasoline engines are susceptible to damage by sand

and dust. Sand and dust hazards present severe problems to finely machined or lubricated moving parts of light and heavy equipment. Sand and dust get into almost every nook and cranny and in engines, instruments, and armament. Desert dust becomes airborne with only slight agitation and can remain suspended for hours so that personnel have difficulty seeing and breathing. The most injurious effects of sand and dust result from their adherence to lubricated surfaces, but glass or plastic windows and goggles can be etched by sand particles driven by high winds.

**10-3.2.1.3 Arctic Regions**

In arctic regions the mean temperature for the warmest summer month is below 10°C (50°F), and for the coldest month, it is below -32°C (-25°F). The extremely low temperatures of these regions change the physical properties of materials. Blowing snow, snow and ice loads, ice fog, and windchill cause additional problems.

Problems associated with the operation and maintenance of equipment seem to be more numerous in arctic regions than elsewhere and are caused mainly by drifting snow and extremely low temperatures. The temperature extremes to which electronic equipment may be exposed are shown in Table 10-7.

With the exception of inhabited areas, vehicle transportation is uncertain and hazardous because of the absence of roads. Travel from base to base is over rugged, snow-and-ice or tundra-covered terrain. Drifting snow can enter a piece of equipment and either impede its

**TABLE 10-7. ARCTIC TEMPERATURE EXTREMES FOR ELECTRONIC EQUIPMENT**

Conditions	Temperature
Low temperature, driving snow, ice dust	Exposed arctic: -70°C (-94°F), extreme -40°C (-40°F), common Subarctic: -25°C (-13°F), common

**TABLE 10-6. TEMPERATURE EXTREMES FOR ELECTRONIC EQUIPMENT OPERATING IN A DESERT ENVIRONMENT**

Conditions	Temperature
Dry heat, intense sunlight, sand dust, destructive insects	Day high: +60°C (+140°F), air +75°C (167°F), exposed ground Night low: -10°C (+14°F) Large daily variation: 22°C (72°F), average  Relative humidity 5%

operation or melt and then refreeze inside. Then, when the unit generates heat, the melted ice can cause short circuits, form rust, or rot organic materials.

The subzero temperatures may produce the effects that follow:

1. Volatility of fuels is reduced.
2. Waxes and protective compounds stiffen and crack.
3. Rubber, rubber compounds, plastics, and metals lose their flexibility, become hard and brittle, and are less resistant to shock.

At a temperature of  $-34^{\circ}\text{C}$  ( $-30^{\circ}\text{F}$ ) batteries are reduced in current capacity by 90% and will not take an adequate charge until warmed to  $2^{\circ}\text{C}$  ( $35^{\circ}\text{F}$ ). The variations in the capacitance, inductance, and resistance of electrical components and parts can become great enough to require readjustment of critical circuits.

#### 10-3.2.1.4 Vibration (Ref. 6)

Vibration in the environment can degrade materiel in several ways, i.e.,

1. Malfunction of sensitive, electric, electronic, and mechanical devices
2. Mechanical and or structural damage to structures both stationary and mobile
3. Excessive wear in rotating parts
4. Frothing or sloshing of fluids in containers.

Table 10-8 (Ref. 6) indicates the effects of vibration on electrical and electronic equipment.

When vibration becomes severe enough to cause malfunction or failure, measures must be taken to permit materiel to survive in such an environment. The process of reducing the effects of the vibration environment is known as vibration control and consists of varying structural properties such as inertial, stiffness, and damping properties of mechanical systems to attenuate the amount of vibration transmitted to the materiel or to reduce the effects of the transmitted vibration.

A variety of techniques can attenuate vibration. Obviously, a very effective method is to remove the vibration at its source. Damping, i.e., a process of producing a continuing decrease in the amplitude of the vibration, also may be employed. This is accomplished by employing frictional losses that dissipate the energy of the system, i.e., an energy-absorbing mechanism. Detuning or decoupling a member from a resonant frequency can also be used.

#### 10-3.2.1.5 Shock (Ref. 6)

Equipment subjected to shock loads responds in a complex manner. The shock load can overstress and deform the basic equipment structure or damage fragile components attached to the structure. Both responses exist together, and their relative intensities are a function of the shape, duration, and intensity of the shock pulse; the geometrical configuration; total mass; internal mass distribution; stiffness distribution; and damping of the item or equipment. The effects of shock include breakage of brittle or fragile components, displacement of massive

components, and change in geometrical relationship among components.

To protect against shock, it is necessary to

1. Isolate the equipment from the shock forces through proper packaging and stowing techniques
2. Design equipment in a way that will make it unsusceptible to the shock environment.

Though not a shock in the classical sense, damage that can be introduced by electrostatic discharge during normal handling of modern electronic devices mandates that the potential for damage be controlled. By proper packaging and methods of discharging static electricity from workers and tools, the sensitive components handled during manufacture, test, and repair can be protected (Ref. 17).

Fundamentals of package design, barrier, cushioning, and container material are discussed in Refs. 18, 19, and 20.

#### 10-3.2.1.6 Acceleration (Ref. 6)

Most items of materiel are designed to operate within a narrow band of accelerating forces centered on the normal gravitational force of 1G. When accelerations differ appreciably from 1G, items fail to operate properly. The effects of large accelerations on equipment include structural and mechanical failures, abnormal operation of electron tubes, characteristic changes in vibration isolators, and malfunctions due to deformation of parts. Typical effects of acceleration on various types of equipment and components are listed in Table 10-9 (Ref. 6).

The primary means of protecting materiel against damage from the acceleration environment is through proper packaging. Other techniques include the use of shock mounts; the selection and use of the correct types of materials in terms of weight, strength, and flexibility; and proper structural mounting of component parts.

#### 10-3.2.1.7 Nuclear Radiation

The effects of nuclear radiation are derived from the amount of energy deposited within a material by the radiation and the form that the energy deposition assumes. Thus if a material absorbs little radiation, it may be unaffected in many applications. If the energy deposition is large, however, a material may lose its structural integrity. Most effects fall inbetween these two extremes. Solid-state electronic devices, for example, are extremely sensitive to nuclear radiation effects because their operation is very sensitive to the structure of the material. Absorbed radiation that ionizes an atom or displaces an atom in a semiconductor will affect the operation of a device that uses the semiconductor.

Damage to materials is classified into two categories, i.e., transient radiation damage and permanent radiation damage. This categorization is derived from the fact that many incidents of nuclear radiation in the environment are transient and produce transient effects in material. The magnitude of such effects decays with time, and the performance of materiel exposed to a transient radiation event often will return to its initial state. Transient effects usually are associated with low radiation doses. Rela-

**TABLE 10-8. VIBRATION-INDUCED DAMAGE TO ELECTRICAL  
AND ELECTRONIC EQUIPMENT (Ref. 6)**

Component Category	Damage Observations
Cabinet and frame structures	Among some 200 equipment cabinet and frame structures subjected to shock and vibration, damage included 30 permanent deformations, 17 fractures in areas of stress concentration, two fractures at no apparent stress concentrations, 23 fractures in or near welds, and 26 miscellaneous undefined failures.
Chassis	Nearly 300 chassis subjected to shock and vibration experienced 18 permanent deformations, eight fractures in or near welds, nine fractures at no apparent stress concentrations, 46 fractures at points of stress concentration, and 12 miscellaneous failures.
Cathode-ray tubes	Cathode-ray (CR) tubes are susceptible to vibration damage if they are improperly mounted and supported. CR tubes with screens larger than 5 in. are particularly susceptible. Of 31 cathode-ray tubes subjected to shock and vibration, the deflection plates of one tube became deformed, another had a filament failure, five suffered envelope fractures, and one had a glass-socket seal break.
Meters and indicators	Although the moving coil type of meter comprises the majority of units in this category, other indicators such as Bourdon tubes and drive-type synchros were also tested. Of the latter group, most of the failures were either erratic performance or zero shift difficulties. Nearly 200 units were subjected to shock and vibration. Two suffered permanent deformation of the case, one had elements loosened, 12 gave erratic readings, one had the glass face fractured, two developed internal open circuits, two had loose or damaged pivots, three had deformed pointers, and 10 others failed from miscellaneous causes.
Relays	Relays present a particularly difficult problem for dynamic conditions because of the difficulty in balancing all of the mechanical moments. Shock generally causes failure in the form of the armature failing to hold during the shock. A total of 300 relays were subjected to shock and vibration. Armature difficulties accounted for 29 defects, four relays had contacts fuse or burn because of arcing, one had the coil loosened on the pivots, two had the springs disengaged from the armature, and four sustained miscellaneous defects.
Wiring	Wiring failure from shock and vibration is a serious problem. A defect not only results in malfunctioning of the equipment, but presents a difficult troubleshooting job in locating the wire break. In a number of equipments subjected to shock and vibration, the failures were as follows: 10 cold solder joints opened, 14 lead-supported components had the leads fail, insufficient clearance caused three cases or arcing, and insufficient slack caused nine lead failures. In addition, three plastic cable clamps fractured, 14 solder joints or connections failed, 16 solid conductor wires broke, and 92 sustained miscellaneous failures.
Transformers	In electronic equipments transformers are probably the heaviest and densest components found on an electronic chassis. Because of the weight and size of transformers, shock and vibration are more likely to produce mechanical rather than electrical failures. Although not all mechanical failures immediately prevent the transformer from functioning properly, they eventually result in destruction of the transformer and damage to surrounding components. Of 80 transformers subjected to shock and vibration, 17 had the mounting stubs break at the weld, four had the bottom frame fail, and two suffered broken internal leads due to motion of the coil in the case.

**TABLE 10-9. EFFECT OF ACCELERATION ON MILITARY EQUIPMENT (Ref. 6)**

Item	Effect
Mechanical: moving parts, structures, fasteners	Pins may bend or shear; pins and reeds deflect; shock mounts may break away from mounting base; mating surfaces and finishes may be scored.
Electronic and electrical	Filament windings may break; items may break away if mounted only by their leads; normally closed pressure contacts may open; normally open pressure contacts may close; closely spaced parts may short.
Electromagnetic	Rotating or sliding devices may be displaced; hinged part may temporarily engage or disengage; windings and cores may be displaced.
Thermally active	Heater wires may break; bimetallic strips can bend; calibration may change.
Finishes	Cracks and blisters may occur.
Materials	Under load, materials may bend, shear, or splinter; glue lines can separate; welds can break.

tively larger amounts of deposited energy, however, produce permanent and accumulative damage.

The design of material that will be exposed to a nuclear radiation environment can be extremely complex. Of prime consideration is the radiation level for which the item is being designed. For example, in the design of semiconductor devices for nuclear radiation environments, the use of gold—which has a large absorption cross section—is sometimes avoided. For items that are sensitive to radiation, the use of lead shielding is employed. In electronic circuits, for example, knowledge of the radiation sensitivity of particular circuit elements is employed in the design to provide for continued operation of the circuit even when the properties of the sensitive elements may vary within wide limits.

In addition to blast, fire, and radiation resulting from a nuclear explosion, a large electrical charge is transported in a short period of time. This produces a large transient pulse of electromagnetic energy known as electromagnetic pulse (EMP). The EMP can be considered to be very similar to the common phenomenon of a lightning stroke. The magnitude and extent of EMP far exceeds electromagnetic fields created by any other means; its duration is less than 1 ms. The electromagnetic signal from the EMP consists of a continuous spectrum with most of the energy centered about a median frequency of 10 to 15 kHz (Ref. 6).

### 10-3 .2.1.8 Electromagnetic Radiation Effects (Ref. 6)

The following is excerpted from Ref. 6:

“For electronic equipment operating within the communications and microwave bands, environmental electromagnetic fields can be harmful in three basic ways: (1) interference, (2) overheating, and (3) electric breakdown. First, the presence of extraneous electromagnetic fields can produce interference, particularly in communication channels, but also in other electronic equipment such as navigation, radar, and command and control units. This interference to a system can be caused by (1) other systems

operating in frequency ranges that interfere with the operation of the desired equipment, and (2) undesired signals generated by the system itself. Good design practice and proper siting of equipment are usually sufficient to eliminate problems encountered in the second category.

“Electromagnetic interference is classified in a number of ways but, for measurement purposes, it is usually classified according to its spectral characteristics. The two general classifications are broadband interference, in which a wide range of frequencies are involved, and narrowband interference, which is centered about a discrete frequency. In addition, the interference is classified with respect to its duration. That which is constant without interruption is called continuous wave or CW interference. Interference that is periodic and occurs in bursts with a regular period is called pulse interference. Pulse interference can be either narrowband or broadband depending upon the pulse duration. In addition, nonrepetitive short duration bursts of broadband noise are called transient interference. Lightning, for example, is a typical example of transient interference. Electromagnetic interference can be coupled into equipment either by direct radiation or by conduction on power lines or structures. [For a thorough discussion of electromagnetic interference and compatibility, see Ref. 21.]

“Through proper frequency management, many interference problems can be reduced. Unfortunately, the problem is complicated because the electromagnetic environment contains not only the desired electromagnetic radiation, but also spurious and undesired interference from both natural and man-made sources. As the number, complexity, and output power of electronic systems in use grow, the problem of the electromagnetic environment and equipment compatibility becomes more serious. For example, within the military, the density of electronic equipment in the field has grown to the point that hundreds of equipments now occupy the same operational environment as did a few equipments in World War 11. It is noted that, in discussing electromagnetic interference, the fields usually spoken of are not high enough to

**DOD-HDBK-791(AM)**

cause permanent damage to the system or equipment under consideration.

“When electromagnetic fields become very large, permanent damage can occur to operating equipment. For example, if the electrical field becomes sufficiently high, electronic breakdown can occur, destroying the equipment. On the other hand, at some intermediate values of field strength, overheating can occur in which the RF field induces currents that contribute to the heat load already present as a consequence of operation of the equipment. This overheating can lead to failure of components and malfunction of the system.

“In addition to the effects of electromagnetic radiation on equipment, another consideration involves the effects of the electromagnetic environment on man and the extent that this must be considered in the design of elec-

tronic materiel. Basically, the effects produced by electromagnetic fields on man are classified into thermal and nonthermal. Some portions of a man’s physiology are particularly susceptible to certain frequencies of electromagnetic energy. One of the prime areas of environmental concern involves the effect of microwaves on human beings.”

**10-3.2.2 Summary of Environmental Effects**

The environmental conditions under which unsheltered equipment should be designed are given in Table 10-10. A summary of the major environmental effects is given in Table 10-11 (Ref. 6), and the failure modes of electronic components due to some of these environmental factors are presented in Table 10-12 (Ref. 22).

**TABLE 10-10. ENVIRONMENTAL REQUIREMENTS FOR UNSHELTERED EQUIPMENT**

Environment	Environmental Limits
Temperature	
Standard Area	
Operating	-29 to 52°C (-20 to 25°F)
Nonoperating	-54 to 54° C (-65 to 30°F)
Cold Weather Area	
Operating	-40°C (-40°F) if operator is unsheltered
Operating	-54°C (-65°F) if operator is sheltered
Nonoperating	-62°C (-80°F) for 3 days and achieve rated capacity after 30 min preheating and warm-up
Desert and Tropical Areas	
Operating	52°C (125°F)
Nonoperating	71°C (160°F) for 4 h per day indefinitely
Humidity	
Operating	Up to 100% at 38°C (100°F) including condensation
Nonoperating	Up to 100% including condensation
Solar Radiation	Endure a solar intensity of 4X10 <sup>6</sup> J/m <sup>2</sup> (360 Btu/ft <sup>2</sup> for a period of 4 h at 52°C (125°F)
Wind	Withstand wind pressures up to 1435 Pa (30 lb/ft <sup>2</sup> ) of projected surface, either empty or under load
Barometer Pressure	
Operating	From 101 to 57 kPa (30 to 16.8 in. of mercury) 4572 m (0-15,000 ft)
Nonoperating	From 101 to 19 kPa (30 to 5.54 in. of mercury) 12,190 m (0-40,000 ft)

TABLE 10-11. SUMMARY OF MAJOR ENVIRONMENTAL EFFECTS (Ref. 6)

Environmental Factor	Principal Effects	Typical Failures Induced
High temperature	Thermal aging: Oxidation Structural change Chemical reaction Softening, melting, and sublimation Viscosity reduction and evaporation Physical expansion	Insulation failure Alteration of electrical properties  Structural failure Loss of lubrication properties Structural failure Increased mechanical stress Increased wear on moving parts
Low temperature	Increased viscosity and solidification Ice formation Embrittlement  Physical contraction	Loss of lubrication properties Alteration of electrical properties Loss of mechanical strength Cracking, fracture Structural failure Increased wear on moving parts
High relative humidity	Moisture absorption  Chemical reaction: Corrosion Electrolysis	Swelling, rupture of container Physical breakdown Loss of electrical strength Loss of mechanical strength Interference with function Loss of electrical properties Increased conductivity of insulators
Low relative humidity	Desiccation: Embrittlement Granulation	Loss of mechanical strength Structural collapse Alteration of electrical properties "Dusting"
High pressure	Compression	Structural collapse Seal penetration Interference with function
Low pressure	Expansion  Outgassing  Reduced dielectric strength of air	Fracture of container Explosive expansion Alteration of electrical properties Loss of mechanical strength Insulation breakdown and arc-over Corona and ozone formation
Solar radiation	Actinic and physicochemical reactions: Embrittlement	Surface deterioration Alteration of electrical properties Discoloration of materials Ozone formation
Sand and dust	Abrasion Clogging	Increased wear Interference with function Alteration of electrical properties
Salt spray	Chemical reactions: Corrosion  Electrolysis	Increased wear Loss of mechanical strength Alteration of electrical properties Interference with function Surface deterioration Structural weakening Increased conductivity

(cont'd on next page)

TABLE 10-11 (cont'd)

Environmental Factor	Principal Effects	Typical Failures Induced
Wind	Force application  Deposition of materials  Heat loss (low velocity) Heat gain (high velocity)	Structural collapse Interference with function Loss of mechanical strength Mechanical interference and clogging Abrasion accelerated Accelerated low-temperature effects Accelerated high-temperature effects
Rain	Physical stress Water absorption and immersion  Erosion  Corrosion	Structural collapse Increase in weight Structural weakening Accelerates cooling Electrical failure Removes protective coatings Structural weakening Surface deterioration Enhances chemical reactions
Water immersion	Corrosion of metals  Chemical deterioration High pressure (13 psi at 30-ft depth)	Structural weakness, seizure of parts, contamination of products Dissolving out and changing of materials Mechanical damage
Insects and bacteria	Penetration into equipment Nibbling by termites	Blockage of small parts, meters, etc. Damage to plastic cables or other organic insulating materials, causing shorts
Fungi	Growth of molds, hyphae	Damage to optical equipment; leakage paths in high impedance circuits; blockage of small parts, meters, etc.; breakdown of mechanical strength of all organic materials
Temperature shock	Mechanical stress	Structural collapse or weakening Seal damage
High-speed particles (nuclear irradiation)	Heating  Transmutation and ionization	Thermal aging Oxidation Alteration of chemical, physical, and electrical properties Production of gases and secondary particles
Ozone	Chemical reactions: Crazing, cracking  Embrittlement Granulation Reduced dielectric strength of air	Rapid oxidation Alteration of chemical, physical, and electrical properties Loss of mechanical strength Interference with function Insulation breakdown and arc-over
Explosive decompression	Severe mechanical stress	Rupture and cracking Structural collapse
Dissociated gases	Chemical reactions:  Contamination Reduced dielectric strength	Alteration of physical and electrical properties  Insulation breakdown and arc-over
Acceleration	Mechanical stress	Structural collapse

(cont'd on next page)

TABLE 10-11 (cont'd)

Environmental Factor	Principal Effects	Typical Failures Induced
Vibration	Mechanical stress	Loss of mechanical strength Interference with function Increased wear Structural collapse
Magnetic fields	Induced magnetization	Interference with function Alteration of electrical properties Induced heating

TABLE 10-12. FAILURE MODES OF ELECTRONIC COMPONENTS (Ref. 22)

Component	Vibration Effects	Shock Effects	Temperature Effects	Humidity Effects	Salt Spray Effects	Storage Effects
Blowers	Brinelling of bearings		Shorts; lubricant deterioration	Corrosion	Corrosion	Lubricant deterioration
Capacitors: ceramic	Increased lead breakage; piezoelectric effect; body and seal breakage	Lead breakage; piezoelectric effect; body and seal breakage	Changes in dielectric constant and capacitance; lowered insulation resistance with high temperature		Corrosion; shorts	Decreased capacitance; silver ion migration
electrolytic	Increased lead breakage; seal damage; current surges	Lead breakage; seal damage; current surges	Increased electrolyte leakage; shortened life; increased current leakage; large change in capacitance; increased series resistance with low temperature	Decreased insulation resistance; increased dielectric breakdown; increase in shorts	Corrosion; shorts	Electrolyte deterioration; shortened life; increased chances for explosion; shorts
mica	Lead breakage	Lead breakage	Increased insulation resistance; silver ion migration; drift	Silver migration	Shorts	Change in capacitance
paper	Increase in opens and shorts; lead breakage	Opens; increased dielectric breakdown; shorts; lead breakage	Changes in capacitance; increased oil leakage; decreased insulation resistance; increased power factor	Decreased insulation resistance; increased power factor	Shorts	Decreased insulation resistance; increased dielectric breakdown; increase in shorts
tantalum	Opens; shorts; current surges; lead breakage	Opens; lead breakage	Electrolyte leakage; change in capacitance; insulation resistance; series resistance	Decreased insulation resistance; increased dielectric breakdown; increase in shorts	Corrosion	Electrolyte leakage; decreased insulation resistance; increase in shorts
Choppers	Increase in phase angle and dwell time	Contacts open; change in phase angle and dwell time	Decrease in phase angle; variation in dwell time		Corrosion	Change in phase angle
Circuit breakers	Premature activation	Premature close or open	Failure to function; premature function	Corrosion	Corrosion	Change in characteristics
Clutches, magnetic	Creep	Intermittent operation	Hot spots in coil	Falloff in torque	Binding	

(cont'd on next page)

TABLE 10-12 (cont'd)

Component	Vibration Effects	Shock Effects	Temperature Effects	Humidity Effects	Salt Spray Effects	Storage Effects
Coils	Loss of sensitivity; detuning; breaking of parts, leads, and connectors	Lead breakage; detuning; loss of sensitivity	Warping, melting; instability; change in dielectric properties	Electrolysis; corrosion	Corrosion; electrolysis	
Connectors: standard	Separation of plugs and receptacles; insert cracks; opening of contacts	Opening of contacts	Flashover, dielectric damage	Shorts; fungus; corrosion of contacts; lowered insulation resistance	Corrosion	Deterioration of seals; corrosion of contacts
interstage	Insert cracks; opening of contacts	Opening of contacts	Flashover, dielectric damage	Shorts; fungus; corrosion of contacts; lowered insulation resistance	Corrosion	Deterioration of seals; corrosion of contacts
Crystals	Opens	Opens	Drift; microphonic	Drift		Drift
Crystal holders	Intermittent contact	Intermittent contact		Change of capacity		
Diodes	Opens	Opens	Change in voltage breakdown; increased current leakage; increase in opens and shorts	Increased current leakage	Corrosion of lead and case	Increased current leakage
Gyros	Drift	Drift; leaks	Drift			Induced drift
Insulators	Cracking; elongation	Cracking	Epoxy cracking; ferrite separation (arcing); moisture condensation (insertion loss)	Moisture condensation (insertion loss); reduction in dielectric strength and insulation resistance	Reduction in dielectric strength and insulation resistance	
Joints, solder	Cracking; opens	Cracking; opens	Loss of strength	Fungus	Corrosion	At room temperature, strength increased; at low temperature, strength decreased
Magnetrons	Arcing; "FM"-ing	Seal breakage		Arcing	Corrosion	Leaks; gassiness
Motors	Brinelling of bearings; loosening of hardware		Shorts; opens; deterioration of lubricants	Binding of bearings; shorting of windings; corrosion	Corrosion binding of bearings	Oxidation

(cont'd on next page)

TABLE 10-12 (cont'd)

Component	Vibration Effects	Shock Effects	Temperature Effects	Humidity Effects	Salt Spray Effects	Storage Effects
Potentiometers	Increased noise; change in torque and linearity; wiper brush bounce; open circuit	Increased noise; change in torque linearity, and resistance; open circuit	Increased noise; change in torque, linearity, and resistance; decreased insulation resistance with high temperature	Increased noise; change in torque, linearity, and resistance; decreased insulation resistance	Decreased insulation resistance; increased corrosion; binding	Increased noise; change in torque, linearity, and resistance; decreased insulation resistance
Relays	Contact chatter	Contact opening or closing	Opens or shorts; decreased insulation resistance with high temperature	Decreased insulation resistance	Corrosion of pins	Oxidation of contacts causes open circuits; decreased insulation resistance
Resistors	Lead breakage; cracking	Cracking; opens	Increased resistance; opens; shorts	Increased resistance; shorts; opens	Change in resistance; corrosion	Change in resistance
Resolvers	Intermittent brush operation; brinelling of bearings; cracking of terminal board; loosening of hardware	Intermittent brush operation; cracking of terminal board; loosening of hardware	High breakaway voltage; shift in electrical axis; opens; shorts; deterioration of lubricants	Corrosion that causes expansion and blistering of potting compound; shorting of winding; pinion corrosion	Corrosion; binding	Oxidation; deterioration of lubricants
Servos	Brinelling of bearings; loosening of hardware; cracking of terminal board	Loosening of hardware; cracking of terminal board	Oil throw-out; breakdown of grease; high breakaway voltage	Corrosion that causes blistering of potting compound; shorting of winding; pinion corrosion	Corrosion that causes rotor binding; salt crystals in bearings and on motor	Deterioration of grease with age; oxidation of brushes and slip rings
Switches	Contact chatter	Contact opening	Oxidation of contacts	Pitted contacts; arcing	Oxidation and pitted contacts	Oxidation of contacts
Synchros	Intermittent brush operation; cracking of terminal board; brinelling of bearings; loosening of hardware	Intermittent brush operation; cracking of terminal board; brinelling of bearings; loosening of hardware	High breakaway voltage	Corrosion that causes expansion and blistering of potting compound; shorting of winding; pinion corrosion	Corrosion	Oxidation
Thermistors	Lead breakage; case cracking; open circuit	Lead breakage; case cracking; open circuit	Increased shorts and opens	Change in resistance	Lead corrosion; change in resistance	Change in resistance

(cont'd on next page)

TABLE 10-12 (cont'd)

Component	Vibration Effects	Shock Effects	Temperature Effects	Humidity Effects	Salt Spray Effects	Storage Effects
Transformers	Shorts; opens; modulation of output	Shorts; opens; modulation of output	Reduced dielectric; opens; shorts; hot spots; malformation	Corrosion; fungus; shorts; opens	Corrosion; shorts; opens	Deterioration of potting and dielectric
Transistors	Opens; functional disintegration	Opens; seal breakage	Increased leakage current; changes in grain; increases in opens and shorts	Increased leakage current; decreased current gain. If sealed, no effect	Increased leakage current; decreased current gain. If sealed, no effect	Seal leakage; changes in parameters
Tubes, electron	Opens; shorts; microphonics; loosening of elements; changes in characteristics	Opens; shorts; changes in characteristics	Shorts; temporary change in characteristics; formation of leakage paths; increased contact potential; shorting of heater life, gassiness; bulb puncture	Change in characteristics; leakage path; arcing	Shorts; corrosion; leakage path; arcing	Change in characteristics; leaks; gassiness
Vibrators	Intermittent	Intermittent	Lag	Case corrosion	Case corrosion	Decrease in frequency

## REFERENCES

1. MIL-STD-1165, *Glossary of Environmental Terms*, 1968.
2. AMCP 706-118, *Engineering Design Handbook, Environmental Series, Part Four, Life Cycle Environments*, 1975.
3. J. Sheldon, "Nondevelopment Item Acquisition", *Army Research, Development and Acquisition Magazine*, p. 9, March-April 1985.
4. AMCP 706-115, *Engineering Design Handbook, Environmental Series, Part One, Basic Environmental Concepts*, 1974.
5. AMCP 706-116, *Engineering Design Handbook, Environmental Series, Part Two, Natural Environmental Factors*, 1975.
6. AMCP 706-117, *Engineering Design Handbook, Environmental Series, Part Three, Induced Environmental Factors*, 1976.
7. MIL-HDBK-759, *Human Factors Engineering Design for Army Materiel*, 1981.
8. HEL STD S-1-63C, *Materiel Design Standard for Noise Levels of Army Materiel Command Equipment*, Human Engineering Laboratory, Aberdeen Proving Ground, MD, 1972.
9. TB MED 501, *Hearing Conservation*, March 1980.
10. TM 11, "Report on Preliminary observations of Human Engineering Problems Under Desert Conditions", Human Engineering Laboratory, Aberdeen Proving Ground, MD.
11. TB MED 507, *Occupational and Environmental Health, Prevention, Treatment, and Control of Heat Injury*, 25 July 1980.
12. ISO DIS 2631, *Guide to the Evaluation of Human Exposure to Whole- Body Vibration*.
13. MIL-HDB-721, *Corrosion and Corrosion Protection of Metals*, 1 1965.
14. MIL-E-5400, *Electronic Equipment, Airborne, General Specifications for*, 1980.
15. MIL-E-16400, *Electronic, Interior Communication and Navigation Equipment, Naval Ship and Shore, General Specifications for*, 1976.
16. TM 20, "Visual Efficiency Under Desert Conditions", Human Engineering Laboratory, Aberdeen Proving Ground. MD.
17. IDA Record Document D-21, *F-16 APG-66 Fire Control Radar Case Study Report*, p. 111-30, August 1983.
18. MIL-HDBK-772, *Military Packaging Engineering*, 30 March 1981.
19. DARCOM-P 706-298, *Engineering Design Handbook, Rocket and Missile Container Engineering Guide*, January 1982.
20. TM 38-230-1, *Packaging of Materiel: Preservation (Vol. 1)*, 1 August 1982.
21. DARCOM-P 706-410. *Engineering Design Handbook, Electromagnetic Compatibility (EMC)*, March 1977.
22. Space, *Aeronautics*. 36, No. 6, December 1961.

## GLOSSARY

### A

**Accessibility.** A design feature that affects the ease of admission to an area for the performance of visual and manipulative maintenance.

**Active maintenance time.** The time during which preventive and/or corrective maintenance work is being done on the item.

**Active repair time.** The time during which one or more technicians are working on the item to effect a repair.

**Active technician time.** That time (expressed in man-hours) expended by the technician(s) in active performance of a maintenance task.

**Adjustment and calibration time.** That element of active maintenance time required to make the adjustments and/or calibrations necessary to place the item in a specified condition.

**Administrative time.** The downtime due to nonavailability of test equipment or maintenance facilities and the time due to nonavailability of maintenance technicians caused by administrative functions. It is that portion of nonactive maintenance time that is not included in logistic time.

**Alignment.** Performing the adjustments that are necessary to return an item to a specified level of operation.

**Artificial intelligence (AI).** A field aimed at pursuing the possibility that a computer can be made to behave in a manner that humans recognize as intelligent behavior in each other.

**Automatic test equipment (ATE).** Equipment designed to conduct automatically the analysis of functional or static parameters and to evaluate the degree of the performance degradation of the unit under test. The test equipment is not an integral part of the unit under test.

**Automatic testing.** The process by which the localization of faults, possible prediction of failure, or validation that the equipment is operating satisfactorily is determined by a device that is programmed to perform a series of self-sequencing test measurements without the necessity of human direction after its operations have been initiated.

**Availability.** A measure of the degree to which an item is in operable and committable state at the start of the mission, when the mission is called for at an unknown (random) point in time.

**Availability (achieved).** The percentage of time the system is operating when considering only operating time and total maintenance (scheduled and unscheduled) time. The equation is

$$A_a = \frac{OT}{OT + TCM + TPM}$$

where

*OTC* = operating time during a given calendar time period

*TCM* = total corrective (unscheduled) maintenance downtime during a given calendar time period

*TPM* = total preventive (scheduled) maintenance downtime during a given calendar time period

*A<sub>a</sub>* = achieved availability.

**Availability (inherent).** The percentage of time the system is operating when considering only operational time and unscheduled (corrective) maintenance time. The equation is

$$A_i = \frac{OT}{OT + TCM}$$

where

*OT* = operating time during a given calendar time period

*TCM* = total corrective (unscheduled) maintenance downtime during a given calendar time period

*A<sub>i</sub>* = inherent availability.

**Availability (operational).** A measure of the degree to which an item is either operating or is capable of operating at any random point in time when used in a typical maintenance and supply environment. The equation is

$$A_o = \frac{OT + ST}{OT + ST + TCM + TPM + TALDT}$$

where

*OT* = operating time during a given calendar time period

## DOD-HDBK-791(AM)

$ST$  = standby time (not operating, but assumed operable) during a given calendar time period

$TCM$  = total corrective (unscheduled) maintenance downtime during a given calendar time period

$TPM$  = total preventive (scheduled) maintenance downtime during a given calendar time period

$TALDT$  = total administrative and logistic downtime spent waiting for parts, maintenance personnel, or transportation during a given calendar time period

$A_o$  = operational availability.

### B

**Best operating capability (BOC).** The upper level maintainability value estimated to be technically feasible within the stated time frame and within reasonable cost constraints.

**Built-in test (BIT).** An integral capability of the mission equipment that provides an on-board, automated test capability to detect, diagnose, or isolate system failures. The fault detection and, possibly, isolation capability are used for periodic or continuous monitoring of the operating condition of a system, and for observation and diagnosis as a prelude to maintenance. BITE may be automatically or manually triggered.

**Built-in test equipment (BITE).** Any device which is part of an equipment or system and is used for the express purpose of testing the equipment or system. It is an identifiable unit of the equipment or system. BITE may be automatically or manually triggered.

### C

**Calendar time.** The total number of calendar days or hours in a designated period of observation.

**Calibration.** Those measurement services provided by designated depot and/or laboratory facility teams, who by the comparison of two instruments one of which is a certified standard of known accuracy detect and adjust any discrepancy in the accuracy of the instrument being compared with the certified standard.

**Cannibalization.** The removal of serviceable items from a piece of equipment to repair another.

**Capability.** A measure of the ability of an item to achieve mission objectives given that the item performs as specified throughout the mission.

**Catastrophic failure.** A sudden change in the operating

characteristics of some part or parameter resulting in a complete failure of the item, e.g., circuit opens or shorts, structural failure. etc.

**Chargeable.** Within the responsibility of a given organizational entity (such as Failures, Maintenance time. etc.)

**Checkout.** A man machine task to determine that the equipment is operating satisfactorily and is ready for return to service.

**Checkout time.** The time required to check out the equipment after a maintenance action or otherwise to verify that a system or equipment is in satisfactory operating condition.

**Circuit malfunction analysis.** The logical, systematic examination of circuits and their diagrams to identify and analyze the probability and consequence of potential malfunctions for determining related maintenance or maintainability design requirements.

**Conceptual phase.** The first phase in the material life cycle. The phase in which the technical, military, and economic basis for the program. and concept feasibility are established through pertinent studies.

**Configuration control.** The systematic evaluation, coordination, approval or disapproval, and implementation of all approved changes in the configuration of a configuration item after formal establishment of its configuration identification.

**Configuration item.** An aggregation of hardware software. or any of its discrete portions, which satisfies an end use function and is designated by the Government for configuration management. Configuration items may vary widely in complexity, size, and type, from an aircraft, an electronic or ship system to a test meter or round of ammunition. During development and initial production. configuration items are only those specification items that are referenced directly in a contract (or an equivalent in-house agreement). During the deployment phase, any repairable item designated for separate procurement is a configuration item.

**Contract data requirements list (CDRL).** A listing of all technical data and information required to be delivered to the Government by the contractor.

**Corrective maintenance.** That maintenance performed to restore an item to a satisfactory condition by providing correction of a malfunction that has caused degradation of the item below the specified performance.

**Corrective maintenance time.** The time that begins with the observance of a malfunction of an item and ends when the item is restored to a satisfactory operating condition. It may be subdivided into active maintenance time and nonactive maintenance time. It does not

necessarily contribute to equipment or system downtime in cases of alternate modes of operation or redundancy.

**Criticality.** A measure of the impact of the failure mode of the item that includes the severity of the effect combined with the frequency or probability of occurrence.

## D

**Delay time.** The component of downtime during which no maintenance is being accomplished on the item because of technician alert and response time, supply delay, or administrative reasons.

**Demonstrated.** That which has been measured, within specified confidence limits, by the use of objective evidence gathered under specified conditions.

**Dependability.** A measure of the degree to which an item is operable and capable of performing its required function at any (random) time during a specified mission profile, given item Availability at the start of the mission. (Item state during a mission includes the combined effects of the mission-related system R & M parameters but excludes nonmission time: *see* AVAILABILITY.)

**Depot maintenance.** A category of maintenance organized to support the supply system. It will be production-line oriented and will be performed by special repair activities, US Army Materiel Command (AMC) depots, and contractor personnel.

**Design adequacy.** The probability that a system or equipment will successfully accomplish its mission, given that the system is operating within design specifications.

**Design review.** A multipurpose design verification procedure and project management tool used to evaluate the cumulative results of all constituent design verification cycles at each of several designated major milestones in the acquisition process in order to provide adequate engineering basis for timely iteration in the total system engineering cycle.

**Development model.** A model designed to meet performance requirements of the specification or to establish technical requirements for production equipment. This model need not have the required final form or necessarily contain parts of final design. It may be used to demonstrate the reproducibility of the equipment.

**Development testing.** A series of materiel tests conducted

by the Army developer—with or without contractor assistance—to assess program technical risks, demonstrate that engineering design is complete and acceptable, determine the extent of the design risks, determine specification compliance, and assess production requirements.

**Diagnostics.** The functions performed and the techniques used in determining and isolating the cause of malfunctions in an operating system or determining its operational status.

**Direct maintenance man-hours per maintenance action (DMMH/MA).** A measure of the maintainability parameter related to item demand for maintenance manpower. The sum of direct maintenance man-hours at all levels or repair, divided by the total number of maintenance actions (preventive and corrective) during a stated period of time.

**Direct maintenance resources.** The time in man-hours and material in dollars expended directly on the item being maintained during the period of active maintenance.

**Disassemble.** Opening an item and removing a number of parts of subassemblies to make the item that is to be replaced accessible for removal. This does not include the actual removal of the item to be replaced.

**Discard-at-failure maintenance.** Maintenance accomplished by replacing and discarding a failed assembly, subassembly, module, or piece part. The term normally is associated with modules.

**Downtime.** That portion of calendar time when the item cannot perform its intended function.

## E

**Ease of maintenance.** The degree of facility with which equipment can be retained in, or restored to, operation. It is a function of the rapidity with which maintenance operations can be performed to avert malfunctions or correct them if they occur. Ease of maintenance is enhanced by any consideration that will reduce the time and effort necessary to maintain equipment at peak operating efficiency.

**Engineering change proposal (ECP).** A proposal to change the design or engineering features of materiel undergoing development or production.

**Environment.** The aggregate of all external and internal conditions—such as temperature, humidity, radiation, magnetic and electric fields, shock, and vibration—either natural or man-made or self-induced that influ-

## DOD-HDBK-791(AM)

ences the form, performance, reliability or survival of an item.

**Equipment repair time.** The 50th percentile, i.e., the median, of the distribution of repair time.

**Expert system.** An intelligent computer system that uses knowledge and inference procedures to solve problems that are difficult enough to require significant human expertise in their solution.

## F

**Failure.** A detected cessation of ability to perform a specified function or functions, within previously established limits, in the area of interest. It is a malfunction that is beyond adjustment by the operator by means of controls normally accessible to him during the routine operation of the device.

**Failure analysis.** The logical, systematic examination of an item to identify and diagnose the cause of observed failures.

**Failure effect.** The condition(s) introduced by a failure that reduce or modify the ability of an item to perform its required function.

Failure mode, effects, and criticality analysis (FMECA). A general evaluation procedure that

1. Documents all possible potential failures in an item design
2. Determines by analysis the effect of each potential failure on item operation and on each reliability and maintainability parameter applicable to the type of item
3. Ranks potential failures according to their impact (see CRITICALITY) on each applicable system reliability and maintainability parameter.

**Failure rate.** The number of failures of an item per unit measure of use—cycles, time, miles, events, etc., as applicable. It is also called renewal rate.

**Fault correction time.** That element of active repair time required under a specified maintenance philosophy to correct the malfunction. It may consist of correcting the malfunction with the faulty item in place, removing and replacing the item with a like serviceable item, or removing the item for corrective maintenance and reinstalling the same item.

**Fault detection time.** Time between the occurrence of a failure and the point at which it is recognized that the system or equipment does not respond to operational demand during the mission sequence.

**Fault location time.** That element of active repair time

required for testing and analyzing an item to isolate a malfunction.

**Field maintenance.** Maintenance authorized and performed by designated maintenance activities in support of using organizations.

**Final test time.** That element of active repair time required after completion of maintenance, adjustments, and calibration to verify by measurement of performance that the item is in a condition to perform its function satisfactorily.

**Free time.** Time during which operational use of a system or equipment is not required; this time may or may not be downtime, depending on whether or not the system is in operable condition.

**Frequency-of-use-principle (equipment design).** The principle of positioning the most frequently maintained items in preferred locations to facilitate maintenance.

**Full-scale development phase.** The third phase in the materiel acquisition process. During this phase, a system—including all items necessary for its support—is fully developed and engineered, fabricated, tested, and initially type classified. Concurrently, nonmaterial aspects required to field an integrated system are refined and finalized.

**Function analysis for maintainability.** The analytical basis for allocating tasks to personnel and equipment so as to achieve optimum system maintainability.

**Functional interchangeability.** A condition in which a part or unit, regardless of its physical specifications, can perform the specific functions of another part or unit.

**Functional principle (equipment design).** The principle of arrangement that provides for the grouping of hardware items according to their functions.

## G

**General-purpose test equipment.** A category of test equipment, normally available in the supply system or from commercial stock, that can be used to test more than one system or equipment type.

**Geometric mean-time-to-repair (MTTRG).** A measure of central tendency for repair time. Generally used with the lognormal distribution.

**Go/no-go display.** A display that indicates the operable or nonoperable condition of equipment.

## H

**Human engineering.** The area of human factors that applies scientific knowledge to the design of items to achieve effective operation, maintenance, and man/machine integration.

**Human factors.** Human characteristics relative to complex systems and the development and application of principles and procedures for accomplishing optimum man/machine integration and utilization. The term is used in a broad sense to cover all biomedical and psychosocial considerations pertaining to man in the system.

## I

**Inactive time.** The period of time when the item is available, but it is neither needed nor operated for its intended use.

**Indirect maintenance resources.** That time in man-hours and material in dollars which, although not directly expended in active maintenance tasks, contributes to the overall maintenance mission through the support of overhead operations, administration, accumulation of facility records and statistics, supervision, and facilities upkeep.

**Inherent value.** A measure of maintainability which includes only the effects of item design and application and assumes an ideal operation and support environment.

**In-process review (IPR) (nonmajor hardware systems).** A review conducted at critical points in the acquisition process to evaluate military utility, accomplish effective coordination, and facilitate proper and timely decisions.

**Interchangeability.** A condition when two or more parts are physically and functionally interchangeable in all possible applications, i.e., when both parts are capable of full, mutual substitution in all directions.

**Intermediate maintenance.** A category of maintenance organized as forward and rear. Forward maintenance is characterized by high mobility and repair by replacement, Division maintenance units will support maneuver elements, and nondivisional units will provide area and backup support to the division. Rear intermediate maintenance is characterized by semifixed facilities. Its fundamental purpose is to support the theater supply system through repair of components and direct exchange of items.

**Item.** A nonspecific term used to denote any product, including systems, materials, parts, subassemblies, sets, accessories, etc.

**Item obtainment time.** The time required for the technician to obtain replacement parts, assemblies, or units, depending on the maintenance concept and the location and method of storing the supply items.

## L

**Life cycle costs.** The sum of the funds expended during the life cycle of materiel for development, test, procurement, operation, support, and disposal.

**Line-replaceable unit (LRU).** An item whose removal and replacement with a like serviceable item is considered the optimum corrective method for a specific higher indenture level item.

**Logistic resources.** The support personnel and materiel required by an item to assure its mission performance. It includes such things as tools, test equipment, repair parts, facilities, technical manuals, and administrative and supply procedures necessary to assure the availability of these resources when needed.

**Logistic support.** Maintenance and supply support to be provided at unit and intermediate and depot levels. Logistic support is influenced by the degree of unitization or modularization, ruggedness, cost, test points, test equipment, tactical employment, and transportation requirements.

**Logistic time.** The portion of downtime attributable to delay in the acquisition of replacement parts.

**Logistics.** Those aspects of military operations which deal with (a) design and development, acquisition, storage, movement, distribution, maintenance, evacuation, and disposal of materiel, (b) movement, evacuation, and hospitalization of personnel, (c) acquisition or construction, maintenance, operation and disposition of facilities, and (d) acquisition or furnishing of services.

## M

**Maintainability.** A measure of the ease and rapidity with which a system or equipment can be restored to operational status following a failure or retained in a specified condition. It is characteristic of equipment design and installation, personnel availability in the required skill levels, adequacy of maintenance procedures and test equipment, and the physical environment under which maintenance is performed. One expression of maintainability is the probability that an item will be retained in or restored to a specified condition within a given period of time when the maintenance is performed in accordance with prescribed procedures and resources.

## DOD-HDBK-791(AM)

**Maintainability analysis.** The definition of maintainability design procedures and evaluation of achievement of maintainability design goals through use of prediction, verification, demonstration and assessment techniques to insure that system or equipment design characteristics meet operational objectives with a minimum expenditure of maintenance and support effort.

**Maintainability data.** Data (other than administrative data) resulting from performance of maintainability tasks in direct support of an equipment or system acquisition program.

**Maintainability demonstration tests.** Tests, usually at the equipment or subsystem level, for the major items that will comprise the integrated system to demonstrate conformance with specified quantitative maintainability requirements.

**Maintainability constraints.** A group of factors—environmental, human, hardware—which establishes limits to the performance of maintenance on an item.

**Maintainability program.** The planning, development, and implementation of those organized sets of tasks directly related to the specification, prediction, verification and assessment of the design characteristics of an item with the goal of meeting operational objectives with a minimum expenditure of maintenance and support effort.

**Maintainability requirement.** A comprehensive statement of required maintenance characteristics, expressed in qualitative and quantitative terms, to be satisfied by the design of an item.

**Maintenance.** All actions necessary for retaining an item in, or restoring it to, a serviceable condition. Maintenance includes servicing, repair, modification, overhaul, inspection, and condition determination.

**Maintenance ability.** A figure of merit for a crew of a using organization defined as the ratio of maintenance man-hours established on a specific item by a trained and expert maintenance crew to the maintenance man-hour figure established by the crew of the using organization on the same item and under similar maintenance conditions.

**Maintenance analysis.** The process of identifying required maintenance functions through analysis of a fixed or assumed design and determining the most effective means of accomplishing these functions.

**Maintenance category.** Division of maintenance of materiel, based on difficulty and requisite technical skill, in which jobs are allocated to organizations in accordance with the availability of personnel, tools, supplies, and time within the organization.

Maintenance concept. A description of the general scheme

for maintenance and support of an item in the operational environment.

**Maintenance element.** A discrete portion of a maintenance task which can be described or measured.

**Maintenance engineering.** The application of techniques, engineering skills, and effort during the life cycle of materiel to insure the planning and implementation of an effective maintenance program.

**Maintenance error.** An error on the part of maintenance personnel in performing maintenance on an item which results in subsequent failure or malfunction, or an error in published maintenance procedures which results in subsequent failure or malfunction. (Note: Items removed because of maintenance errors are considered Unscheduled Removals.)

**Maintenance functions.** Actions that must be accomplished for a system or system element to return a failed system element to readiness (corrective maintenance functions) or to insure continuing normal system readiness (preventive maintenance functions).

**Maintenance level.** One of several organizational entities to which materiel maintenance functions may be assigned. The maintenance levels are unit, intermediate, and depot.

**Maintenance man-hours.** The number of active maintenance man-hours—total number of maintenance personnel required multiplied by number of hours worked to perform a maintenance operation.

**Maintenance plan.** A part of the plan for logistic support. The maintenance plan contains conditions of materiel use, reliability and maintainability requirements, the maintenance concept, a definition of the using and support organizations, maintenance test and physical teardown information, and a maintenance allocation chart.

**Maintenance procedures.** Established methods for periodic checking and servicing items to prevent failure or to effect a repair.

**Maintenance proficiency.** The ability of maintenance personnel to apply job skills in the maintenance of an item.

**Maintenance resources.** Facilities; ground support equipment; test, measurement, and diagnostic equipment (TMDE); manpower; repair parts; consumables; and funds available to maintain and support an item in its operational environment.

**Manpower and personnel integration (MANPRINT).** A program whose purpose is to impose human factors, manpower, personnel, training, system safety, and health hazard considerations across the entire materiel acquisition process.

**Maintenance task.** Any action or actions required to preclude the occurrence of a malfunction or to restore an equipment to satisfactory operating condition.

**Malfunction.** A general term used to denote the failure of a product to give satisfactory performance. It need not constitute a failure if readjustment of operator controls can restore an acceptable operating condition.

**Maximum time to repair ( $M_{max_r}$ ).** The maximum time required to complete a specified percentage of all maintenance actions.

**Mean.** A quantity representing the average of two or more other quantities arrived at by adding the quantities together and dividing by their number. Also called "arithmetic mean". The "geometric mean" of two quantities is the square root of the product of the quantities.

**Mean maintenance time.** The mean time required to complete a maintenance action, i.e., total maintenance downtime divided by the total maintenance actions.

**Mean time between downtime events (MTBDE).** A measure of the system reliability parameter related to availability and readiness. The total number of system life units, divided by the total number of events in which the system becomes unavailable to initiate its mission(s), during a stated period of time.

**Mean time between failures (MTBF).** The total functioning life of a population of an item divided by the total number of failures within the population during the measurement interval. The definition holds for time, cycles, miles, events, or other measures of life units.

**Mean-time-to-correct-failure.** The expected value of the time required to restore an equipment or system to a condition of satisfactory operation, measured from the moment it is judged unsatisfactory for normal use.

**Mean task time.** A representative task time equal to the summation of task times required to perform a specific task a number of different times divided by the number of times performed.

**Mean-time-to-repair (MTTR).** The statistical mean of the distribution of times-to-repair. The summation of active repair times during a given period of time divided by the total number of malfunctions during the same time interval.

**Mean-time-to-restore-system (MTTRS).** A measure of the system maintainability parameter related to availability and readiness. The total corrective maintenance time, divided by the total number of downing events, during a stated period of time. (Excludes time for off-system maintenance and repair of detached components.)

**Median corrective maintenance time ( $\tilde{M}_{ct}$ ).** The downtime within which 50% of all corrective maintenance actions can be completed under the specified maintenance conditions. (Also called Equipment Repair Time (ERT).)

**Median preventive maintenance time ( $\tilde{M}_{pt}$ ).** The equipment downtime required to perform 50% of all scheduled preventive maintenance actions on the equipment under the specified conditions.

**Military standard.** A document that establishes engineering and technical requirements for items, equipments, processes, procedures, practices, and methods that have been adopted as standard.

**Military specification.** A document intended primarily for use in procurement, which clearly and accurately describes the essential technical requirements for items, materials, or services, including the procedures by which it will be determined that the requirements have been met. Specifications for items and materials may also contain preservation-packaging, packing, and marking requirements.

**Minimum acceptable value (MA V).** A minimum value consistent with system operation and support concepts.

**Mission reliability.** The probability that, under stated conditions, a system or equipment will operate in the mode for which it was designed, i.e., with no malfunctions, for the duration of a mission, given that it was operating in this mode at the beginning of the mission.

**Mission time.** The period of time in which an item must perform a specified mission.

**Model.** Any device, technique, or process with which the specific relationships of a set of quantifiable system parameters may be investigated.

**Modification.** A major or minor change in the design of an item of materiel, performed to correct a deficiency, to facilitate production, or to improve operational effectiveness.

**Modularization.** The design of equipment such that its functional grouping, arrangement and size and parts and/or assemblies improve both the ability to test and ease of maintenance.

**Module.** A part, subassembly, assembly, or component designed to be handled as a single unit to facilitate supply and installation, operations, and/ or maintenance.

## N

**National inventory control point (NICP).** An organizational segment, within the overall supply system of a commodity command, to which has been assigned

## DOD-HDBK-791(AM)

responsibility for integrated material inventory management of a group of items.

### O

**Operating and support phase.** The period in the system life cycle which starts with the delivery of the first item of equipment to the using unit and terminates with disposition of the system from the inventory.

**Operational readiness.** The probability that, at any point in time, a system or equipment is either operating satisfactorily or ready to be placed in operation on demand when used under stated conditions, including stated allowable warning time. Thus, total calendar time is the basis for computation of operational readiness.

**Operational testing.** A series of tests conducted by the designated user to determine operational effectiveness, suitability, and military desirability of materiel and the adequacy of the organization, doctrine, and tactics proposed for use.

**Operational value.** A measure of maintainability which includes the combined effects of item design, quality, installation, environment, operation, maintenance, and and repair.

**Operating time.** The time during which a system or equipment is operating in a manner acceptable to the operator, although unsatisfactory operation (or failure) is sometimes the result of the judgment of the maintenance technician.

**Overhaul** To restore an item to a completely serviceable condition as prescribed by maintenance serviceability standards.

### P

**Periodic maintenance.** Maintenance performed on equipment on the basis of hours of operation or calendar time elapsed since last inspection.

**Physical interchangeability.** A condition in which any two or more parts or units made to the same specification can be mounted, connected, and used effectively in the same position in an assembly or system.

**Plan for logistic support.** A major section of the materiel acquisition plan that deals with all aspects of materiel support planning.

**Preparation time.** That element of active repair time required to obtain necessary test equipment and maintenance manuals and to setup the necessary equipment in preparation for fault location.

**Preventive maintenance.** That maintenance performed to retain an item in satisfactory operational condition by providing systematic inspection, detection, and prevention of incipient failures.

**Preventive maintenance time.** That portion of calendar time used in accomplishing preventive maintenance. It comprises time spent in performance measurement; care of mechanical wear-out items; front panel adjustment, calibration, and alignment; cleaning; and scheduled replacement of items.

**Probability of fault detection.** By using authorized displays, manuals, checklists, test points, and test equipment, the probability that an existing fault—which would render a system or equipment inoperable (or marginally effective) will be detected.

**Production model.** An item in its final mechanical and electrical form—of final production design made by production tools, jigs, fixtures, and methods.

**Production and deployment phase.** The fourth phase in the materiel life cycle. During this phase, all hardware, software, and trained personnel required to deploy an operational system are acquired.

**Proportion of faults isolatable.** Given that a fault has occurred which renders a system or equipment inoperable, the percentage of the faults that can be traced to an isolatable unit by using authorized displays, manuals, checklists, test points, and test equipment.

**Prototype model.** A model suitable for complete evaluation of mechanical and electrical form, design, and performance. It is in final mechanical and electrical form, uses approved parts, and is completely representative of final equipment.

### Q

**Qualitative maintainability requirement.** A maintainability requirement expressed in qualitative terms—e.g., minimize complexity, design for a minimum number of tools and items of test equipment, and design for optimum accessibility.

**Quantitative maintainability requirement.** A maintainability requirement expressed in quantitative terms i.e., a figure of merit in measurable units of time or resources required to accomplish a specific maintenance task or group of tasks in relation to the applicable performance requirements (reaction time, availabilities, downtime, repair time, turnaround time, etc.)

### R

**Random failure.** Any Failure whose exact time of occurrence cannot be predicted.

## S

**Reaction time.** The time required to initiate a mission; measured from the time the command is received.

**Ready time.** The period of time during a mission that the item is available for operation but is not required.

**Reassembly.** A technician task for replacement of items removed to gain access to facilitate repair and for closing the equipment for return to service.

**Rebuild.** To restore to a condition comparable to new by disassembling the item to determine the condition of each of its component parts, and reassembling it using serviceable, rebuilt, or new assemblies, subassemblies, and parts.

**Redundancy.** The existence of more than one means for accomplishing a given task, where some number of means must fail before there is an overall failure to the system. Parallel redundancy applies to systems where both means are working at the same time to accomplish the task and either of the systems is capable of handling the job itself in case of failure of the other system. Series or standby redundancy applies to a system where there is an alternate means of accomplishing the task, i.e., the standby redundancy is switched in by a malfunction sensing device when the primary system fails.

**Reliability.** The probability that an item will perform its intended function for a specified interval under stated conditions.

**Reliability centered maintenance (RCM).** A concept that uses decision logic to evaluate and construct maintenance tasks which are based on the equipment functions and failure modes.

**Repair.** The process of returning an item to a specified condition including preparation, fault location, item procurement, fault correction, adjustment and calibration, and final test.

**Repairability.** The capability of an item to be repaired.

**Repairable item.** An item which can be restored to perform all of its required functions by corrective maintenance.

**Repair rate.** A measure of repair capability, i.e., the number of repair actions completed per unit of time.

**Repair time.** See active repair time.

**Replacement schedule.** The specified periods when items of operating equipment are to be replaced. Replacement means removal of items approaching the end of their maximum useful life, or the time interval specified for item overhaul or rework, and installation of a serviceable item in its place.

**Replacing.** Substituting one unit for another unit. Usually done to substitute a properly functioning unit for a malfunctioning unit.

**Self test.** A test or series of tests, performed by a device upon itself, that shows whether or not the device is operating within designed limits. This includes test programs on computers and automatic test equipment that check out their performance status and readiness.

**Serviceability.** The design, configuration, and installation features that will minimize periodic or preventive maintenance requirements, including the use of special tools, support equipment, skills, and manpower, and enhance the ease of performance of such maintenance, including inspection and servicing.

**Service life.** The period of time during which an item can remain in the operational inventory under specified conditions of use and maintenance.

**Servicing.** The performance of any act—other than preventive or corrective maintenance—required to keep an item of equipment in operating condition, such as lubricating, fueling, oiling, cleaning, etc. This does not include periodic replacement of parts or any corrective maintenance tasks.

**Skill level.** Level of proficiency required for performance of a specific job, and the level of proficiency at which an individual qualifies in that occupational specialty.

**Sneak circuit.** An unexpected path or logic flow within a system which, under certain conditions, can initiate an undesired function or can inhibit a desired function.

**Software.** That portion of the support subsystem required in addition to personnel and hardware. Software includes technical data, computer programs and tapes, training documents, etc.

**Special tools.** Tools peculiar to a specific end product.

**Standardization.** The use of common items, parts, materials, and practices throughout the life cycle of systems and equipment.

**Storage time.** Time during which a system or equipment is presumed to be in operable condition but is being held for subsequent use.

**Support cost.** The total cost of ownership, excluding operating crews and using personnel, of an item during its operational life including the total impact of requirements for skill levels; technical data; test, measurement, and diagnostic equipment (TMDE); spares; repair parts; special tools; maintenance equipment; facilities; levels and location of maintenance facilities; manpower; and training and training equipment.

**Supportability.** A measure of the capability of materiel to be supported easily and economically.

## DOD-HDBK-791(AM)

**Support equipment.** Items necessary for the maintenance or operation of the system which are not physically part of the system.

**Support parameter.** Any of the several categories of support resources—such as personnel, repair parts, and facilities—required to support materiel.

**System effectiveness.** The probability that a system can meet successfully an operational demand within a given time when operated under specified conditions.

**System engineering.** The application of scientific and engineering knowledge to the planning, design, construction, and evaluation of man/machine systems and components. It includes the overall consideration of possible methods for accomplishing a desired result, determination of technical specification, identification and solution of interfaces among parts of the system, development of coordinated test programs, assessment of data, integrated logistic support planning, and supervision of design work.

### T

**Testability.** A design characteristic that allows the status of a unit or system to be determined in a timely and cost-effective manner.

**Testability analysis.** An element in equipment design analysis effort related to developing a diagnostic approach and then implementing that approach.

**Test and checkout level.** The functional level at which equipment status is verified.

**Test, measurement, and diagnostic equipment (TMDE).** Any system or device used to evaluate the operational condition of materiel to identify and/or isolate any actual or potential malfunction.

**Test point.** A convenient and safe access to functional portions of materiel that is to be used so that a significant quantity can be measured or an access introduced to facilitate maintenance, repair, calibration, alignment, or monitoring.

**Total downtime.** That portion of calendar time during which a system is not in condition to perform its intended function. It includes active maintenance (preventive and corrective), supply downtime due to unavailability of needed items, and waiting and administrative time.

**Total technician time.** The total man-hour expenditure required to complete a maintenance task. It includes active technician time and delay technician time.

**Trade-off.** A comparison of two or more ways of doing something in order to make a decision. Decision criteria normally are quantitative.

**Troubleshooting.** Locating and diagnosing malfunctions or breakdowns in equipment by means of systematic checking or analysis:

### U

**Unitization.** The process of providing a series of plug-in units or similar subassemblies, each of which contains all parts necessary to make up a complete functioning circuit or stage. Each circuit or stage can be independently removed and replaced with a like unit or subassembly. See also module.

**Unit maintenance.** A category of maintenance which is categorized by quick turnaround based on repair by replacement and minor repair -e. g., adjust, clean, lubricate, tighten. The maintenance is performed by the operator, crew, and company or battalion maintenance personnel.

**Unscheduled maintenance.** All maintenance work not specifically planned to occur at a prearranged time.

**Useful life.** The total operating time in which an item remains operationally effective and economically useful before wear-out.

### V

**Validation phase.** The second phase in the materiel acquisition process. This phase consists of those steps necessary to resolve or minimize special logistic problems identified during the conceptual phase. verify preliminary design and engineering, accomplish necessary planning, fully analyze trade-off proposals, and prepare contracts as required for full-scale development.

**Value engineering (VE).** An organized effort directed at analyzing the function of an item with the purpose of achieving the function at the lowest overall cost.

### W

**Wear-out.** The point at which further operation is uneconomical.

**Wear-out failure.** A failure that occurs as a result of deterioration or mechanical wear and whose probability of occurrence increases with time. Wear-out failures generally occur near the end of the life of an item and are usually characterized by chemical or mechanical changes. These failures frequently can be prevented by adopting an appropriate replacement policy based on the known wear-out characteristics of the item.

## INDEX

## A

Abbreviations, use in labeling, 6-8  
 Absorber, shock, 4-27  
 Access, 4-1, 4-2, 4-7. *See also* Accessibility  
   aircraft, 4-24, 4-25  
   criteria for, 4-2  
   covers, 4-3  
   doors, 4-3  
   electronic equipment, 4-10  
   fire control equipment, 4-20  
   for lubrication, 8-10  
   for maintenance actions, 4-2,4-40  
   for reciprocating engine accessories, 4-25,4-26,4-27  
   location of, 4-6  
     component arrangement and mounting, 4-6, 4-7  
     importance of, 4-6  
     to avoid dangerous situations, 4-6  
   marine equipment, 4-24  
   missiles, 4-20  
   modules, use of, 5-1  
   openings, size and shape, 4-5, 4-10, 4-12, 4-13, 4-15, 4-26  
     for gloved hand, 4-15,4-25,4-26  
     one handed, 4-12  
   physical access for visual inspection, test, and service equipment, 4-4  
   tank and automotive, 4-22  
   trailers, 4-20, 4-21  
   types, 4-3  
   visual inspection, light intensity required, 4-3  
   windows, 4-3  
     materials, 4-5  
 Accessibility, 1-7, 4-1, 4-2. *See also* Access  
   checklist, 4-28, 4-29  
   factors affecting, 4-2  
   planning for, 4-2  
   safety considerations, 4-1  
 Accident, aviation, due to human error, 9-14  
 Active maintenance time, 1-2  
 Adaption kits, 4-2, 5-9  
 Advanced Attack Helicopter (AAH), 5-6  
   artificial intelligence application, 7-10  
 Aircraft materiel, 4-24  
   access to equipment, 4-25  
   Advanced Attack Helicopter (AAH), 5-6  
   Helicopter UH-60A, BLACK HAWK, 2-4  
   landing gear, 4-27  
   propulsion systems, 4-25  
 Aligning, 4-20, 8-16  
 Aluminum, attack by alkaline solutions, 8-15  
 Ammunition supply, 3-6  
 Analysis, module postmortem, 5-3  
 Anchors, 4-22

Anthropometric data, 4-1,4- 10,9-1,9-2,9-3  
   sources, 9-2  
     MIL-HDBK-759, 9-2  
     MIL-STD-1472, 9-2  
 Antifouling paint, 4-24  
 AR 702-3, *Army Materiel, System Reliability, Availability, and Maintainability (RAM)*, 1-7  
 Armament, modular design, 5-9  
 Army Maintenance Management System (TAMMS), 9-15  
 Army Master Data File, 3-6, 3-8  
 Army Test Program Sets (TPS), 3-10  
 ATE. *See* Automatic test equipment  
 Auditory system, 9-11  
 Automatic test equipment (ATE), 5-4, 7-2, 7-8  
   artificial intelligence, use of, 7-9  
   block diagrams, use of, 7-8  
   cost, 7-8  
   definition, 7-8  
   EQUATE, 7-9  
   GENRAD, 7-9  
   logic flow technique, use of, 7-8  
   output format, 7-16  
   sneak circuits in, 7-11  
   stimuli, 7-10, 7-16  
     transducers (sensors) selection characteristics, 7-16  
   test features for consideration, 7-8  
   test point compatibility, 7-12  
   versus built-in test equipment (BITE) 7-11  
 Automotive replacement parts, frequency of occurrence, 4-23,4-24  
 Availability, 1-1,4-1, 8-3

## B

Bacteria, 10-2, 10-20  
 Batteries, 10-14, 10-15  
 Bearings, 4-28  
   lubrication, 4-28, 8-7  
   split, 4-28  
 BITE. *See* Built-in test equipment  
 BLACK HAWK Helicopter, UH-60A, 2-4, 7-7  
   example of decrease in mean time to repair by use of standard/ interchangeable parts, 3-5  
 Blind mountings, 4-5,4-6,4-10, 8-8  
 Bolts, 4-8  
   ball and socket, 4-25  
   clearance, 4-18  
   self-aligning, 4-25  
 Borescope, 7-7  
 Brakes, for mounting stands, 4-22  
 Built-in test equipment (BITE), 1-2,5-4,7-1,7-2,7-3, 7-6, 7-9  
   artificial intelligence, use of, 7-9

## INDEX (cont'd)

- block diagram, use of, 7-17
  - definition, 7-9
  - example, maintenance planning effort, 7-3
  - maturation process, 7-9
  - output format, 7-16
  - sneak circuits in, 7-11
  - stimuli selection, 7-10
  - test point compatibility, 7-12
  - types, 7-16
  - versus automatic test equipment (ATE), factors to be considered, 7-11
- C**
- Cables, 4-10,4-18
    - connectors, 4-19, 4-20
    - routing, 4-19, 4-22
  - Calibration, sensors, 7-16
  - Capacitors, 4-8,5-5, 10-14, 10-22
  - Caps
    - color coded, 8-13
    - fuel, 8-10,8-13
    - spring loaded, 4-4
  - Career Management Fields (CM F), 9-13
  - Categories, sneak circuits, 7-16
  - CHAIN GUN, 5-13
  - Checklists
    - accessibility, 4-29
    - diagnostics, 7-26
    - identification, 6-17
    - interchangeability, 3-12
    - modularization, 5-16
    - preventive maintenance and servicing, 8-17
    - simplification, 2-7
    - standardization, 3-12
    - testability, 7-25
  - Chemical environment, 10-3
  - Circuit, 5-5
    - breakers, 10-22
    - diagrams, 6-1, 6-4
    - grouping, 5-5
    - simplicity, 3-1
    - sneak, 7-11
  - Cleaning, 4-26,5-5,8-7,8-15
    - solvents, 8-15
  - Clearance, nuts and bolts, 4-18
  - Clothing, 4-2, 6-4
  - Clutches, magnetic, 10-22
  - Collimation, 4-20
  - Color code
    - fuel caps, 8-10, 8-13
    - labels and signs, 6-6
    - parts, 6-5
    - perception, 9-6
    - piping, 6-4, 6-14
    - safety, 6-11, 6-14, 6-16, 6-17
  - Color, contrast and background, 6-11,6-14,6-15
  - Components. *See also* Throwaway and Modules
    - arrangement, 4-6
    - complexity, 1-7
    - dispersal, 4-8
    - grouping, 5-5
    - high failure rate, 4-8
    - location, 4-5,4-6,4-10, 8-8
    - off-the-shelf, 3-1
    - stacking, 4-8
  - Computer-aided designs for testability, 7-5
  - Conditioning monitoring, mechanical systems, 7-6
  - Connectors, electrical, 4-10,4-18,4-19,4-20, 4-22
  - Controls, 4-6
  - Corrective maintenance, 1-1,4-23
  - Corrosion
    - biological, 10-13
    - galvanic, 6-6, 8-14,8-15, 10-13
    - marine, 4-24
    - protection against, 4-24, 8-15, 8-16
    - stress, 6-6
  - Costs, 1-1, 1-5, 2-2, 5-2, 5-3, 5-7, 8-6
    - manufacturing minimization, 5-2
    - ownership, 8-3, 8-6
    - versus preventive maintenance, decision on effectiveness, 8-6
  - Covers. *See also* Doors
    - method of securing, 4-6
    - types, 4-3
  - Cowlings, 4-25,4-26
    - fasteners, 4-25
  - Crystals, 10-23
- D**
- DA Pam 700-12-1, *DA TMDE Preferred Items List (PIL)*, 3-10
  - Damping, 10-16
  - Decalomania, 6-6
  - Decision Coordinating Paper (DCP), 1-1
  - Defense Logistics Service Center (DLSC), 3-3, 3-8, 3-9
  - Delphi, technique for error estimation, 9-15
  - DELTA program, application of artificial intelligence, 7-10
  - Department of Defense Index of Specifications and Standards (DODISS), 3-6, 3-8
  - Desert environment, 10-14
  - Design trade-offs, 8-6
  - Detuning, 10-16
  - Diagnostics, 7-1. *See also* Testability
    - analysis for T700 gas turbine, 7-20, 7-21, 7-22, 7-24
    - automatic inspection, diagnostic, and prognostic system (AIDAPS), 7-12
    - capability, 7-5
    - block diagrams, use of, 7-17
    - checklist, 7-20, 7-26
    - condition monitoring, 7-6
    - definition, 7-5
    - design considerations

## INDEX (cont'd)

- built-in test equipment (BITE) versus automatic test equipment (ATE), 7-10
  - software, 7-10, 7-12
  - stimuli, 7-10, 7-16
  - test point identification, 7-10, 7-12
  - test point selection, 7-10, 7-11
  - test sequence, 7-10, 7-12
  - transducer (sensor), selection characteristics, 7-16
  - design needs, 7-5
  - equipment, 7-2, 7-6, 7-11
    - design needs for reliability, 7-5
    - function test performed
      - fault localization, isolation, and prediction, 7-10
      - hidden faults, 7-10
      - laboratory versus field performance, 7-5, 7-6, 7-10
      - verification by test and demonstration, 7-5
      - verification testing, 7-10
    - false alarms, 5-3, 7-2, 7-4, 7-5, 7-6, 7-8, 7-9
    - faults, 4-2, 7-1, 7-2, 7-5, 7-6, 7-9, 7-10, 7-12
    - likelihood analysis computer programs, 7-17
      - application to Advanced Attack Helicopter (AAH), 7-17, 7-18
    - maturation process, 7-6
    - mechanical systems, for, 7-6
    - output format, 7-16
    - reliability centered maintenance (RCM), relationship to, 8-3
    - requirement, 7-2
    - techniques
      - guidelines to improve, 7-5
      - importance of, 7-9
      - types, 7-7
    - turbine, gas, T700, analysis of, 7-20, 7-21, 7-22, 7-24
    - transducers (sensors) selection, 7-16
    - versus testability, 7-1
  - Dipsticks, 8-8, 8-10
  - Discard at failure, 5-2, 5-4
  - Documentation reduction, 5-2
    - due to standardization interchangeability, 3-2, 3-4
  - DoD Instruction 4120.19, *Department of Defense Parts Control Program*, 3-6, 3-7
  - Doors, access, 4-3
    - bottom support, 4-5, 4-6
    - captive bolts, quick opening, 4-3
    - hinged, 4-3, 4-4, 4-5
    - screwed down, 4-3
    - types, 4-3
  - Downtime, 5-1, 8-3, 8-7
  - Drainage, 8-16
    - cocks, 8-13
    - holes, 8-14, 10-2, 10-13
    - location, 8-14
    - plugs, 8-10, 8-13
    - requirements for, 8-13
    - valves, 8-13
  - Drawers, 4-4, 4-5, 4-10, 4-19, 4-28
  - Dust, 10-14
- E
- Electromagnetic pulse (EM P), 10-3, 10-17
  - Electromagnetic radiation, 10-3, 10-17
  - Electronic equipment, 7-1
    - environmental effect of
      - acceleration, 10-15, 10-17
      - arctic climate, 10-14
      - desert, 10-14
      - electromagnetism, 10-3, 10-17
      - nuclear radiation, 10-3, 10-4, 10-15, 10-17
    - failure modes, 10-22
    - foldout construction, 4-10, 4-16
    - hinged assembly, 4-10, 4-16
    - lugs, use of, 4-10, 4-18
    - modular design, 5-6
    - repair of, 4-10
      - use of logic flow diagram technique, 7-8
      - use of integral stands, 4-10, 4-16
    - service loops, 4-19
    - solid-state, 10-16
    - terminals, 4-10, 4-18
  - Encapsulation of modules, 5-2, 5-4
  - Engines, reciprocating, access to components, 4-25, 4-26, 4-27
  - Engraving, 6-6
  - Environment
    - defined, 10-1
    - effects on materiel, 10-3, 10-12
      - acceleration and protection against, 10-16, 10-17
      - arctic and protection against, 10-2, 10-14
      - desert and protection against, 10-2, 10-14
      - electromagnetic and protection against, 10-3, 10-17
      - moisture and protection against, 10-2, 10-13
      - nuclear and protection against, 10-15
      - shock and protection against, 10-2, 10-15
      - tropic and protection against, 8-15
      - vibration and protection against, 10-2, 10-15
    - effect on personnel, 10-2, 10-5
      - noise, 105
      - temperature, 10-2, 10-5
      - vibration and motion, 10-2, 10-10, 10-11, 10-12
  - factors, 10-1
    - conductive or synergistic, 10-2, 10-3, 10-4
    - induced, natural, combined, 10-2, 10-3, 10-4
    - limitation for unsheltered materiel, effect of factors and equipment failure made, 10-19
    - wartime, 10-2, 10-3, 10-4, 10-5
  - EQUATE, 7-9
  - Equipment accesses. *See* Access doors and Openings
  - Error, human, 9-13
    - causes, 9-13
    - contributing factors, 9-13
    - due to mislabeling, 6-1
    - quantification models, 9-15
    - rate estimation, 9-15, 9-16
    - reduction, 3-4
    - Siegel-Wolf model, for determining, 9-15
  - Expert system, 7-9

## INDEX (cont'd)

## F

Failure category severity, 8-3  
 Failure modes  
   detectable, 7-10  
   isolatable, 7-17  
 Failure modes and effects analysis (FMEA), 7-2  
 Failure modes, effects, and criticality analysis (FMECA), 7-3  
 False alarms, 5-3, 7-2, 7-4, 7-5, 7-6, 7-8, 7-9  
 Fasteners, 4-3  
   captive, 4-3  
   cowl, 4-25  
   effects of acceleration, on, 10-17  
   examples of, 4-21  
   nuts and bolts, 4-8  
   quick opening, 4-20, 4-25, 5-6  
   self-aligning, 4-25  
   standardization, 4-25  
 Faults  
   hidden, 7-10  
   insertion tests, 7-5, 7-6  
   isolation, 7-1, 7-9, 7-10, 7-12  
   localization, 7-10  
   prediction, 7-10  
   simulation, 7-2  
   tolerance, 7-9  
 Filters, 4-22  
   oil, 4-23, 4-24, 4-28  
 Fire control equipment, 4-20  
 Fluids  
   access, 8-13  
   drains. *See* Drainage  
   filling, 8-10  
   fuel tanks, vehicle, caps, rate, size, 8-10  
   injection systems, 5-9  
 Fonts, size and style for labels, 6-12, 6-13, 6-14  
 Frequency grouping, 5-5  
 Fuels  
   access to, 8-13  
   cells, 4-25  
   drains. *See* Drainage  
   filling, 8-10  
   tanks, vehicle, size, rate, caps, 8-10  
   filters, 4-22, 4-23, 4-24, 4-28  
   injection systems, 5-9  
 Function consolidation, 2-2  
 Fungous, 8-15, 8-16, 10-2, 10-20  
   inert materials, 8-15  
   protection, 8-15  
 Fuses, 2-2, 4-8, 5-5

## G

Galvanic action, 6-6, 8-14, 8-15, 10-13  
 Gas turbine T700, diagnostic evaluation, 7-20, 7-21, 7-22, 7-24

Gaskets, 8-16  
   seals, 8-16  
 Gears, 7-17, 8-7, 8-10  
 Generators, 8-7  
 GENRAD, 7-9  
 Gloved hand, size openings for, 4-15  
 Grouping for modularization, 5-4, 5-5  
   evaluation, 5-5  
 Gun, M230, 2-4  
 Gyroscopes, 10-23

## H

Handgrips, 4-10, 4-18  
 Handles, 4-8, 4-10, 4-18, 4-20, 5-6, 6-10  
   design, 4-10, 4-20  
   dimensionless, 4-17  
 Hand-tool use  
   frequency, 4-11  
   space requirements, 4-10  
 Hazards. *See* Safety  
 Hearing, 9-10  
 Helicopters  
   Advanced Attack (AAH), 5-6  
   Army Oil Analysis Program (AOAP), 8-10  
   artificial intelligence application, 7-10  
   availability, 8-6  
   built-in test equipment (BITE) application, 7-9  
   BLACK HAWK, UH-60A, 2-4  
   component dispersal, 4-8, 4-9  
   diagnostics, 7-7  
   engine, modular example, 5-13  
   fuel  
     drains, 8-14  
     lines, 8-14  
   modular design, 5-13  
   likelihood analysis program, 7-17  
     application to Advance Attack Helicopter (AAH), 7-17, 7-18  
   shock absorbers, 4-27  
 HELLFIRE missile system, 5-9  
 High failure rate components  
   delicate, 4-8  
   fuses, 4-8  
   location of, 4-8  
   stacking, 4-8  
 Hinged  
   assemblies, electronic equipment, 4-16  
   doors, 4-13, 4-19, 4-25  
 Hoists, 4-23  
 Housings, 4-28  
 Howitzer, 155-mm, 2-4  
 Human body measurements. *See* Anthropometric data  
 Human error. *See* Error, human  
 Human factors, 2-1, 4-1, 4-10, 9-1  
   design applicability  
     MIL-STD-759, 9-1

## INDEX (cont'd)

MIL-STD-1472, 9-1  
 failures attributable to, 6-1  
 hearing, 9-10  
   audio signals, 9-10  
     versus vision, 9-10  
   noise, speaker-to-listener distance, 9-11  
   sound intensity levels, 9-12  
 principles, MIL-H-46855, 9-1  
 relative to maintenance, 1-2, 4-10  
 sensory capacity, 9-4  
 sight, 9-4, 9-7  
   versus audio signal, 9-10  
 signals, when to use audio or visual, 9-11  
 strength, 9-4, 9-5, 9-6  
 touch, 9-11  
   recognizable knob shapes, 9-11  
 Humidity, 10-19. *See also* Moisture  
 Hydraulic equipment, 4-8,4-27, 5-5

## I

Identification of equipment and parts. *See* Labels and Labeling  
 Identification List, 3-8  
 Illumination requirements, 4-3, 9-1,9-6,9-7  
 Indicator levels, 8-10  
 Information sources for standard parts, 3-6  
   AR 700-60, *Department of Defense Parts Control Program*, 3-6, 3-7  
   AR 700-43, *Test, Measurement, and Diagnostic Equipment (TMDE)*, 3-10  
 Infrared suppressors, 2-4  
 Inspection, 4-3  
 Insulators, 4-10, 10-23  
 Integrated logistical support, 8-2  
 Intensity levels of sound, 9-12, 10-15  
 Interchangeability, 1-7, 3-1, 3-2  
   advantages, 3-3, 3-4  
   application to design, 3-3  
   checklist, 3-12  
   classes  
     local, 3-2  
     universal, 3-2  
   design principles, 3-3  
   examples of, 3-4  
   functional, 3-3  
   physical, 3-3

Jacks, 4-23  
 Job design, 2-2  
 Joints, solder, 10-23  
 Junction boxes, 4-24

## K

Kolmogorov-Smirnov Test, 1-3  
 Knobs, 6-10  
   shapes, 9-11

## L

Labeling, 6-1. *See also* Labels  
 aspects of, 6-1  
 contributions to human error, 6-1  
 lubrication fittings  
 methods, advantages and disadvantages of  
   adhesive-backed labels, 6-7  
   decalcomania transfers, 6-6  
   engraving, 6-6  
   ink stamping, 6-6  
   metal plates, 6-7  
   molding-in, 6-6  
   photocontact, 6-7  
   photoetching, 6-7  
   screen printing, 6-7  
   steel stamping, 6-6  
   stenciling, 6-6  
   tags, 6-7  
   purpose, 6-1  
 Labels, 10-2. *See also* Labeling  
 abbreviations, use of, 6-8  
 arrows, directional, 6-8, 6-9  
 basic characteristics, 6-2  
 color  
   recognition, 6-15  
   selection, 6-14  
 composition, 6-8  
 design, 6-11  
   character height, spacing, width, 6-12, 6-13, 6-14  
   color contrast, 6-11  
   font and size, 6-12, 6-15  
 display of information, 6-8  
 examples of, 6-3, 6-8, 6-9, 6-10, 6-11  
 font sizes, 6-2  
 functional information, 6-4, 6-8  
 hazards, 6-4  
 information to be contained in, 6-2, 6-7  
 instructional information, 6-4, 6-8  
 location/ position, 6-1, 6-2, 6-5, 6-9, 6-10  
 NATO force information, 6-1  
 purpose, 6-2  
 types, 6-2  
 warranty clauses, 6-2, 6-3  
 Languages, software, 2-4, 5-1, 5-3, 7-8, 7-10, 7-12  
 Lasers, 4-20,6-4, 10-4  
 Level indicators, fluid, 4-2, 8-10  
 Lever handles 5-6  
 Lids, spring loaded, 4-4  
 Life cycle costs, 2-2, 5-3  
 Lifting equipment, 4-23  
 Lift points, 6-4  
 Likelihood analysis computer program, 7-17  
   application to Advanced Attack helicopter, 7-17, 7-18  
 Line-replaceable unit, 5-1  
 Logic flow diagram technique, 7-7, 7-8  
 Logistic support, example of improvement by standardization/ interchangeability, 3-4  
 Logistic support plan, 2-1, 2-3,5-1, 5-3, 7-1

## INDEX (cont'd)

Logistics function of built-in test equipment (BITE) and automatic test equipment (ATE), 7-11  
 LOGMOD, 7-5  
 Lubrication, 4-6,6-4, 8-7, 8-8, 8-9, 8-10  
   aircraft, 4-26, 4-27  
   bearings, 4-28, 8-8  
   charts, 8-11  
   designs, MIL-STD-838, 8-7  
   fittings, 8-7, 8-8, 8-9  
     MIL-STD-454, 8-8  
     MIL-F-3541, 8-8  
   order, 8-10, 8-11  
   standard products, use of, 8-7, 8-8  
 Lugs, O- and U-types, use of, 4-10,4-18

## M

Maintainability  
   characteristics, 1-2  
   cooperation with industry, 1-7  
   costs, 1-1, 1-2, 1-5, 1-7  
   criteria, 1-1, 2-1, 2-3  
   features to facilitate, 1-7  
   goals, 2-3  
   importance of, 1-1  
   inherent value, 1-4  
   level of effort, 1-5  
   measures, 1-2  
     quantitative, 1-1  
   objectives, 1-5  
   operational readiness, 1-1  
   physical factors  
     relevancy of, 9-15  
     built-in test equipment (BITE) and automatic test equipment (ATE) related, 7-11  
   plan, 1-6, 7-11  
     application matrix, 1-6  
     MIL-STD-470, 1-6  
     tailoring, 1-6  
   program, 1-5, 1-7  
   requirement, verification, demonstration, and evaluation of 1-7  
     AR 702-3, 1-7  
     MIL-STD-471, 1-7  
   risk area, 1-1  
   versus maintenance, 1-1  
 Maintenance, 2-1  
   actions, 4-2  
   availability, related to, 8-3  
     equations related to quantitative maintenance parameters, 8-3  
   built-in test equipment (BITE) related, 7-3  
   climate extremes, performance in, 10-6  
   corrective, 4-1, 4-23, 8-1  
     design considerations, 8-7  
     relationship to preventive maintenance, 8-2  
   costs, 2-1, 8-3, 8-6  
   depot, 2-4

design consideration, 8-7  
 diagnostics, importance of, 7-7  
 distributions, 1-2, 3-5  
   Gaussian (normal), 1-3  
   lognormal, 1-3  
   time, 1-4  
 float, 5-2  
 human Factors influence, 2-1, 4-1, 9-1  
 management, 9-15  
 manuals, 3-1, 3-4, 3-8, 5-2, 5-4, 6-1,8-3, 9-13  
 personnel, 9-13  
   Manpower and Personnel Integration Program (MANPRINT), 9-1  
 plan, 8-2  
 preventive, 1-1, 4-23, 8-1  
   checklist, 8-17  
   cost of ownership, effect on, 8-3, 8-6  
   relationship to corrective maintenance, 8-6  
   trade-offs, 8-3, 8-6  
   versus repair, decision on cost-effectiveness, 8-6  
 procedures  
   scheduling, 2-3, 2-4  
   streamlining, 2-3  
 redundancy, effect on, 7-2  
 reliability centered (RCM), 8-2  
   analysis process, 8-3, 8-4  
   concept exploration phase, relation to, 8-2  
   data, disposition of, 8-3, 8-5  
   objectives, 8-2  
   time of application, 8-3  
 time, active, 1-2  
 trade-offs, 8-3, 8-6  
 scheduled, 1-1, 7-5  
 servicing, 8-1  
   checklist, 8-17  
 simplification, 2-3  
 unit level, 2-4  
 unscheduled, 1-1  
 Magnetic chip detectors, 8-8  
   MS35844, 8-8  
 Malfunction isolation, 2-3  
 Manuals, 3-1, 3-4, 3-8, 5-2, 5-4, 6-1, 8-3, 9-13  
 Marine  
   equipment, 4-24  
   fouling, 4-24  
     antifouling agents, 4-24  
 Marking. See also Labels and Labeling  
   center of gravity (CG), 6-4  
   doors, access, 4-24,4-25  
   functional information, 6-4  
   hazards, 6-4  
   instructional information, 6-4  
   safety, 6-4, 6-7, 6-11, 6-14, 6-16, 6-17, 10-14  
   security, 5-4  
 Materials  
   acceleration, effect of, 10-17  
   corrosion resistance, 8-16  
   flexible, 10-15

## INDEX (cont'd)

- fungous inert, 10-13
  - metals, precious, 5-4, 10-17
  - paints, lacquers, varnishes, 10-14
  - rubber, 10-14
  - Metals
    - dissimilar, 6-6, 8-14, 8-15, 10-13
    - precious, 5-4, 10-17
  - Meters. 10-16
    - readout, 7-16
  - Microbiological organisms, 10-2
  - Microwave radiation, 10-4, 10-5
  - Military environment, 10-2, 10-3, 10-4, 10-5
  - Military Occupational Specialty (MOS), 9-13
  - Military Occupational Specialty Code (MOSC), 9-13
  - Missiles, 4-20, 9-1
  - Mobile equipment, design, 4-20
  - Modification, 5-2
  - Modular design, 5-9
  - Modularization, 2-2, 5-1. *See also* Modules and Throwing items
    - advantages, 5-1, 5-2
    - checklist, 5-16
    - design guidelines, 5-6
    - examples of technique
      - armament, 5-9
      - electronics and electrical equipment, 5-6
      - helicopter engine, 5-13
      - missiles and rockets, 5-9
      - tank-automotive, 5-9
    - functional grouping for
      - circuits, 5-5, 5-7
      - components, 5-5, 5-7
      - evaluation of techniques, 5-5
      - frequency of replacement, 5-5
      - logical flow, 5-4
      - standard construction, 5-5
    - tank engine assembly, 5-9, 5-10
    - testability and diagnostics, related to, 7-2
    - vehicle design, 5-6
  - Modules. *See also* Modularization and Throwing items
    - automatic test equipment (ATE) related, 7-8
    - cost considerations. 5-1
    - criteria for use, 5-4
    - definition, 5-1
    - disposal, 5-4
    - encapsulation, 5-4
    - independent check capability, 5-6
    - interchangeability, 5-1
    - Navy Standard Electronic Module Program (SEM), 5-7
    - plug in, 4-2
    - replacement, 5-1
    - self-isolating, 7-13
    - software, 5-3
    - throwaway, 5-3, 5-4
    - trade-off with piece part, 5-4
    - weight limitations, 5-5, 5-6
  - Moisture, 4-4, 10-13. *See also* Humidity
    - protection against, 8-15, 10-13
  - Molded-in identification label, 6-6
  - Monitoring equipment, on-line, 7-7
  - Motion sickness, 10-10, 10-12
  - Motivation, 9-13
  - Motors, 8-7, 10-23
  - Mounting, blind. *See* Blind mountings
- N
- Nacelles, engines, 4-28
  - Nameplates. *See* Labels and Labeling
  - National Codification Bureau Code (NCBC), 3-3, 3-9
  - National Item Identification Number (NIIN), 3-9
  - National Stock Number, 3-6, 3-8, 3-9, 6-5
  - Navy Standard Electronic Module Program (SEM), 5-Noise, 9-11, 9-12
  - Nondestructive testing, 7-7
  - Nondevelopment Item (NDI), 10-1
  - Nuclear radiation
    - environment, 10-15
    - hazard warning symbol, 6-17
  - Numeral and letter sizes, 6-12, 6-13, 6-14
  - Nuts, 4-8
- O
- Oil
    - filters, 4-23, 4-24, 4-28
    - levels, 8-10
    - pressure, 8-8
    - standard products, use of, 8-7, 8-8
  - Openings. *See* Doors
  - Ozone, 8-15, 10-20
- P
- Packaging for access, 4-1
  - Paint, 10-14
    - antifouling, 4-24
  - Parts Control Board, 3-7
  - Parts
    - access to, 2-3
    - configuration, 2-3
    - identification, 1-7, 6-1
    - information sources on control of
      - Military Parts Control Advisory Group (MPAG), 3-7
      - MIL-STD-143, 3-6, 3-7, 3-8
      - MIL-STD-965, 1-7
      - Program Parts Selection List (PPSL), 4-23
      - SB 700-20, 3-8
    - marking, 6-5. *See also* Labels and Labeling
    - numbering system, 3-9
  - Photocontact, 6-7
  - Photoetching, 6-7
  - Plastic covers, 4-3

## INDEX (cont'd)

- Platforms, 4-22
- Plug-in items  
isolatable, 7-2  
orientation of, 4-8
- Plugs  
drain. *See* Drainage  
threaded, 8-10, 8-13
- Pressure, 10-19
- Preventive maintenance. *See* Maintenance, preventive
- Preventive Maintenance Checks and Service (PMSC), 4-23
- Program Parts Selection List (PPSL), 3-7
- Propulsion systems  
aircraft, 4-25  
parts to be readily accessed, 4-25,4-26  
related to diagnostic, 7-6
- Publications. *See also* Technical manuals  
reduction of by standardization, 3-2
- Psychological factors, 4-1,9-1,9-13  
MIL-STD-1472, 9-13  
motivation, 9-13  
noise, 9-11  
training, 9-13
- Q**
- Qualified Products List (QPL), 3-6,3-8
- Quick-release fasteners, 4-20,4-25,5-6
- R**
- Racks, 44,4-5
- Radar, 7-14, 7-15
- Radio frequency warning sign, 6-16
- Rails, use of, 4-20,4-25
- Rationalization, Standardization, and Interoperability (RSI) program, 3-3  
objectives, 3-3
- Receptacles, marking, 6-4
- Reciprocating engine components, 4-25,4-26,4-27
- Redundancy, 7-2,7-20
- Relays, 5-5, 10-14, 10-16, 10-24
- Reliability, 1-1, 5-2, 5-3, 7-2, 7-5  
related to built-in test equipment (BITE) and automatic test equipment (ATE), 7-11
- Reliability centered maintenance (RCM), 8-2
- Repair time, attributes affecting, 1-2
- Resins, synthetic, 8-15
- Resistors, 4-8,5-5, 10-24
- Rubber, 8-15  
eyepiece, 4-20
- S**
- Safety, 4-1,4-2,4-4,4-6,4-8, 6-4,6-7,6-11, 8-3, 8-10, 8-15, 10-5  
color, 6-11  
markings, 6-4, 6-11, 6-14, 6-16, 6-17
- Salt spray, 10-19
- Sand and dust, 10-2, 10-19
- Scheduled maintenance, 1-1. *See also* Maintenance
- Screen printing, 6-7
- Screwed-down covers, 4-3
- Seals, 10-14, 10-20  
compounds, 10-15  
hermetic, 7-1, 10-13  
oil, 8-8
- Security classification, throwaway modulus, 5-4
- Sensors, selection characteristics. 7-16. *See also* Transducers
- Servomechanisms, 10-24
- Shelves, 4-4, 4-5
- Shock, 10-15  
absorber, 4-27  
mounts, 10-2
- Siegel-Wolf model for human error determination, 9-15
- Sights, 4-20
- Simplification, 1-7, 2-1  
checklist, 2-5, 2-7  
design techniques, 2-1  
examples of  
IR suppressor, 2-5  
M230 Gun, 205  
muzzle plug, 155-mm howitzer, 2-5  
UH-60A Helicopter (BLACK HAWK), 2-4  
modules, use of, 5-1
- Skin, aircraft, hinged, 4-25
- Sneak circuits, 7-11  
categories, 7-11
- Snow, 10-14
- Software  
languages—ADA, C, PASCAL, 2-4  
maintenance, 2-4  
modules, 5-1, 5-3  
advantages, 5-3  
design criteria, 5-3  
relationship to diagnostic techniques, 7-8, 7-10, 7-12  
automatic inspection, diagnostic, and prognostic system (AIDAPS), 7-12  
debugging, 7-12  
language selection, 7-12  
structured programming, 7-12
- Solid-state electronic devices, 10-16, 10-25
- Solvents, 8-15
- Sound levels  
associated with weapons, 10-5  
limits of intensity, 9-12
- Split-line design, 4-25
- Stacking, components, 4-8
- STAMP, 7-5
- Stamping  
rubber, 6-6  
steel, 6-6
- Standardization, 3-1. 3-9  
advantages, 3-2, 3-4  
applications to design, 3-3  
checklist, 3-12

## INDEX (cont'd)

- definition, 3-1
  - examples of, 3-4
  - goals and principles, 3-2
  - importance of, 3-2
  - Stands, maintenance, 4-16,4-22
    - design for stability, 4-22
  - Static electricity, 10-16
  - Stenciling, 6-6
  - Surfaces, walking, 4-22
  - Switches
    - environmental effects on, 10-14, 10-24
    - location of, 4-8
  - Symmetrical designs, 3-4
  - System
    - availability, 1-1, 4-1, 8-3
    - experts, 7-9
  - System Concept Paper, 1-1
- T
- Tank automotive equipment, 4-22
    - example of increased availability of redesign of U-joint, 4-23
    - frequency of maintenance tasks, 4-23, 4-24
    - lubrication order, 8-10, 8-11
    - modular design, 5-9
    - stress cracks, access panel corners, 4-24
  - Target Acquisition Designation System (TADS), 5-6, 5-8
  - Technical manuals, 3-1, 3-4, 3-8, 5-2.5-4, 6-1, 9-13
  - Technician, typical, 9-13
  - Temperature, 10-5
    - effective, 10-6, 10-7
    - limits and extremes, 10-6, 10-7, 10-8, 10-9, 10-10
    - wet-bulb global, 10-6
    - windchill index, 10-6, 10-9
  - Termites, 8-15
  - Testability, 1-7, 7-1
    - analysis, 7-1
      - guidelines for, 7-2
    - checklist, 7-20, 7-25
    - computer-aided techniques, 7-5
    - definition, 7-1
    - method of achieving, 7-1
    - relation to reliability centered maintenance (RCM), 8-3
    - test point
      - example of selection process, 7-12
      - identification, 7-12
    - test sequence, 7-12,7-13
      - examples of, 7-14,7-15
  - Test equipment, 3-1
    - flow chart selection, 3-11
  - Test, Measurement, and Diagnostic Equipment (TMDE), 3-6, 3-9, 3-10
    - AMC's role as executive director, 3-10
    - US Army TMDE Support Group (USATSG), 3-10
  - Testing, 4-2
    - for maintainability, 1-7
    - verification, 7-10
  - Test, Measurement, and Diagnostic Equipment (TMDE), 3-6,3-9,3-10
  - Test Points
    - example of selection process, 7-12
    - identification of, 7-12
  - Thermistors, 10-24
  - Throwaway items, 7-13
    - advantages, 5-2
    - classified items, 5-4
    - concept, 5-2
    - containing precious metals, 5-4
    - criteria for, 5-4
    - feasibility, 5-3
    - hazards, 5-3
    - level of accessibility, 4-1
    - location, 4-2
    - strategy, 5-2
  - Touch, sense, 4-2, 9-11
  - Track radar transmitter, example of test sequence, 7-14, 7-15
  - Trade-offs
    - for maintainability, 2-1
    - parameters, 8-3
    - preventive maintenance versus repair costs, 8-6
  - Trailers, design, 4-20
    - mating surfaces, 4-20, 4-22
  - Training, 9-13
    - reduction due to standardization, 3-2
  - Transducers, 7-10, 7-16
    - selection characteristics, 7-16
  - Transformers, 10-16, 10-25
  - Transistors, 5-5, 10-15, 10-25
  - Transmissions, 7-17
  - Tropical environment, 7-15
  - Troubleshooting, 7-1, 7-5, 7-7, 7-8, 7-9, 7-10. *See also* Diagnostics
  - Turbines, 4-26
    - blade removal, 4-26,4-27
    - gas, T700, diagnostic evaluation of, 7-20, 7-21, 7-22, 7-24
  - Type sizes for labels, 6-2,6-12,6-13,6-14
- U
- Units, International System (SI) of, 3-3
  - Unscheduled maintenance, 1-1. *See also* Maintenance
  - US Army TMDE Support Group (USATSG), 3-10
- V
- Value engineering, 2-2
  - Valves
    - check, 2-2
    - control marking, 6-11
  - Van trailers, 4-22
  - Vehicle replacement parts, frequency of occurrence, 4-23,4-24

**INDEX (cont'd)**

Verification of maintainability, 1-7  
Very high-speed integrated circuits (VHSIC). artificial intelligence related, 7-9  
Very large-scale integrated circuits (VLSIC). artificial intelligence related, 7-9  
Vibration and motion, 10-12, 10-15  
    limits and tolerances, 10-10, 10-11, 10-12  
    whole body, 10-10, 10-11  
Visibility of components, 1-7  
Visual fields, 9-6, 9-7  
Voltage, marking, 6-4  
Warranties, placed on labels, 6-2  
Warsaw Pact Forces, 3-3

Wartime environment. 10-2  
Wet-bulb global temperature. 10-6  
Windchill index, 10-6, 10-9, 10-10  
Wiring, 4-8, 4-10, 10-16  
    cables. 4-10, 4-18, 4-19  
    connections, 4-20, 4-22  
    spacing, 4-10, 4-18  
    terminals, 4-10, 4-18  
    use of O- and U-type lugs, 4-10, 4-18

**X**

X rays, 7-7, 10-4. 10-5

MIL-HDBK-791 (AM)

CUSTODIAN:  
ARMY-AM

PREPARING ACTIVITY:  
ARMY-AM

(PROJECT MISC-A009)



**INSTRUCTIONS:** In a continuing effort to make our standardization documents better, the DoD provides this form for use in submitting comments and suggestions for improvements. All users of military standardization documents are invited to provide suggestions. This form may be detached, folded along the lines indicated, taped along the loose edge (*DO NOT STAPLE*), and mailed. In block 5, be as specific as possible about particular problem areas such as wording which required interpretation, too rigid, restrictive, loose, ambiguous, or was incompatible, and give proposed wording changes which would alleviate the problems. Enter in block 6 any remarks not related to a specific paragraph of the document. If block 7 is filled out, an acknowledgement will be mailed to you within 30 days to let you know that your comments were received and are being considered.

**NOTE:** This form may not be used to request copies of documents, nor to request waivers, deviation, or clarification of specification requirement on current contracts. Comments submitted on this form do not constitute or imply authorization to waive any portion of the referenced document (s) or to amend contractual requirements.

---

(Fold along this line)

---

(Fold along this line)

---

DEPARTMENT OF THE ARMY



NO POSTAGE  
NECESSARY  
IF MAILED  
IN THE  
UNITED STATES

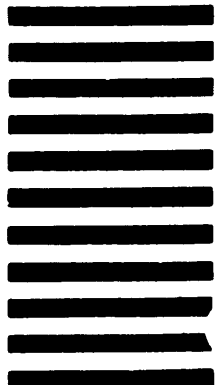
---

**OFFICIAL BUSINESS**  
PENALTY FOR PRIVATE USE \$300

**BUSINESS REPLY MAIL**  
FIRST CLASS PERMIT NO. 12062 WASHINGTON D. C.

POSTAGE WILL BE PAID BY THE DEPARTMENT OF THE ARMY

Commandant  
School of Engineering and Logistics  
ATTN: AMXMC-SEL-E  
Red River Army Depot  
Texarkana, TX 75507-5000



# STANDARDIZATION DOCUMENT IMPROVEMENT PROPOSAL

(See Instructions – Reverse Side)

1. DOCUMENT NUMBER  
DOD-HDBK-791(AM)

2. DOCUMENT TITLE  
Maintainability Design Techniques

3a. NAME OF SUBMITTING ORGANIZATION

4. TYPE OF ORGANIZATION (Mark one)

VENDOR

USER

MANUFACTURER

OTHER (Specify): \_\_\_\_\_

b. ADDRESS (Street, City, State, ZIP Code)

## 5. PROBLEM AREAS

a. Paragraph Number and Wording:

b. Recommended Wording:

c. Reason/Rationale for Recommendation:

## 6. REMARKS

7a. NAME OF SUBMITTER (Last, First, MI) – Optional

b. WORK TELEPHONE NUMBER (Include Area Code) – Optional

c. MAILING ADDRESS (Street, City, State, ZIP Code) – Optional

8. DATE OF SUBMISSION (YYMMDD)

**DD** FORM 1426  
82 MAR

PREVIOUS EDITION IS OBSOLETE.