

NOT MEASUREMENT
SENSITIVE

MIL-HDBK-57E (IS)
25 NOVEMBER 2008
SUPERSEDING
MIL-HDBK-57D (IS)
4 JUNE 2008

DEPARTMENT OF DEFENSE HANDBOOK

LISTING OF FASTENER MANUFACTURER'S IDENTIFICATION SYMBOLS



**This handbook is for guidance only.
Do not cite this document as a requirement.**

AMSC N/A

FSC 53GP

DEPARTMENT OF DEFENSE
WASHINGTON, D.C. 20301

FORWARD

Listing of Fastener Manufacturer's Identification Symbols

MIL-HDBK-57D(IS)

1. This Military Handbook
2. Comments, suggestions, or questions on this document should be addressed to Defense Supply Center Philadelphia (DSCP), ATTN: DSCP-NASA, 700 Robbins Avenue., Philadelphia, PA 19111-5096 or e-mail to dscpg&inspeccomments@dla.mil. Since contact information can change, you may want to verify the currency of this address information using the ASSIST Online database at <http://assist.daps.dla.mil>.
3. Copies of these documents are available online at <http://assist.daps.dla.mil/quicksearch/> or from the Standardization Document Order Desk, 700 Robbins Avenue, Building 4D, Philadelphia, PA 19111-5094

FORWARD

This handbook is a compilation of the identifying symbols of fastener manufacturers as provided by the manufacturers themselves. This issue contains the names, addresses, and the symbols of all fastener manufacturers whose identifying symbols were received by 30 November, 2006. Each manufacturer who was listed in Revision B of this document was contacted to confirm the accuracy of the published information. We have annotated the listing to indicate those manufacturers that have responded to confirm or update appropriate information. The listing also annotates which manufacturers have not responded. Information about manufacturers who have not responded is still maintained in this latest revision. For the purpose of this handbook, a manufacturer is defined as the source which substantially makes the supplies, either by hand or machinery out of raw materials. Fasteners, as defined for the purpose of this handbook, refer to those threaded items included in Federal Supply Class (FSC) 5305 – Screws, 5306 – Bolts, 5307 – Studs, and 5310 – Nuts. As additional manufacturers submit their markings, the handbook will be updated.

All requests to be listed in the handbook should be addressed to:

Defense Supply Center Philadelphia (DSCP)
Attention: DSCP-NASA
700 Robbins Avenue.
Philadelphia, PA 19111-5096
or e-mail to dscpg&inspeccomments@dla.mil.

In addition to the alphabetic index of manufacturers (Index A), this revision of the handbook incorporates a listing of manufacturers indexed by their identification symbol (index B).

At the back of this handbook is a registration form. Manufacturers wishing to be listed must complete this form and return it to DSCP. Submit the completed form, along with your fastener identification symbol artwork used on the fastener. All submittals must be in the English language.

DSCP does not “approve”, “rate”, or “endorse” any item, construction, proprietary device, or activity.

DSCP is not responsible for the accuracy or completeness of the information contained in this publication.

DSCP does not take any position with respect to the validity of any patent rights asserted in connection with any items mentioned in this document, and does not undertake to insure anyone utilizing a code, standard, or guide against liability for infringement of any applicable Letters Patent, nor assume any such liability. Users of code, standard, or guide are expressly advised that determination of the validity of any such patent rights, and the risk of infringement of such rights, is entirely their own responsibility.

DSCP reserves the right to monitor this document to ensure that it contains the listing of only bona-fide fastener manufacturers.

DSCP has solicited the assistance of the Defense Contract Management Agency (DCMA) and the Defense Management Command International (DCMCI) in an effort to identify non-manufacturers and remove them from the manufacturers’ listing. DCMA/DCMC’s evaluation of a company’s status is based on an in house capability to manufacture fasteners (screws, bolts, studs and nuts), with respect to space, equipment, and trained personnel. On an on-going basis, any company identified by DCAS/DCMCI as a non-manufacturer will be removed from the manufacturers’ database and MIL-HDBK-57C (IS).

INDEX A - MANUFACTURER

Company Name		Page	Company Name		Page
3 V FASTENERS			AERO-FAB, INC.		
			AEROFAB, INC.		
3D MACHINE COMPANY, INC.			AEROFAB SUPPLY		
			AEROFAB SUPPLY		
A			AEROMAX INDUSTRIES INC DBA AEROMAX INTERNATIONAL		
			AEROMAX INDUSTRIES INC DBA AEROMAX INTERNATIONAL		
A & E MACHINED PRODUCTS INC SYSTEMS CORPORATION			AEROSPACE MANUFACTURING		
A & E MACHINED PRODUCTS INC SYSTEMS CORPORATION			AEROSPACE MANUFACTURING		
NORTHROP GRUM			AEROSPACE MARINE SPECIALTY FASTENERS & FITTINGS		
A & G ENGINEERING CO., INC.			AEROSPACE MARINE SPECIALTY FASTENERS & FITTINGS		
A & M AEROSPACE, INC.			INC. DBA AMS FASTENERS		
A & N PRECISION INDUSTRIES LTD			AEROSPACE PRODUCTS		
A & R MFG CO INC.			AEROSPACE PRODUCTS		
A & W SCREW MACHINE PRODUCTS, INC.			DIV OF APCO FASTENERS, INC		
A. AGRATI S.P.A.			AEROSPACE PRODUCTS CO. DIV WBH		
A. P. MILLS INDUSTRIES FOR THE BLIND			AEROSPACE PRODUCTS, INC.		
A-1 NUT AND BOLT CO INC			AEROSPACE RIVET MFG CORP		
DIV OF GREENCO PACIFIC INC			AEROSTAR ENGINEERING & MANUFACTURING COMPANY		
A-1 THREAD ROLLING CO., INC.			AEROSTAR FASTENER CORP.		
AAP ACQUISITION CORP			AEROTECH FASTENERS, INC.		
DBA ACHILLES AEROSPACE PRODUCTS			AEROWIND CORPORATION		
AASTRO ENGINEERING			AF FASTENERS LIMITED		
ABBOTT INTERFAST CORP.			AFAB PRECISION MACHINING		
ABBOTT PETER (AEROSPACE) 1982 LTD.			AFI INDUSTRIES, INC.		
ABC TOOL & DIE ENGINEERING & MANUFACTURING LLC			AIHARA SEIBYO CO LTD		
ABSCOA INDUSTRIES			AIR INDUSTRIES CORPORATION		
ACCUFORM, INC.			AIR PARTS MFG. CO.		
ACCURATE AUTOMATIC PARTS INC			AIR-COM, INC.		
ACCURATE PRECISION FASTENERS, INC.			AIRCRAFT ENGINEERING PRODUCTS, INC		
ACCURATE SCREW MACHINE CORP DBA ASM			AIRCRAFT FUELSEAL FASTENERS, INC.		
ACCURATE THREADED FASTENS			AEROLITE BLIND RIVET DIVISION		
DIV OF BEATRICE FOODS CO			AIRDRONE PARTS CO		
ACCURATE THREADED PRODUCTS CO.			AIRFASCO, INC.		
ACCURATE TOOL CO INC			AIW-ALTON INC		
ACCU-TECH MANUFACTURING AND SUPPORT, INC.			AKKO FASTENER, INC.		
ACCUTOOL			ALAN JEFFREY MFG. & ENGR.		
SUBCON TOOL/ACCUTOOL MACHINE GROUP INC.			ALARD MACHINE PRODUCTS		
SEE SUBCON TOOL			ALBAR MACHINE CORPORATION		
ACE G & M COMPANY OF TEXAS INC			ALCO MACHINE CO.		
DBA ACE GRINDING & MANUFACTURING			ALCOA FASTENING SYSTEMS		
(PLANT SEE SHAW)			CAMLOC PRODUCTS		
ACE GRINDING CO INC			HUCK AEROSPACE PRODUCTS		
ACE PRECISION INDUSTRIES, INC.			HUCK INDUSTRIAL PRODUCTS		
ACHILLES AEROSPACE PRODUCTS, INC.			KAYNAR PRODUCTS		
ACI			KELOX/MICRODOT PRODUCTS		
ACIMET MFG.			MECAERO PRODUCTS		
ACME MACHINE PRODUCTS			RAM PRODUCTS		
ACME RIVET & MACHINE CORP.			ROSAN PRODUCTS		
ACME SCREW COMPANY			SIMMONDS PRODUCTS		
ACRODYNE MFG CO			TRIDAIR PRODUCTS		
DIV MACK INTERNATIONAL OPERATIONS			VOI-SHAN PRODUCTS		
ACUFAST AIRCRAFT PRODUCTS			ALCOA GLOBAL FASTENERS INC		
ADAMS INDUSTRIES INC			ALEXANDER MANUFACTURING COMPANY INC		
A SUB OF BANNER INDUSTRIES INC			DBA METRO TOOL & MANUFACTURING CO		
ADAMS, EARL M. CO.			ALL MANUFACTURERS INC		
ADC COMMUNICATIONS CORP			DBA HARPER AEROSPACE FASTENERS		
ADI MANUFACTURING, INC.			ALL PINS MANUFACTURING		
ADJUSTABLE BUSHING CORP.			ALL QUALITY SPARES, INC.		
ADOM ENGINEERING			ALLFAST FASTENING SYSTEMS, INC.		
ADVANCE PATTERN CORP			ALLIED NUT & BOLT CO., INC.		
ADVANCED CNC MANUFACTURING			ALLIED PRECISION PRODUCTS, INC.		
ADVANCED MACHINING & FABRICATING INC			ALL-POWER MFG. CO.		
ADVANCED MACHINING TECHNOLOGIES			ALL-PRO FASTENER & RIVET MFG. CO.		
ADVANCED PLASTICS INC			ALL-STATES INC.		
DBA ADVANCED MCHNING FBRCTIONG INC			ALPHA BOLT CO.		
AERCO RESEARCH			ALPHA FASTENERS		
AERO BUSHING AND COMPONENT			ALPHA MACHINING PRODUCTS & DEVELOPMENT		
AERO COMPONENTS CO.			ALPINE MACHINE & TOOL CORP.		
AERO DYNAMIC MACHINING, INC.			ALPS SEIKO CO., LTD.		
AERO ENGINEERING & MANUFACTURING CO OF CALIFORNIA			Plant - LIDA FACTORY		
DBA AERO ENGINEERING			AMACON CORP.		
AERO MECHANICAL FASTENING SYSTEMS			AMANDA BENT BOLT CO		
AEROBOLT MANUFACTURING, INC.			AMATOM ELECTRONIC HARDWARE		
			DIVISION OF QUINCY TECHNOLOGIES, INC.		
			AMERICAN AIRCRAFT PARTS MANUFACTURING COMPANY		
			AMERICAN ELECTRIC		
			CONSTRUCTION MATERIALS GROUP		
			See THOMAS & BETTS CORP		
			AMERICAN FASTENER & SPECIALTY CO.		
			AMERICAN INTERNATIONAL AERO MFG INC		
			AMERICAN METAL BEARING COMPANY		
			AMERICAN QUALITY INDUSTRIES		
			FASTENER DIVISION		
			AMERIFAST CORP.		

MIL-HDBK-57E (IS)

Company Name	Page	Company Name	Page
AMERITECH FASTENER MFG INC	15	BEACH MACHINE	25
DIVISION OF LONE STAR FASTENERS, LP		BEAVER PRODUCTS CORP.	26
AMMAC, INC.	16	BEC MACHINE PRODUCTS COMPANY	26
ANATASE PRODUCTS	16	BEE INDUSTRIES, INC. (WISCONSIN CORPORATION)	26
DIV OF HENWAY INC		BEGONIA TOOL COMPANY	26
ANCHOR BOLT & SCREW CO.	16	BEK LEVEL 1 FASTENERS	26
ANDERSON FORGE & MACHINE	16	BELL FASTENERS	27
ANILLO INDUSTRIES, INC	16	ALBANY FATENERS/PAWTUCKET FASTENER DIVISION	
ANOTHER SCREW MACHINE PRODUCT	16	(also see VERTEX)	
A-ONE MACHINE COMPANY	16	BELL PRECISION, INC.	27
APEL LTD.	16	BELL-MEMPHIS, INC.	27
APEX MFG. CO. INC	17	BEN YUAN ENTERPRISE CO, LTD.	27
APHEONIX CORPORATION	17	BENAGO TOOLING RESEARCH & DEV. CORP	27
ARCHER SCREW PRODUCTS	17	BEOTOOL CORP.	27
ARCO SALES CO.	17	BERGNER, RICHARD GMBH & CO.	28
ARDOR MFG. INC.	17	BER-LOW MFG INC	28
ARGARWAL INDUSTRIES	17	DBA BUTECH PRESSURE SYSTEMS	
ARJAY PRECISION, INC.	17	BERRY, JOHN DBA BERRY MANUFACTURING	28
ARMSTRONG ATLAS BOLT	18	BERRY MANUFACTURING	28
ARMSTRONG FASTENING SYSTEMS	18	BETA CORP.	28
ARMSTRONG FASTENINGS LTD.	18	BETA ENGINEERING, INC.	28
ARNOLD KNIPPING GmbH	18	BIG BOLT CORP.	29
ARNOLD UMFORMTECHNIK GMBH & CO. KG	18	BISHOP ENTERPRISES, INC.	29
ARNOLD WRAGG (BOLTS & NUTS) LTD	19	BLAINE TOOL CORP.	29
ARROW SCREW & MACHINE WORKS	19	BLANC AERO INDUSTRIES	29
ARTISAN SPECIALIST TECH, INC	19	BLANC AIRCRAFT FASTENERS, INC.	30
ARVAN, INC.	19	BLAND CO., THE	30
ASAHI SREWS MANUFACTURING CO., LTD	19	BLUE SKY INDUSTRIES, INC	30
ASAI TEKKO CO. LTD	19	BLUE TEE CORP	30
ASI DESIGN & MANUFACTURING, INC.	19	DBA GEFCO/ STECO	
ASL MANUFACTURING, INC.	19	BOBCAT MANUFACTURING CO.	30
ASSOCIATED TOOL CO., INC.	20	BOGNER ENGINEERING CO.	30
ATF INC	20	BELLHOFF & CO. GmbH & CO. KG	30
ATLAS ENGINEERING, INC.	20	BOLT & NUT CO.	30
PENN ENGINEERING COMPANY		BOLT FASTENER STUD/TECHNOLOGY	31
ATLAS SPECIALTY PRODUCTS	20	BOLTWORKS, INC.	31
See CURTIS PRESTON ENTERPRISES INC		BOMAR ENGINEERING, INC.	31
AUGUST FRIEDBERG GMBH	20	BOMBHELL, INC.	31
AUGUST FRIEDBERG GmbH	20	BRACELENTE MANUFACTURING CO., INC.	31
AUTO BOLT AND NUT CO.	20	BRADY MACHINE, INC.	31
AUTOMATED MANUFACTURING	21	BRANCH MACHINE PARTS, INC	31
AUTOMATIC MACHINING AND MFG CO DBA AMMAC INC	21	BRIARWOOD FASTENERS, INC	31
AUTOMATIC MANUFACTURING COMPANY	21	BRIDEAN MACHINE & TOOL CO., INC.	32
AUTOMATIC SCREW MACHINE PRODUCTS CO.	21	BRIDGEVIEW MANUFACTURING CO.	32
AUTO SCREW, INC.	21	ILLINOIS CORPORATION	
AVDEL INTERNATIONAL (AVDEL LTD)	21	BRIGHT LIGHTS USA, INC.	32
AVIATION MANUFACTURING GROUP LLC	21	BRINTCLIFFE TURNER LTD.	32
DBA FREEMAN CO., THE		BRISTOL INDUSTRIES	32
AVIBANK MANUFACTURING, INC.	22	BRISTOL LOCKNUT CO.	33
PRECISION CASTPARTS CORP.		NUT DIVISION	
AVK INDUSTRIES PRODUCTS INC		BROADSTONE TOOL & DIE, INC.	33
AZTECH ENGINEERING, INC	22	BROWN PRODUCTION, INC	33
B		BRUNNER DRILLING & MFG. CO., INC.	33
B & B SPECIALTIES INC	22-23	BRUNNER MFG CO. INC.	33
DBA G S AEROSPACE DIVISION		DBA BRUNNER MANUFACTURING DIVISION	
B & D THREAD ROLLING	23	BRYCO MACHINE, INC.	34
B & E MACHINE SHOP & SHEET METAL FAB., INC.	23	BUCK EYE FORGE, INC.	34
B & E MANUFACTURING CO., INC	23	BUCKEYE MACHINING, INC.	34
B & G MANUFACTURING CO., INC.	23	BUFFALO PUMPS, INC.	34
B & N TOOL CO., INC.	23	SUBSIDIARY OF AMPCO-PITTSBURGH CORP.	
B & R MACHINE AND TOOL CORP	23	BULA FORGE INC	34
B F GOODRICH CO. RIVNUT ENGINEERED FATSEENERS, THE	24	BULTEN TRADING AB	35
(AERO AND DEF DIV		BURROWERS RESEARCH MACHINING, INC.	35
B G ENGINEERING, INC.	24	BUSAN INDUSTRIAL MACHINERY CO., LTD.	35
B G M FASTENER CO., INC.	24	BOLT DIVISION	
B. V. FABRIEK VAN KLINKNAGELS EN SCHROEFBOUTEN V/H	24	BUTECH PRESSURE SYSTEMS	35
SMIT		see BER-LOW MFG INC.	
BARCO ENGINEERING COMPANY, INC.	24	BUTLER, INC.	35
BARNEGAT BAY NSCC, INC.	24	C	
DBA BB NSCC, INC.		C & D MACHINE TOLL, INC.	36
BARRE PRECISION PRODUCTS INC	24	C & H MFG., INC.	36
BAS AEROSPACE LIMITED	25	C & S ENGINEERING LLC	36
BAUER & SCHAURTE KARCHER GMBH	25	C. E. MACHINE CO., INC.	36
BBC FASTENERS, INC.	25	C.E.S. MACHINE PRODUCTS, INC	36

MIL-HDBK-57E (IS)

Company Name	Page
DUNCAN ELECTRONICS & MFG. CO	56
DUNHAM PRODUCTS, INC	57
DUPONT, G.B. CO., INC. SEE AMAX L. P.	57
DUVE GmbH & CO. KG	57
DYSON CORP., THE Formerly JOS. DYSON & SONS, INC.	58
DZUS FASTENER CO., INC DBA DFCI SOLUTIONS, INC	58
E	
E. KOZAK PRECISION PRODUCTS CO.	58
E.L.R. MACHINE AND TOOL	58
EAGAN MACHINE CORP.	58
EAGLE PICHER INDUSTRIES PRECISION PRODUCTS PLANT	58
EAGLEHEAD MANUFACTURING COMPANY INC DBA DEJAK MACHINE TOOL CO. DIV DEJAK DRILLING	58
EAST COAST METALS INC.	58
EASTERN SCREW CO., INC.	59
EASTWOOD MFG., CO.	59
EATON AEROQUIP CORPORATION AEROSPACE DIVISION	59
EBC INDUSTRIES FORMERLY ERIE BOLT CORP.	59
EBERHARD BRUNINGHAUS	59
ECENARRO S. COOP. LTDA.	59
EDS ORDNANCE	59
ELASTIC STOP NUT See MACLEAN-ESNA	60
ELCO INDUSTRIES, INC.	60
ELECTRO-FREETO MANUFACTURING COMPANY	60
ELITE FASTENERS	60
ELLIS PRECISION INDUSTRIES DBA E P IND.	60
EMERALD VALLEY MFG	60
EMHART CORP GRIPCO FASTENER DIV PARKER-KALON DIVISION	61
EMP MANUFACTURING CO	61
EMPIRE PRECISION MACHINING, INC.	61
ENGEL MANUFACTURING COMPANY, INC., THE	61
ENGINEERED BOLTING PRODUCTS, INC.	61
ENGINEERING MATERIALS CO., INC FASTENER MANUFACTURING DIVISION	62
ENGLE MANUFACTURING COMPANY, INC., THE	63
ENOMOTO INDUSTRIES CO., LTD. ENOMOTO FOUNDRY	63
ERICO FASTENING SYSTEMS	63
ERIE BOLT CORP DBA EBC INDUSTRIES.	63
ESCO PRECISION, INC.	63
ESMET INC DBA ELECTROLINE TTUFLOC SUB OF UNIMET CORP	63
ESNA MACLEAN-FOGG COMPANY	64
ESP MANUFACTURING CO., INC	64
ESSENTIAL MACHINING	64
ESTA PRODUCTS COMPANY	64
EVERLOCK FASTENING SYSTEMS	64
EVERLOCK DETROIT DIVISION	64
GREER STOP NUT (Greer-Smyrna Division)	65
INTERNATIONAL SCREW DIVISION	65
EXCEL PRECISION PRODUCTS, INC.	65
EXPERIMENTAL MACHINE CO.	65
F	
FABER ENTERPRISES, INC	65
FABRICATION SPECIALTY INC.	66
FABSCO CORP.	66
FAILING CO., GEORGE E	66
FALCON MANUFACTURING CORP.	66
FALL RIVER MANUFACTURING CO., INC.	66

Company Name	Page
FANG SHENG SCREW CO., LTD.	66
FARIAS INDUSTRIAL MACHINING	66
FARLO MACHINE & TOOL CO., INC	66
FASSCO FASTENER & STEEL SUPPLY CO., LTD.	67
FASTENAL COMPANY	67
FASTENER BROKERAGE INC DBA INOFAST MANUFACTURING	67
FASTENER INNOVATION TECHNOLOGY INC DBA F.I.T.	67
FASTENER TECHNOLOGY CORP.	67
FASTENING PRODUCTS CO., INC.	67
FASTENING PRODUCTS OF LANCASTER, INC.	68
FASTENRATH BEFESTUGYBGSTECGBUJ GMBH	68
FASTI-WERK CARL AUG. FASTENRATH GMBH & CO.KG	68
FASTRON COMPANY, THE	68
FEDERAL EQUIPMENT COMPANY	68
FEDERAL MANUFACTURING CORP.	68
FEDERAL SCREW WORKS BIG RAPIDS DIV ROMULUS DIV	69
FENBAR PRECISION MACHINISTS, INC	69
FENTON HEADING	69
FERNDALE FASTENER	69
FERRIERE DI STABIO, S.A.	69
FERRY CAP & SET SCREW CO., THE	70
FIBAM COMPANHIA INDUSTRIAL	70
FILETAGE INTERNATIONAL INTERNATIONAL THREAD INC.	70
FIRST AMERICAN SALES CO.	70
FISCHER SPECIAL MFG. CO.	70
FITZ MANUFACTURING INDUSTRIES LTD DBA FMI	70
FLAIG & HOMMEL	70
FLEXALLOY INC.	71
FLORES ENTERPRISES	71
FLUIDONICS INC.	71
FLUIDYNE CORPORATION	71
FOLSOM TOOL & MOLD CORP.	71
FONTAL CONTROLS, INC.	71
FONTANA LUIGI S.p.A	72
FOREMOST PRECISION INSTRUMENT CORP.	72
FOREST FASTENERS	72
FORMED FASTENER MANUFACTURING, INC	72
FPA MANUFACTURING DBA FPA MANUFACTURING AND SUPPLY	72
FRANROE PRECISION MACHINE COMPANY	72
FREEMAN COMPANY, THE	73
FRIEDR BOESNER GMBH	73
FRISBY AEROSPACE INC DE DIV TRIUMPH ACTUATION SYSTEMS -CLEMMONS	73
FRONTIER BOLT COMPANY OF TEXAS	73
FUCHS SCHRAUBENWERK GmbH	73
G	
G & R SCEW MACHINE PRODUCTS	74
G & S MACHINE INC	74
G. B. MACHINE PRECISION, INC.	74
G.B. DUPONT CO., INC	74
GAITHER PATRICIA DBA GAITHER MACHINE	74
GALAN PRECISION MACHINE CO.	74
GALMAC MFG CO	74
GARCIA INDUSTRIES, INC	74
GARDINER MFG. CO.	75
GATES ALBERT, INC.	75
GATEWAY SCREW AND RIVET, INC.	75
GEN FAST MANUFACTURING COMPANY	75
GENERAL AVIATION	75
GENERAL MACHINE PRODUCTS, INC	75
GENERAL SCREW AND SPECIALTY CO INC	75
GERMAN MACHINED PRODUCTS, INC	75
GERTLER INDUSTRIES, INC	75
GFD LETAGE	76
GILL MACHINE TOOL CO	76

MIL-HDBK-57E (IS)

Company Name	Page	Company Name	Page
GL CNC SERVICES INC	76	HMS SERVICES LLC	87
GMJ MACHINE COMPANY, INC.	76	HO HONG WORKS CO., LTD	87
GMP CO CORPORATION	76	HOFFMANN, RICHARD GmbH	87
GOSHO WORKS, LTD.	76	HOFFMANN MACHINE COMPANY, INC.	
GRACO INDUSTRIES, INC.	77	DBA HOFFMAN, RICHARD GmbH	
GRADON SCREW MACHINE CORP.	77	HOLLYWOOD MANUFACTURING INC.	87
GRANDUER FASTENERS, INC	77	HOLO-KROME CO.	87
GRAUCH ENTERPRISES	77		
GREATER MARYLAND TOOL & MFG., CORP.	77	HORSPPOOL AND ROMINE MFG CO INC	87
GREEN BAY DROP FORGE CO	77	HORST ENGINEERING & MANUFACTURING CO.	88
DIV OF CLEVELAND HARDWARE & FORGING		HOUSTON FASTENER	88
GREENFIELD MANUFACTURING CO., INC.	78	HOUSTON PRECISION FASTENERS	88
GREER STOP NUT, INC.	78	HOWARD TOOL CO., INC.	88
GRIPCO, DIVISION OF BLACK & DECKER	78	HOWE MACHINE AND TOOL CORP.	88
GROOV-PIN CORPORATION	79	HOWELL PRECISION, INC.	88
GRUPO RASSINI S.A. DE C.A.	79	HOWIE MANUFACTURING CO., INC.	88
RASSINI INTERNATIONAL, INC.		HUCK AEROSPACE PRODUCTS	89
GS AEROSPACE	79	HUCK INDUSTRIAL PRODUCTS	89
DIVISION OF B & B SPECIALTIES INC		HUCK PRODUCTS	89
GSF FASTENING	79	HUGGINS MFG	89
ARMSTRONG FASTENING LTD.		HUGO DURHOLT GMBH & CO. KG	89
GUARDIAN RIVET & FASTENER	80	HUNT VALVE COMPANY INC	89
GUARDIAN MFG. DIVISION		DBA WAECO VALVE DIVISION	
GUNNISON-INTERNATIONAL INC.	80	HUNTER-STEVENS CO INC	89
		HUNTINGTON VALLEY INDUSTRIES, INC DBA HVI	89
H		HURON AUTOMATIC SCREW CO.	90
H C MERCHANDISERS INC	80	HURRICANE MACHINE COMPANY, L.L.C.	90
DBA H C PACIFIC		HYDRO FITTING MANUFACTURING CORPORATION	90
H C PACIFIC	80	HYDROBOLT LIMITED	90
H. MULLINS, LTD.	80		
BADE INDUSTRIAL ESTATE		I	
H. PAULIN & CO. LTD.	80	I.G.D. MACHINE & TOOL LTD.	90
CAPITAL METAL INDUSTRIES DIVISION		IDEAL FASTENERS INC.	90
H. PRINZ GmbH FABRIK FUR VERBINDUNGSELEMENTE	80	IFASTGROUPE 2004 LP	90
HABINA ENGINEERING	81	see INFASCO	
HALL INDUSTRIES INC.	81	see INFASCO NUT DIV	
FORMERLY STANDARD TOOL & MACHINE COMPANY		see INGERSOLL FASTENERS	
HALLSIMS INDUSTRIAL COMPONENTS, INC.	81	IMPERIAL SUPPLIES LLC	91
HAMANAKA (THAILAND). CO., LTD	81	INDIANA AIRCRAFT HARDWARE INC	91
HAMANAKA NUT MFG. CO., LTD		INDUSTRIAL & AUTOMOTIVE FASTENERS	91
HANDI GADGETS CORP.	81	DIVISION OF KEY MANUFACTURING GROUP, INC.	
HANSAN SCREW CO., LTD.	81	INDUSTRIAL FASTENERS CORP.	92
EXPORTING DEPARTMENT		INDUSTRIAL FORGE, INC.	92
HARDWARE SPECIALTY CO, INC	82	INDUSTRIAL NUT CORP.	92
HARRISON BOLT AND NUT CO., THE	82	INDUX, S.A DE C.V.	92
HARTFORD AIRCRAFT PRODUCTS, INC.	82	INFASCO	92
HARWOOD DESIGN, INC.	82	DIV OF IFASTGROUPE 2004 LP	
HASKELL OF HUNTINGTON, INC.	82	INFASCO NUT DIV	92
HASSALL, JOHN, INC.	82	DIV OF INFASTGROUPE 2004 LP	
HATCH INDUSTRIES	83	INGERSOLL	93
HAWTHORNE BOLT WORKS	83	DIV OF IFASTGROUPE LP, A HEICO COMPANY	
HAYDON BOLTS, INC.	83	INLAND MACHINE CO.	93
HAZE SEIKO CO., LTD	83	INOFAS MANUFACTURING INC.	93
HEARTLAND PRECISION FASTENERS INC	83	IN-SPECK CORP.	93
HEIM'S MACHINE AND TOOL INC.	83	INSTRUMENT MACHINING SERVICE LTD.	93
HEITCO MANUFACTURING, INC.	84	INTERFLEX MFG. CORP.	93
HEMCO TOOL INC	84	INTERSTATE FITTINGS INC.	93
HENWAY, INC.	84	IRVING MACHINE SERVICE, INC.	93
HEPTNER MANUFACTURING COMPANY	84	IRWIN AUTOMATION, INC.	94
HESSISCHE SCHRAUBENFABRIK WELTER GmbH & CO., KG	84	ISLAND ENGINEERING DBA J SMITH MACHINE SHOP INC	94
HEWINS, EDMOND, C. JR.	84	ITT HARPER AEROSPACE FASTENER OPERATIONS	94
HEXAGON ENTERPRISES, INC	84	AEROSPACE CONTROLS DIVISION	
HI INDUSTRIAL TECHNOLOGIES	84	ITW BUILD EX	94
HIGH QUALITY MACHINE SHOP INC	84	ITW CIP	94
HIGH TECH ENTERPRISES	85	IVACO INC	95
HIGHLAND PRODUCTS CORPORATION	85	DBA INFASCO see IFASTGROUPE 2004 LP	
HIGHLAND THREADS, INC.	85		
FASTENER MANUFACTURING DIVISION		J	
HILL AEROSPACE & DEFENSE LLC	85	J & M MACHINE INC	95
HILL FASTENER CORP.	85	J & S PRECISION FASTENERS	95
HILL STAMPING & MANUFACTURING INC	85	J. G. FASTENERS	95
HILTI, INC	86	J. GEORG BIERBACH	95
HI-SHEAR CORP.	86	J.M. PRECISION, INC.	95
DBA FOREIGN PARENT IS LISI PARIS FRANCE		J.P. PRODUCTS, INC.	96
HLC INDUSTRIES INC	86	DBA SPECIALITES, UNLIMITED	

MIL-HDBK-57E (IS)

Company Name	Page	Company Name	Page
JACOBSON MFG. LLC.	96	L & M ENTERPRISES INC	104
JACO ENGINEERING, INC.	96	L A MARTIN COMPANY	104
JAM TECH CORP.	96	L G MACHINE AND MFG INC	104
JAMES JACKSON	96	L H INDUSTRIES, INC.	104
DBA J J ENGINEERING		TIP TOP TOOL CO.	
JAMISON INDUSTRIES INC	96	L N AEROSPACE, INC	104
JAY BEE MACHINE WORKS, INC.	96	L P R PRECISION PARTS AND TOOL CO INC	104
JAY O MACHINE CO., INC.	96	L R G CORPORATION	104
JAYCO ENGINEERING	96	LAKE ERIE PRODUCTS, INC.	105
JERGENS INC	97	LAMSON AND SESSIONS OF CANADA LTD.	105
DBA JERGENS INDUSTRIAL SUPPLY		RB & W CORP. METAL FORMING DIVISION	
JET MACHINE WORKS COMPANY	84	LANA INDUSTRIES	106
SEE HEWINS, EDMOND, C. JR		LANARKSHIRE BOLT LTD.	106
JJ ENGINEERING	97	LAND-SEA-AIR MACHINED PRODUCTS INC	106
JAMES JACKSON		LANIS MACHINE AND MFG CO	106
JJ SCREW PRODUCTS, INC.	97	LANUM METAL PRODUCTS LLC	106
JMT MACHINE COMPANY	97	LBL PRODUCTS	106
JOLICO/J-B TOOL INC.	97	LEBRECHT TIGGES GmbH & CO. KG	106
JOSLYN CORP.	97	LELAND-POWELL FASTENERS, INC.	107
JUPITER WASHERS, INC.	97	LENCH, THOMAS WILLIAM, LTD	107
JUST IN TIME INC	98	LENTERN AIRCRAFT LTD.	107
DBA APSCO		LEONARD JED CO	107 - 108
		MARYLAND BOLT AND NUT CO DIV	
K		LEVEL 1 FASTENERS	108
K & K PRECISION ENTERPRISES INC	98	LEVINGSTON MACHINE COMPANY	109
K.A.A. COMPANY	98	LEWIS SCREW CO	109
LYNN ABADIE DBA K A A COMPANY		DIV OF MEDALIST FASTENERS INC	
K.D.K. UPSET FORGING C O. INC.	98	LFC INDUSTRIES	109
KAMAX - WERKE RUDOLF KELLERMANN GMBH	98	DIVISION RKR TECHNOLOGIES	
KAMAX L. P.	98	LINREAD NORTHBRIDGE	109
FORMERLY G.B. DUPONT CO., INC.		LEICESTER, UK	
KAMPWERK VIIEGGE U. PICKARDT GMBH. & CO	98	LINREAD NORTHBRIDGE AIRCRAFT PRODUCT DIVISION	109
KAPCO INDUSTRIES, INC	99	LINREAD PUBLIC LIMITED CO.	110
KATSURAGAWA MACHINE SCREW CO., LTD.	99	AIRCRAFT PRODUCTS DIVISION	
KAYGOR, INC.	99	LIPPISCHE EISENINDUSTRIE GmbH	111
KAYNAR PRODUCTS	99		
KELLER ENGINEERING CO	99	LISI AEROSPACE	111 - 112
KELOX/MICRODOT PRODUCTS	99	A1 TECHNOLOGIES	
KEN FORGING, INC.	100	BLANC AERO INDUSTRIES	
KERR CHARLES W	100	BLANC AERO INDUSTRIES RUGBY	
KERR LAKESIDE INC.	100	BLANC AERO SAINT CHAMOND GRANAT	
KEYSTONE BOLT & NUT COMPANY	100	BLANC AERO TECHNOLOGIES	
KEYSTONE THREADED PRODUCTS DIVISION		DECOLLETAGE GENERAL MODERNE	
KEYSTONE TOOL AND MACHINE CO	100	FT BESTAS	
KILBOURN ENGINEERING CO.	100	HI-SHEAR CORPORATION	
KIRSTEN PIPE CO. INC.	101	LISI AEROSPACE CANADA	
KLINCHER LOCKNUT CORP.	101	MONADNOCK COMPANY THE	
K.L.M. MACHINE INC.	101	LITTLE WORLD MFG INC	113
KNIPPING-DORN GmbH KALTUMFORMTECHNIK	101	LLOYD MACHINE & TOOL CO., INC.	113
KNOCH MANUFACTURING CO. LTD	101	LN AEROSPACE, INC	113
KO AMS MACHINE PRODUCTS	101	LOBO OFFICINE MECCANICHE SPA	113
DBA KOAM MACHINE		LOBO SYSTEMS LTD	113
KOBE FASTENER LIMITED	101	LONE STAR FASTENERS, LP	113
KOLB GMBH & CO. HERSTELLER VON	101	FORMALLY LONE STAR SCREW CO OF TEXAS INC	
VERBINDUNGSELEMENTEN		LONG-LOK FASTENERS CORP.	113
KONDOR TECHNOLOGIES, INC.	102	LOOS & CO., INC.	114
KONGO BYORA CO., LTD.	102	AEROSPACE FASTENERS DIVISION	
KOREA BOLT IND. CO., LTD.	102	LORD CORPORATION	114
FOREIGN TRADE DEPARTMENT		AEROSPACE PRODUCTS DIVISION	
KORODY-COLYER CORP A CR INDUSTRIES CO	102	(PLANT) DBA MECHANICAL PRODUCTS DIVISION	
KOZAK, E. PERCISION PRODUCTS CO	102	LOUGHLIN MANUFACTURING CORP	114
KPF	102		
KREIS TOOL & MANUFACTURING CO INC	102	M	
KROBACH MANUFACTURING CORP.	103	M & M MANUFACTURING CORPORATION	114
KSS SOCKET SCREW, INC	103	M.A.A. CORP.	114
K-TECH MFG., INC.	103	MID AMERICA AEROSPACE DIVISION	
KYOEI SEISAKUSHO CO., LTD.	103	M.L.W. MANUFACTURING CO.	114
KYOKUTO MFG CO LTD	103	M.S. AEROSPACE	114
		MAC FASTENERS, INC.	115
L		MACHINE SHOP, INC., THE	115
L & C MFG CO INC	103	MACHINERITE CORP.	115
L & H THREADED RODS	104	MACK A W MFG COMPANY INC	115
DIV OF GRAY AMERICA CORP		MACKO INDUSTRIES	115
L & J FASTENERS, INC.	104	MACKSON MFG CORP	115
		MACLEAN-ESNA	116
		MACLEAN-FOGG CO.	
		MACLEAN-FOGG CO.	116

MIL-HDBK-57E (IS)

Company Name	Page
MACOR, INC.	117
MAGNUM MACHINE SHOP	117
MAGNUS TOOL & DIE CO., INC.	117
MAILLY MFG CO., INC.	117
MAIN MACHINE CO INC	117
DBA MAIN MACHINE & TOOL CO	
MANNO, RICHARD & CO., INC	117
MANUFACTURING ENGINEERING TECH.	117
MANUFACTURING SALES AND SERVICE	117
MANUFACTURING TECHNOLOGY SERVICES	118
MAPECO PRODUCTS, INC.	118
MAR-BRO MFG., INC.	118
MARTIN-CHANDLER, INC	118
MARUYKO NUT CO., LTD.	118
MARVIN ENGINEERING, CO., INC.	118
MARYLAND BOLT & NUT CO., INC.	119 - 120
LEONARD JED CO	
MASTER RESEARCH & MFG., INC.	120
MASTERCRAFT TOOL COMPANY	120
MAUDLE INDUSTRIAL CO., LTD.	120
MAUI MEGA	120
DBA KERR, CHARLES W	
MCADAMS MACHINE AND TOOL CO INC	120
MCCULLOUGH AERO CO	121
DBA MCCULLOUGH & ASSOCIATES	
MCLANE MFG INC	121
McMELLON BROS INC.	121
MD3 INDUSTRIES LTD	121
DBA EMPIRE PRECISION MACHINING	
MEACO PRODUCTS CORP.	121
MEC WOLF SRL	121
MECAERO PRODUCTS	122
MECAERO CANADA INC.	122
MECAIR AEROSPACE INDUSTRIES	122
SUBSIDIARY OF SPS TECHNOLOGIES DIV	
DBA MECAIR INC	
MECHANICAL AND INDUSTRIAL FASTENERS	122
MECHANICAL INDUSTRIES LLC	122
MEL-BA MANUFACTURING INC	122
MERCER PRODUCTS & MFG. CO., INC.	123
MERCURY AEROSPACE FASTENERS INC	123
LISI AEROSPACE	
MERCURY TOOL & MACHINE, INC.	123
METALCRAFTERS	123
DIVISION OF KEYSTONE CONSOLIDATED INDUSTRIES	
METAL-TECH MFG. INC.	123
METHODS AND MACHINING SERVICES INC.	123
METRO TOOL AND MANUFACTURING CO.	124
ALEXANDER MANUFACTURING COMPANY INC	
METRIX MFG. CO.	124
MI. ME. AF. S.r.l.	124
MICRO SCREW MACHINE PRODUCTS, INC.	124
MICRODOT INC.	124
MICRODOT AEROSPACE FASTENING SYSTEMS GROUP	
ADVANCED PRODUCTS DIV	
MICRODOT INSERTS DIVISION	
KAYNAR MFG. DIVISION	
MID CONTINENT SCREW PRODUCTS CO.	125
MID-STATES SCREW CORP.	125
ILLINOIS CORPORATION	
MIDWEST ACORN NUT CO.	125
MILE-HI MACHINE, INC.	125
MILLIPART, INC.	125
MILLS, J. R. MACHINING, INC	125
MIL-SPEC FASTENERS CORP.	125
MINEBEA CO LTD	126
FUJISAWA MANUFACTURING UNIT	
MIROFINE COMPANY	126
MI-TECH, INC.	126
MITSUBOSHI INDUSTRIES, LTD.	126
OSAKA DIVISION	
MIX TOOL CO.	126
MKM MACHINE TOOL CO INC	127
M-MANUFACTURING	127
MMG ENGINEERED COMPONENTS INC	127
DBA TOOLSOURCE	
MNP CORPORATION	128

Company Name	Page
DBA MNP CORPORATION DIVISION 2	
DBA MNP CORPORATION DIVISION 4	
DBA MNP FASTENER DIVISION	
MODERN METRIC MACHINE COMPANY INC	128
MODFORM-ILLINOIS INC	128
MONADNOCK COMPANY THE	128
DBA LISI AEROSPACE	
MONOGRAM AEROSPACE FASTENERS	129
MONROE MACHINED PRODUCTS INC	129
MONTEREY MACHINE PRODUCTS	129
MORTON FASTENERS INC.	129
MORTON MANUFACTURING	129
DIVISION MORTON GRINDING	
MOSTAR GEAR & MACHINE MFG., CO.	129
MOTOR WHEEL CORP.	130
MRL MANUFACTURING CORP	130
N	
N.S.S. INDUSTRIES	130
NAFCO INDUSTRIES, INC.	130
NAGOYA SCREW MANUFACTURING CO, LTD	130
NAPIER AUTO BODY	130
NARRAGANSETT SCREW MFG CO	131
NASSAN TOOL WORKS, INC.	131
NASU DENKI-TEKKO CO., LTD.	131
NATIONAL BOLTS AND RIVETS LTD	131
NATIONAL FASTENER CO., LTD.	131
NATIONAL THREADED FASTENERS CORP.	131
NAVPAR, INC.	131
NC AUTOMATED INDUSTRIES INC	132
NCMI BRUEGGEMANN INC	132
ND INDUSTRIES INC	132
DBA ND WESTERN FASTENER PROCESSING DIVISION	
NEDSCHROEF HALMOND B.V.	132
NEKG HOLDINGS	132
NELSON AEROSPACE INC.	132
NELSON STUD WELDING DIVISION	133
NEUMAYER, ERICH GMBH & CO.KG	133
NEVADA BOLT AND MFG CO INC	133
DBA SPS NON-FERROUS ENGINEERED FASTENERS	
NEVILLE MACHINE SHOP	133
NEW HORIZON MACHINE CO., INC.	133
NICE TOOL MFG., INC.	133
NIPPON MACHINE ENGINEERING, INC.	134
NIPPON STEEL BOLTEN CO., LTD.	134
NISCO, INC.	134
NISSAN SCREW CO. LTD.	134
SALES DEPT., FOREIGN TRADE SECTION	
NOCHIA STEELWORKS	134
NON-FERROUS BOLT & MANUFACTURNG CO.	134
NORTHBRIDGE FASTENERS	135
NORTHEAST FASTENERS	135
NORTHEAST METAL CO., INC.	135
NORTHERN SCREW CO., INC.	135
NORTHSTAR ENGINEERING	135
NOVA MACHINE PRODUCTS, INC.	136
A SUBSIDIARY OF CURTIS-WRIGHT FLOW CONTROL SERVICE CORP.)	
NT ENGINEERING INC	136
NUCOR FASTENER DIVISION (DIVISION OF NUCOR CORPORATION)	136
NUMERIC MACHINE PRODUCTS	136
NUTS INCORPORATED	136
DIVISION OF STANLOK	
NUTS, INC.	136
NYLOK CORP.	137
O	
OAKTREE FASTENERS CO.	137
OBARS MACHINE & TOOL CO.	137
OCM MACHINE COMPANY, INC.	137
OHIO NUT & BOLT CO., THE	137
DIV. OF FASTENERS INDUSTRIES, INC.	
OHKAWA SCREW MFG. CO., LTD	138

MIL-HDBK-57E (IS)

Company Name	Page
OKABE CO., INC.	138
OKABE KIKO CO., LTD.	
OKAI IRON WORKS, INC	138
OKAWA SCREW MANUFACTURING CO., LTD	138
OMEGA THREAD ROLLING AND GRINDING INC.	138
ONEIDA TOOL & MACHINE CORP.	138
ONO MANUFACTURER, INC.	139
ONO MANUFACTURING CO., LTD	
ONTIC ENGINEERING & MANUFACTURING, INC.	139
ORANGE PRECISION PARTS	139
ORC-O TOOL & MACHINE, INC.	139
ORDNANCE PARTS & ENGINEERING CO.	139
ORLOTRONICS CORP.	139
OSAKA SEIKI CO., LTD.	139
OSTEEN MACHINE SHOP	140
OTO MELARA S.p.A.	140
FINKECCANICA COMPANY	
OTT BROTHERS MACHINE CO., INC.	140
OWARI PRECISE PRODUCTS CO., LTD	140

P

P & I ASSOCIATES, INC.	140
P & L ENTERPRISES	140
P.C.M., INC.	140
P.S. MACHINE CO., INC.	141
PABCOR, INC.	141
PACER ALLOYS, INC.	141
PACIFIC FASTENERS, INC.	141
PACIFIC SCIENTIFIC	141
PACIFIC TOOL, INC.	141
PADGETT MACHINE INC.	141
PAINTER TOOL, INC.	141
PALNUT CO., THE	142
UNITED CARR FASTENERS PALNUT DIV	
PARK PRECISION CORPORATION	142
PATEREX, LTD	142
PATTERSON LAKE PRODUCTS	142
SUBSIDIARY OF COLUMBIA AUTO PARTS	
PAULIN H AND CO LTD	142
PB FASTENERS	142
DIVISION OF PAUL R. BRILES, INC.	
PEERLESS SCREW PRODUCTS CORP.	142
PEINER UMFORMTECHNIK GmbH	143
PELHAM AUTO MATRIX PRECISION	143
PENN CIGAR MACHINES INC	143
PEM INC	
PENNENGINEERING AUTOMOTIVE FASTENERS	143
PENN ENGINEERING & MANUFACTURING CORP.	143
ATLAS ENGINEERING INC.	
PENN SCREW & MACHINE WORKS, INC.	144
PEREZ MACHINE, INC.	144
PERIGEE MANUFACTURING COMPANY, INC.	144
MICHIGAN CORPORATION	
PERKINS MACHINE CO.	144
PHOENIX SPECIALTY MANUFACTURING CO., INC.	144
PILGRIM SCREW CORPORATION	144
PINE TAVERN MACHINE INC.	145
PINEY RIDGE CO.	145
PINTO PRODUCTS	145
PIONEER MACHINE PRODUCTS, INC.	145
PIONEER SCREW & NUT CO.	145
PLAINVILLE MANUFACTURING CO., INC.	145
PNEU-HYDRO PRODUCTS, INC.	145
POINT MACHINE COMPANY	145
POLYTECHNIC INDUSTRIES	146
PORTLAND BOLT & MANUFACTURING CO INC	146
PORTSMOUTH NAVAL SHIPYARD	146
POWERPARTS, INC.	146
PRD FASTENERS LTD	146
PRECI-MANUFACTURING, INC.	146
PRECISE AERO PRODUCTS	146
PRECISE OF CALIFORNIA	147
DIV OF ADJUSTABLE BUSHING CORP	
PRECISION AIRCRAFT MACHINING CO., INC. DBA PAMCO	147

Company Name **Page**

PRECISION METAL PRODUCTS CO.	147
PRECISION PARTS & TOOL CO., INC.	147
PRECISION PIECE PARTS, INC	147
PRECISION SCREW & BOLT, INC.	147
PRECISION TECHNOLOGIES, INC.	147
PRECISIONMATICS CO., INC	148
PREM INDUSTRIES, INC.	148
PRICE MANUFACTURING CO.	148
PRIETO MACHINE COMPANY, INC	148
PRODUCT DEVELOPMENT GROUP, INC.	148
PRODUCTION & TOOL COMPANY	148
PRODUCTS DESIGN & MFG. CORP.	149
PRO-MACHINE & TOOL COMPANY	149
PROMPTUS ELECTRONIC HARDWARE	149
PROTO MACHINE CO., INC.	149
PTM INTERNATIONAL INC	149
PURITAS METAL PRODUCTS, INC.	149
PYE & HOGAN LLC	149

Q

QRP, INC.	149
QSN MANUFACTURING, INC.	150
QUALITY AIRCRAFT SCREWS, INC	150
QUALITY FABRICATIONS, INC.	150
QUALITY MACHINE & MFG INC	150
QUALITY SCREW PRODUCTS, INC.	150
QUALITY SOCKET SCREW MANUFACTURING CORP.	150
QUALITY THREADED PRODUCTS COMPANY	150

R

R & D FASTENERS	151
R & D WELDING & MACHINE INC.	151
R & I ENTERPRISES, DBA COMPUTOLOGIC DESIGN CO	151
R & R PRECISION	151
R B & W CORPORATION	151 - 152
R. BILD COMPANY, INC	152
R.E.C. CORP.	152
RABOURDIN	152
RADAX INDUSTRIES, INC.	152
RAE MANUFACTURING CO.	153
RAHMEDE SCHRAUBENFABRIK	153
RAINBOW MACHINE PRODUCTS, INC.	153
RAM ENTERPRISES	153
RAM PRODUCTS	153
RAM THREADING, INC.	153
RAMAR NUTS, INC.	153
RAMCO SPECIALTIES, INC.	154
RAMM DEFENSE PRODUCTS	154
RATHMANN WALTER G. SEGMENT-KLAMMERSCHRAUBEN	154
GMBH	
RA-WHITE, INC	154
RB & W CORP.	154
REED INSTRUMENT CO.	155
REGAL AIR, INC	155
REID PRODUCTS INC.	155
RELIENT FASTENER	155
REPUBLIC FASTENER MANUFACTURING CORP.	155
REXNORD	155
SPECIALITY FASTENERS DIVISION	
RICHARD MFG. CO., INC.	155
RICNO TECHNOLOGIES, INC.	156
RING SCREW WORKS	156
RING SCREW DIVISION	
FENTON HEADING DIV.	
FRENDALE FASTENER	
SEMCO FASTENER DIV	
TITAN FASTENER	
RIPPA PRODUCTS	156
RISCO, INCORPORATED	156
RIVER VALLEY TOOL & MANUFACTURING	156
RIVNUT ENGINEERED PRODUCTS, INC.	157
RMS	157
ROBBINS MANUFACTURING CO., INC.	157

MIL-HDBK-57E (IS)

Company Name	Page
SPECIAL FASTENER DIVISION	
THIANT (BOULONNERIE DE SA)	179
THOMAS & BETTS CORPORATION FORMERLY AMERICAN ELECTRIC	179
THOMAS INSTRUMENT & MACHINE CO., INC.	179
THOMAS MACHINING TECHNOLOGIES, INC.	179
THOMAS MFG, INC.	180
TITAN FASTENER	180
TOG MANUFACTURING CO., INC.	180
TOKOSHA METAL WORKS LTD.	180
TONG HWEI ENTERPRISE CO., LTD.	180
TOOLEX, INC	180
TOPURA CO., LTD.	180
TORCO, INC.	181
TORONTO FASTENERS INDUSTRIES, INC. SUBSIDIARY OF HI-SHEAR CORP., USA	181
TORX PRODUCTS CAMCAR DIV/TEXTRON INC.	181
TOWNE ROBINSON FASTENER CO. KEY MANUFACTURING GROUP, INC.	181
TOWNSEND CO. CERRY RIVET DIVISION	181
TOYO STEEL WIRE CO., LTD.	181
TRI STATE TOOL & DIE CO., INC.	182
TRIAD PRODUCTS CORP.	182
TRIDAIR PRODUCTS	182
TRIDENT MACHINE CO.	182
TRIUMPH GROUP OPERATIONS INC, THE FRISBY AEROSPACE INC DE	182
TRIUMPH MANUFACTURING CO., INC.	182
TRONSON MANUFACTURING	182
TROY D. RAY DBA DIXON MACHINE & FABRICATION	182
TRW FASTENER DIVISION	183
TRY - AZTEC COMPANY	183
TUFF FASTENERS CO.	183
TURNAMICS, INC.	183
TW DESIGN AND MANUFACTURING, L.L.C.	183
TWIST TITE MFG. INC.	183
U	
U.P. MACHINE & ENGINEERING CO.	184
U.S. BOLT MANUFACTURING, INC.	184
ULTIMATE MACHINING & WELDING	184
ULTRA SONIC MACHINE CO., INC	184
UMPCO CORP.	184
UNIFLOW CORP.	184
UNIMETERIC CORPORATION	185
UNISTRUT CORP. (UNISTRUT PHILA)	185
UNITED BOLT & SCREW CORP.	185
UNITED DRILL BUSHING CORP	185
UNITED PRECISION PRODUCTS CO., INC.	185
UNITED STATES DEFENSE RESEARCH & SUPPLY	185
UNITED STEEL & FASTENERS INC.	186
UNIVERSAL MACHINE PRODUCTS	186
UPB ENGINEERING	186
URANIA ENGINEERING CO., INC. SPEC-NUT	186
URBAN MANUFACTURING CO.	186
URBAN MFG. CO. INC.	186
US TOOL & DIE	187
UTAH TOOL & DIE, INC.	187
V	
VALCOR ENGINEERING CORP.	187
VALLEY FORGE AND BOLT MFG CO	187
VALLEY-TODECO, INC.	187
VAN PETTY MFG., INC. DBA J.W. MANUFACTURING INC	187
V-B MACHINE CO., INC. FASTENER DIVISION	187
VEGAS FASTENER MANUFACTURING	187

Company Name	Page
VENUS FASTENERS CORP.	188
VERSATECH, INC.	188
VERTEX DISTRIBUTION	188
VICO PRODUCTS, CO.	188
VICTOR PRODUCTS CORP.	188
VIP MFG. & ENGR. CORP.	188
VISSERIES & BOULONNERIES DE FOURMIES	188
VISTEK INDUSTRIES	189
VITCO NUCLEAR PRODUCTS INC.	189
VM MANUFACTURING CORPORATION	189
VMC INDUSTRIES, INC.	189 - 190
VOI-SHAN PRODUCTS	191
VOSS INDUSTRIES, INC.	191
VOSS AEROSPACE DIVISION	
VSI (AEROSPACE PRODUCTS DIVISION)	191
VULCAN RIVET & BOLT CORP.	191
W	
WALKER BOLT MANUFACTURING DIVISION OF LONE STAR FASTENERS, LP	191
WALZ & KRENZER INC DBA MAPECO PRODUCTS DIV MAPECO PRODUCTS	192
WARREN PUMPS LLC DIVISION OF COLFAX CORPORATION	192
WATERBURY BUCKLE CO.	192
WAYNE BOLT & NUT CO., INC.	192
WEAVER MANUFACTURING, INC.	192
WEBLUK MACHINE CORP.	192
WELTER GMBH & CO. KG	192
WELTON ROLLED THREAD CORP.	192
WESLOK DIVISION OF FALL RIVER MANUFACTURING	193
WEST COAST AEROSPACE, INC.	193
WEST TENNESSEE LIONS BLIND INDUSTRIES INC DBA A P MILLS INDUSTRIES FOR THE BLIND	193
WESTERN PACIFIC ENTERPRISES, W.P.E., INC.	193
WESTERN SCREW MACHINE PRODUCTS, INC CUTTING EDGE MACHINING	193
WESTERN SKY INDUSTRIES, INC. DIVISION OF ATLAS CORP.	193
WESTFIELD FASTENERS	194
WESTLAND STEEL PRODUCTS, LTD.	194
WESTWOOD PRECISION, INC.	194
WHAIL BOLT IND. CO., LTD	194
WHELAN MACHINE & TOOL CO	194
WHITNEY SCREW CORP.	194
WHITTET-HIGGINS CO.	194
WIGLEY MACHINE COMPANY	194
WILHELM SCHUMACHER SCHRAUBEN-FABRIK GmbH	195
WILLIAM'S MACHINE & FABRICATION, INC.	195
WIL-NIC E D R INDUSTRIES INC DBA WIL-NICO	195
WILSON-GARNER CO.	195
WILT PRECISION PRODUCTS	195
WINKER HERMANN GMBH & CO KG METALLWARENFABRIK	195
WINSLOW AUTOMATICS, INC	196
WODIN, INC.	196
WOLSTENHOLME MACHINE DBA WM ROBOTS	196
WOLTERS GMBH	196
WOLVERINE MACHINE PRODUCTS CO.	196
WOLVERINE NUT CO.	197
WORTHHEY MACHINE	197
WROUGHT WASHER MANUFACTURING INC.	197
WYANDOTTE INDUSTRIES, INC.	197
WYNNSON ENTERPRISES, INC.	197
X	
XCEL MFG., INC	197
Y	
Y2K MACHINE SHOP, INC.	197
YATES TOOL, INC.	198















<u>Company Name</u>	<u>Page</u>
YOUNG ENGINEERS INC, THE	198
YOW MENG INDUSTRIAL CO., LTD.	198















Z

Z & B GENERAL MACHINE	198
ZAMON CO., INC.	198
ZENEX CORPORATION	198
ZERO PRODUCTS, INC.	198

MIL-HDBK-57E (IS)

INDEX B - SYMBOL

SYMBOL	COMPANY NAME	PAGE
A		
A-1	A-1 NUT AND BOLT CO, INC	2
A-1	A-1 THREAD ROLLING CO., INC	2
	ALCO MACHINE CO.	11
A325	COAE BOLTS WORKS CO., LTD.	49
A+	ACCURATE TOOL CO., INC	4
A	AAP ACQUISITION CORP	2
A	ACCURATE PRECISION FASTENERS, INC.	3
A	ACHILLES AEROSPACE PRODUCTS, INC.	4
	ACME MACHINE PRODUCT	5
	ACME SCREW COMPANY	5
	ADAMS, EARL M. CO.	6
A	ADVANCED CNC MANUFACTURING	6
a	ADVANCED MACHINING & FABRICATING, INC.	6
a	ADVANCED PLASTICS, INC.	6
A	AEROFAST SUPPLY	8
A	AEROSPACE PRODUCTS, INC.	9
	AEROSTAR FASTENER CORP.	9
A*	AEROWIND CORPORATION	9
	AFI INDUSTRIES, INC.	10
	AIR INDUSTRIES CORPORATION	10
	AIRCRAFT FUELSEAL FASTENERS, INC.	10
	ALLIED NUT & BOLT CO., INC.	12
	ALPHA MACHINING PRODUCTS & DEVELOPMENT	13
A	ALPS SEIKO CO.	14
	AMANDA BENT BOLT CO.	14
	AMERICAN ELECTRIC and THOMAS & BETTS CORPORATION	14, 179
	AMERICAN INTERNATIONAL AERO MFG INC	15
	ANDERSON FORGE & MACHINE	16
	A-ONE MACHINE COMPANY	16
A	ARNOLD UMFORMTECHNIK GMBH & CO. KG	18

SYMBOL	COMPANY NAME	PAGE
	ARROW SCREW & MACHINE WORKS	19
A	ASAI TEKKO CO. LTD	19
	ASSOCIATED TOOL CO., INC	20
A	BELL FASTENERS	27
A	CAMCAR DIVISION OF TEXTRON INC.	39
	EATON AEROQUIP CORPORATION	59
	GARCIA INDUSTRIES, INC.	74
A	MECAERO ALCOA FASTENING SYSTEMS TOUL SE	122
A	PORTSMOUTH NAVAL SHIPYARD	146
AAP	AVIBANK MFG., INC.	22
AB	ABSCOA INDUSTRIES	3
AB 	ADJUSTABLE BUSHING CORP	6
AB	AVIBANK MFG., INC.	22
	LENCH, THOMAS WILLIAM, LTD.	107
	PRECISE OF CALIFORNIA	147
ABC	ALPHA BOLT CO.	13
ABE	ADAMS INDUSTRIES, INC.	5
ABM	AEROBOLT MANUFACTURING, INC	7
	AUTO BOLT AND NUT CO.	20
	ACE PRECISION INDUSTRIES, INC.	4
ACI	ACI	5
	ACIMET MFG.	5
	ACCU-TECH MANUFACTURING AND SUPPORT, INC	4
AD	ADOM ENGINEERING	6
AD	AUTOMATIC SCREW MACHINE PRODUCTS CO.	21
ADB	AVIBANK MFG., INC.	22
ADBB	AVIBANK MFG., INC.	22
adm	ADOM ENGINEERING	6
	AERO DYNAMIC MACHINING, INC	7
ADP	AVIBANK MFG., INC.	22
adc 	ADC COMMUNICATIONS CORP	6
AE	A & E MACHINED PRODUCTS	1
	AASTRO ENGINEERING	2

MIL-HDBK-57E (IS)

SYMBOL	COMPANY NAME	PAGE
	AERO ENGINEERING AND MANUFACTURING CO. OF CALIFORNIA	7
	ATLAS ENGINEERING, INC. and PENN ENGINEERING & MANUFACTURING CO.	20, 143
AEP AEP	AIRCRAFT ENGINEERING PRODUCTS, INC.	10
	AERO BUSHING AND COMPONENT	7
	ACCUFORM, INC.	3
	ACCURATE THREADED FASTENERS, INC	3
AF	ACUFAST AIRCRAFT PRODUCTS	5
	AEROTECH FASTENERS, INC	9
	AKKO FASTENER, INC.	11
	ALLFAST FASTENING SYSTEMS, INC.	12
	ALPHA FASTENERS	13
	ATF, INC.	20
	AUGUST FRIEDBERG GMBH	20
	AFAB PRECISION MACHINING	9
	AIRFASCO, INC.	11
	AMERICAN FASTENER & SPECIALTY CO.	15
AGC	ACE GRINDING & MFG. OF TEXAS	4
AGM	ACE GRINDING & MFG. OF TEXAS	4
A/I	ARVAN, INC.	19
A-I	AVIBANK MFG., INC.	22
	AIR-COM, INC.	10
AK	ARNOLD KNIPPING GmbH	18
A-K	AVIBANK MFG., INC.	22
A.L.	S.A.B.A. S.p.A. BULLONERIA E. AFFINI	160
	ALPINE MACHINE & TOOL CORP.	14
	A & M AEROSPACE, INC.	1
AM	AEROSPACE MANUFACTURING AMACON CORP.	8
	AMERICAN FASTENER & SPECIALTY CO.	15
	AMMAC, INC.	16
	ARDOR MFG. INC.	17
	AUTOMATIC MANUFACTURING COMPANY	21

















SYMBOL	COMPANY NAME	PAGE
AM	AUTOMATED MANUFACTURING	21
	AUTOMATIC MACHINING AND MFG CO	21
AMATOM	AMATOM ELECTRONIC HARDWARE	14
AMB	AMERICAN METAL BEARING COMPANY	15
AMC	ALBAR MACHINE CORPORATION	11
	SAI INDUSTRIES CORP. EFT 2	161
	ALARD MACHINE PRODUCTS	11
	AERO MECHANICAL FASTENING SYSTEMS	7
AMS	AEROSPACE MARINE SPECIALTY FASTENERS & FITTINGS INC.	8
AMSCO	ACCURATE SCREW MACHINE CO	3
AMT - I AMT xxxxx-xxxx	ALPINE MACHINE & TOOL CORP.	14
A-N	AVIBANK MFG., INC.	22
	A & N PRECISION INDUSTRIES	1
	AMERICAN QUALITY INDUSTRIES	15
AOL	ALL MANUFACTURERS INC.	12
AOL	ITT HARPER AEROSPACE FASTENER OPERATIONS	94
AP	ACCURATE AUTOMATIC PARTS CO	3
ap	ADVANCED PLASTICS, INC.	6
AP	AEROSPACE PRODUCTS CO.	8
	AIR PARTS MFG. CO.	10
	AIRDROME PARTS CO.	10
AP	ALL-POWER MFG. CO.	12
AP	ALL-PRO FASTENER & RIVET MFG. CO.	13
	ANATASE PRODUCTS	16
AP	APEX MFG. CO. INC.	17
AP	APHEONIX CORPORATION	17
A-P	AVIBANK MFG., INC.	22
	PILGRIM SCREW CORP.	144
APCO	AEROSPACE PRODUCTS	8
	APEL LTD.	16
APMI	A. P. MILLS INDUSTRIES FOR THE BLIND and WEST TENNESSEE LIONS BLIND IND. INC.	2, 193
APP	ALLIED PRECISION PRODUCTS, INC.	12
AR	A & R MFG CORP	1













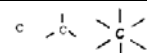

MIL-HDBK-57E (IS)

SYMBOL	COMPANY NAME	PAGE
	ACME RIVET & MACHINE CORP.	5
ARVAN, INC.	ARVAN, INC.	19
	AEROSTAR ENGINEERING & MANUFACTURING COMPANY	9
	ALL-STATES INC.	13
AS	AVIBANK MFG., INC.	22
	ARCO SALES CO.	17
	ASL MANUFACTURING INC.	19
ASP	ATLAS SPECIALTY PRODUCTS	20
ASP	CURTIS PRESTON ENTERPRISES INC.	51
	ARTISAN SPECIALIST TECH, INC.	19
ATBO ATLAS	ARMSTRONG ATLAS BOLT	18
	AVDEL INTERNATIONAL	21
AV	AVIBANK MFG., INC.	22
AVIBANK	AVIBANK MFG., INC.	22
AVK	AVIBANK MFG., INC.	22
	AVK INDUSTRIES PRODUCTS INC.	22
AVL	AVIBANK MFG., INC.	22
B		
	A & W SCREW MACHINE PRODUCTS, INC.	1
	AIW-ALTON INC.	11
	ARNOLD WRAGG (BOLTS & NUTS) LTD	19
A-W	AVIBANK MFG., INC.	22
AX	AEROMAX INDUSTRIES, INC.	8
	B & E MACHINE SHOP & SHEET METAL FAB., INC.	23
	B & E MANUFACTURING CO., INC.	23
B	BELL FASTENERS	27
	BELL-MEMPHIS, INC.	27
	BERGNER, RICHARD GMBH & CO	28
	BETA ENGINEERING, INC.	28
	BLANC AIRCRAFT FASTENERS, INC.	30
	BOBCAT MANUFACTURING CO.	30
	BOLT FASTENER STUD/TECHNOLOGY	31
B B+	BRISTOL INDUSTRIES	32
B1		





















SYMBOL	COMPANY NAME	PAGE
	BROADSTONE TOOL & DIE, INC.	33
	BUCK EYE FORGE, INC.	34
BALL-LOCK	AVIBANK MFG., INC.	22
	BARRE AEROSPACE PRODUCTS INC.	24
BAF	BLANC AIRCRAFT FASTENERS, INC.	30
BB	B & B SPECIALTIES, INC.	22
	BARNEGAT BAY NSCC, INC. DBA BB NSCC, INC.	24
BB BB	BIG BOLT CORP.	29
BB	LISI AEROSPACE	112
	BETA CORP.	28
BCC	BBC FASTENERS, INC.	25
BD BDM	SAFETY SOCKET SCREW CORP.	160
BDM	BRUNNER DRILLING & MFG. CO., INC.	33
	BOGNER ENGINEERING CO.	30
	BARCO ENGINEERING COMPANY, INC.	24
BEC	BEC MACHINE PRODUCTS COMPANY	26
BEI	ANOTHER SCREW MACHINE PRODUCT	16
	BOMAR ENGINEERING, INC.	31
BEK	BEK LEVEL 1 FASTENERS and LEVEL 1 FASTENERS	26, 108
	BENACO TOOLING RESEARCH & DEV. CORP.	27
BFG+	B F GOODRICH CO. RIVNUT ENGINEERED FASTENERS, THE	24
BFI	BRIARWOOD FASTENERS, INC.	31
	B G ENGINEERING, INC.	24
	B G M FASTENER CO., INC.	24
BH	BULTEN TRADING AB	35
BI	BEE INDUSTRIES, INC.	26
BI	BRISTOL INDUSTRIES	32
	BRINTCLIFFE TURNER LTD.	32
BIM	BUSAN INDUSTRIAL MACHINERY CO., LTD.	35
BL	BLAND CO., THE	30
BL	BRIGHT LIGHTS USA, INC.	32
BLC	AVIBANK MFG., INC.	22
BLSAVIBANK	AVIBANK MFG., INC.	22
	BEACH MACHINE	25















MIL-HDBK-57E (IS)

SYMBOL	COMPANY NAME	PAGE
BM	BERRY, JOHN DBA BERRY MANUFACTURING	28
BM	BERRY MANUFACTURING	28
BM	BRUNNER DRILLING & MFG. CO., INC.	33
BM	BRUNNER MANUFACTURING CO. DBA BRUNNER MANUFACTURING DIVISION	33
BM	BRYCO MACHINE, INC.	34
BM	BUSAN INDUSTRIAL MACHINERY CO., LTD.	35
BMC INC.	BRACELENTE MANUFACTURING CO., INC.	31
	BUCKEYE MACHINING, INC.	34
	BRADY MACHINE, INC.	31
	BRANCH MACHINE PARTS, INC.	31
	BOLT & NUT CO.	30
	B & N TOOL CO., INC.	23
	FRIEDR BOESNER GMBH	73
BOT	BEOTOOL CORP.	27
BP	BELL PRECISION, INC.	27
BP	BUFFALO PUMPS, INC.	34
B.P.C.	BEAVER PRODUCTS CORP.	26
	FERRY CAP & SET SCREW CO., THE	70
	BROWN PRODUCTION, INC.	33
	BER-LOW MFG INC.	28
	BUTECH PRESSURE SYSTEMS	35
BR	B & R MACHINE AND TOOL CORP	23
	BRIDEAN MACHINE & TOOL CO., INC.	32
	BURROWERS RESEARCH MACHINING, INC.	35
BT	BEGONIA TOOL COMPANY	26
	BLAINE TOOL CORP.	29
	BAS AEROSPACE LIMITED	25
BUFO	BULTEN TRADING AB	35
B U L A	BULA FORGE INC.	34
	BOLTWORKS, INC.	31
BVB	BRIDGEVIEW MANUFACTURING CO.	32
	ITW BUILDX	94
BY	BEN YUAN ENTERPRISE CO, LTD.	27
	EBERHARD BRUNINGHAUS	59
C		
C&D MACH	C & D MACHINE TOLL, INC.	36

SYMBOL	COMPANY NAME	PAGE
	CAMLOC PRODUCTS	41
C	CARDINAL INDUSTRIAL PRODUCTS	42
	CHAMPION FASTENERS, INC.	44
C	CHANCE, A.B. COMPANY	44
	CHIEF MFG.	45
	CINCH MANUFACTURING	46
C	CNC MACHINING INC.	47
	COAE BOLTS WORKS CO., LTD.	47
	COAST INDUSTRIAL SUPPLY CO., INC	47
C	CO-OP SCREW MANUFACTURING CORP.	48
	CSM FASTENER PRODUCTS	49
C 	HAZE SEIKO CO., LTD.	83
	REXNORD	155
C	SPS TECHNOLOGIES	169
C	TEXTRON FASTENING SYSTEMS	178
C	TOWNSEND CO.	181
CAMCAR	CAMCAR DIVISION OF TEXTRON INC.	38-40
CAMCAR	CAMCAR LLC	41
CAMLOC 	CAMLOC PRODUCTS, REXNORD	41,155
	CAM-TECH INDUSTRIES	41
	CONNECTICUT AIRCRAFT PRODUCTS	48
	BOBCAT MANUFACTURING CO.	30
CB	CLICK BOND, INC.	46
CBM	COMPUTA-BASE MACHINING, INC.	48
CBS CbS	CBS FASTENERS INC.	43
CCB	CCB INDUSTRIES, INC.	43
CCF	CCF ENTERPRISES INC.	43
CCS	SPS TECHNOLOGIES	169
	CAPRICE ENGINEERING CO., INC.	42
C. E. I	COMMAND ENTERPRISES	47
CES	C.E.S. MACHINE PRODUCTS, INC	36
	CHICAGO FASTENER MANUFACTURING	45
CFL	CLYDE FASTENERS LIMITED	46

MIL-HDBK-57E (IS)

SYMBOL	COMPANY NAME	PAGE
CFS	CARDINAL FASTENER & SPECIALTY CO., INC.	42
CCG	CORPUS CHRISTI GASKET & FASTENER LTD.	48
	CANADY MANUFACTURING CO. INC.	41
	CHU HUA INDUSTRIAL CO., LTD.	46
	COLD HEADING CO., THE	47
CHEREK	CHEREK MACHINE & TOOL CO., INC.	45
CHF	CHICAGO HARDWARE & FIXTURE CO.	45
CI	CATALINA INSTRUMENT CORPORATION	42
	SPS TECHNOLOGIES	169
	C. J.'S GENERAL MACHINE WORKS	36
	CENTERLINE TOOL & ENGINEERING, INC.	43
CM	CER-MAC INC.	44
	CM MANUFACTURING, INC.	46
	CRESENT MANUFACTURING CO.	49
	CERNY MFG. CO.	44
	CHRIS MACHINE CO.	45
CM I	CONQUEST MACHINE, INC.	48
	CENTURY METAL PARTS CORP.	44
	CRYSTAL METAL PRODUCTS COMPANY, INC.	49
	CAPY MACHINE SHOP, INC.	42
	OWARI PRECISE PRODUCTS CO., LTD	140
	CENTRAL OZARK MACHINE, INC.	43
	COPELAND MFG. CORP.	48
CP	CHANDLER PRODUCTS, INC.	44
CPI	CREATIVE PRECISION INC.	49
CPM	CHOICE PRECISION MACHINE, INC.	45
	C.R.D. MACHINING	36
	CRS PRECISION CORP.	49
	C & S ENGINEERING LLC	36
CS	CALIFORNIA SCREW PRODUCTS CORP.	37
C S		
	COPPER STATE BOLT & NUT CO.	48











SYMBOL	COMPANY NAME	PAGE
	CAMBRIDGE SPECIALTY COMPANY, INC.	38
C	CAMCAR DIVISION OF TEXTRON INC.	38-40
S D		
C-SI	CALABRESE & SONS, INC.	37
	CENTRAL SCREW PRODUCTS	44
	CHEROKEE TOOL & ENGINEERING CO., INC.	45
C W R C	CWR MANUFACTURING CO	50
D		
D & D	D & D TOOL COMPANY, INC.	50
	B & D THREADED ROLLING	23
	DACK INDUSTRIES, INC.	51
	DANIEL CO., EDWARD W.	51
D	DAN-LOC BOLT & GASKET INC.	51
D	DECKER MANUFACTURING CORP	52
	DEFIANCE STAMPING COMPANY, THE	53
D	DEHOUSSE (USINES)	53
	DELL MFG. CO., INC.	53
D	DEMAT	53
	DERBYSHIRE MACHINE & TOOL CO.	54
D	DIESEL PARTS COMPANY OF CALIFORNIA	54
D	DIHARD COMPANY	55
	DO MANUFACTURING CORP.	55
	DUPONT, G.B. CO., INC. and KAMAX L. P	57, 74, 98
	DUSEVOIR METAL PRODUCTS, INC.	57
D	DUVE GmbH & CO. KG	57
	DYSON CORP THE	58
	ONTIC ENGINEERING & MANUFACTURING, INC.	139
	STEEL WAREHOUSE COMPANY, INC.	171
D A E	DAVE ALLEN ENTERPRISES	51
DAS	DEFENSE AEROSPACE	52
1		
DB	DAN-LOC BOLT & GASKET INC.	51













MIL-HDBK-57E (IS)

SYMBOL	COMPANY NAME	PAGE
DC	D. C. MACHINING INC.	50
DDG	BLANC AERO INDUSTRIES and LISI	29, 112
	DYNAMIC ENGINEERING	57
DF™	DEUTSCH COMPANY INC., THE	54
d	DTF MANUFACTURING, INC.	56
DFCI <i>DFCI</i>	DFCI SOLUTIONS, INC.	54
	DETROIT HEADING CO.	54
DHL	DHL ENTERPRISES	54
	DIAL SUPPLY AND MANUFACTURING, INC.	54
D	DELT INDUSTRIES, INC.	53
DI	DUNCAN ELECTRONICS & MFG. CO	56
DF	DOMESTIC FORGING, INC.	55
DL	DISC-LOCK INTERNATIONAL	55
	MILLS, J. R. MACHINING, INC.	125
DMC	DECKER MANUFACTURING CORP	52
	DEPENDABLE MACHINE CO., INC.	54
	DELTA MACHINE & TOOL CO., INC.	53
DMT	DIXON MACHINE & TOOL and TROY D. RAY	55, 182
DORN <small>In connection with its friction mark of pic class 3.6 up to and 12.9</small>	KNIPPING-DORN GmbH	101
	TRW	183
D P	DARCO PRODUCTS	51
DP	DUNHAM PRODUCTS, INC.	57
DPM	DAVIES PRECISION MACHINING, INC.	51
	DEFENSE QUALITY MFG.	52
R	DOUBLECO INCORPORATED	56
	DEMAT	53
DTE	DOUGLASS TOOL & ENGINEERING CO., INC.	56
DTE	EMERALD VALLEY MFG	60











SYMBOL	COMPANY NAME	PAGE
	DTF MANUFACTURING, INC	56
	DUFFY ELECTRONICS & MFG. CO.	56
DUVE <i>DUVE</i>	DUVE GmbH & CO. KG	57
DUVEX	DUVE GmbH & CO. KG	57
DV	DEL-VAL FASTENER MANUFACTURING DUVE GmbH & CO. KG	53 57
DX DYNACAST	DYNACAST	57
DZUS <i>DZUS</i>	DZUS FASTENER CO., INC.	58
E		
	EAGAN MACHINE CORP.	58
E	EAST COAST METALS INC.	58
	EASTERN SCREW CO., INC.	59
E	EBC INDUSTRIES (ERIE)	59
E	ERIE BOLT CORP.	63
E	ELASTIC STOP NUT & ESNA	60, 116
E	ELCO INDUSTRIES, INC.	60
e	ELLIS PRECISION INDUSTRIES	60
	ENGINEERING MATERIALS CO., INC.	62-62
	ENOMOTO INDUSTRIES CO., LTD.	63
E	ERICO FASTENING SYSTEMS	63
	ESMET, INC.	63
E	NORTHBRIDGE FASTENERS	135
	R B & W CORPORATION	151
	VOSS INDUSTRIES, INC.	191
E A 	SUPERIOR TECHNOLOGY	174













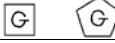

MIL-HDBK-57E (IS)

SYMBOL	COMPANY NAME	PAGE
EBM	EBERHARD BRUNINGHAUS	59
EBP	ENGINEERED BOLTING PRODUCTS, INC.	61
	ELCO INDUSTRIES, INC.	60
	E.L.R. MACHINE AND TOOL	58
EM	EASTWOOD MFG., CO.	59
 EM	ENGEL MANUFACTURING COMPANY, INC., THE	61
EM	ENGLE MANUFACTURING COMPANY, INC., THE	63
	ESSENTIAL MACHINING	64
	EXPERIMENTAL MACHINE CO.	65
EN	ELASTIC STOP NUT & ESNA	60, 116
	EAGLE PICHER INDUSTRIES	58
	EMPIRE PRECISION MACHINING and MD3 INDUSTRIES LTD.	61, 121
EPI	ESCO PRECISION, INC.	63
ERIE	EBC INDUSTRIES (ERIE)	59
ERIE	ERIE BOLT CORP.	63
ESC	ECENARRO S. COOP. LTDA	59
ESNA	ELASTIC STOP NUT & ESNA	60, 116
ESTA	ESTA PRODUCTS COMPANY	64
ET	AVIBANK MFG., INC.	22
ETC	AVIBANK MFG., INC.	22
EΣΠ	ESP MANUFACTURING CO., INC	64
EWB	SPS TECHNOLOGIES	169
EWN	SPS TECHNOLOGIES	169
 EXPANDO	PRECISE OF CALIFORNIA	147
F		
F593	ENGLE MANUFACTURING COMPANY, INC., THE	63
F	AVIATION MANUFACTURING GROUP LLC (SEE DBA FREEMAN CO., THE)	21
	BLUE TEE CORP DBA GEFCO/ STECO	30
	FAILING CO., GEORGE E	66
f	FALL RIVER MANUFACTURING CO., INC.	66
F F	(FASSCO) FASTENER & STEEL SUPPLY CO., LTD.	67
F	FASTENRATH BEFESTIGUNGSTECHNIK	68











SYMBOL	COMPANY NAME	PAGE
	GmbH	
F	FASTI-WERK CARL AUG. FASTENRATH GMBH & CO.KG	68
F	FASTRON COMPANY, THE	68
  F	FEDERAL SCREW WORKS	69
	FENBAR PRECISION MACHINISTS, INC.	69
	FERNDALE FASTENER	69
F	FREEMAN CO.	73
	LISI AEROSPACE	112
	M & M MANUFACTURING CORPORATION	114
F	VISSERIES & BOULONNERIES DE FOURMIES	188
F	FONTANA S.A.	72
2F 3F 4F 5F		
	THIANT (BOULONNERIE DE SA)	179
FAH	FRISBY AEROSPACE INC DE and TRIUMPH GROUP OPERATIONS INC, THE	73, 182
	FRONTIER BOLT COMPANY OF TEXAS	73
FC F-C	FERRY CAP & SET SCREW CO., THE	70
	FUCHS SCHRAUBENWERK GmbH	73
FCI	FONTAL CONTROLS, INC.	71
FDC	FLUIDYNE CORPORATION	71
	FABER ENTERPRISES, INC.	65
FE	FABSCO CORP.	66
	FLORES ENTERPRISES	71
FEC	FEDERAL EQUIPMENT COMPANY	68
60587		
 FF	FOREST FASTENERS	72
	FORMED FASTENER MANUFACTURING, INC.	72

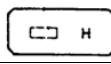





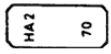
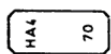



MIL-HDBK-57E (IS)

SYMBOL	COMPANY NAME	PAGE
F.K	VISSERIES & BOULONNERIES DE FOURMIES	188
	FLAIG & HOMMEL	70
	FENTON HEADING	69
	FIBAM COMPANHIA INDUSTRIAL	70
FIT	FASTENER INNOVATION TECHNOLOGY, INC.	67
	FLUIDONICS INC.	71
	FALCON MANUFACTURING CORP.	66
	FOLSOM TOOL & MOLD CORP.	71
F M C	FEDERAL MANUFACTURING CORP.	68
	TRIAD PRODUCTS CORP.	182
FN	AVIBANK MFG., INC.	22
FNF	SPS TECHNOLOGIES	169
	FASTENAL COMPANY	67
FONTANA	FONTANA S.A.	72
	FASTENING PRODUCTS OF LANCASTER, INC.	68
FPA	FPA MANUFACTURING	72
	FASTENING PRODUCTS CO., INC.	68
FPIC	FOREMOST PRECISION INSTRUMENT CORP.	72
fr	FALL RIVER MANUFACTURING CO., INC.	66
F.R.	FRANROE PRECISION MACHINE COMPANY	72
FRIEDBERG	AUGUST FRIEDBERG GmbH	20
F.R.P	FRANROE PRECISION MACHINE COMPANY	72
FS	FABRICATION SPECIALTY INC.	66
F S	FERRIERE DI STABIO, S.A.	69
FS	FLAIG & HOMMEL	70
f t	CAMCAR DIVISION OF TEXTRON INC.	38-40
FT	FASTENER TECHNOLOGY CORP.	67
	FUCHS SCHRAUBENWERK GmbH	73













SYMBOL	COMPANY NAME	PAGE
FX	FLEXALLOY INC.	71
G		
G	EVERLOCK FASTENING SYSTEMS	64,65
	GALAN PRECISION MACHINE CO.	74
	GALMAC MFG CO.	74
	GATEWAY SCREW AND RIVET, INC.	75
	GENERAL MACHINE PRODUCTS, INC	75
	GILL MACHINE & TOOL CO.	76
	GOSHO WORKS, LTD.	76
	GRACO INDUSTRIES, INC.	77
	GREER STOP NUT	78
	GUARDIAN RIVET & FASTENER	80
GAI	GATES ALBERT INC.	75
	GARDINER MFG. CO.	75
G.B.M	G. B. MACHINE PRECISION, INC.	74
	STERLING MARKING PRODUCTS IC.	173
	GRAUCH ENTERPRISES	77
GEBI 	J. GEORG BIERBACH	95
GF	GRANDUER FASTENERS, INC.	77
	GRIPCO, DIVISION OF BLACK & DECKER	78
GFM	GREENFIELD MANUFACTURING CO., INC.	78
G_H	EMHART CORP.	61
GII	GERTLER INDUSTRIES, INC.	75
	GL CNC SERVICE INC.	76
GLC 1		
GMF	GAITHER PATRICIA	74
	GMJ MACHINE COMPANY, INC.	76
GMT	GREATER MARYLAND TOOL & MFG., CORP.	77
	GRIPCO, DIVISION OF BLACK & DECKER	78
Go	GOSHO WORKS, LTD.	76
Gosho	GOSHO WORKS, LTD.	76
G-P	GROOV-PIN CORPORATION	79

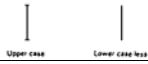





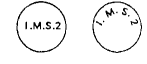
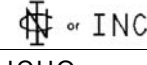

MIL-HDBK-57E (IS)

SYMBOL	COMPANY NAME	PAGE
GPM	GALAN PRECISION MACHINE CO.	74
G & R	G & R SCREW MACHINE PRODUCTS	74
GR	RABOURDIN	152
 GRMN 6	GERMAN MACHINED PRODUCTS, INC.	75
GS	B & B SPECIALTIES INC. and GS AEROSPACE TECHNOLOGY, INC.	22, 79
G-S	G & S MACHINE INC.	74
GS	GENERAL SCREW & SPECIALTY CO., INC.	75
GSAT	GS AEROSPACE TECHNOLOGY, INC.	79
GSF	ARMSTRONG FASTENINGS LTD.	18
GSF	GSF FASTENING	79
GSI	GS AEROSPACE TECHNOLOGY, INC.	79
	SCHRAUBENFABRIK GUSTAV STERNBERG GmbH & CO. KG	162
GTT	GUNNISON-INTERNATIONAL INC.	80
H		
H	BEK LEVEL 1 FASTENERS and LEVEL 1 FASTENERS	26, 108
	FUCHS SCHRAUBENWERK GmbH	73
	HAMANAKA (THAILAND). CO., LTD.	81
H	HASKELL OF HUNTINGTON, INC	82
h	HAYDON BOLTS, INC.	83
	HEMCO TOOL INC.	84
H	HEXAGON ENTERPRISES, INC.	84
	HILL FASTENER CORP.	85
H	HILTI, INC	86
H  	HI-SHEAR CORP. (LISI)	86
H	HOFFMANN, RICHARD GMBH CO. KG	87
H	HOLLYWOOD MANUFACTURING INC.	87
H	HUCK PRODUCTS	89
H	HUGGINS MFG.	89
H	HURON AUTOMATIC SCREW CO.	89
 H	MNP CORPORATION	128
	FUCHS SCHRAUBENWERK GmbH	73
	FUCHS SCHRAUBENWERK GmbH	73
HA	HABINA ENGINEERING	81
	HARTFORD AIRCRAFT PRODUCTS, INC.	82

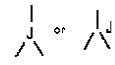

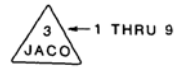







SYMBOL	COMPANY NAME	PAGE
	HARRISON BOLT & NUT CO., THE	82
HB	HYDROBOLT LIMITED	90
HBN	MNP CORPORATION	128
HBW	HAWTHORNE BOLT WORKS	
HC	H C MERCHANDISERS INC. and H C PACIFIC	80
HCP	H C MERCHANDISERS INC. and H C PACIFIC	80
 HD	HUGO DURHOLT GMBH & CO. KG	89
HDI	HARWOOD DESIGN, INC.	82
HE HE	HORST ENGINEERING & MANUFACTURING CO.	88
HEM	HORST ENGINEERING & MANUFACTURING CO.	88
	HILL FASTENER CORP.	85
HF	HYDRO FITTING MFG. CORP.	90
 HHW	HO HONG WORKS CO., LTD	87
	HI INDUSTRIAL TECHNOLOGIES	84
HIC	HALLSIMS INDUSTRIAL COMPONENTS, INC.	81
	HILL AEROSPACE & DEFENSE LLC.	85
HILTI	HILTI, INC	86
HI PSI	SPS TECHNOLOGIES	169
HI TI	SPS TECHNOLOGIES	169
HK HK H-K	HOLO-KROME CO.	87
HL	HLC INDUSTRIES INC.	86
HM	H. MULLINS, LTD.	80
hmc	HOWIE MANUFACTURING CO., INC.	88
	HEIM'S MACHINE & TOOL, INC.	83
HMTC	HOWE MACHINE AND TOOL CORP.	88
	CAMCAR DIVISION OF TETRON INC.	38-40
	H. PRINZ GmbH	80
HP 	HENWAY, INC.	84
	HIGHLAND PRODUCTS CORPORATION	85
HP	HOWELL PRECISION, INC.	88
HP	MICRO SCREW MACHINE PRODUCTS, INC.	124
HPF	HOUSTON PRECISION FASTENERS	88
HPS	HILTI, INC	86
HQ	HIGH QUALITY MACHINE SHOP	84
HR HR	HORSPPOOL & ROMINE MANUFACTURING CO., INC.	87

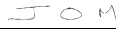











MIL-HDBK-57E (IS)

SYMBOL	COMPANY NAME	PAGE
	HARDWARE SPECIALTY CO, INC	82
HS	HILL STAMPING & MFG., INC.	85
hs HS hs	HI-SHEAR CORP.	86
hs	LISI AEROSPACE	111
HSC	HUNTER STEVENS COMPANY	89
HSLG-R	HILTI, INC	86
	HAMANAKA (THAILAND) CO., LTD.	81
H	HIGHLAND THREADS, INC.	85
H _T	HOWARD TOOL CO., INC.	88
HTC	HEITCO MANUFACTURING, INC.	84
HTE.	HIGH TECH ENTERPRISES	85
	HATCH INDUSTRIES	83
	HUNT VALVE COMPANY, INC.	89
HVI	HUNTINGTON VALLEY INDUSTRIES, INC. DBA HVI	90
I		
	EVERLOCK FASTENING SYSTEMS	65
I	ALPHA BOLT CO.	13
	IMPERIAL SUPPLIERS, INC.	91
I	INDUSTRIAL & AUTOMOTIVE FASTENERS	91
	INTERSTATE FITTINGS INC.	93
	PIONEER SCREW & NUT CO.	145
II	MACLEAN-FOGG CO.	116
III	COLOC MANUFACTURING	47
IAH	INDIANA AIRCRAFT HARDWARE	91
IF	IDEAL FASTENERS INC.	90
F	INDUSTRIAL FORGE, INC.	92
	I.G.D. MACHINE & TOOL LTD.	90
	STERLING MARKING PRODUCTS IC.	173
	CAMCAR DIVISION OF TEXTRON INC.	38-40
IM	INLAND MACHINE CO.	93
IM	IRVING MACHINE SERVICE, INC.	93
	INTERFLEX MFG. CORP.	93

SYMBOL	COMPANY NAME	PAGE
	INSTRUMENT MACHINING SERVICE LTD.	93
I.M.S.2		
	INDUSTRIAL NUT CORP.	92
ICHO	AIHARA SEIBYO CO LTD	10
	ISLAND ENGINEERING	94
IN	FASTENER BROKERAGE INC.	67
IN	INOFASST MANUFACTURING INC.	93
INBUS'	BAUER & SCHAURTE KARCHER GMBH	25
	IN-SPECK CORP.	93
IT	AVIBANK MFG., INC.	22
ITC	AVIBANK MFG., INC.	22
IRW	IRWIN AUTOMATION, INC.	94
J		
J	AF FASTENERS LIMITED	9
	B & G MANUFACTURING CO., INC.	23
J	HEWINS, EDMOND, C. JR DBA JET MACHINE WORKS COMPANY	84
J	JACOBSON MFG., LLC.	96
	JJ SCREW PRODUCTS, INC.	97
J	JOSLYN CORP.	97
	JUPITER WASHERS, INC.	97
J2H	B & G MANUFACTURING CO., INC.	23
J4	B & G MANUFACTURING CO., INC.	23
	JACO ENGINEERING, INC.	96
JB	BUTLER, INC.	35
B	JAY BEE MACHINE WORKS, INC.	96
JB7	B & G MANUFACTURING CO., INC.	23
JB16	B & G MANUFACTURING CO., INC.	23
	DEERE & CO.	52
	JAYCO ENGINEERING, INC.	96
	JERGENS INC.	97
JF	ELECTRO-FREETO MANUFACTURING COMPANY	60
	J. G. FASTENERS	95
H	HASSALL, JOHN, INC.	82
Jl	JAMISON INDUSTRIES INC.	96

MIL-HDBK-57E (IS)

SYMBOL	COMPANY NAME	PAGE
JIT	JUST IN TIME, INC.	98
	JAMES JACKSON DBA J J ENGINEERING	96, 97
	B & G MANUFACTURING CO., INC.	23
JP	J.M. PRECISION, INC.	95
JNC	B & G MANUFACTURING CO., INC.	23
JOLICO	JOLICO/J-B TOOL INC	97
	JAY O MACHINE CO., INC.	96
JS	B. V. FABRIEK VAN KLINKNAGELS EN SCHROEFBOUTEN V/H SMIT	24
J-S	J & S PRECISION PRODUCTS	95
	JAM TECH CORP.	96
K		
K	ADI MANUFACTURING, INC	6
	KAYNAR PRODUCTS (ALCOA FASTENING SYSTEMS)	99 11
	(Previously KAYNAR TECHNOLOGIES, INC. DIV. OF MICRODOT	124
K	KATSURAGAWA MACHINE SCREW CO., LTD.	99
K	KAYGOR, INC.	99
K	KEN FORGING, INC.	100
K	KILBOURN ENGINEERING CO.	100
	KEYSTONE BOLT & NUT COMPANY	100
	KEYSTONE TOOL & MACHINE CO.	100
	KNOCH MANUFACTURING CO. LTD.	101
	KOLB GMBH & CO.	101
		
K	KORODY COLYER CORP.	102
	KNOCH MANUFACTURING CO. LTD.	101
K	SPS TECHNOLOGIES	169
K-5673	SPS TECHNOLOGIES	169
KA	K.A.A. COMPANY	98
KAMAX	KAMAX-WERKE RUDOLF KELLERMANN GmbH & CO. KG	98
KARRO®	BAUER & SCHAURTE KARCHER GMBH	25
KDK	K.D.K. UPSET FORGING CO.	98
KE	KELLER ENGINEERING	99

SYMBOL	COMPANY NAME	PAGE
K+k	K & K PRECISION ENTERPRISES	98
	KYOKUTO MFG CO LTD.	103
KL	KLINCHER LOCKNUT CORP.	101
KLM	K.L.M. MACHINE INC.	101
 	KERR LAKESIDE INC.	100
KO	KO AMS MACHINE PRODUCTS	101
KP	KAPCO INDUSTRIES, INC.	99
	KIRSTEN PIPE CO. INC.	101
KPP	KOZAK, E. PERCISION PRODUCTS CO.	102
	KROBACH MANUFACTURING CORP.	103
	KONGO BYORA CO., LTD.	102
KNIPPING	ARNOLD KNIPPING GmbH	18
KPP	E. KOZAK PRECISION PRODUCTS CO.	58
KS	SPS TECHNOLOGIES	169
	KSS SOCKET SCREW, INC	103
	K-TECH MFG., INC.	103
KT		
	TURNAMICS, INC.	183
KTI	KONDOR TECHNOLOGIES, INC.	102
KTM	KREIS TOOL & MFG., CO., INC.	102
KX	KAMAX-WERKE RUDOLF KELLERMANN GmbH & CO. KG	98
	KYOEI SEISAKUSHO CO., LTD.	103
L		
L	CHUN YU WORKS & CO., LTD.	46
L	L & H THREADED RODS CORP.	104
 L	LAMSON AND SESSIONS OF CANADA LTD.	105
	LANIS MACHINE & MFG., CO.	106
	LINREAD NORTHBRIDGE AIRCRAFT PRODUCT DIVISION	109

MIL-HDBK-57E (IS)

SYMBOL	COMPANY NAME	PAGE
	LINREAD PUBLIC LIMITED CO.	110
L	LONE STAR FASTENERS, LP	113
L L1	LORD CORPORATION	114
	R B & W CORPORATION	151
LL	LINREAD PUBLIC LIMITED CO.	110
	LONG-LOK FASTENERS CORP.	113
LAH LH	LENTERN (AIRCRAFT) LTD.	107
LAM	L. A. MARTIN CO.	104
L B	LANARKSHIRE BOLT LTD.	106
	<i>Raised letters</i>	
	L & C MANUFACTURING CO., INC.	103
LC	LISI AEROSPACE	111
LE	LAKE ERIE SDREW CORP.	105
LE	LIPPISCHE EISENINDUSTRIE GmbH	111
LE	WOLTERS GMBH	196
LG	L G MACHINE & MFG INC.	104
LFC	LFC INDUSTRIES INC.	109
LH	L H INDUSTRIES, INC.	104
LI	LANA INDUSTRIES	106
	TRW	183
	L & J FASTENERS, INC.	104
L & M	L & M ENTERPRISES, INC.	104
LM	LEVINGSTON MACHINE COMPANY	109
LMC	LOUGHLIN MANUFACTURING CORP.	114
	LANUM METAL PRODUCTS, INC.	106
L.M.T.	LANUM METAL PRODUCTS, INC.	106
LMT	LLOYD MACHINE & TOOL CO., INC.	113
LNA	L N AEROSPACE, INC.	104, 113
LOBO	LOBO OFFICINE MECCANICHE SPA	113
LOBO	LOBO SYSTEMS LTD	113
LONG LOK	LONG-LOK FASTENERS CORP.	113
L. P. R.	L P R PRECISION PARTS AND TOOL COMPANY, INC.	104
LRA	AVIBANK MFG., INC.	22
LRG	L R G CORPORATION	104
L.P.R.	PRECISION PARTS & TOOL CO., INC.	147













SYMBOL	COMPANY NAME	PAGE
	R B & W CORPORATION	151
L-S-A	CEI INC.	43
L-S-A	LAND-SEA-AIR MACHINED PRODUCTS, INC.	106
L<W>M	LITTLE WORLD MANUFACTURING, INC.	113
M		
M	COOPER POWER SYSTEMS INC	48
M	DEMAT	53
	GFD LETAGE	76
M	HMS SERVICES LLC	87
	KELOX/MICRODOT PRODUCTS	99
	LISI AEROSPACE	112
M	MACKO INDUSTRIES	115
	MAGNUS TOOL & DIE CO., INC.	117
	MEACO PRODUCTS CORP.	122
M	MECAERO PRODUCTS	122
	MERCURY AREOSPACE INC.	123
M	METALCRAFTERS	123
	METRIX MFG. CO.	124
	MI. ME. AF. S.r.l	124
	MICRODOT INC	124
	MIDWEST ACORN NUT CO.	125
	MILLIPART, INC.	125
M	MINEBEA CO. LTD	126
M	M-MANUFACTURING	127
	MNP CORPORATION	128
	MORTON MANUFACTURING	129
M	MRL MANUFACTURING CORP.	130
	MACOR, INC.	117
	MIX TOOL CO.	126
	MODERN METRIC MACHINE COMPANY INC.	128











MIL-HDBK-57E (IS)

SYMBOL	COMPANY NAME	PAGE
	INFASCO, NFASCO NUT and INGERSOLL FASTENERS	93
	M.A.A. CORP.	114
	MAC FASTENERS, INC.	115
	MCCULLOUGH AERO CO.	121
	ADAMS, EARL M. CO.	6
	MAILLY MFG CO., INC.	117
	MID-STATES SCREW CORP.	125
MC	ADI MANUFACTURING, INC	6
	MCADAMS MACHINE AND TOOL CO.	120
	MECAERO CANADA INC.	122
	MECAIR AEROSPACE INDUSTRIES	122
	METALCRAFTERS	123
	MID CONTINENT SCREW PRODUCTS CO.	125
	WROUGHT WASHER MANUFACTURING INC.	197
	MARTIN-CHANDLER, INC.	118
MCO	MEACO PRODUCTS CORP.	121
	McMELLON BROS INC.	121
MD	LEONARD JED CO MARYLAND BOLT AND NUT CO DIV	107-108
MD	MARYLAND BOLT & NUT CO., INC.	119, 120
..MEL-BA..	MEL-BA MANUFACTURING INC.	122
	METRIX MFG. CO.	124
	METRIX MFG. CO.	124
MF	MACLEAN-FOGG CO.	116
	MORTON FASTENERS INC.	129
MFR06320	PYE & HOGAN MACHINE CO.	149
MFR 1L071	MIROFINE COMPANY	126
MFR 27624	PB FASTENERS	142
MFR 29839	ADVANCE PATTERN CORP	6
MFR 3L665	C. E. MACHINE CO., INC.	36
MFR - 72905	ARJAY PRECISION, INC.	17
MFR 8F781	STEVENS MFG. CO., INC.	173
	MANUFACTURING ENGINEERING TECH.	117

SYMBOL	COMPANY NAME	PAGE
	MOSTAR GEAR & MACHINE MFG., CO.	129
	MECHANICAL & INDUSTRIAL FASTENERS	122
	MECHANICAL INDUSTRIES LLC	122
	KELOX/MICRODOT PRODUCTS	99
	MICRODOT INC.	124
	MECHANICAL & INDUSTRIAL FASTENERS	122
	MODFORM-ILLINOIS, INC.	128
MI	MONOGRAM AEROSPACE FASTENERS	129
MI-TECH, INC	MI-TECH, INC.	126
	MIX TOOL CO.	126
	LISI AEROSPACE	112
	MKM MACHINE TOOL COMPANY INC.	127
ML	LINREAD PUBLIC LIMITED CO.	110
	MCLANE MFG INC.	121
	M.L.W. MANUFACTURING CO.	114
	MAR-BRO MFG., INC.	118
	MILE-HI MACHINE, INC.	125
	MACKSON MFG CORP.	115
MMG	MMG ENGINEERED COMPONENTS INC	127
M M M	HMS SERVICES LLC	87
	MODERN METRIC MACHINE COMPANY INC	128
	KERR, CHARLES W. and MAUI MEGA	100, 120
	MONROE MACHINED PRODUCTS, INC.	129
MMS	METHODS AND MACHINING SERVICES CO.	123
MMT	MAIN MACHINE CO INC.	117
MNP	MNP CORPORATION	128
	LISI AEROSPACE	112
MONOGRAM	MONOGRAM AEROSPACE FASTENERS	129
	MAPECO PRODUCTS, INC.	118
	MERCER PRODUCTS & MFG. CO., INC.	123

MIL-HDBK-57E (IS)

SYMBOL	COMPANY NAME	PAGE
MP	MONTEREY MACHINE PRODUCTS	129
	UMPCO CORP.	184
MR	MACHINERITE CORP.	115
	MASTER RESEARCH & MFG., INC.	120
MSA	M.S. AEROSPACE	114
MSF	MIL-SPEC FASTENERS CORP.	125
	MANUFACTURING SALES AND SERVICE	117
MT	ALEXANDER MANUFACTURING COMPANY INC	12
MT	AVIBANK MFG., INC.	22
M T	METAL-TECH MFG. INC.	123
	METRO TOOL & MANUFACTURING CO.	124
	MASTERCRAFT TOOL COMPANY	120
	MERCURY TOOL & MACHINE, INC.	123
	MANUFACTURING TECHNOLOGY SERVICES	118
	TWIST TITE MFG. INC.	183
MULTI-C	CARDINAL INDUSTRIAL PRODUCTS	42
	MOTOR WHEEL CORP.	130
MW ORD		
N		
N	HANSAN SCREW CO., LTD.	81
N	METALCRAFTERS	123
N	MITSUBOSHI INDUSTRIES, LTD.	126
N	MONOGRAM AEROSPACE FASTENERS	129
N	N.S.S. INDUSTRIES	130
N	NAFCO INDUSTRIES, INC.	130
	NAPIER'S AUTO BODY	130
N	NELSON STUD WELDING DIVISION	133
N	NEUMAYER, ERICH GMBH	133
N	NISSAN SCREW CO. LTD.	134
	NOCHIA STEELWORKS	134
	NOVA MACHINE PRODUCTS CORPORATION	136











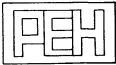

SYMBOL	COMPANY NAME	PAGE
n	NUCOR CORP.	136
N	NUTS INCORPORATED	136
N	NUTS, INC.	136
	ONO MANUFACTURER, INC.	139
NA	NELSON AEROSPACE INC.	132
NAC	NC AUTOMATED INDUSTRIES INC.	132
NB	LINREAD NORTHBRIDGE	109
	NATIONAL BOLTS & RIVETS LTD.	131
NB	NORTHBRIDGE FASTENERS	135
	ND INDUSTRIES	132
	NEVILLE MACHINE SHOP	133
NE	NEKG HOLDINGS	
NEDIN	NEDSCHROEF	132
NEDLOY	NEDSCHROEF	132
NEDUR	NEDSCHROEF	132
	NORTHEAST METAL CO., INC.	135
	NORTHEAST FASTENERS	135
NF	NEVADA BOLT AND MFG CO INC.	133
NF	NON-FERROUS BOLT & MANUFACTURNG CO.	134
NFB	GREER STOP NUT	78
NH	NEDSCHROEF	132
NH	NEW HORIZON MACHINE CO., INC.	133
NI	NAVPAR, INC.	131
NK	MITSUBOSHI INDUSTRIES, LTD.	126
NK NK	NYLOK CORP.	137
NKYM	MITSUBOSHI INDUSTRIES, LTD.	126
	METALCRAFTERS	123
NMB	MINEBEA CO. LTD	126
	NIPPON MACHINE ENGINEERING, INC.	134
NMP	NUMERIC MACHINE PRODUCTS	136
NRS	NAGOYA SCREW MANUFACTURING CO, LTD.	130
	NARRAGANSETT SCREW MFG.,CO.	131
	NISCO, INC.	134
NS	NORTHERN SCREW CO. , INC.	135
	NASU DENKI-TEKKO CO., LTD.	131

















MIL-HDBK-57E (IS)

SYMBOL	COMPANY NAME	PAGE
	NATIONAL THREADED FASTENERS CORP.	131
NT	NT ENGINEERING, INC.	136
NTF99	NORTHBRIDGE FASTENERS	135
NTW	NASSAN TOOL WORKS, INC.	131
	NUCOR CORP.	136
NYLOK	NYLOK CORP.	137
O		
	KERR, CHARLES W. and MAUI MEGA	100, 120
	MARUYKO NUT CO., LTD.	118
	NATIONAL FASTENER CO., LTD.	131
	OBARS MACHINE & TOOL CO.	137
	OCM MACHINE COMPANY, INC.	137
	OHIO NUT & BOLT CO., THE	137
	ORANGE PRECISION PARTS	139
	SCREWCORP.	163
	VOI-SHAN PRODUCTS	191
OAV	A. AGRATI S.P.A.	2
OB	OTT BROTHERS MACHINE CO., INC.	140
OBMC	OTT BROTHERS MACHINE CO., INC.	140
O K	OKAI IRON WORKS, INC	138
	OSTEEN MACHINE SHOP	140
	LOOS & CO., INC.	114
OP	ORANGE PRECISION PARTS	139
	ORDNANCE PARTS & ENGINEERING CO.	139
ORC-O	ORC-O TOOL & MACHINE, INC.	139
	OHKAWA SCREW MFG. CO., LTD. and OKAWA SCREW MANUFACTURING CO., LTD	138, 138
(OTC)	ORLOTRONICS CORP	139
OTF	OAKTREE FASTENERS CO.	137
P		
P	BELL FASTENERS	27
	BLANC AERO INDUSTRIES and LISI	29, 111
P	H. PAULIN & CO. LTD.	80
	H. PRINZ GmbH	80
	LELAND-POWELL FASTENERS, INC.	107













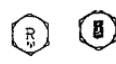

SYMBOL	COMPANY NAME	PAGE
P	LISI AEROSPACE	111
	LISI AEROSPACE	112
	OMEGA THREAD ROLLING AND GRINDING INC.	138
	PLAINVILLE MANUFACTURING CO., INC.	145
P	ORANGE PRECISION PARTS	139
	P.C.M., INC.	140
	PENN CIGAR MACHINES INC (P.C.M INC)	143
P	PATEREX, LTD.	142
P	PAULIN, H. & CO., LTD.	142
	PEINER UMFORMTECHNIK GmbH	143
	PERIGEE MANUFACTURING COMPANY, INC.	144
	PERKINS MACHINE CO.	144
	PIONEER SCREW & NUT CO.	145
	POLYTECHNIC INDUSTRIES	146
	PRECISION PIECE PARTS, INC.	147
	PROTO MACHINE CO., INC.	149
	PTM INTERNATIONAL INC	149
P	PURITAS METAL PRODUCTS	149
PABCOR	PABCOR, INC.	141
PAL	PALNUT CO., THE	142
PAL	TRW	183
PAM	ABBOTT, PETER	3
PAM	PRECISION AIRCRAFT MACHINING CO., INC. DBA PAMCO	
PAMCO	PRECISION AIRCRAFT MACHINING CO., INC. DBA PAMCO	
	PRECISE AERO PRODUCTS	146
PB	PB FASTENERS	
PB	PORTLAND BOLT & MFG., CO.	146
	UPB ENGINEERING	186
PBB	LISI AEROSPACE	112



















MIL-HDBK-57E (IS)

SYMBOL	COMPANY NAME	PAGE
	PB FASTENERS	
 PBF		
PC	APHEONIX CORPORATION	17
	PRODUCT DEVELOPMENT GROUP, INC.	148
PE	PENNINGENGINEERING AUTOMOTIVE FASTENERS	
	PROMPTUS ELECTRONIC HARDWARE	149
PEINER	PEINER UMFORMTECHNIK GmbH	143
	PENN ENGINEERING & MANUFACTURING CO.	143
PHP	PNEU-HYDRO PRODUCTS, INC.	145
	P & I ASSOCIATES, INC.	140
PIP	AVIBANK MFG., INC.	22
PK	KAPCO INDUSTRIES, INC.	99
	P & L ENTERPRISES	140
PM	H. PAULIN & CO. LTD.	80
PM	PAULIN, H. & CO., LTD.	142
	PRICE MANUFACTURING CO.	148
PMC	BELL FASTENERS	27
	POINT MACHINE COMPANY	145
	PRECISIONMATICS CO., INC.	148
	PRIETO MACHINE COMPANY, INC.	148
PMC	VERTEX DISTRIBUTION	188
PMI	PADGETT MACHINE INC.	141
PMi	PEREZ MACHINE, INC.	144
PMP	PIONEER MACHINE PRODUCTS, INC.	145
PMP	PURITAS METAL PRODUCTS	149
	PRO-MACHINE & TOOL COMPANY	149
	PATTERSON LAKE PRODUCTS	142
-PPC-	PARK PRECISION CORPORATION	142
	POWERPARTS, INC.	146
PR	PINEY RIDGE CO.	145
PRD	PRD FASTENERS LTD.	146































SYMBOL	COMPANY NAME	PAGE
	PRECI-MANUFACTURING, INC.	146
	H. PRINZ GmbH	80
	P.S. MACHINE CO., INC.	141
PS	PACIFIC SCIENTIFIC	141
	PEERLESS SCREW PRODUCTS	142
	PHOENIX SPECIALTY MANUFACTURING CO., INC.	144
	PRECISION SCREW & BOLT, INC.	147
PSM <i>PSM</i>	PENN SCREW & MACHINE WORKS, INC.	144
	PRODUCTION & TOOL COMPANY	148
	PACIFIC TOOL, INC.	141
PTI	PAINTER TOOL, INC.	141
	PRECISION TECHNOLOGIES, INC.	147
PTM	PINE TAVERN MACHINE INC.	145
PTX	PATEREX, LTD.	142
	TRW	183
Q		
	QSN MANUFACTURING, INC.	150
Q	QUALITY SCREW PRODUCTS, INC.	150
	ALL QUALITY SPARES, INC.	12
QAS	QUALITY AIRCRAFT SCREWS, INC.	150
	CELTECH ENTERPRISE	43
	QUALITY FABRICATIONS, INC.	150
	QUALITY MACHINE & MFG INC.	150
	QUALITY SOCKET SCREW MANUFACTURING CORP.	150
QSS		
QT	QUALITY THREADED PRODUCTS COMPANY	150































MIL-HDBK-57E (IS)

SYMBOL	COMPANY NAME	PAGE
R		
	R.E.C. CORP.	152
		
	RAHMEDE SCHRAUBENFABRIK	153
R	RAM THREADING, INC.	153
R	RAMAR NUTS, INC.	153
R	REPUBLIC FASTENER MANUFACTURING CORP.	155
	RINCO TECHNOLOGIES, INC.	156
	ROBBINS MANUFACTURING	157
	ROCKFORD BOLT & STEEL CO.	157
R	ROCKFORD FASTENERS INC.	157
	ROCKFORD PRODUCTS CORP.	158
	ROGG MANUFACTURING COMPANY	158
R	RONSON MANUFACTURING, INC.	158
	RUMCO, INC.	159
R	UNIFLOW CORP.	184
R9	REID PRODUCT INC.	
RAE	RAE MANUFACTURING CO.	153
RAM	RAM PRODUCTS	153
	R. BILD COMPANY, INC	152
	ROCKFORD BOLT & STEEL CO.	157
R B W	R B & W CORPORATION	151,152
		
	R & D FASTENERS	151
	R & D WELDING & MACHINE INC.	151
	RAMM DEFENSE PRODUCTS	154
RE	RAM ENTERPRISES	153
	REED INSTRUMENT CO.	155















SYMBOL	COMPANY NAME	PAGE
REP	RIVNUT ENGINEERED PRODUCTS, INC.	157
	REXNORD	155
	ROBERT HENRY CO., INC.	157
	REXNORD	155
	ROSAN PRODUCTS	158
	RUDOLPH INSTRUMENTS, INC.	159
	BERGNER, RICHARD GMBH & CO.	28
R.I.E.	R & I ENTERPRISES DBA COMPULOGIC DESIGN CO.	151
	R B & W CORPORATION	151,152
R/M	MANNO, RICHARD & CO., INC.	117
	RICHARD MFG. CO., INC.	155
	RAINBOW MACHINE PRODUCTS, INC.	153
RMS	RMS	157
Rp	REID PRODUCT INC.	155
	R & R PRECISION	151
RR	GRUPO RASSINI S.A. de C.V.	79
RS 	RS MANUFACTURING, INC.	159
RT	AVIBANK MFG., INC.	22
	RUSCOMB TOOL & MACHNE CO., INC.	159
RVT	RIVER VALLEY TOOL & MANUFACTURING	156
	RA-WHITE, INC.	154
	RADAX INDUSTRIES, INC.	152
S		
S	BELL FASTENERS	27
S	J.P. PRODUCTS, INC.	96
	MNP CORPORATION	128
	NIPPON STEEL BOLTEN CO., LTD.	134
	S.I. STUD, INC.	160
S	SABRE MANUFACTURING, INC.	160
	SAI INDUSTRIES CORP. EFT 2	161
S	SCHUHL & CO. GMBH	162
•S•	SALES SYSTEM, LIMITED	161









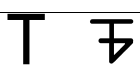









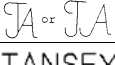

MIL-HDBK-57E (IS)

SYMBOL	COMPANY NAME	PAGE
	SEMBLEX CORP.	163
	SEMCO FASTENER	163
	SENG HENG ENGINEERING PTE LTD.	163
	SONIC INDUSTRIES, INC.	166
	SESCO INDUSTRIES, INC.	163
	SHACKELFORD MACHING, INC.	163
	SHEFFIELD, INC.	164
	SHIGA BOLT CO., LTD.	164
	SIERRACIN/HARRISON	165
	SKYLINE INDUSTRIES	165
	SPECIALS, INC.	168
	SPECIALTY SCREW CORP.	168
	SPS TECHNOLOGIES	169
	SRI SAI INDUSTRIES CORPORATION	170
	STANDARD NUT & BOLT, INC.	171
	STELFAST FASTENERS, INC.	172
	STERLING MFG. & SUPPLY , INC.	173
	SULLIVAN BOLT CO., INC.	174
	U.S. BOLT MANUFACTURING, INC.	184
	WILHELM SCHUMACHER SCHRAUBEN-FABRIK GmbH	195
	BULTEN TRADING AB	35
	SPACE AGE ENGINEERING, INC.	167
	SANTA ANA GEAR & MACHINE	161
	D'SAMIC	56
	SOUTHWEST ALLIED PRODUCTS CO., INC.	167
	SOUTH BAY BOLT MANUFACTURING CO.	166
	S. B. E. (ITALY CORPORATION)	160
	SPS TECHNOLOGIES	169
	VOI-SHAN PRODUCTS	191
		

SYMBOL	COMPANY NAME	PAGE
	STERLING MACHINE COMPANY	173
		
	SCANDIA MFG. CO., INC.	162
	STEEL CITY BOLT & SCREW, INC.	171
	SCOTT CRAFT CO.	162
	SPURWAY COOKE INDUSTRIES PTE LTD.	170
	CAMCAR DIVISION OF TEXTRON INC.	38-40
	SIMMONDS PRODUCTS	165
	STALKER & DYSTHE, INC.	170
	TANAKA LTD.	176
	CAMCAR DIVISION OF TEXTRON INC.	38-40
	SOUTHERN FASTENER CORPORATION	167
	SONFARREL, INC.	166
	SHAMROCK FASTENER TECHNOLOGIES, LLC	163
	SAGA TEKKOSHO CO., LTD.	161
	SHUR-LOK CORP.	164
	SIERRA PACIFIC SUPPLY CO., INC.	165
	SOUTHWEST INDUSTRIAL SERVICES	167
	SUBURBAN INDUSTRIES, INC.	174
	SHUR-KUT SUPPLY CORPORATION	164
	S & L METAL PRODUCTS CORP.	159
	SHUR-LOK COMPANY.	164
	ST. LOUIS SCREW & BOLT CO.	170
	GREER STOP NUT	78
	SPACE-LOK, INC.	168
	STANDARD LOCKNUT, INC.	171
	SAMUEL MARSDEN & SON	161
	SKY MANUFACTURING	165
	STURM MACHINE CO., INC.	174
	SATAIR MANUFACTURING FACILITY	162
	SANDIK MANUFACTURING, INC.	161

MIL-HDBK-57E (IS)

SYMBOL	COMPANY NAME	PAGE
SMP	SHORELINE MACHINE PRODUCTS, INC.	164
SM&M	SMITH MACHINE & MANUFACTURING	166
	SLABE MACHINE PRODUCTS	166
	FILETAG INTERNATIONAL	70
	SKYSPARES PARTS, INC.	165
SPG	SHAW PRECISION GRINDING	4, 164
	SPARTAN PRECISION MACHINE	168
	STEEL PRODUCTS OF MASSILLION	171
SPS SPS	SPS TECHNOLOGIES	169
SpSc	SPACE SCREW, INC.	167
	MNP CORPORATION	128
	SOUTHERN FASTENING SYSTEMS	167
ST	AVIBANK MFG., INC.	22
	SWISS TECHNOLOGY, INC.	175
	SPIRAL TOOL CORP.	168
	STEADFAST CORPORATION	171
	SINN-TECH, INC.	165
	HALL INDUSTRIES INC. and STANDARD TOOL & MACHINE CO.	81, 171
STM	SPECIAL-T-METALS	168
STRUX (radial)	CAMCAR DIVISION OF TEXTRON INC.	38-40
SV	S V INDUSTRIES	175
SW	BELL FASTENERS	27
	SMITH WELDING, INC.	166
SW	STILLWATER FASTENERS, INC.	173
	SOUTHWIND INDUSTRIES, INC.	167
T		
	ARCHER SCREW PRODUCTS	17
T	BLANC AERO INDUSTRIES	29
T	ENGLE MANUFACTURING COMPANY, INC., THE	63
	LISI AEROSPACE	111











SYMBOL	COMPANY NAME	PAGE
T	MINEBEA CO. LTD	126
	OSAKA SEIKI CO., LTD.	139
	RING SCREW WORKS	156
T	SPS TECHNOLOGIES	169
	T & E MACHINE CORP.	175
	TORCO, INC.	181
	TAKENAKA SEISAKUSHO CO., LTD.	176
	TECHNICAL FASTENERS, INC.	176
T	TELEFAST INDUSTRIES, INC.	177
T	TERRY MACHINE CO.	177
	TEXAS BOLT CO.	177
	TEXTRON FASTENING SYSTEMS	178
	TITAN FASTENER	180
	TOPURA CO., LTD.	180
	TOWNSEND CO.	181
	TOYO STEEL WIRE CO., LTD.	181
	TRY - AZTEC COMPANY	183
TANSEY	ARVAN, INC.	19
	TEBCO THREADED FASTENERS	176
	TEXAS BOLT CO.	177
	T-B & S MFG.	176
	SPS TECHNOLOGIES	169, 170
	TERRYCABLE, INC.	177
TCQ	T C QUALITY MACHINING INC.	175
	T & E MACHINE CORP.	175
	TEK PRECISION CO., LTD.	176
TELLEP	SPS TECHNOLOGIES-METALAC SPS INDUSTRIA	169
TENS	TENS MACHINE CO., INC.	177















MIL-HDBK-57E (IS)

SYMBOL	COMPANY NAME	PAGE
	TEXAS BOLT CO.	177
TEXAS BOLT		
TF	TELEFAST INDUSTRIES, INC.	177
F	HI-SHEAR CORP. and TORONTO FASTENERS INDUSTRIES, INC.	86, 181
·IF	TFI AEROSPACE CORPORATION	178
	TFP CORP.	178
F	TUFF FASTENERS CO.	183
·IF	TFI AEROSPACE CORPORATION	178
	TFP CORP.	178
THE	TONG HWEI ENTERPRISE CO., LTD.	180
	THIANT (BOULONNERIE DE SA)	179
THOMAS	THOMAS MFG, INC.	180
	THOMAS INSTRUMENT & MACHINE CO., INC.	179
	LEBRECHT TIGGES GmbH & CO. KG and SCHMICO GMBH SCHWEISSTECHNIK	106, 162
TJB	SPS TECHNOLOGIES	169
TKS	TOKOSHA METAL WORKS LTD.	180
	TOOLEX, INC.	180
TLP	SPS TECHNOLOGIES	169
	SPS TECHNOLOGIES	169
	TERRY MACHINE CO.	177
	TRIDENT MACHINE CO.	182
TM	TRONSON MANUFACTURING	182
TM9	SPS TECHNOLOGIES	169
TMC	LISI AEROSPACE	112
	FARLO MACHINE & TOOL CO., INC.	66
TMS	MACHINE SHOP, INC., THE	115
TMTI	THOMAS MACHINING TECHNOLOGIES, INC.	179
TN	NICE TOOL MFG., INC.	133

















SYMBOL	COMPANY NAME	PAGE
	TOG MANUFACTURING CO., INC.	180
	OTO MELARA S.p.A.	140
TORX (radial)	CAMCAR DIVISION OF TEXTRON INC.	38-40
TOPURA	TOPURA CO., LTD.	180
TP	TOPURA CO., LTD.	180
	TEXAS PRECISION MFG., INC.	177
TR	T R MACHINE INC.	175
	TOWNE ROBINSON FASTENER CO.	181
TRI	TRIUMPH MANUFACTURING CO., INC.	182
Tridair	REXNORD	155
TRIDAIR	TRIDAIR PRODUCTS	182
	TRW	183
TTC	CAMCAR DIVISION OF TEXTRON INC.	38-40
TUZ	MAUDLE INDUSTRIAL CO., LTD.	120
	SUNDRAM FASTENERS, LTD.	174
TVS		
	TFP CORP.	178
	LENCH, THOMAS WILLIAM, LTD.	107
<small>Raised letters</small>	<small>Indented letters</small>	
TYE	YOUNG ENGINEERS INC, THE	198
U		
	OHKAWA SCREW MFG. CO., LTD. and OKAWA SCREW MANUFACTURING CO., LTD	138
	OKABE CO., INC.	138
	R B & W CORPORATION	151
U	SPS TECHNOLOGIES	169
U	UNBRACO PTY LTD	169
U	UNIMETERIC CORPORATION	185
	UNITED DRILL BUSHING CORP.	185
	URANIA ENGINEERING CO., INC.	186
	URBAN MANUFACTURING CO.	186
	URBAN MFG. CO. INC.	186



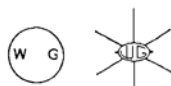











MIL-HDBK-57E (IS)

SYMBOL	COMPANY NAME	PAGE
U130	SPS TECHNOLOGIES	169
UH	CHU HUA INDUSTRIAL CO., LTD.	46
UM	SPS TECHNOLOGIES	169
	UNBRACO PTY LTD.	169
UM	UNIVERSAL MACHINE PRODUCTS	186
	ULTIMATE MACHINING & WELDING	184
UNBRAKO	SPS TECHNOLOGIES	169
	SPS TECHNOLOGIES	169
UNISTRUT	UNISTRUT CORP.	185
		
UNW	SPS TECHNOLOGIES	169
UP	UNITED PRECISION PRODUCTS CO., INC.	185
UPME	U.P. MACHINE & ENGINEERING CO.	184
	UNITED STATES DEFENSE RESEARCH & SUPPLY	185
	UNITED STEEL & FASTENERS INC.	186
	DOMESTIC FASTENER & FORGE, INC	55
01AK		
USMC	ULTRA SONIC MACHINE CO., INC	184
	US TOOL & DIE	187
V		
V	AERCO RESEARCH	7
	AERO COMPONENTS CO	7
V	CHAMPION COMMERCIAL INDUSTRIES, INC.	44
V	MNP CORPORATION	128
V	PACER ALLOYS, INC.	141
	V-B MACHINE CO., INC.	187
V	VICO PRODUCTS, CO.	188
V	VICTOR PRODUCTS CORP.	188
	VISTEK INDUSTRIES	189
	VITCO NUCLEAR PRODUCTS INC.	189





SYMBOL	COMPANY NAME	PAGE
.V.	VMC INDUSTRIES, INC.	189
V	VOSS INDUSTRIES, INC.	191
V. V. 304 V.	VULCAN RIVET & BOLT CORP.	191
VALCOR	VALCOR ENGINEERING CORP.	187
VERBUS	BAUER & SCHAURTE KARCHER GMBH	25
VF	MNP CORPORATION	128
	VALLEY FORGE AND BOLT MFG CO.	187
	VENUS FASTENERS CORP.	188
V F M	VEGAS FASTENER MANUFACTURING	187
	VIP MFG. & ENGR. CORP.	188
	VM MANUFACTURING CORP.	189
VMC	VMC INDUSTRIES, INC.	189
	VOSS INDUSTRIES, INC.	191
vp	VAN PETTY MFG., INC.	187
VS VS VS	VOI-SHAN PRODUCTS	191
VS	VSI	191
V	VERSATECH, INC.	188
	VALLEY-TODECO	187
W		
W	MEC WOLF SRL	121
	WALZ & KRENZER INC DBA MAPECO PRODUCTS	192
	WARREN PUMPS LLC	192
	WATERBURY BUCKLE CO.	192
	WAYNE BOLT & NUT CO., INC.	192
	WELTON ROLLED THREAD CORP.	192
	WESTLAND STEEL PRODUCTS, LTD.	194
	WHELAN MACHINE & TOOL CO.	194
	WHITNEY SCREW CORP.	194
	WIGLEY MACHINE COMPANY	194





























MIL-HDBK-57E (IS)

SYMBOL	COMPANY NAME	PAGE
	WILLIAM'S MACHINE & FABRICATION, INC.	195
W	WINKER HERMAN GMBH & CO. KG	195
	WODIN, INC.	196
	WOLTERS GMBH	196
	WROUGHT WASHER MANUFACTURING INC.	197
	WYANDOTTE INDUSTRIES, INC.	197
	WYNNSON ENTERPRISES, INC.	197
	WINSLOW AUTOMATICS, INC.	196
WB	WALKER BOLT MANUFACTURING CO., INC.	191
	WEBLUK MACHINE CORP.	192
	WEST COAST AEROSPACE, INC.	193
WEDGELOCK	MONOGRAM AEROSPACE FASTENERS	129
WESLOK	WESLOK	193
	WESTFIELD FASTENERS	194
	WILSON-GARNER CO.	195
	RATHMANN WALTER G. SEGMENT-KLAMMERSCHRAUBEN GMBH	154
	WHITTET-HIGGINS CO.	194
WH	WOLTERS GMBH	196
	WOLSTENHOLME MACHINE	196
WMI	WEAVER MANUFACTURING, INC.	192
	WIL-NIC	195
	WESTERN PACIFIC ENTERPRISES, W.P.E. INC.	193
WPE		
	WESTWOOD PRECISION, INC.	194
Wpp	WILT PRECISION PRODUCTS	195















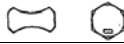





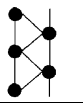



SYMBOL	COMPANY NAME	PAGE
	CUTTING EDGE MACHINING INC. and WESTERN SCREW MACHINE PRODUCTS, INC.	50, 193
WSI	WESTERN SKY INDUSTRIES, INC.	193
WSMP	WORTHEY MACHINE	197
	KAMPWERK VIEREGGE U. PICKARDT GMBH. & CO.	98
	WILHELM SCHUMACHER SCHRAUBEN-FABRIK GmbH	195
WSN		
	TW DESIGN AND MANUFACTURING, L.L.C.	183
WWE	LINREAD PUBLIC LIMITED CO.	110
X		
	EXCEL PRECISION PRODUCTS, INC.	65
XP	R B & W CORPORATION	151
Y		
	YOW MENGI INDUSTRIAL CO., LTD.	198
Y 2 K	Y2K MACHINE SHOP	197
	FANG SHENG SCREW CO., LTD.	66
	YATES TOOL, INC.	198
Z		
Z	D.S.O. PLASTICS, INC.	50
	FITZ MANUFACTURING INDUSTRIES LTD DBA FMI	70
	ZAMON CO., INC.	198
Z	ZERO PRODUCTS, INC.	198
	Z & B GENERAL MACHINE	198
ZENEX	ZENEX CORPORATION	198
	ZERO PRODUCTS, INC.	198
NUMBER		
	AERO-FAB, INC.	7
0XK38	NORTHSTAR ENGINEERING	135
01DC	RISCO, INCORPORATED	156
	MAC FASTENERS, INC.	115
01FO	ACCUTOOL	4
01FO	SUBCON TOOL/ACCUTOOL MACHINE GROUP INC. (DBA ACCUTOOL)	174
0F0Y2	ADVANCED MACHINING	6







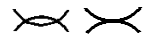
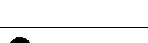













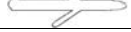



MIL-HDBK-57E (IS)

SYMBOL	COMPANY NAME	PAGE
	TECHNOLOGIES	
01NU	EAGLEHEAD MANUFACTURING COMPANY	58
05DT8	FITZ MANUFACTURING INDUSTRIES LTD DBA FMI	70
05141	McMELLON BROS INC.	121
09094	QRP, INC.	149
1A249	ACCURATE THREADED PRODUCTS CO.	4
1EM77	GS AEROSPACE TECHNOLOGY, INC.	79
1H423	J & M MACHINE INC.	95
1st	FIRST AMERICAN SALES CO.	70
1Y128	D & D MACHINERY AND SALES	50
1YFG0	MAGNUM MACHINE SHOP	117
15077	NORTHBRIDGE FASTENERS	135
2	STERLING MACHINE COMPANY	173
2F 3F 4F 5F	FONTANA S.A.	72
2A832	JMT MACHINE COMPANY	97
20733	NORTHBRIDGE FASTENERS	135
	UTAH TOOL & DIE, INC.	187
28548	FABRICATION SPECIALTY INC.	66
	3D MACHINE COMPANY, INC	1
3D531	ALAN, JEFFREY, MFG. & ENGR	11
	MODERN METRIC MACHINE COMPANY INC.	128
30633	C & H MFG., INC.	36
32219	NORTHBRIDGE FASTENERS	135
4J952	GENERAL AVIATION MFG., INC.	75
4J976	REGAL AIR, INC	155
4N133	CHATHAM PRECISION, INC.	45
4T853	D & R MACHINE COMPANY	50
5T572	NORTHBRIDGE FASTENERS	135
509W0	BOMBSHELL, INC.	31
54878	ROTAIR INDUSTRIES, INC.	159
56878	SPS TECHNOLOGIES	169
	BISHOP ENTERPRISES, INC.	29
60529	STERLING MFG. & SUPPLY, INC.	173
61062	COMET MFG. CO., INC.	47
62206	B & B SPECIALTIES, INC.	22
7	HEPTNER MFG CO.	84
71838	SPS TECHNOLOGIES	169
8F781	STEVENS MFG. CO., INC.	173
8M938	PRODUCTS DESIGN & MFG. CORP.	149
8T968	ROMAC ELECTRONICS, INC.	158
80539	SPS TECHNOLOGIES	169
84256	AVIBANK MFG., INC.	22

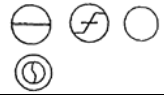
SYMBOL	COMPANY NAME	PAGE
	THIANT (BOULONNERIE DE SA)	179
99106	AMERICAN AIRCRAFT PARTS MANUFACTURING COMPANY	14
9R	REID PRODUCT INC.	
SYMBOL		
	3 V FASTENERS	1
	A & G ENGINEERING CO., INC	1
 	ACME RIVET & MACHINE CORP.	5
	AVDEL INTERNATIONAL	21
	ACRODYNE MFG CO.	5
 	AEROSPACE RIVET MFG CORP	9
	ALCOA FASTENING SYSTEMS	11
	KAYNAR PRODUCTS	99
	(Previously KAYNAR TECHNOLOGIES, INC DIV. OF MICRODOT	124
	ALCOA GLOBAL FASTENERS INC	12
	ALL PINS MANUFACTURING	12
=	ALL-STATES INC.	13
 	ANCHOR BOLT & SCREW CO.	16
	ANILLO INDUSTRIES, INC.	16
	ARMSTRONG FASTENING SYSTEMS	18
	ASI DESIGN & MANUFACTURING, INC.	19
	AUTO SCREW, INC.	21
	AMERITECH FASTNER MFG INC.	15
	ARGARWAL INDUSTRIES	17
	AVIBANK MFG., INC.	22
	AZTECH ENGINEERING, INC.	22
	BAUER & SCHAURTE KARCHER GMBH	25
	BOLLHOFF & CO. GmbH & CO. KG	30
	CARR CO.	42
	CLEVELAND HARDWARE & FORGING and GREEN BAY DROP FORGE	46, 77
	CODLING TOOL & MFG. INC.	47
	CODLING TOOL & MFG. INC.	47
	COLD HEADING CO., THE	47
	DAVIS AIRCRAFT PRODUCT CO., INC.	51

MIL-HDBK-57E (IS)

SYMBOL	COMPANY NAME	PAGE
	DO-ALL PRECISION, INC.	55
	DRESSER INDUSTRIES, INC.	56
	EDS ORDNANCE	59
	ELCO INDUSTRIES, INC.	60
	GEN FAST MANUFACTURING COMPANY	75
	STELCO FASTENER & FORGING CO.	172
	EMHART CORP.	61
	FRIEDR BOESNER GMBH	73
	INFASCO, NFASCO NUT and INGERSOLL FASTENERS	93
	FENTON HEADING	69
	FERNDALE FASTENER	69
	FISCHER SPECIAL MFG. CO.	70
	PRECISION METAL PRODUCTS CO.	147
	FOREST FASTENERS	72
	GMP CO. CORPORATION	76
	PILGRIM SCREW CORP.	144
	GRADON SCREW MACHINE CORP.	77
	GROOV-PIN CORPORATION	79
	HANDI GADETS CORP.	81
	HEARTLAND PRECISION FASTENER	83
	HESSISCHE SCHRAUBENFABRIK WELTER GmbH & CO., KG	84
	WELTER GMBH & CO. KG	192
	HOUSTON FASTENER	85
	HUCK AEROSPACE PRODUCTS	89
	HUCK INTERNATIONAL PRODUCTS	89
	HURRICANE MACHINE COMPANY, L.L.C.	90

SYMBOL	COMPANY NAME	PAGE
	INDUX, S.A. DE C.E.	92
	ITW CIP	94
	KOBE FASTENER LIMITED	101
	KOREA BOLT IND., CO., LTD.	102
	KPF	102
	LBL PRODUCTS	106
	LINREAD NORTHBRIDGE AIRCRAFT PRODUCT DIVISION	109
	LISI AEROSPACE	111
	MACK, A. W. MFG CO.	115
	MINEBEA CO. LTD	126
	NAGOYA SCREW MANUFACTURING CO., LTD.	130
	NCMI BRUEGGEMANN INC.	132
	ONEIDA TOOL & MACHINE CORP.	138
	PELHAM AUTO MATRIX PRECISION	143
	PINTO PRODUCTS	145
	PREM INDUSTRIES, INC.	148
	RELIANT FASTENER	155
	REXNORD	155
	TRIDAIR PRODUCTS	182
	RING SCREW WORKS	156
	ROBBINS MANUFACTURING	157
	ROTAIR INDUSTRIES, INC.	159
	SANNOHASHI SEISAKUSHO CO., LTD.	161
	SANTA ANA SCREW PRODUCTS INC	161
	SATURN FASTENERS, INC.	162

MIL-HDBK-57E (IS)



SYMBOL	COMPANY NAME	PAGE
	SHAMROCK FASTENER TECHNOLOGIES, LLC.	163
	SPS TECHNOLOGIES METALAC INDUSTRIA	169
	STELFAST FASTENERS, INC.	172
&	STILLWATER FASTENERS, INC.	173
	STRENKERT MACHINE SHOP INC.	173
	SUNRISE PRECISION MFG.	174
	SUPERIOR TECHNOLOGY	174
	SUPREME SCREW PRODUCTS, INC.	174
	TAIYO NUT MFG. CO., LTD.	175
	TECH WELDING AND MACHINE CO.	176
	TENS MACHINE CO., INC.	177
	TFI AEROSPACE CORPORATION	178
	TOPURA CO., LTD.	180
	TOPURA CO., LTD.	180
	TRI STATE TOOL & DIE CO.	182
	UNITED BOLT & SCREW CORP.	185
	UNITED STEEL & FASTENERS INC.	186
	WHAIL BOLT IND. CO., LTD	194
	XCEL MFG., INC.	197
• (a dot)	CINCH-MONADNOCK	46
• (a dot) - (radial line)	DECKER MANUFACTURING CORP	52
• (a dot)	MONADNOCK COMPANY, THE	128
•• (2 dots)	BELL FASTENERS	27
•• (2 dots)	BRISTOL INDUSTRIES	32
	CUTTING EDGE ENTERPRISE, LLC	50
•• (2 dots)	NORTH EAST FASTENERS	135
•• (2 dots)	STILLWATER FASTENERS, INC.	173

SYMBOL	COMPANY NAME	PAGE
	CSM FASTENER PRODUCTS	49
	EMP MANUFACTURING CO.	61
	ERICO FASTENING SYSTEMS	63
	WOLVERINE NUT CO.	197
3 dots, centered on corner, equally spaced		
•••• 4 dots inline or radial	CAMCAR DIVISION OF TEXTRON INC.	38-40
	CAMCAR LLC	41
//	BRISTOL LOCKNUT CO.	33
	3 radial lines CAMCAR DIVISION OF TEXTRON INC.	38-40
	METALCRAFTERS	123
= 2 parallel lines	CAMCAR DIVISION OF TEXTRON INC.	38-40
 Three parallel lines sprakok insert products only	MICRODOT INC.	124
	AMERIFAST CORP.	15
	GREER STOP NUT	78
Manufacturer identification: 2 raised ribs in (2) crimp depressions 1 raised rib in (1) crimp depression		
"Dimple" trademark	PENN ENGINEERING & MANUFACTURING CO.	143
Notches or Stakes cut into corners of nut	EVERLOCK FASTENING SYSTEMS	64,65
2, 3, or 6 dots on corner of nut 4 or 6 dots on flange of flange nuts	FEDERAL SCREW WORKS	69
	INDUSTRIAL & AUTOMOTIVE FASTENERS	91
Company I.D.: 2 single & 1 double slash		
Dots, slashes, and dots with slashes 2 - 8	R B & W CORPORATION	151, 152
Dots, slashes, and dots with slashes 2 - 8	STELCO FASTENER & FORGING CO.	172

MIL-HDBK-57E (IS)

SYMBOL	COMPANY NAME	PAGE
<p>Raised or indented marks</p> <p>Under head Top of head Slotted hexhead (top of head)</p>	INDUSTRIAL FASTENERS CORP.	92
<p>4 - 7 DOTS</p>	LAMSON AND SESSIONS OF CANADA LTD.	105
<p>3, 4 or 6 equally spaced stakes</p>	INDUSTRIAL NUT CORP.	92
<p>120° INCLUDED ANGLE RAISED.</p> <p>INDENTED HEX HDS. AND INDENTED HEX WASHER HDS.</p>	LEWIS SREW COMPANY	109
<p>3-DASH MARKS 120° APART RAISED</p> <p>UNDER HEAD UPON REQUEST "HIGH-COUNTERSINK HEADS ONLY"</p>	LEWIS SREW COMPANY	109
<p>Flange nuts less lock and with Uni-Torque® lock Two raised bars</p>	MACLEAN-FOGG CO.	116
<p>TWO RAISED BARS</p>		
<p>Three raised or depressed lines</p>	THIANT (BOULONNERIE DE SA)	179
<p>Hex nuts and Uni-Torque® locknuts</p>	MACLEAN-FOGG CO.	116
	PACIFIC FASTENERS, INC.	141
	TEXTRON FASTENING SYSTEMS	178
	VMC INDUSTRIES, INC.	189
<p>Two lines in three pads</p>		
<p>Green nylon insert</p>	GREER STOP NUT	75
<p>Green nylon insert</p>	EVERLOCK FASTENING SYSTEMS	65
<p>Red nylon insert</p>	ELASTIC STOP NUT & ESNA	60, 116
<p>Tan nylon insert</p>	VMC INDUSTRIES, INC.	183
<p>Yellow nylon insert</p>	ABBOTT INTERFAST CORP.	2

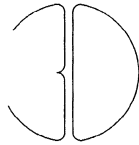
SYMBOL	COMPANY NAME	PAGE
	ELCO INDUSTRIES, INC.	60
	GRIPCO, DIVISION OF BLACK & DECKER	78
	RAMCO SPECIALTIES, INC.	148
	RIPPA PRODUCTS	156
<p>2 notches for slotted heads only</p>	SOUTHERN FASTENING SYSTEMS	167
	WOLVERINE MACHINE PRODUCTS CO.	196
<p>Straight knurled nuts with an unknurled band adjacent to the bearing surface on socket heads. The diameter over the straight knurl does not exceed the band. There may be 2 or 3 grooves</p>	SPS TECHNOLOGIES	169
<p>A raised or depressed triangle pointing from the wrenching flat toward thread on nut products.</p>	SPS TECHNOLOGIES	169
<p>Blue nylon insert</p>	INDUSTRIAL NUT CORP.	92
<p>Blue nylon locking element</p>	NYLOK CORP.	137
<p>Blue - nylon® hexagon locking element</p>	PENN ENGINEERING & MANUFACTURING CO.	143
<p>Square insert in floating fasteners</p>	PENN ENGINEERING & MANUFACTURING CO.	143

<p>3 V FASTENERS 320 REED CIRCLE CORONA, CA 92879-1349</p>  <p>CAGE code: 1ER65 <u>1/</u></p>	<p>A & M AEROSPACE, INC. 2332 SOUTH DELAWARE DENVER, CO 80223-4321</p> <p>A & M <u>A</u> A/M A&M M</p> <p>CAGE code: 6Z800 <u>1/</u></p>
<p>3D MACHINE COMPANY, INC. 5586 EAST LA PALMA AVENUE ANAHEIM, CA 92807-2108</p>  <p>CAGE code: 1K6P6 <u>2/</u></p>	<p>A & N PRECISION INDUSTRIES 65 FIRST STREET NEW ROCHVILLE, NY 10801-6118</p>  <p>CAGE code: 9Y423 <u>2/</u></p>
<p>A & E MACHINED PRODUCTS 93 PECK HILL ROAD JOHNSTON, RI 02919</p> <p style="text-align: center;">AE</p> <p>CAGE code: 3MAH6 <u>2/</u></p>	<p>A & R MFG CORP. 1281 JOHN FITCH BLVD. SOUTH WINDSOR, CT 06074</p> <p style="text-align: center;">AR</p> <p>CAGE code: 3X841 <u>2/</u></p>
<p>A & G ENGINEERING CO., INC 4640 EAST LAPALMA ANAHEIM, CA 92807</p>  <p>CAGE code: 4N135 <u>2/</u></p>	<p>A & W SCREW MACHINE PRODUCTS, INC. 3131 KANSAS AVE RIVERSIDE, CA 92507</p> <p style="text-align: center;">AW</p> <p>CAGE code: 63035 <u>1/</u></p>

1/ Information published in this revision was verified by direct contact with manufacturers.

2/ Information not verified to be current, no response from manufacturer. Information identical to that published in MIL-HDBK-57, Revision B.

A. AGRATI S.P.A.
 VIA PAIVE 28/30
 20050 VEDUGGIO CON COLZANO
 MILANO, ITALY

Plant
 AGRATI CORP.
 925 Brewster Street
 Bridgeport, CT 06605



socket
 head
 cap
 screw

CAGE code: A0698 2/

A. P. MILLS INDUSTRIES FOR
 THE BLIND
 346 ST. PAUL AVE.
 P.O. BOX 2175
 MEMPHIS, TN 38101

(See WEST TENNESSEE LIONS BLIND INDUSTRIES
 INC.)

APMI

CAGE code: 5L565 2/

A-1 NUT AND BOLT CO, INC
 DIVISION OF GREEN CO. PACIFIC INC.
 3433 S. MALT AVENUE
 COMMERCE, CA 90040

A 1

CAGE code: 1M493 2/

A-1 THREAD ROLLING CO., INC.
 4933 MASON ST.
 SOUTH GATE, CA 90280

A-1

CAGE code: 3N586 2/

AAP ACQUISITION CORP
 2100 ENTERPRISE PKWY
 TWINSBURG, OH 44087-2212

(SEE ACHILLES AEROSPACE PRODUCTS)

A

CAGE code: 0H380 2/

AASTRO ENGINEERING
 1382 CORONADO AVE
 LONG BEACH, CA 90804

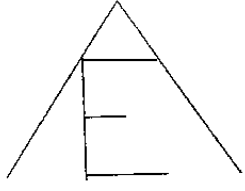

CAGE code: 01AL8 2/

ABBOTT INTERFAST CORP.
 190 ABBOTT DRIVE
 WHEELING, IL 60090

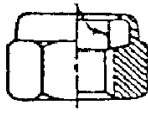

Yellow nylon insert identifies Abbott-Interfast
 Corp.
 as manufacturer



CAGE code: 08928 1/

1/ Information published in this revision was verified by direct contact with manufacturers.
 2/ Information not verified to be current, no response from manufacturer. Information identical to that published in MIL-HDBK-57, Revision B.

<p>ABBOTT, PETER (AEROSPACE) 1982 LTD. 6 REPTON CLOSE BURNT MILLS, BASILDON, ESSEX SS13 ILE UNITED KINGDOM</p> <p style="text-align: center;">PAM PAM PAM</p> <p>CAGE code: 0WL73 <u>2/</u></p>
<p>ABC TOOL AND DIE ENGINEERING & MANUFACTURING LLC 197 WALLIS STREET UNIT C EUGENE, OR 97402-5301</p> <p style="text-align: center;">No artwork for marking. Marks whatever the customer specifies.</p> <p>CAGE code: 0XJF0 <u>1/</u></p>
<p>ABSCOA INDUSTRIES 1071 WEST ARBOR VITAE ST. INGLEWOOD, CA 90301</p> <p style="text-align: center;">AB</p> <p>CAGE code: <u>2/</u></p>
<p>ACCUFORM, INC. P.O. BOX 307 BUS. HWY. 36 WEST MACON, MO 63552</p> <p style="text-align: center;">AF AF</p> <p>CAGE code: <u>2/</u></p>

<p>ACCURATE AUTOMATIC PARTS CO. 2885 S. 163RD ST. NEW BERLIN, WI 53151</p> <p style="text-align: center;">AP</p> <p>CAGE code: 5S202 <u>2/</u></p>
<p>ACCURATE PRECISION FASTENERS, INC. P.O. BOX 5239 ENGLEWOOD, NJ 07631</p> <p style="text-align: center;">Plant 20 HONECK ST. ENGLEWOOD, NJ 07631</p> <p style="text-align: center;">A</p> <p>CAGE code: 28977 <u>2/</u></p>
<p>ACCURATE SCREW MACHINE CO. (DBA ASM) P.O. 10095 10 AUDREY PL FAIRFIELD, NJ 07004-3402</p> <p style="text-align: center;">Plant 19 Baltimore St. Nutley, NJ 07110</p> <p style="text-align: center;">AMSCO 5/16 LONG X 1/16 HIGH X .010 DEEP</p> <p>CAGE code: 51506 <u>2/</u></p>
<p>ACCURATE THREADED FASTENERS, INC. DIVISION OF BEATRICE FOODS CO. (new company name see ATF, INC.) 3550 WEST PRATT AVE LINCOLNWOOD, IL 60645</p> <p style="text-align: center;"> </p> <p>CAGE code: 95110 <u>1/</u></p>

1/ Information published in this revision was verified by direct contact with manufacturers.

2/ Information not verified to be current, no response from manufacturer. Information identical to that published in MIL-HDBK-57, Revision B.

<p>ACCURATE THREADED PRODUCTS CO. 280 HARTFORD AVENUE NEWINGTON, CT 06111</p> <p style="text-align: center;">1A249</p> <p>CAGE code: 1A249 <u>2/</u></p>	<p>ACE GRINDING & MFG. OF TEXAS (formally ACE G & M CO. OF TEXAS) 2610 AERO DR. GRAND PAIRIE, TX 75052</p> <p style="text-align: center;">AGC</p> <p><i>Plant (plant closed)</i> <i>ACE GRINDING & MFG.</i> <i>4937 EAST SLAUSON AVENUE</i> <i>MAYWOOD, CA 90270</i> <i>CAGE code: 2N509</i></p> <p style="text-align: center;">AGM</p> <p>Plant (see SHAW PRECISION GRINDING AND THREAD ROLLING) SHAW PRECISION GRINDING 6503 W. FRYE RD. CHANDLER, AZ 85226</p> <p style="text-align: center;">SPG</p> <p>CAGE code: 5U074 <u>1/</u></p>
<p>ACCURATE TOOL CO., INC. 891 FERNHILL RD WEST CHESTER, PA 19380 - 4282</p> <p style="text-align: center;">A+</p> <p>CAGE code: 7N957 <u>1/</u></p>	<p>ACE PRECISION INDUSTRIES, INC. 925 MOE DRIVE AKRON, OH 44310-2518</p> <p style="text-align: center;">ACE</p> <p>CAGE code: 3DTZ2 <u>2/</u></p>
<p>ACCU-TECH MANUFACTURING AND SUPPORT, INC. 8875 EAST AVENUE MENTOR, OH 44060</p> <p style="text-align: center;">Accu-TECH MFG. & SUPPORT INC.</p> <p>CAGE code: 1LLG8 <u>2/</u></p>	<p>ACHILLES AEROSPACE PRODUCTS, INC. 2100 ENTERPRISE PKWY TWINSBURG, OH 44087-2212</p> <p>(SEE AAP)</p> <p style="text-align: center;">A</p> <p>CAGE code: 0H380 <u>2/</u></p>
<p>ACCUTOOL (SUBCON TOOL/ACCUTOOL MACHINE GROUP INC. DBA ACCUTOOL) SEE SUBCON TOOL 5301 IROQUOIS AVENUE ERIE, PA 16511-2529</p> <p style="text-align: center;">01FO</p> <p>CAGE code: 1UXM0 <u>1/</u></p>	

1/ Information published in this revision was verified by direct contact with manufacturers.

2/ Information not verified to be current, no response from manufacturer. Information identical to that published in MIL-HDBK-57, Revision B.

ACI
301 W. WILSON
P.O. BOX 398
OTTAWA, KS 66067

ACI

CAGE code: 0AV61 2/

ACIMET MFG.
1710 CLARKSTONE RD.
CLEVELAND, OH 44112



CAGE code: 6V869 2/

ACME MACHINE PRODUCTS
500 SOUTH VARNEY STREET
BURBANK, CA 91502







CAGE code: 4M256 2/

ACME RIVET & MACHINE CORP.
50 EMMETT ST.
BRISTOL, CT 06010

CAGE code: 34482 2/

ACME SCREW COMPANY
1201 W. UNION AVE
WHEATON, IL 60187-4879

 *Carbon steel*
  *430 stainless steel*
 *410 stainless steel*
  *305 stainless steel*

CAGE code: 35EX5 2/

ACRODYNE MFG CO.
(DIVISION OF MACK INTERNATIONAL OPERATIONS)
41 KINGSTON AVE
COLUMBUS, OH 43207-2438



CAGE code: 9Y179 2/

ACUFAST AIRCRAFT PRODUCTS
12424 GLADSTONE AVE.
SYLMAR, CA 91342

AF

CAGE code: 4GP55 1/







ADAMS INDUSTRIES, INC.
(A SUB OF BANNER INDUSTRIES INC.)
1160 SOUTH ST
WINDSOR LOCKS, CT 06096

ABE

CAGE code: 33823 2/









1/ Information published in this revision was verified by direct contact with manufacturers.

2/ Information not verified to be current, no response from manufacturer. Information identical to that published in MIL-HDBK-57, Revision B.

<p>ADAMS, EARL M. CO. 100 PECK HILL RD. JOHNSTON, RI 02919</p>   <p>CAGE code: 07123 <u>2/</u></p>	<p>ADVANCE PATTERN CORP. 18564 FITZPATRICK DETROIT, MI 48228</p> <p>MFR 29839</p> <p>CAGE code: 29839 <u>2/</u></p>
<p>ADC COMMUNICATIONS CORP. 17528 STUDEBAKER RD. CERRITOS, CA 90703-2637</p>   <p>CAGE code: 9X383 <u>2/</u></p>	<p>ADVANCED CNC MANUFACTURING 7303 124TH AVENUE NORTH LARGO, FL 33773</p> <p>A</p> <p>CAGE code: 1YDC9 <u>1/</u></p>
<p>ADI MANUFACTURING, INC. 33 HAMMOND, BLDG 201 IRVINE, CA 92718</p> <p>Plant 1243 TRANSIT STREET POMONA, CA 91766</p> <p>MC K</p> <p>CAGE code: 0YCU4 <u>2/</u></p>	<p>ADVANCED MACHINING & FABRICATING, INC. 11212 E. 112TH ST. N. OWASSO, OK 74055-5421</p> <p>a</p> <p>CAGE code: 0BD96 <u>1/</u></p>
<p>ADJUSTABLE BUSHING CORP. 8330 LANKERSHIM BLVD. NORTH HOLLYWOOD, CA 91605</p>   <p><i>Panel fastener</i> <i>Quick-acting pins</i></p> <p>CAGE code: 3V407 <u>2/</u></p>	<p>ADVANCED MACHINING TECHNOLOGIES PO BOX 3351 WARMINISTER, PA 18974</p> <p>Plant 220 JACKSONVILLE RD. HATBORO, PA 19040</p> <p>0F0Y2</p> <p>CAGE code: 0F0Y2 <u>1/</u></p>
<p>ADOM ENGINEERING 131 AVCO ROAD HAVERHILL, MA 01835-5956</p> <p>AD adm (used formerly)</p> <p>CAGE code: 02GZ1 <u>1/</u></p>	<p>ADVANCED PLASTICS, INC. DBA ADVANCED MACHINING & FABRICATING, INC. 11212 E. 112th ST. N. OWASSA, OK 74055-5421</p> <p>ap a</p> <p>CAGE code: 45339 <u>1/</u></p>

1/ Information published in this revision was verified by direct contact with manufacturers.

2/ Information not verified to be current, no response from manufacturer. Information identical to that published in MIL-HDBK-57, Revision B.

<p>AERCO RESEARCH 295 OLD COUNTRY ROAD SUITE 10 SAN CARLOS, CA 94070-6240</p>  <p>CAGE code: 0KMN9 <u>1/</u></p>	<p>AERO ENGINEERING AND MANUFACTURING CO. OF CALIFORNIA (DBA AERO ENGINEERING) 28217 AVENUE CROCKER VALENCIA, CA 91355-1249</p>  <p>CAGE code: 17772 <u>1/</u></p>
<p>AERO BUSHING AND COMPONENT 15201 PIPELINE LN. HUNTINGTON BEACH, CA 92649</p>  <p>CAGE code: <u>2/</u></p>	<p>AERO MECHANICAL FASTENING SYSTEMS 15481 WEST 110TH AVE SHAWNEE MISSION, KS 66219</p>  <p>CAGE code: 1FY45 <u>2/</u></p>
<p>AERO COMPONENTS CO. 5124 KALTENBRUN RD. FORT WORTH 76119 - 6400</p>  <p>CAGE code: 59213 <u>2/</u></p>	<p>AEROBOLT MANUFACTURING, INC. 4736 FELSPAR STREET RIVERSIDE, CA 92509-3068</p>  <p>CAGE code: 08PH2 <u>2/</u></p>
<p>AERO DYNAMIC MACHINING, INC. 11791 MONARCH STREET GARDEN GROVE, CA 92841-1818</p>  <p>CAGE code: 1KSM2 <u>2/</u></p>	<p>AERO-FAB, INC. 8420 RED OAK STREET RANCHO CUCAMONGA, CA 91730</p>  <p>CAGE code: 0CAC0 <u>2/</u></p>

1/ Information published in this revision was verified by direct contact with manufacturers.

2/ Information not verified to be current, no response from manufacturer. Information identical to that published in MIL-HDBK-57, Revision B.

AEROFAST SUPPLY
405 W 20TH ST
SAN PEDRO, CA 90731

A

CAGE code: 2T830 2/

AEROMAX INDUSTRIES, INC.
DBA AEROMAX INTERNATIONAL
9546 TOPANGA CANYON BLVD.
CHATSWORTH, CA 91311-4011

AX

CAGE code: 40581 1/

AEROSPACE MANUFACTURING
P.O. BOX 3398
WALLINGTON, NJ 07057-1148

Plant
80 VAN WINKLE AVE.
WALLINGTON, NJ 07057-1148

AM

CAGE code: 0E0Z8 1/

AEROSPACE MARINE SPECIALTY
FASTENERS & FITTINGS INC. DBA AMS
FASTENERS
1645 WEST 135ND STREET
GARDENA, CA 90249-2505

AMS **A M S**

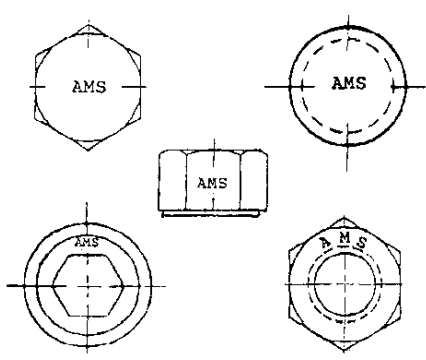

CAGE code: 1FGH9 2/

AEROSPACE PRODUCTS
(DIV OF APCOA FASTENERS, INC)
903 E. OHIO STREET
P. O. BOX 796
INDIANAPOLIS, IN 46202

APCO

CAGE code: 17140 2/

AEROSPACE PRODUCTS CO. DIV WBH
(FORMERLY APCOA FASTENERS, INC.)
P.O. BOX 796
INDIANAPOLIS, IN 46206-0796







Plant
123 NORTH PINE STREET
INDIANAPOLIS, IN 46202-3844

AP

CAGE code: 59736 1/







1/ Information published in this revision was verified by direct contact with manufacturers.

2/ Information not verified to be current, no response from manufacturer. Information identical to that published in MIL-HDBK-57, Revision B.

<p>AEROSPACE PRODUCTS, INC. 5435 PERKINS RD. BEDFORD HEIGHTS, OH 44146</p> <p style="text-align: center;">A</p> <p>CAGE code: <u>2/</u></p>	<p>AEROTECH FASTENERS, INC. ONE RIDGE ROAD PUTNAM, CT 06260</p> <p style="text-align: center;"></p> <p>CAGE code: 0TD46 <u>1/</u></p>
<p>AEROSPACE RIVET MFG CORP 8535 DICE ROAD SANTA FE SPRINGS, CA 90670</p> <p style="text-align: center;"></p> <p>CAGE code: 64728 <u>2/</u></p>	<p>AEROWIND CORPORATION 1959 JOHN TOWERS AVENUE EL CAJON, CA 92020-1117</p> <p style="text-align: center;">A </p> <p>CAGE code: 1N021 <u>1/</u></p>
<p>AEROSTAR ENGINEERING & MANUFACTURING COMPANY 25514 S. FRAMPTON AVENUE HARBOR CITY, CA 90710-2907</p> <p style="text-align: center;"></p> <p>No longer a fastener manufacturer</p> <p>CAGE code: 0MXJ2 <u>2/</u></p>	<p>AF FASTENERS LIMITED UNIT 14 & 15 GLOSSOP BROOK BUSINESS PARK, GLOSSOP, DERBYSHIRE SK13 7AJ, UNITED KINGDOM</p> <p style="text-align: center;">J</p> <p>CAGE code: <u>1/</u></p>
<p>AEROSTAR FASTENER CORP. 712 W LACY ST P.O. BOX 2201 PALESTINE, TX 75802</p> <p style="text-align: center;"></p> <p>CAGE code: 0T218 <u>2/</u></p>	<p>AFAB PRECISION MACHINING 20742 LINEAR LANE LAKE FOREST, CA 92630</p> <p style="text-align: center;"></p> <p>CAGE code: 1GSW1 <u>2/</u></p>



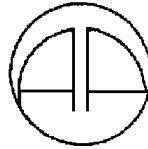

^{1/} Information published in this revision was verified by direct contact with manufacturers.

^{2/} Information not verified to be current, no response from manufacturer. Information identical to that published in MIL-HDBK-57, Revision B.

<p>AFI INDUSTRIES, INC. 475 E. KEHOE BLVD CAROL STREAM, IL 60188</p> <p> </p> <p>CAGE code: 33PQ1 <u>1/</u></p>	<p>AIR-COM, INC. 18105 S. HOBART BLVD. GARDENA, CA 90248-3617</p> <p></p> <p>CAGE code: 2Y870 <u>2/</u></p>
<p>AIHARA SEIBYO CO LTD 2084 SHIN-MACHI TANO-GUN, GUNMA, JAPAN 370-13</p> <p>ICHO</p> <p>CAGE code: <u>2/</u></p>	<p>AIRCRAFT ENGINEERING PRODUCTS, INC. 2 ACKERMAN AVENUE CLIFTON, NJ 07011</p> <p>AEP AEP</p> <p>CAGE code: <u>2/</u></p>
<p>AIR INDUSTRIES CORPORATION 12570 KNOTT STREET GARDEN GROVE, CA 92841-3932</p> <p></p> <p>CAGE code: 06725 <u>1/</u></p>	<p>AIRCRAFT FUELSEAL FASTENERS, INC. (AEROLITE BLIND RIVET DIVISION) 5271 ARGOSY AVENUE HUNTINGTON BEACH, CA 92649</p> <p></p> <p>CAGE code: 4K209 <u>2/</u></p>
<p>AIR PARTS MFG. CO. 1117 HARRISON AVE ARLINGTON, TX 76011</p> <p></p> <p>CAGE code: 8R401 <u>2/</u></p>	<p>AIRDROME PARTS CO. 3251 SCHNIEDER ROAD S.E. P.O. BOX 1867 NORTH CANTON, OH 44720</p> <p></p> <p>CAGE code: <u>2/</u></p>

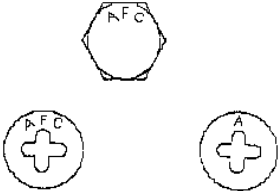





1/ Information published in this revision was verified by direct contact with manufacturers.

2/ Information not verified to be current, no response from manufacturer. Information identical to that published in MIL-HDBK-57, Revision B.

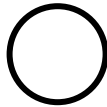
<p>AIRFASCO, INC. 2655 HARRISON AVE SW. CANTON, OH 44706-3047</p>  <p>CAGE code: 3Z958 <u>2/</u></p>	<p>ALBAR MACHINE CORPORATION RR3 BOX 2463 EFFORT, PA 18330-9450</p> <p style="text-align: center;">AMC</p> <p>CAGE code: 44248 <u>1/</u></p>
<p>AIW-ALTON INC. 1475 PALISADO AVE. WINDSOR, CT 06095-5140</p>  <p>CAGE code: 84027 <u>2/</u></p>	<p>ALCO MACHINE CO. 27 SEARING AVENUE HARRISON, NJ 07029</p>  <p>CAGE code: 2T918 <u>2/</u></p>
<p>AKKO FASTENER, INC. 6855 CORNELL RD. CINCINNATI, OHIO 45242</p>  <p>CAGE code: 3M2H6 <u>1/</u></p>	<p>ALCOA FASTENING SYSTEMS 3016 WEST LOMITA BLVD. TORRANCE, CA 90505</p> <p>plants:</p> <p>see CAMLOC PRODUCTS</p> <p>see HUCK INDUSTRIAL PRODUCTS</p> <p>see HUCK AEROSPACE PRODUCTS</p> <p>see KAYNAR PRODUCTS</p> <p>see KELOX/MICRODOT PRODUCTS</p> <p>see MECAERO PRODUCTS</p> <p>see RAM PRODUCTS</p> <p>see ROSAN PRODUCTS</p> <p>see SIMMONDS PRODUCTS</p> <p>see TRIDAIR PRODUCTS</p> <p>see VOI-SHAN PRODUCTS</p> <p>CAGE code: 15653 <u>1/</u></p>
<p>ALAN, JEFFREY, MFG. & ENGR. 8625 LAPEER ROAD P.O. BOX # 8 GOODELLS, MI 48027-9766</p> <p style="text-align: center;">3D531</p> <p>CAGE code: 3D531 <u>2/</u></p>	
<p>ALARD MACHINE PRODUCTS 1629 WEST 132ND STREET GARDENA, CA 90249-2005</p>  <p>CAGE code: 1FMQ2 <u>1/</u></p>	

1/ Information published in this revision was verified by direct contact with manufacturers.

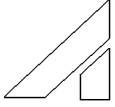
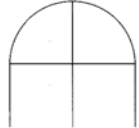
2/ Information not verified to be current, no response from manufacturer. Information identical to that published in MIL-HDBK-57, Revision B.

<p>ALCOA GLOBAL FASTENERS INC 13001 EAST TEMPLE AVE LA PUENTE, CA 91746-1417</p>  <p>CAGE code: 06950 <u>2/</u></p>	<p>ALL QUALITY SPARES, INC. 3 EAST BISHOP STREET WATERFORD, CT 06385</p>  <p>CAGE code: 1VGA2 <u>1/</u></p>
<p>ALEXANDER MANUFACTURING COMPANY INC. DBA METRO TOOL & MANUFACTURING CO. 2402 ARKANSAS LANE GRAND PRAIRIE, TX 75052-7203</p>  <p>CAGE code: 2M919 <u>2/</u></p>	<p>ALLFAST FASTENING SYSTEMS, INC. 15200 E DON JULLIAN RD P.O. BOX 3166 CITY OF INDUSTRY, CA 91745-1098</p>  <p>CAGE code: 53551 <u>1/</u></p>
<p>ALL MANUFACTURERS INC. DBA HARPER AEROSPACE FASTENERS 2900 PALISADES DR CORONA, CA 92880 – 9429</p>  <p>CAGE code: 57472 <u>2/</u></p>	<p>ALLIED NUT & BOLT CO., INC. 520 HERTZOG BOULEVARD P.O. BOX 670 KING OF PRUSSIA, PA 19406-2667</p>  <p>CAGE code: 4S191 <u>2/</u></p>
<p>ALL PINS MANUFACTURING P.O. BOX 137 WILSEYVILLE, CA 95257</p> <p>plant 5549 POOR MANS WAY WILSEYVILLE, CA 95257</p>  <p>CAGE code: O8CZ5</p>	<p>ALLIED PRECISION PRODUCTS, INC. 600 SAN CHRISTOPHER DRIVE DUNEDIN, FL 34698-5095</p>  <p>CAGE code: 24249 <u>1/</u></p> <p>ALL-POWER MFG. CO. 13141 MOLETTE STREET SANTA FE SPRINGS, CA 90670-5500</p>  <p>CAGE code: 70265 <u>1/</u></p>

1/ Information published in this revision was verified by direct contact with manufacturers.

2/ Information not verified to be current, no response from manufacturer. Information identical to that published in MIL-HDBK-57, Revision B.

ALL-PRO FASTENER & RIVET MFG. CO.
10406 ENTERPRISE ST
P.O. BOX 1525
RANCHO CUCAMONGA, CA 91730

AP

CAGE code: 1FH10 2/

ALL-STATES INC.
1801 WEST FOSTER AVE.
CHICAGO, IL 60640

ALL-STATES LOGO

=
ALL-STATES
IDENTIFICATION MARK

CAGE code: 26863 2/

ALPHA BOLT CO.
1524 EAST 14 MILE ROAD
MADISON HEIGHTS, MI 48071

ABC

I

CAGE code: 0R8B6 2/

Continued

Continued

ALPHA BOLT CO.

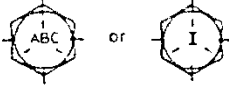
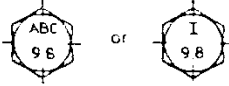
 or 

GRADE 5 BOLT PROPERTY CLASS 9.8
METRIC BOLTS

 Roman numeral "I" shown on special bolts

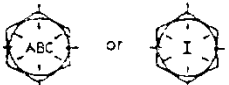
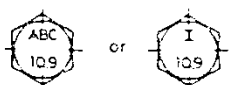
 or 

GRADE 8 BOLT PROPERTY CLASS 10.9
METRIC BOLTS

CAGE code: 0R8B6 2/

ALPHA FASTENERS
154 EAST MERRICK ROAD
FREEPORT, NY 11520

**A
F**

CAGE code: 1UJ18 1/

ALPHA MACHINING PRODUCTS &
DEVELOPMENT
8651 PRODUCTION AVENUE
SAN DIEGO, CA 92126

Plant
7929 SILVERTON AVENUE
SUITE 610
SAN DEIGO, CA 92126

α

CAGE code: 3D6Q0 2/

1/ Information published in this revision was verified by direct contact with manufacturers.

2/ Information not verified to be current, no response from manufacturer. Information identical to that published in MIL-HDBK-57, Revision B.

ALPINE MACHINE & TOOL CORP.
42 BERGENLINE AVE.
WESTWOOD, NJ 07675

AMT - I

AMT x x x x - x x x x



CAGE code: 67339 2/

ALPS SEIKO CO. LTD.
41 HIGASHI-KANAE, KANAE
IIDA-SHI, NAGANO PREF.
395-0817, JAPAN

Plant
LIDA FACTORY
524-1, SHIMOTONOHKA
LIDA-SHI, NAGANO PREF.
395-0154 JAPAN

A





CAGE code: 1/

AMACON CORP.
49 ALDER STREET
WEST BABYLON, NY 11704



CAGE code: 54330 2/

AMANDA BENT BOLT CO.
1120 C I C DR.
LOGAN, OH 43138-9153



CAGE code: 22382 2/

AMATOM ELECTRONIC HARDWARE
(DIVISION OF QUINCY TECHNOLOGIES,
INC.)
5 PASCO HILL ROAD
CROMWELL, CT 06416-1012

A
M
A
T
O
M

AMATOM

CAGE code: 1YGB8 2/

AMERICAN AIRCRAFT PARTS
MANUFACTURING COMPANY
17917 MASONIC
FRASER, MI 48026

99106

CAGE code: 99106 2/

AMERICAN ELECTRIC
(CONSTRUCTION MATERIALS GROUP)
1555 LYNNFIELD ROAD
MEMPHIS, TN 38119

(SEE THOMAS & BETTS CORP - CAGE 56501)

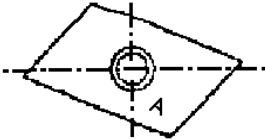



CAGE code: 1/

1/ Information published in this revision was verified by direct contact with manufacturers.

2/ Information not verified to be current, no response from manufacturer. Information identical to that published in MIL-HDBK-57, Revision B.

AMERICAN FASTENER & SPECIALTY CO.
5900 PARK AVE.
CLEVELAND, OHIO 44105

CAGE code: 2/

AMERICAN INTERNATIONAL AERO MFG INC.
6973 SOUTH 300 WEST
MIDVALE, UTAH 84047





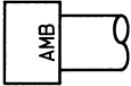

CAGE code: 0RBVB 2/

AMERICAN METAL BEARING COMPANY
7191 ACACIA AVENUE
GARDEN GROVE, CA 92841

AMB



HEX SOCKET HEAD SCREW HEX SOCKET HEAD SCREW

THREAD OR STUD END HEX HEAD SCREW OR BOLT HEX NUT HEX NUT

CAGE code: 70508 1/

AMERICAN QUALITY INDUSTRIES
(FASTENER DIVISION)
411 BURNHAM STREET
EAST HARTFORD, CT 06108

GRADE 8 BOLT GRADE 5 BOLT

CAGE code: 1P581 1/

AMERIFAST CORP.
104 SYLVANNA RD.
SOUTH PLAINSFIELD, NJ 07080-1448

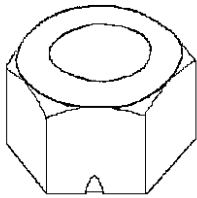

CAGE code: 0H4SO 1/



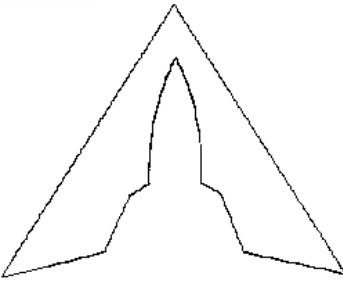





AMERITECH FASTNER MFG INC.
DIVISION OF LONE STAR FASTENERS, LP
6606 N GESSNER
HOUSTON, TX 77040



CAGE code: 0EUH2 1/

1/ Information published in this revision was verified by direct contact with manufacturers.



2/ Information not verified to be current, no response from manufacturer. Information identical to that published in MIL-HDBK-57, Revision B.

<p>AMMAC, INC. 6000 SUSQUEHANNA PLAZA YORK, PA 17406</p>  <p>CAGE code: 0NHU1 1/</p>	<p>ANILLO INDUSTRIES, INC. 2090 N. GLASSELL P.O. BOX 5586 ORANGE, CA 92865-3306</p>  <p>CAGE code: 10630 1/</p>
<p>ANATASE PRODUCTS (DIV OF HENWAY INC) 1314 GOODRICK DR TEHCHPI, CA 93561</p>  <p>CAGE code: 0MXJ8 1/</p>	<p>ANOTHER SCREW MACHINE PRODUCT EMERALD INDUSTRIAL PARK BOX 425 PONDERAY, ID 83852</p> <p style="text-align: center;">BEI</p> <p>CAGE code: 05RQ3 2/</p>
<p>ANCHOR BOLT & SCREW CO. 2001 N. CORNWELL MELROSE PARK, IL 60160-1081</p>  <p>Hex cap and indented hex screws.</p>  <p>Machine screws and Other products - 3 dots under head 120° apart</p> <p>CAGE code: 9C864 2/</p>	<p>A-ONE MACHINE COMPANY R.R.1, BOX 1660 HOP BOTTOM, PA 18824</p>  <p>CAGE code: 0AV84 1/</p>
<p>ANDERSON FORGE & MACHINE 18500 S. W. PACIFIC HWY TUALATIN, OR 97062</p>  <p>CAGE code: 7X566 2/</p>	<p>APEL LTD. COUNTRESS AVE., STANLEY GREEN TRADING ESTATE CHEADLE HULME, CHESHIRE, SK8 6QU UNITED KINGDOM</p>  <p>CAGE code: K5640 2/</p>

1/ Information published in this revision was verified by direct contact with manufacturers.

2/ Information not verified to be current, no response from manufacturer. Information identical to that published in MIL-HDBK-57, Revision B.

<p>APEX MFG. CO. INC. 11686 TUXFORD ST SUN VALLEY, CA 91352-3134</p> <p style="text-align: center;">AP</p> <p>CAGE code: 2V343 <u>1/</u></p>
<p>APHEONIX CORPORATION 101 PECK HILL ROAD JOHNSTON, RI 02919</p> <p style="text-align: center;">AP</p> <p style="text-align: center;">PC</p> <p>CAGE code: 08TF3 <u>2/</u></p>
<p>ARCHER SCREW PRODUCTS 11341 MELROSE STREET FRANKLIN PARK, IL 60131</p> <p style="text-align: center;">+</p> <p>CAGE code: 1HXL9 <u>2/</u></p>
<p>ARCO SALES CO. 2211 WAKELING STREET P.O. BOX 23001 PHILADELPHIA, PA 19137-1214</p> <p style="text-align: center;">ASC</p> <p style="text-align: center;">ASC</p> <p>CAGE code: 5L063 <u>1/</u></p>

<p>ARDOR MFG. INC. 400 S. 1100 W. PROVO, UT 84603</p> <p style="text-align: center;"></p> <p>CAGE code: 0CTH5 <u>2/</u></p>
<p>ARGARWAL INDUSTRIES 370 MARSHALL HOUSE 25 STRAND ROAD CALCUTTA, INDIA 700 001</p> <p style="text-align: center;"></p> <p>CAGE code: <u>2/</u></p>
<p>ARJAY PRECISION, INC. 524 SULLIVAN AVE SUITE 15 SOUTH WINDSOR, CT 06074</p> <p style="text-align: center;">MFR - 72905</p> <p>CAGE code: 72905 <u>2/</u></p>

1/ Information published in this revision was verified by direct contact with manufacturers.

2/ Information not verified to be current, no response from manufacturer. Information identical to that published in MIL-HDBK-57, Revision B.

ARMSTRONG ATLAS BOLT
 STATION STREET
 DARLASTON, WEST MIDLANDS, WS10 8UL
 GREAT BRITIN

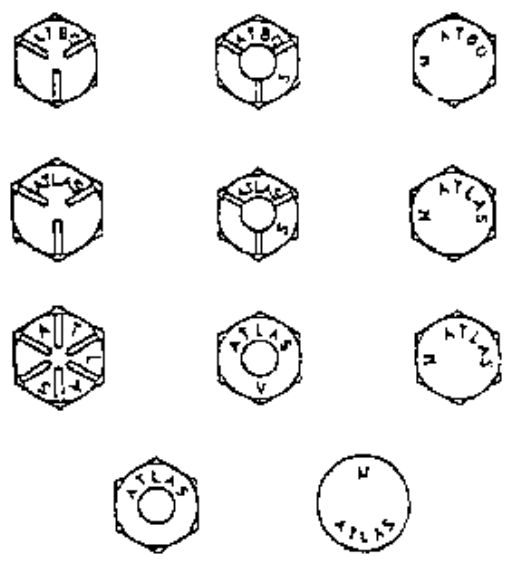

CAGE code: 2/

ARMSTRONG FASTENING SYSTEMS
 FOSTER STREET STONEFERRY
 BUSINESS PARK
 HULL, GREAT BRITIAN, HU8 8BT
 UNITED KINGDOM



Symbol may be depressed or raised

CAGE code: K1012 2/
 (Continued)

(Continued)

ARMSTRONG FASTENINGS LTD.
 FOSTER STREET STONEFERRY
 BUSINESS PARK
 HULL, GREAT BRITIAN, HU8 8BT
 UNITED KINGDOM

GSF



CAGE code: K1012 2/

ARNOLD KNIPPING GmbH
 58557 KIERSPE
 POSTFACH 14 48
 GUMMERSBACH, GERMANY 5270

AK
 KNIPPING

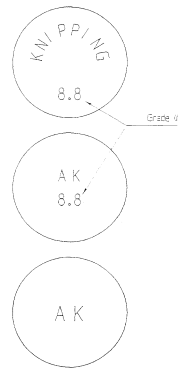





CAGE code: C4096 2/

ARNOLD UMFORMTECHNIK
 GMBH & CO. KG
 SINDRINGEN STR. 25
 FORCHTENBERG, 74670
 GERMANY

A

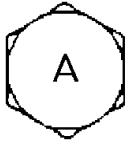

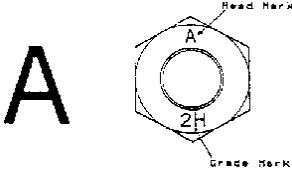

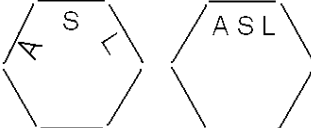
CAGE code: C3705 2/

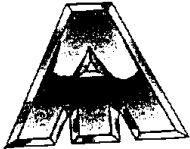

1/ Information published in this revision was verified by direct contact with manufacturers.
 2/ Information not verified to be current, no response from manufacturer. Information identical to that published in MIL-HDBK-57, Revision B.

<p>ARNOLD WRAGG (BOLTS & NUTS) LTD STANNINGTON ROAD STANNINGTON, SHEFFIELD ENGLAND, UK S6 6AG</p>  <p>CAGE code: U2935 2/</p>	<p>ASAHI SREWS MANUFACTURING CO., LTD 101 KAWAMATA HIGASHIOSAKA, JAPAN</p>  <p>CAGE code: 2/</p>
<p>ARROW SCREW & MACHINE WORKS 1037 GERMANTOWN AVENUE PHILADELPHIA, PA 19123-1629</p>  <p>CAGE code: 03632 2/</p>	<p>ASAI TEKKO CO. LTD 2-14 TAJIKA SHODKAI HIRKATA-SHI OSAKA, JAPAN 573</p>  <p>CAGE code: 2/</p>
<p>ARTISAN SPECIALIST TECH, INC. 439 HIGH STREET P.O. BOX 48060 PHILADELPHIA, PA 19144</p>  <p>CAGE code: 0RJ65 1/</p>	<p>ASI DESIGN & MANUFACTURING, INC. 1070 HARDEES DRIVE P. O. BOX 957 ABERDEEN, MD 21001</p>  <p>CAGE code: 32971 2/</p>
<p>ARVAN, INC. 14083 S NORMANDIE AVE GARDENA, CA 90249</p> <p style="text-align: center;">ARVAN, INC. TANSEY A/I</p> <p>CAGE code: 29965 2/</p>	<p>ASL MANUFACTURING INC. 60 S. POSADO CT. IVINS, UT 84738</p> <p style="text-align: center;">Plant 1074 W. 560N. ST. GEORGE, UT 84770</p>  <p>CAGE code: 1VED5 1/</p>

1/ Information published in this revision was verified by direct contact with manufacturers.

2/ Information not verified to be current, no response from manufacturer. Information identical to that published in MIL-HDBK-57, Revision B.

<p>ASSOCIATED TOOL CO., INC. 100 THOMAS DRIVE GADSDEN, AL 35901</p>  <p>CAGE code: 2U575 <u>2/</u></p>
<p>ATF, INC. (formerly Accurate Threaded Fasteners, Inc.) 3550 WEST PRATT AVENUE LINCOLNWOOD, IL 60712</p>  <p>CAGE code: 95110 <u>1/</u></p>
<p>ATLAS ENGINEERING, INC. (PENN ENGINEERING AND MFG. CO.) 5190 OLD EASTON RD. DANBORO, PA 18916</p>  <p>CAGE code: 46384 <u>1/</u></p>
<p>ATLAS SPECIALTY PRODUCTS (SEE CURTIS PRESTON ENTERPRISES INC.) 2299 E. WINSTON ROAD ANAHEIM, CA 92806</p>  <p>CAGE code: 0TP31 <u>1/</u></p>

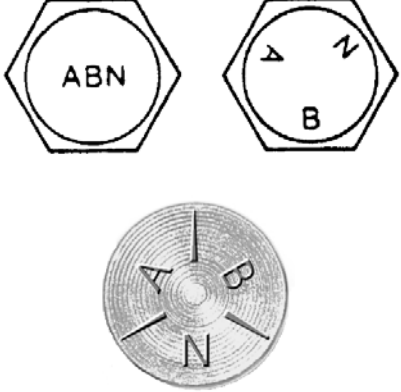
<p>AUGUST FRIEDBERG GMBH BELFORTER STRASSE 63 P. O. BOX 10 08 43 GELSENKIRCHEN, GERMANY 45884</p>  <p>CAGE code: <u>2/</u></p>
<p>AUGUST FRIEDBERG GmbH BELFORTER STRASSE 63 D-4650 GELSENKIRCHEN ROTTHAUSEN, GERMANY</p>  <p>CAGE code: <u>2/</u></p>
<p>AUTO BOLT AND NUT CO. 4619 PERKINS AVE CLEVELAND, OH 44103</p>  <p>CAGE code: 0CUJ9 <u>1/</u></p>

1/ Information published in this revision was verified by direct contact with manufacturers.
2/ Information not verified to be current, no response from manufacturer. Information identical to that published in MIL-HDBK-57, Revision B.

AUTOMATED MANUFACTURING
8009 AUGUSTA ROAD
PIEDMONT, SC 29673-9369

A M

CAGE code: 1URY9 2/

AUTOMATIC MACHINING AND MFG CO
DBA AMMAC INC
6000 SUSQUEHANNA PLZ
YORK, PA 17406





CAGE code: 0NHU1 2/

AUTOMATIC MANUFACTURING COMPANY
300 SHADELAND AVENUE
EAST PITTSBURGH, PA 15112-1499

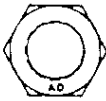
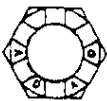

CAGE code: 18362 1/

AUTOMATIC SCREW MACHINE
PRODUCTS CO.
709 2ND AVE
P.O. BOX 1608
DECATUR, AL 35601

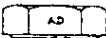
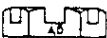
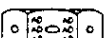
PLAIN:	SLOTTED:	DRILLED:
		
	OR	
		
AD	AD	AD

CAGE code: 92595 1/

AUTO SCREW, INC.
LYNBROCK RD. & EASTERN BLVD.
P.O. BOX 4968
BALTIMORE, MD 21220



CAGE code: 84253 2/

AVDEL INTERNATIONAL (AVDEL LTD)
HERTFORD, AL 7 1EZ
GREAT BRITIAN



CAGE code: 2/

AVIATION MANUFACTURING GROUP LLC
(SEE DBA FREEMAN CO., THE)
719 WALNUT ST
P. O. BOX 57
YANKTON, SD 57078-3542



CAGE code: 84596 1/

1/ Information published in this revision was verified by direct contact with manufacturers.

2/ Information not verified to be current, no response from manufacturer. Information identical to that published in MIL-HDBK-57, Revision B.

AVIBANK MANUFACTURING, INC.
 PRECISION CASTPARTS CORP.
 4650 SW MACADAM AVE. SUITE 440
 PORTLAND, OR 97239-4262

Plant
 AVIBANK MFG., INC.
 11500 SHERMAN WAY, P.O. BOX 9909
 NORTH HOLLYWOOD, CA 91609-1909

AB
ADB, ADBB, ADP,
LRA
AAP
AS
AV
AVIBANK, BALL-
LOK® , BLC, BLS,
PIP
AVL
AVK, ET, ETC, FN,
IT, ITC, MT, RT
ST
84256

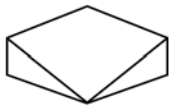

CAGE code: 84256

1/

AVK INDUSTRIES PRODUCTS INC.
 25323 RYE CANYON RD
 VALENCIA, CA 91355



CAGE code: 2K288

2/

AZTECH ENGINEERING, INC.
 1424 CENTRE CIR.
 DOWNERGROVE, IL 60515



CAGE code: 0W426

2/

B & B SPECIALTIES INC.
 4321 E. LAPLMA AVE.
 ANAHIEM, CA 92807

(see GS AEROSPACE)

1) PRIMARY - **BB**

2) SECONDARY - **62206**

CAGE code: 62206

1/

Continued

1/ Information published in this revision was verified by direct contact with manufacturers.

2/ Information not verified to be current, no response from manufacturer. Information identical to that published in MIL-HDBK-57, Revision B.

Continued

B & B SPECIALTIES INC
 4321 E. LAPLMA AVE.
 ANAHIEM, CA 92807

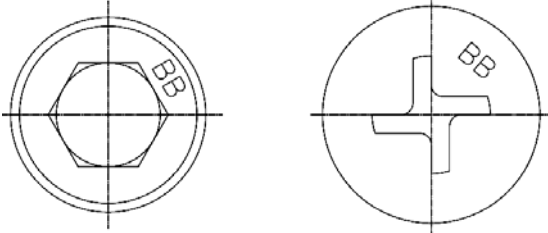

Raised BB is for new manufactured parts.
 Depressed BB is for old stock.

CAGE code: 62206 1/

B & D THREADED ROLLING
 36820 VAN BORN ROAD
 P.O. BOX 275
 WAYNE, MI 48184

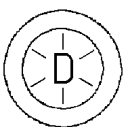

CAGE code: 00LR8 1/

B & E MACHINE SHOP & SHEET METAL FAB., INC.
 3059 SE MONROE ST.
 STUART, FL 34997



CAGE code: 8W179 2/

B & E MANUFACTURING CO., INC.
 7562 ORANGEWOOD AVE.
 STANTON, CA 90680-3498



CAGE code: 59680 1/

B & G MANUFACTURING CO., INC.
 3067 UNIONVILLE PIKE
 P.O. BOX 269
 HATFIELD, PA 19440-1822

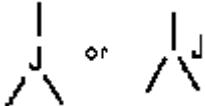

Grade 5

JB7 Grade B7
JB16 Grade B16
JNC Alloy 400

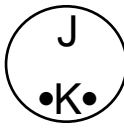

Alloy 500

J4 Grade 4
J2H Grade 2H

CAGE code: 84272 2/

B & N TOOL CO., INC.
 44 ROCKWELL RD.
 NEWINGTON, CT 06111



CAGE code: 0CMJO 2/

B & R MACHINE AND TOOL CORP
 717 MAIN STREET
 WESTBURY, NY 11590



CAGE code: 66936 1/

1/ Information published in this revision was verified by direct contact with manufacturers.

2/ Information not verified to be current, no response from manufacturer. Information identical to that published in MIL-HDBK-57, Revision B.

B F GOODRICH CO. RIVNUT ENGINEERED
FATSEENERS, THE
AEROSPACE AND DEFENSE DIVISION
250 NORTH CLEVELAND-MASSILLION RD.
AKRON, OH 44313

Plant
150 SPRINGSIDE DRIVE
AKRON, OH 44313-0501

BFG+

CAGE code: 2/

B G ENGINEERING, INC.
205 ARENA STREET
EL SEGUNDA, CA 90245

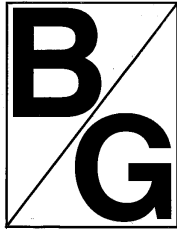

CAGE code: 0WL62 2/

B G M FASTENER CO., INC.
RR 5 BOX 1675
759 OLD WILLOW AVENUE
HONESDALE, PA 18431



CAGE code: 3Y498 1/

B. V. FABRIEK VAN KLINKNAGELS EN
SCHROEFBOUTEN V/H SMIT
2980 GB RIDDERKIRK
P.O. BOX 4075
THE NETHERLANDS



JS

CAGE code: 2/

BARCO ENGINEERING COMPANY, INC.
505 W MAIN ST
TILTON, NH 03276



CAGE code: 29214 2/

BARNEGAT BAY NSCC, INC.
DBA BB NSCC, INC.
6432 DEVONSHIRE DR.
FORT WORTH, TX 76180



CAGE code: 1SDGE 1/

BARRE PRECISION PRODUCTS INC.
199 HOPRIVER ROAD RTE. 6
BOLTON, CT 06043-7443



CAGE code: 7R902 1/

1/ Information published in this revision was verified by direct contact with manufacturers.

2/ Information not verified to be current, no response from manufacturer. Information identical to that published in MIL-HDBK-57, Revision B.

BAS AEROSPACE LIMITED
 2 CRAMPTONS ROAD
 SEVENOAKS, KENT N14 5EF
 UNITED KINGDOM



CAGE code: KCWE1 1/

BAUER & SCHAURTE KARCHER GMBH
 FURTHER STRASSE 24-26
 POSTFACH 10 01 55
 D-4040 NEUSS 1
 FEDERAL REPUBLIC OF GERMANY



INBUS[®]

VERBUS[®] KARRO[®]

CAGE code: D2370 2/

BBC FASTENERS, INC.
 4210 SHIRLEY LANE
 ALSIP, IL 60658

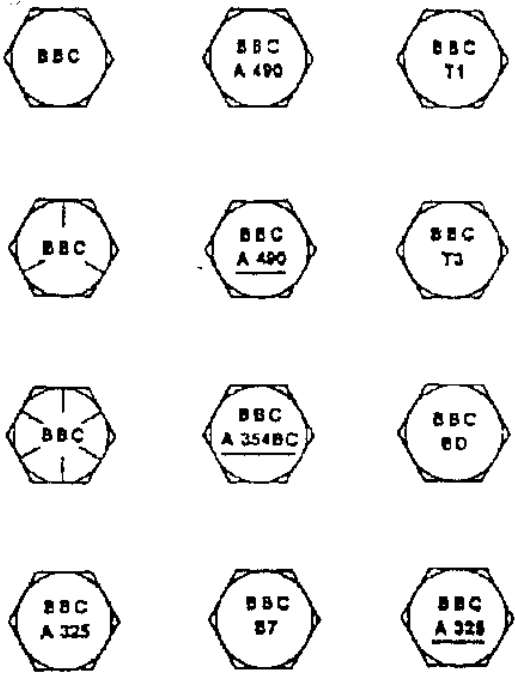

BBC

CAGE code: 2/

BEACH MACHINE
 819 WALKER LN
 NEW MARKET, AL 35761





CAGE code: 0TCDO 2/

1/ Information published in this revision was verified by direct contact with manufacturers.

2/ Information not verified to be current, no response from manufacturer. Information identical to that published in MIL-HDBK-57, Revision B.

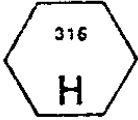
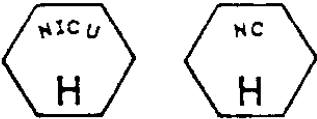
<p>BEAVER PRODUCTS CORP. P.O. BOX 17279 ANAHIEM, CA 92817</p> <p style="text-align: center;">B.P.C.</p> <p>CAGE code: 4P584 <u>2/</u></p>
<p>BEC MACHINE PRODUCTS COMPANY 171 RUTH ROAD HARLEYSVILLE, PA 92806</p> <p style="text-align: center;">BEC</p> <p>CAGE code: 0JC12 <u>2/</u></p>
<p>BEE INDUSTRIES, INC. (WISCONSIN CORPORATION) W6331 BEE ROAD WATERTOWN, WI 53098</p> <p style="text-align: center;">BI</p> <p>CAGE code: 7V765 <u>2/</u></p>
<p>BEGONIA TOOL COMPANY 53 MADISON RD HERMINIE, PA 15637</p> <p style="text-align: center;">BT</p> <p>CAGE code: OL3V3 <u>2/</u></p>

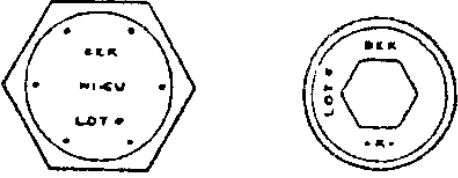
<p>BEK LEVEL 1 FASTENERS 300 THIRD AVE HUNTINGTON, WV 25701</p> <p style="text-align: center;"></p> <p style="text-align: center;">300 Series Stainless Steel</p>
<p style="text-align: center;"></p> <p style="text-align: center;">Type 316 Stainless Steel</p>
<p style="text-align: center;"></p> <p style="text-align: center;">Nickel Copper (Monel)</p>
<p style="text-align: center;"></p> <p style="text-align: center;">Silicon Bronze</p>
<p>BEK LEVEL 1 FASTENERS 721 EAST COMPTON BOULEVARD COMPTON, CA 90220</p> <p style="text-align: center;"></p> <p style="text-align: center;">BEK</p>
<p>CAGE code: <u>2/</u></p>

^{1/} Information published in this revision was verified by direct contact with manufacturers.
^{2/} Information not verified to be current, no response from manufacturer. Information identical to that published in MIL-HDBK-57, Revision B.

BELL FASTENERS (ALBANY
FASTENERS/PAWTUCKET FASTENER
DIVISION)
327 PINE STREET
PAWTUCKET, RI 02862

S **B**
STILLWATER BELL

PMC
PAWTUCKET MANUFACTURING CO.

P **A**
PAWTUCKET ALBANY

SW
ON TOP OF SCREW

••
(two dots) On the top of or bearing surface
of the screw

(SEE VERTEX)

CAGE code: 12360 2/

BELL PRECISION, INC.
131 N. DILLON AVE.
SAN JACINTO, CA 92383

BP

CAGE code: 56122 2/

BELL-MEMPHIS, INC.
1650 CHANNEL AVE
MEMPHIS, TN 38113-01871



CAGE code: 22277 1/

BEN YUAN ENTERPRISE CO, LTD.
NO. 113, CHI-NAN ROAD
TAI-SHIA VILLAGE, KAOHSIUNG HSIEN,
TAIWAN R. O. C.

BY

CAGE code: 2/

BENACO TOOLING RESEARCH & DEV.
CORP.
9287 MERCANTILE DR
MENTOR, OH 44060



CAGE code: 5W644 2/

BEOTOOL CORP.
725 WHITNEY DR
BLUE BELL, PA 19422-1205

BOT

CAGE code: 2N084 2/

1/ Information published in this revision was verified by direct contact with manufacturers.

2/ Information not verified to be current, no response from manufacturer. Information identical to that published in MIL-HDBK-57, Revision B.

BERGNER, RICHARD GMBH & CO.
 BAHNHOFSTRAUSSE 8-16
 P.O. BOX 1180
 SCHWABACH, 91126
 GERMANY



RIBE

Where required and applicable, these fasteners types are also marked with the logo "RIBE" and/or capital "B" with screw in circle.



CAGE code: D2282 2/

BER-LOW MFG INC.
 DBA BUTECH PRESSURE SYSTEMS
 4928 PITTSBURGH AVE
 ERIE, PA 16509



CAGE code: 62295 2/

BERRY, JOHN
 DBA BERRY MANUFACTURING
 5505 BREWSTER ST
 SAN ANTONIO, TX 78233

BM

CAGE code: 65003 1/

BERRY MANUFACTURING
 1090 HWY 72, BOX 336
 GOLDEN, CO 80403

BM

CAGE code: 65003 1/

BETA CORP.
 2332 S DELAWARE ST
 DENVER, CO 80223 - 4321



CAGE code: 06671 2/

BETA ENGINEERING, INC.
 P.O. BOX 80
 468 DODSON LAKE DRIVE
 ARLINGTON, TX 76012-3441



CAGE code: 33436 1/

1/ Information published in this revision was verified by direct contact with manufacturers.

2/ Information not verified to be current, no response from manufacturer. Information identical to that published in MIL-HDBK-57, Revision B.

BIG BOLT CORP.
140 COVINGTON DRIVE
BLOOMINGDALE, IL 60108-3105

BB

BB

BB
•

BB
•

BB
•

CAGE code: 3Q6H0 1/

BISHOP ENTERPRISES, INC.
10 EAST BISHOP ST.
WATERFORD, CT 06385



CAGE code: 6Y882 2/

BLAINE TOOL CORP.
5024 FALL CREEK RD
INDIANAPOLIS, IN 46220-5344



CAGE code: 17027 2/

BLANC AERO INDUSTRIES
see LISI AEROSPACE

BLANC AERO INDUSTRIES
193 R DE BERCY
PARIS, FRANCE 75012

BLANC AERO INDUSTRIES
Saint Chamond Granat
18 20 Rue S-Hilaire
Saint Ouen L'Aumone, France 95310

P (Sr Briec)
B (Paris)
P (Villefranche de
Rouergue)
ds. F

BLANC AERO INDUSTRIES
18,20 RUE ST. HILAIRE
SAINT OUEN L'AUMONE, FRANCE
95310









BLANC AERO INDUSTRIES
DECOLLETAGE MODERNE
5 BIS, PLACE LEON BLUM
75020- PARIS
FRANCE



CAGE code: F0188 2/



1/ Information published in this revision was verified by direct contact with manufacturers.



2/ Information not verified to be current, no response from manufacturer. Information identical to that published in MIL-HDBK-57, Revision B.

<p>BLANC AIRCRAFT FASTENERS, INC. 203020 PRARIE ST P.O. BOX 3819 CHATSWORTH, CA 91842</p> <p style="text-align: center;"> BAF</p> <p>CAGE code: <u>2/</u></p>	<p>BOBCAT MANUFACTURING CO. (PLANT) PECK HILL ROAD JOHNSTON, RI 02919</p> <p style="text-align: center;"> </p> <p>CAGE code: 8H536 <u>2/</u></p>
<p>BLAND CO., THE 55 BROOK ST P. O. BOX 330358 WEST HARTFORD, CT 06133</p> <p style="text-align: center;">BL</p> <p>CAGE code: 02991 <u>1/</u></p>	<p>BOGNER ENGINEERING CO. 705 N. SPRINGFIELD STREET P. O. BOX 510 BERRYVILLE, AR 72616</p> <p style="text-align: center;"></p> <p>CAGE code: 04BV8 <u>2/</u></p>
<p>BLUE SKY INDUSTRIES, INC. 1230 MONTEREY PASS ROAD MONTEREY PARK, CA 91754-3617</p> <p style="text-align: center;"><i>No Logo Listed</i></p> <p>CAGE code: 1BRD5 <u>2/</u></p>	<p>BOLLHOFF & CO. GmbH & CO. KG ARCHIMDESTRASSE 1-4 BIELEFELD, D-4800 14 GERMANY</p> <p style="text-align: center;"></p> <p>CAGE code: <u>2/</u></p>
<p>BLUE TEE CORP DBA GEFCO/ STECO 2215 S. VAN BUREN ST. ENID, OK 73703-8218</p> <p style="text-align: center;"></p> <p>CAGE code: 21363 <u>2/</u></p>	<p>BOLT & NUT CO. PARK LANE EAST TIPTON, WEST MIDLANDS, DY4 8RF GREAT BRITIAN</p> <p style="text-align: center;"></p> <p>CAGE code: <u>2/</u></p>

1/ Information published in this revision was verified by direct contact with manufacturers.

2/ Information not verified to be current, no response from manufacturer. Information identical to that published in MIL-HDBK-57, Revision B.



<p>BOLT FASTENER STUD/TECHNOLOGY 118 W NUGENT ST P.O. BOX 2569 LANCASTER, CA 93535</p> <p>Plant 210 EAST AVENUE LANCASTER, CA 93539</p>  <p>CAGE code: 31386 <u>2/</u></p>
<p>BOLTWORKS, INC. 2150 WOODLAND WARRENDALE, PA 15086-7536</p>  <p>CAGE code: 3LYS4 <u>1/</u></p>
<p>BOMAR ENGINEERING, INC. 13385 PHILLIPPI AVE. SYLMAR, CA 91342</p>  <p>CAGE code: 3U494 <u>2/</u></p>
<p>BOMBSHELL, INC. 9565 PATHWAY ST. #B SANTEE, CA 92071</p> <p style="text-align: center;">509W0</p> <p>CAGE code: 509W0 <u>1/</u></p>

<p>BRACELENTE MANUFACTURING CO., INC. 20 WEST CREAMERY ROAD P.O. BOX 570 TRUMBAUERSVILLE, PA 18970-0570</p> <p style="text-align: center;">BMC INC.</p> <p>CAGE code: 2Y035 <u>1/</u></p>
<p>BRADY MACHINE, INC. 6125 SKY ROAD JOSHUA, TX 76058-4048</p>  <p>CAGE code: 1HLW8 <u>1/</u></p>
<p>BRANCH MACHINE PARTS, INC. 2419 EMPIRE AVE BURBANK, CA 91504</p>  <p>CAGE code: <u>2/</u></p>
<p>BRIARWOOD FASTENERS, INC. 9701 OWENSMOUTH AVE. UNIT 8 CHATSWORTH, CA 91311-4814</p> <p style="text-align: center;">BFI</p> <p>CAGE code: 3N278 <u>1/</u></p>

1/ Information published in this revision was verified by direct contact with manufacturers.

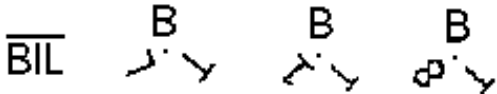
2/ Information not verified to be current, no response from manufacturer. Information identical to that published in MIL-HDBK-57, Revision B.

<p>BRIDEAN MACHINE & TOOL CO., INC. 155 BANGOR STREET LINDENHURST, NY 11757-3632</p> <p style="text-align: center;">  </p> <p>CAGE code: 1S023 <u>1/</u></p>
<p>BRIDGEVIEW MANUFACTURING CO. (ILLINOIS CORPORATION) 7320 S. FERDINAND AVENUE BRIDGEVIEW, IL 60455-1111</p> <p style="text-align: center;">BVB</p> <p>CAGE code: 0ALM2 <u>1/</u></p>
<p>BRIGHT LIGHTS USA, INC. 145 SHREVE AVE. BARRINGTON, NJ 08007</p> <p style="text-align: center;">BL</p> <p>CAGE code: 0RMF7 <u>1/</u></p>
<p>BRINTCLIFFE TURNER LTD. CRAMPTONS ROAD SEVENOAKS, KENT, TN14 5DS GREAT BRITAIN</p> <p style="text-align: center;">  </p> <p>CAGE code: <u>2/</u></p>

<p>BRISTOL INDUSTRIES 630 EAST LAMBERT RD. BREA, CA 92821</p> <p>B+ CAPITAL B FOLLOWED BY PLUS SIGN RAISED OR DEPRESSED</p> <p>BI CAPITAL B FOLLOWED BY CAPITAL I USED FOR EUROPEAN PARTS ONLY RAISED OR DEPRESSED</p> <p>  TWO ADJACENT DOTS RAISED OR DEPRESSED </p> <p style="text-align: center;">  </p> <p style="text-align: center;"> TWO ADJACENT DOTS RAISED OR DEPRESSED </p> <p>B - old callout no longer used on new product</p> <p>CAGE code: 27238 <u>1/</u></p>
--

1/ Information published in this revision was verified by direct contact with manufacturers.

2/ Information not verified to be current, no response from manufacturer. Information identical to that published in MIL-HDBK-57, Revision B.

BRISTOL LOCKNUT CO. (NUT DIVISION)
 32451 N. AVIS DRIVE
 MADISON HEIGHTS, MI 48071



CAGE code: _____ 2/

BROADSTONE TOOL & DIE, INC.
 R #1, BOX 986
 MCARTHUR, OH 45651



CAGE code: 4Z678 2/

BROWN PRODUCTION, INC.
 804 W MEEKER ST.
 KENT, WASHINGTON 98032-5702



CAGE code: 2D069 2/

BRUNNER DRILLING & MFG. CO., INC.
 405 ELROY ST.
 P.O. BOX 137
 ELROY, WI 53929

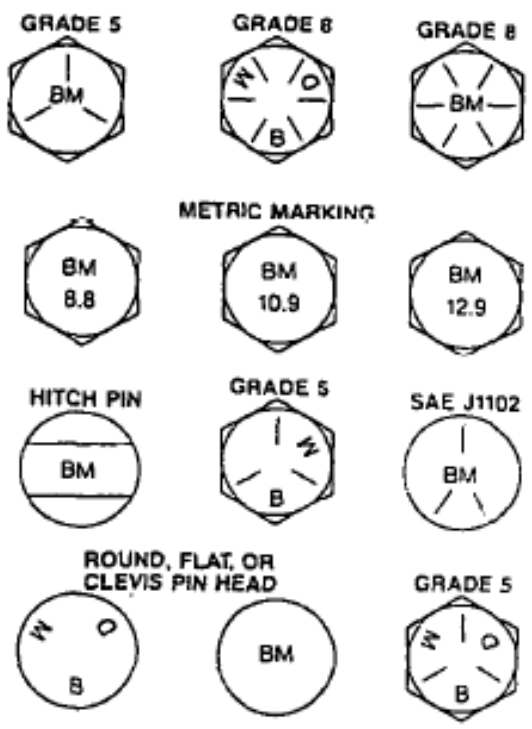

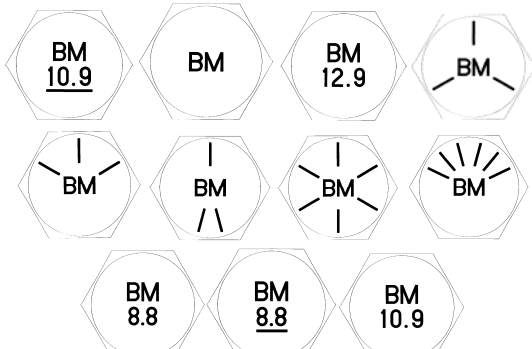

CAGE code: 24407 1/

BRUNNER MANUFACTURING CO.
 DBA BRUNNER MANUFACTURING
 DIVISION
 1025 PARKER DR
 MAUSTON , WI 53948 9381



CAGE code: 3B7H2 1/

1/ Information published in this revision was verified by direct contact with manufacturers.
2/ Information not verified to be current, no response from manufacturer. Information identical to that published in MIL-HDBK-57, Revision B.

<p>BRYCO MACHINE, INC. 7800 GRAPHICS DRIVE TINLEY PARK, IL 60477</p> <p>BM</p> <p>CAGE code: 1WCD4 <u>1/</u></p>
<p>BUCK EYE FORGE, INC. 11700 HARVARD AVE CLEVELAND, OH 44105</p>  <p>CAGE code: 71177 <u>2/</u></p>
<p>BUCKEYE MACHINING, INC. 25020 LAKELAND BLVD. CLEVELAND, OH 44132</p>  <p>CAGE code: 8X808 <u>2/</u></p>

<p>BUFFALO PUMPS, INC. (SUBSIDIARY OF AMPCO-PITTSBURGH CORP.) 874 OLIVER STREET NORTH TONAWANDA, NY 14120-3210</p> <p>BP</p> <p>CAGE code: 83130 <u>2/</u></p>
<p>BULA FORGE INC. 2987 E 87TH ST CLEVELAND, OH 44104-4</p> <p>BULA</p> <p>CAGE code: <u>2/</u></p>

1/ Information published in this revision was verified by direct contact with manufacturers.

2/ Information not verified to be current, no response from manufacturer. Information identical to that published in MIL-HDBK-57, Revision B.

BULTEN TRADING AB
 P.O. BOX 516
 734 01 HALLSTAHAMMAR
 SWEDEN

Bulten Stainless AB
 Ashammar Works
 810 25 Ashammar
 Sweden

Bulten Stainless AB
 Svartå Works
 710 11 Svartå
 Sweden

BH
 BULTEN AB

BUFO
 BULTEN AB

SÅ
 BULTEN STAINLESS AB

CAGE code: N8286 2/

BURROWERS RESEARCH MACHINING,
 INC.
 43 BRADFORD STREET
 P.O. BOX 1130
 CONCORD, MA 01742

BRM

CAGE code: 2/

BUSAN INDUSTRIAL MACHINERY CO.,
 LTD.
BOLT DIVISION
 456-9, NAE-DONG, CHANGWON
 KYEONGSANGNAM-DO, KOREA

BM

BIM

CAGE code: 2/

BUTECH PRESSURE SYSTEMS
 4928 PITTSBURGH AVE
 ERIE, PA 16509

See BER-LOW MFG INC

BPS

CAGE code: 62295 2/

BUTLER, INC.
 1600 WEST 166TH STREET
 GARDENA, CA 90247

JB

CAGE code: 59053 1/

1/ Information published in this revision was verified by direct contact with manufacturers.

2/ Information not verified to be current, no response from manufacturer. Information identical to that published in MIL-HDBK-57, Revision B.

<p>C & D MACHINE TOLL, INC. 726 COURT STREET SPRINGFIELD, OH 45506</p> <p>C&D MACH</p> <p>CAGE code: 064X3 <u>1/</u></p>
<p>C & H MFG., INC. 4280 E LOWELL ST ONTARIO, CA 91761-1529</p> <p>30633</p> <p>CAGE code: 30633 <u>2/</u></p>
<p>C & S ENGINEERING LLC 15401 CARMENITA DR. (N) SANTA FE SPRINGS, CA 90670</p>  <p>CAGE code: 4ZH03 <u>1/</u></p>
<p>C. E. MACHINE CO., INC. 1741 SOUTH LEONINE WICHITA, KS 67209-2813</p> <p>MFR 3L665</p> <p>CAGE code: 3L665 <u>2/</u></p>

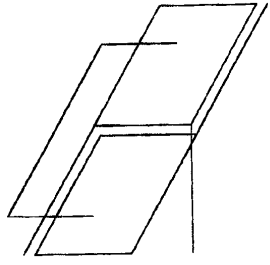
<p>C.E.S. MACHINE PRODUCTS, INC 8880 DOUBLE DIAMOND PKWY RENO, NV 89521-5908</p> <p>CES</p> <p>CAGE code: 1WF66 <u>2/</u></p>
<p>C. J.'S GENERAL MACHINE WORKS 15406 FOREST MIST SAN ANTONIO, TX 78232-4137</p>  <p>CAGE code: 7W334 <u>2/</u></p>
<p>C.R.D. MACHINING 366 W. 131ST ST. LOS ANGELES, CA 90248</p>  <p>CAGE code: 1LA52 <u>2/</u></p>

1/ Information published in this revision was verified by direct contact with manufacturers.

2/ Information not verified to be current, no response from manufacturer. Information identical to that published in MIL-HDBK-57, Revision B.

CALABRESE & SONS, INC.
 406 BRANDY LANE
 P.O. BOX 1667
 MECHANICSBURG, PA 17055-2800



CAGE code: 07310

1/

CALIFORNIA SCREW PRODUCTS CORP.
 P.O. BOX 228
 PARAMOUNT, CA 90723

Plant
 14957 GWENCHRIS AVE.
 PARAMONT, CA 90723-3423

CS

C S

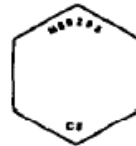

HEX. HEAD



HEX. HEAD

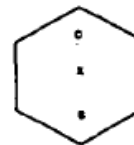

HEX. HEAD

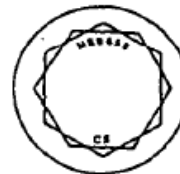

TWELVE POINTS



FLAT HEAD
PAN HEAD
ROUND HEAD
 (ALL TYPES OF HEADS)

CAGE code: 8Z507

1/

1/ Information published in this revision was verified by direct contact with manufacturers.

2/ Information not verified to be current, no response from manufacturer. Information identical to that published in MIL-HDBK-57, Revision B.

CAMBRIDGE SPECIALTY COMPANY, INC.
 DBA POINT MACHINE CO.
 588 FOUR ROD RD
 BERLIN, CT 06037-2280





CAGE code: 9E232 2/

CAMCAR DIVISION OF TEXTRON INC.
 600 18th Ave.
 Rockford, IL 61101

Plant
 AMSCO PRODUCTS
 1818 CHRISTINA ST
 ROCKFORD, IL 24382
 CAGE code: 01536

Head markings

Vendor identification, "A" or four dots raised or depressed located as shown.

Under head markings



Vendor identification, four dots radially located as shown, depressed

CAGE code: 93907 2/

Continued

Continued

CAMCAR DIVISION OF TEXTRON INC.

Plant
 DRILLETITE PRODUCTS
 1304 KERR DR.
 DECORAH, IA 52101
 CAGE code: 0JMM5

Head markings

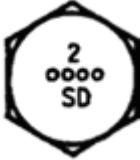
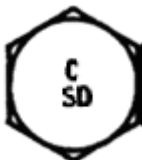

Vendor and customer
 Identification for stainless
 steel, drilled screws,
 raised or depressed

Vendor/Product
 Identification, raised or
 depressed
 Identifies "CAMCAR Self –
 Drilling Fastener."

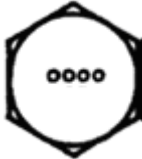

Vendor Identification,
 Four in-line dots, raised or
 depressed

Under head markings

Vendor identification, four radial dots or three equally
 spaced radial lines, depressed

CAGE code: 93907 2/

Continued

1/ Information published in this revision was verified by direct contact with manufacturers.

2/ Information not verified to be current, no response from manufacturer. Information identical to that published in MIL-HDBK-57, Revision B.

38

Source: <http://assist.dla.mil> -- Downloaded: 2024-11-27T23:23Z
 Check the source to verify that this is the current version before use.

Continued

CAMCAR DIVISION OF TEXTRON INC.

Plant
RAYCARL PRODUCTS
 600 18th Ave.
 Rockford, IL 61101
 CAGE code: 6P253

Head markings



Vendor Identification, "CAMCAR" or four in-line dots, raised or depressed.

Under head markings

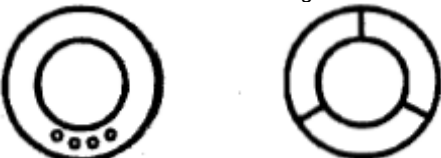

Vendor identification, four radial dots or three equally spaced radial lines, depressed

Plant
ROCKFORD HEADED PRODUCTS
 29201 TELEGRAPH RD. SUITE 611
 SOUTHFIELD, IL 48034-1331

Head markings



Product Identification, "HP" raised or depressed Product Identification, Four in-line dots, raised or depressed

Under head markings

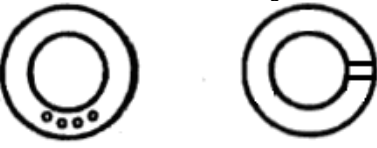

Vendor identification, four radial dots or two parallel lines, raised or depressed

CAGE code: 6P253 2/

Continued

Continued

CAMCAR DIVISION OF TEXTRON INC.

Plant
SEMS PRODUCTS
 1818 CHRISTINA ST
 ROCKFORD, IL 61104
 CAGE code: 01536

Head markings

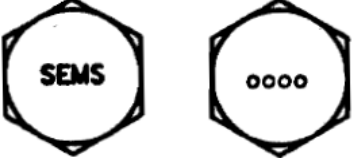

Vendor Identification, "SEMS" or four in-line dots, raised or depressed, located as shown.

Product Trademark Markings



INTERNAL TORX ® RECESS "TORX" and two dots raised or depressed, located as shown



EXTERNAL TORX ® RECESS "TORX" equally spaced on top of washer, raised or depressed.



TORXSTEM ® "TORX" equally spaced on END, raised or depressed.

Plant
SOCKET SCREW PRODUCTS
 1302 KERR DRIVE
 DECORAH, IA 52101
 CAGE code: 0JMM5

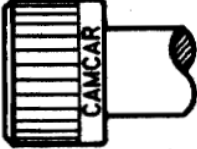
Letters "TORX" plus two dots raised or indented on recess countersink; locate as illustrated (Product Trademark)

Optional Identification, "CAMCAR", raised or indented as illustrated

Vendor Identification, Four radial dots raised or indented, located as shown

Continued 2/

1/ Information published in this revision was verified by direct contact with manufacturers.



2/ Information not verified to be current, no response from manufacturer. Information identical to that published in MIL-HDBK-57, Revision B.

Continued

CAMCAR DIVISION OF TEXTRON INC.



Plant
TAPTITE PRODUCTS
826 EAST MADISON ST
BELVIDERE, IL 61008

Head markings

Product Identification, "TTL" raised or depressed

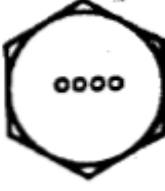

Vendor Identification, "CTY" and three radial lines, raised or depressed

Vendor Identification, Four in-line dots raised or depressed

Vendor Identification, three radial lines and circle, raised or depressed

Under head markings

Vendor identification, four radial dots or three equally spaced radial lines, depressed

Continued 2/

Continued



CAMCAR DIVISION OF TEXTRON INC.

Plant
TORX PRODUCTS
P.O. Box 607
Rochester, IN 46975
CAGE code: 6N040

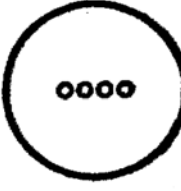
Head markings





Product Identification, "STRUX ®" equally spaced raised or depressed or four in-line dots, raised or depressed.

Vendor Identification, superimposed "T" and "M" raised or depressed

Product Identification "f" and "t" located as shown, raised or depressed





Product Identification, TORX logo located as shown, raised or depressed.

Under head markings



Vendor Identification, four equally spaced radial lines, raised or depressed

Nut Markings

Product Identification, "STRUX ®" raised or depressed, located as shown or four radial dots, raised or depressed.

Continued 2/

1/ Information published in this revision was verified by direct contact with manufacturers.

2/ Information not verified to be current, no response from manufacturer. Information identical to that published in MIL-HDBK-57, Revision B.

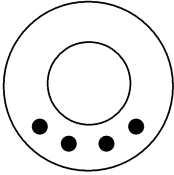

CAMCAR LLC
500 18TH AVENUE
ROCKFORD, IL 61104

CAMCAR

CAGE code: 4WL75 1/



CAMCAR SCREW AND MFG CO DIV OF
TEXTRON INC
29201 TELEGRAPH RD., SUITE 611
SOUTHFIELD, IL 48034 - 7649

HEAD MARKINGS

PRODUCT IDENTIFICATION, 'HP' RAISED OR DEPRESSED.

PRODUCT IDENTIFICATION, FOUR IN-LINE DOTS RAISED OR DEPRESSED.

UNDER HEAD MARKINGS

VENDOR IDENTIFICATION, FOUR RADIAL DOTS RAISED OR DEPRESSED.

VENDOR IDENTIFICATION, TWO PARALLEL LINES RAISED OR DEPRESSED.

CAGE code: 6P253 2/

CAMLOC PRODUCTS
AFS TORRANCE OPERATIONS
3014 WEST LOMITA BLVD.
TORRANCE, CA 90505-5103
CAGE code: 71286

AFS KELKHEIM OPERATIONS
INDUSTRIESTRASSE 6
D-65779 KELKHEIM, GERMANY
CAGE code: D0680

(Corporate office see ALCOA FASTENING SYSTEMS)



CAMLOC



CAGE code: 71286, D0680 1/

CAM-TECH INDUSTRIES
95 ESTATES DR W
FAIRPORT, NY 14450-8425



CAM-TECH
INDUSTRIES, INCORPORATED

CAGE code: 0GT70 2/

CANADY MANUFACTURING CO. INC.
500 FIFTH STREET
SAN FERNANDO, CA 91340-2225



CAGE code: 00678 2/

1/ Information published in this revision was verified by direct contact with manufacturers.

2/ Information not verified to be current, no response from manufacturer. Information identical to that published in MIL-HDBK-57, Revision B.

CAPRICE ENGINEERING CO., INC.
509 HINDRY AVE.
INGLEWOOD, CA 90301-2017



CAGE code: 52916 1/

CAPY MACHINE SHOP, INC.
114 SPAGNOLI ROAD
MELVILLE, NY 11747



CAGE code: 0BVP9 1/

CARDINAL FASTENER & SPECIALTY CO., INC.
5185 RICHMOND RD
BEDFORD HEIGHTS, OH 44146-1330



CAGE code: 2Y089 2/

CARDINAL INDUSTRIAL PRODUCTS
3873 WEST OQUENDO
LAS VEGAS, NV 89118-3010



A capital "C" to be applied to all standard ASME/ASTM bolting material.

MULTI-C

The word "MULTI" followed by a capital "C" to be applied to all ASME bolts manufactured to Nuclear Standards Associates or Cardinal Industrial Products, Inc. Standards.

CAGE code: 57454 2/

CARR CO.
(THE UNITED CARR DIV OF TRW)
31 AMES ST.
CAMBRIDGE, MA 02142



CAGE code: 78947 2/



CATALINA INSTRUMENT CORPORATION
44 SOUTH MALL
PLAINVIEW, NY 11803-4208



CAGE code: 30225 1/

1/ Information published in this revision was verified by direct contact with manufacturers.



2/ Information not verified to be current, no response from manufacturer. Information identical to that published in MIL-HDBK-57, Revision B.

<p>CBS FASTENERS INC. 1345 BRASHER STREET ANAHIEM, CA 92807-2046</p> <p style="text-align: center;">CBS CbS</p> <p>CAGE code: 0F620 <u>1/</u></p>	<p>CELTECH ENTERPRISE 9774 CRESENT CTR DR SUITE 506 RANCHO CUCAMONGA, CA 91730-5745</p> <p style="text-align: center;"></p> <p>CAGE code: 0EFF7 <u>2/</u></p>
<p>CCB INDUSTRIES, INC. 3200 STUART DRIVE P.O. BOX 1158 FT. WORTH, TX 76101</p> <p style="text-align: center;">CCB</p> <p>CAGE code: 60763 <u>1/</u></p>	<p>CENTERLINE TOOL & ENGINEERING, INC. 3107 29TH AVENUE E BRADENTON, FL 34208-7420</p> <p style="text-align: center;"></p> <p style="text-align: center;">Capital "C" and Capital "L" combined.</p> <p>CAGE code: 0B5B0 <u>2/</u></p>
<p>CCF ENTERPRISES INC. 2449 N.W. DALLAS STREET GRAND PRARIE, TX 75050-4971</p> <p style="text-align: center;">CCF</p> <p>CAGE code: 08QQ4 <u>2/</u></p>	<p>CENTRAL OZARK MACHINE, INC. HWY 19 SOUTH & HH P. O. BOX 347 ALTON, MO 65606-0347</p> <p style="text-align: center;"></p> <p>CAGE code: 64896 <u>2/</u></p>
<p>CEI INC. DBA COMMAND ENTERPRISES 700 NORTH DELSEA DR PITMAN, NJ 08071-1244</p> <p style="text-align: center;">L-S-A</p> <p>CAGE code: 6U479 <u>2/</u></p>	

1/ Information published in this revision was verified by direct contact with manufacturers.





2/ Information not verified to be current, no response from manufacturer. Information identical to that published in MIL-HDBK-57, Revision B.

<p>CENTRAL SCREW PRODUCTS 6425 EAST HILDALE DETROIT, MI 48234</p>  <p>CAGE code: 1YCR3 <u>1/</u></p>
<p>CENTURY METAL PARTS CORP. 230 SOUTH FEHRWAY BAY SHORE, NY 11706-1208</p>  <p>CAGE code: 30396 <u>1/</u></p>
<p>CER-MAC INC. 971 HORSHAM RD, HORSHAM, PA 19044-1225</p>  <p>CAGE code: 53569 <u>2/</u></p>
<p>CERNY MFG. CO. 4057 WEST 147TH STREET LAWNDALE, CA 60260</p>  <p>CMC ◊ 22384.</p> <p>CAGE code: 22384 <u>2/</u></p>

<p>CHAMPION COMMERCIAL INDUSTRIES, INC CHAMPION RIVET DIVISION P.O. BOX 398 5137 INDIANAPOLIS BLVD EAST CHICAGO, IN 46312-0398</p> <p style="text-align: center;">V <i>Rivets only</i></p> <p>CAGE code: 4B951 <u>2/</u></p>
<p>CHAMPION FASTENERS, INC. 707 SMITHVILLE RD LUMBERTON, NJ 08048-5302</p>  <p>CAGE code: 0NXPO <u>1/</u></p>
<p>CHANCE, A.B. COMPANY 2201 LAKEVIEW RD MEXICO, MO 65265-1360</p>  <p>CAGE code: 02TP8 <u>2/</u></p>
<p>CHANDLER PRODUCTS, INC. 1491 CHARDON RD CLEVELAND, OH 44117-1598</p>  <p>CAGE code: 83386 <u>1/</u></p>

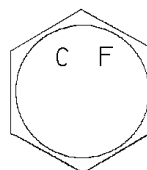

1/ Information published in this revision was verified by direct contact with manufacturers.

2/ Information not verified to be current, no response from manufacturer. Information identical to that published in MIL-HDBK-57, Revision B.

<p>CHATHAM PRECISION, INC. COMMERCE ST. P.O. BOX 510 HINESBURG, VT 05461</p> <p style="text-align: center;">4 N 1 3 3</p> <p>CAGE code: 4N133 <u>2/</u></p>	<p>CHICAGO HARDWARE & FIXTURE CO. 9100 PARK LANE FRANKLIN PARK, IL 60131-3054</p> <p style="text-align: center;">CHF</p> <p>CAGE code: 71747 <u>1/</u></p>
<p>CHEREK MACHINE & TOOL CO., INC. 835 SHERMAN AVENUE HAMDEN, CT 06514-1149</p> <p style="text-align: center;">CHEREK</p> <p>CAGE code: 0YWD4 <u>2/</u></p>	<p>CHIEF MFG. 423B WEST FORK DRIVE ARLINGTON, TX 76012-3450</p> <p style="text-align: center;"></p> <p>CAGE code: 00WU0 <u>1/</u></p>
<p>CHEROKEE TOOL & ENGINEERING CO., INC. P.O. BOX 227 CANTON, GA 30114</p> <p style="text-align: center;"></p> <p>CAGE code: 30662 <u>2/</u></p>	<p>CHOICE PRECISION MACHINE, INC. 4280 COMMERCE DRIVE WHITEHALL, PA 18052</p> <p style="text-align: center;">CPM</p> <p>CAGE code: 1WAA0 <u>2/</u></p>
<p>CHICAGO FASTENER MANUFACTURING 10902 WALNUT LANE MOKENA, IL 60448-8165</p> <p style="text-align: center;"></p> <p>CAGE code: 05TL5 <u>1/</u></p>	<p>CHRIS MACHINE CO. 110 DOYLE ST. DOYLESTOWN, PA 18901-1370</p> <p style="text-align: center;"></p> <p>CAGE code: 2T317 <u>2/</u></p>



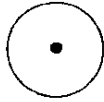

1/ Information published in this revision was verified by direct contact with manufacturers.

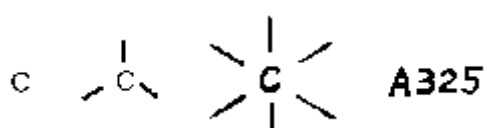

2/ Information not verified to be current, no response from manufacturer. Information identical to that published in MIL-HDBK-57, Revision B.

<p>CHU HUA INDUSTRIAL CO., LTD. 800 FU SHING RD. LU CHU, KAOHSING, TAIWAN, 821 R.O.C.</p>  <p style="text-align: right;">UH</p> <p>CAGE code: <u>2/</u></p>	<p>CLEVELAND HARDWARE & FORGING DBA GREEN BAY DROP FORGE CO 1341 S. STATE ST P.O. BOX 11797 GREEN BAY, WI 54307-1797</p>  <p style="text-align: right;">Circle with center dot</p> <p>CAGE code: 08277 <u>2/</u></p>
<p>CHUN YU WORKS & CO., LTD. 1 CIASHING KANGSHAN, TAIWAN</p> <p style="text-align: center;">L</p> <p>CAGE code: <u>2/</u></p>	<p>CLICK BOND, INC. 2151 LOCKHEED WAY CARSON CITY, NV 89706-0713</p> <p style="text-align: center;">CB</p> <p>CAGE code: 66530 <u>1/</u></p>
<p>CINCH MANUFACTURING 2610 S YALE ST SANTA ANA, CA 92704</p>  <p>CAGE code: <u>2/</u></p>	<p>CLYDE FASTENERS LIMITED 5 HAWBANK RD, EAST KILBRIDE, GLASGOW, SCOTLAND G74 5ET</p> <p style="text-align: center;">CFL</p> <p>CAGE code: <u>1/</u></p>
<p>CINCH-MONADNOCK 18301 ARENTH AVE CITY OF INDUSTRY, CA 91749</p>  <p style="text-align: right;">= (dot)</p> <p>CAGE code: <u>2/</u></p>	<p>CM MANUFACTURING, INC. 6333 BUTLER CREEK ROAD MISSOULA, MT 59808-8861</p> <p style="text-align: center;">CM</p> <p>CAGE code: 6Z056 <u>1/</u></p>

^{1/} Information published in this revision was verified by direct contact with manufacturers.

^{2/} Information not verified to be current, no response from manufacturer. Information identical to that published in MIL-HDBK-57, Revision B.

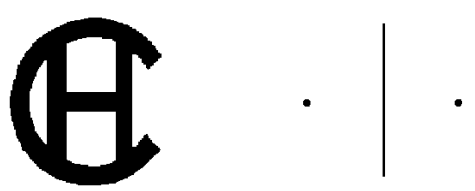

<p>CNC MACHINING INC. 109 PANE ROAD NEWINGTON CT 06111-1552</p> <p style="text-align: center;">C</p> <p>CAGE code: 2Y832 <u>2/</u></p>
<p>COAE BOLTS WORKS CO., LTD NO. 47 CHINAN ROAD, TASHE HSIANG KOAHSIUNG HSIEN, TAIWAN</p> <p style="text-align: center;">  </p> <p>CAGE code: <u>2/</u></p>
<p>COAST INDUSTRIAL SUPPLY CO., INC. SUB OF SPANDCO INDUSTRIES INC. 15959 PIUMA AVENUE CERRITOS, CA 90701-1526</p> <p>  On head of silicon bronze and aluminum hex head cap screws </p> <p>  On head of stainless steel, monel, brass, naval bronze, chrome alloy, hex head cap screws, and the end of alloy steel studs. </p> <p>CAGE code: 9U032 <u>2/</u></p>
<p>CODLING TOOL & MFG. INC. 665 NE 42ND STREET FORT LAUDERDALE, FL 33334</p> <p style="text-align: center;">  </p> <p>CAGE code: 0P3X2 <u>2/</u></p>

<p>COLD HEADING CO., THE 21777 HOOVER RD. WARREN, MI 48089-2544</p> <p style="text-align: center;">  </p> <p>CAGE code: 89657 <u>1/</u></p>
<p>COLOC MANUFACTURING DIVISION INGRAM INDUSTRIES, INC. P.O. BOX 249 CANTON, TX 75103</p> <p style="text-align: center;">  </p> <p>CAGE code: 0M6Y0 <u>1/</u></p> <p style="text-align: center;"> Plant 465 VZ CR 2516 CANTON, TX 75103 </p>
<p>COMET MFG. CO., INC. 315 JOHN DOWNEY DRIVE NEW BRITIAN, CT 06051</p> <p style="text-align: center; font-size: 2em;">61062</p> <p>CAGE code: 61062 <u>2/</u></p>
<p>COMMAND ENTERPRISES 700 NORTH DELSEA DR. PITMAN, NJ 08071 (see CEI, INC.)</p> <p style="text-align: center; font-size: 2em;">C. E. I</p> <p>CAGE code: <u>2/</u></p>

1/ Information published in this revision was verified by direct contact with manufacturers.

2/ Information not verified to be current, no response from manufacturer. Information identical to that published in MIL-HDBK-57, Revision B.

<p>COMPUTA-BASE MACHINING, INC. 411 NORTH GROVE ST P.O. BOX 340 BERLIN, NJ 08009-9704</p> <p style="text-align: center;">CBM</p> <p>CAGE code: 0A396 <u>2/</u></p>
<p>CONNECTICUT AIRCRAFT PRODUCTS 246 SHAKER ROAD ENFIELD, CT 06082-2366</p> <p style="text-align: center;">AP</p> <p>CAGE code: 0KA73 <u>2/</u></p>
<p>CONQUEST MACHINE, INC. 3655 RESEARCH DR. GENESIS A STE 106 LAS CURCES, NM 88003-1239</p> <p style="text-align: center;">CMI</p> <p>CAGE code: 0PNX2 <u>2/</u></p>
<p>CO-OP SCREW MANUFACTURING CORP. 60 SINDLE AVE. LITTLE FALLS, NJ 07424-1649</p> <p style="text-align: center;">C</p> <p>CAGE code: 1FZ52 <u>2/</u></p>
<p>COOPER POWER SYSTEMS INC (MCGRAW EDISON POWER SYSTEMS) NORTH BURSON STREET EAST STROUDSBURG, PA 18301</p> <p style="text-align: center;">M</p> <p>CAGE code: 88424 <u>2/</u></p>

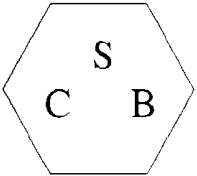
<p>COPELAND MFG. CORP. (JAMES DIVISION) 11222 E. PINE ST. TULSA, OK 74116-1613</p> <p style="text-align: center;"></p> <p style="text-align: center;"></p> <p>CAGE code: 0CM67 <u>2/</u></p>
<p>COPPER STATE BOLT & NUT CO. 3602 N 35TH AVE. 3637 N 34TH AVE. PHOENIX, AZ 85017-4408</p> <p style="text-align: center;"></p> <p>CAGE code: 0Z0Y2 <u>2/</u></p>
<p>CORPUS CHRISTI GASKET & FASTENER LTD. 341 WEST CHESTER RD. P.O. BOX 4074 CORPUS CHRISTI, TX 78408</p> <p style="text-align: center;">CCG</p> <p>CAGE code: 008R2 <u>1/</u></p>

1/ Information published in this revision was verified by direct contact with manufacturers.
2/ Information not verified to be current, no response from manufacturer. Information identical to that published in MIL-HDBK-57, Revision B.

CREATIVE PRECISION INC.
 DBA CREATIVE PRECISION WEST
 2640 E. ROSE GARDEN LANE SUITE 6
 PHOENIX, AZ 85050-4612

Plant
 1501 BLUEBALL AVENUE
 LINWOOD, PA 19061
 CAGE code: 0F3N2

CPI

CAGE code: 1K0E5 1/

CRESENT MANUFACTURING CO.
 P.O. BOX 1350
 BUILINGTON, CT 06013-0350

Plant
 700 GEORGE WASHINGTON TPKE
 BUILINGTON, CT 06013-0350

CMA

CAGE code: 63020 1/

CRS PRECISION CORP.
 640 WEST MERRICK ROAD
 VALLEY STREAM, NY 11580-0482

CRS
 PRECISION CORP.

CAGE code: 07QQ6 2/

CRYSTAL METAL PRODUCTS COMPANY,
 INC.
 2700 E. CASTOR AVENUE
 PHILADELPHIA, PA 191345

CMP

CAGE code: 0BPW8 2/

CSM FASTENER PRODUCTS
 1133 BRTN MAWR AVE.
 BENSENVILLE, IL 60106

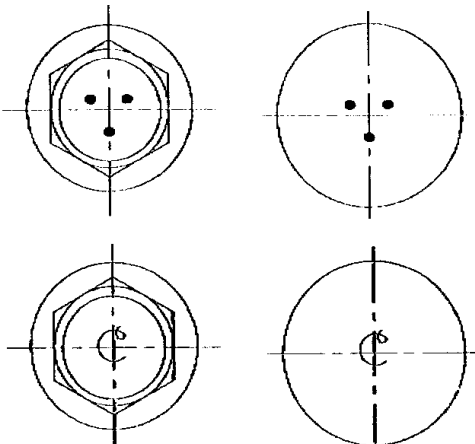

CAGE code: 1CJW4 1/



CURTIS PRESTON ENTERPRISES INC.
 DBA ATLAS SPECIALTY PRODUCTS
 2299 E WINSTON RD
 ANAHEIM, CA 92806-5538

ASP

CAGE code: 0TP31 1/

1/ Information published in this revision was verified by direct contact with manufacturers.

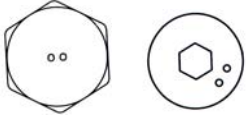
2/ Information not verified to be current, no response from manufacturer. Information identical to that published in MIL-HDBK-57, Revision B.

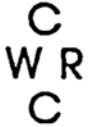
<p>CUTTING EDGE ENTERPRISE, LLC 2465 POLE LINE RD. DECORAH, IOWA 52101</p> <p>Plant 2509 172ND AVE. DECORAH, IOWA 52101</p>  <p>CAGE code: 52101 <u>1/</u></p>	<p>D & D TOOL COMPANY, INC. LEWIS STREET & MAPLE AVENUE EATONTOWN, NJ 07724</p> <p style="text-align: center;">D & D</p> <p>CAGE code: 30077 <u>2/</u></p>
<p>CUTTING EDGE MACHINING INC. NEVADA DIV 1625 LINDA WAY SPARKS, NV 89431</p> <p>See WESTERN SCREW MACHINE PRODUCTS, INC.</p>  <p>CAGE code: 0ZV72 <u>2/</u></p>	<p>D & R MACHINE COMPANY 2310 BIG OAK ROAD LANGHORNE, PA 19047-1910</p> <p style="text-align: center;">4T853</p> <p>CAGE code: 4T853 <u>2/</u></p>
<p>CWR MANUFACTURING CO (DIVISION OF A.J. MUPHY CO., INC.) P.O. BOX 2669 SYRACUSE, NY 13220</p>  <p>CAGE code: <u>2/</u></p>	<p>D. C. MACHINING INC. 1900 9TH AVE., SW WATERTOWN, SD 57201</p> <p style="text-align: center;">DC</p> <p>CAGE code: 0AUC7 <u>2/</u></p>
<p>D & D MACHINERY AND SALES 2420 W. R. LARSON ROAD SAN ANTONIO, TX 78261-2200</p> <p style="text-align: center;">1Y128</p> <p>CAGE code: 1Y128 <u>2/</u></p>	<p>D.S.O. PLASTICS, INC. 1220 ROCK ST. ROCKFORD, IL 61101</p> <p style="text-align: center;">Z</p> <p>CAGE code: <u>2/</u></p>

1/ Information published in this revision was verified by direct contact with manufacturers.

2/ Information not verified to be current, no response from manufacturer. Information identical to that published in MIL-HDBK-57, Revision B.

DACK INDUSTRIES, INC.
 P.O. BOX 427
 FARMINGTON, CT 06034 - 0427

d

CAGE code: 0CZ42 2/

DANIEL CO., EDWARD W.
 11700 HARVARD AVENUE
 CLEVELAND, OH 441053



CAGE code: 73634 2/

DAN-LOC BOLT & GASKET INC.
 FORMALLY
DANIEL INDUSTRIES, INC.
 Bolt & Gasket Division
 P.O. BOX 292
 HOUSTON, TX 77001-0292

Plant
 725 North Drennan
 Houston, TX 77003



STUDS



HEX NUTS

CAGE code: 2/

DARCO PRODUCTS
 8406 WASHINGTON PL NE
 ALBUQUERQUE, NM 87113-1671

D P

CAGE code: 1DL79 2/

DAVE ALLEN ENTERPRISES
 10631 BLOOMFIELD AVENUE
 UNIT 15
 LOS ALAMITOS, CA 90720

DAE

CAGE code: 1NWX4 2/

DAVIES PRECISION MACHINING, INC.
 2400 COLEBROOK RD.
 LEBANON, PA 17042-9562

DPM

CAGE code: 7V760 2/

DAVIS AIRCRAFT PRODUCT CO., INC.
 1150 WALNUT AVENUE
 BOHEMIA, NY 11716-6216



CAGE code: 98313 2/

1/ Information published in this revision was verified by direct contact with manufacturers.

2/ Information not verified to be current, no response from manufacturer. Information identical to that published in MIL-HDBK-57, Revision B.

DECKER MANUFACTURING CORP
 703 NORTH CLARK STREET
 P.O. BOX 410
 ALBION, MI 49224-1455

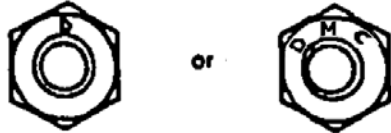

HEX WHEEL NUTS
 (DEPRESSED "D" or "MDC")



AMERICAN STANDARD
 SQUARE, HEX, AND ROUND WELD NUT
 (SMALL RAISED DOR ON CHAMFER)



METRIC
 SQUARE, HEX, AND ROUND WELD NUTS
 (DEPRESSED LETTER "D" AND CLASS NO.)

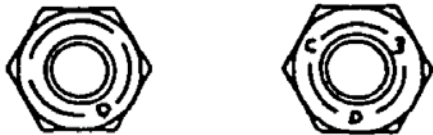

A-563
 STRUCTURAL NUTS
 (DEPRESSED "D" OR "DMC")

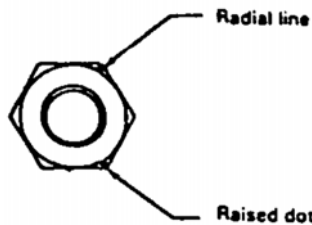

GRADE 5
 HEX NUTS
 (ONE RAISED RADIAL LINE 120°
 COUNTERCLOCKWISE FROM ONE
 RAISED DOT ON CHAMFER)

CAGE code: 12876

2/

DEERE & CO.
 JOHN DEERE PLACE
 MOLINE, IL 61265

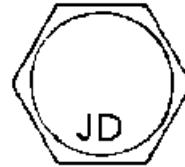

CAGE code: 75160

2/

DEFENSE AEROSPACE
 MFG OF DEFENSE AEROSPACE
 THREADED MACHINE PARTS
 10841 NOEL ST. #104
 LOS ALAMITOS, CA 90720-2527

DAS
1

CAGE code: 1W4A6

1/

DEFENSE QUALITY MFG.
 40 SACCO RD.
 ROYERSFORD, PA 19468-1030





DQ



CAGE code: 0B6M7

2/

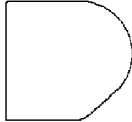
1/ Information published in this revision was verified by direct contact with manufacturers.







2/ Information not verified to be current, no response from manufacturer. Information identical to that published in MIL-HDBK-57, Revision B.

<p>DEFIANCE STAMPING COMPANY, THE P.O. BOX 506 DEFIANCE, OHIO 43512-2743</p> <p>PLANT 1090 PERRY ST DEFIANCE, OHIO 43512-2743</p>  <p>CAGE code: 6B357 <u>2/</u></p>
<p>DEHOUSSE (USINES) 64007 PAU FRANCE</p> <p style="text-align: center;">D</p> <p>CAGE code: BP714 <u>2/</u></p>
<p>DELL MFG. CO., INC. 4 RIGHT LANE FARMINGTON, CT 06032-3195</p>  <p>CAGE code: 5A628 <u>1/</u></p>
<p>DELT INDUSTRIES, INC. (AEROSPACE PRODUCTS DIVISION) 90 WEST EASY STREET, STE 2 P.O. BOX 940067 SIMI VALLEY, CA 93065-6206</p>  <p>CAGE code: 064T2 <u>1/</u></p>

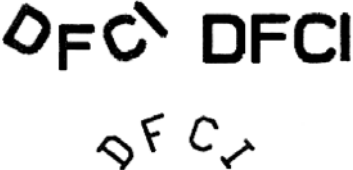
<p>DELTA MACHINE & TOOL CO., INC. PARKMOUNT ROAD P.O. BOX 351 GLEN RIDDLE, PA 19037</p>  <p>CAGE code: <u>2/</u></p>
<p>DEL-VAL FASTENER MANUFACTURING P.O. BOX 2901 21-D INDUSTRIAL DRIVE WARMINSTER, PA 18974</p> <p style="text-align: center;">DV</p> <p>CAGE code: 1EE10 <u>2/</u></p>
<p>DEMAT (CANCELLED AND REPLACED BY ALCOA FASTENER SYSTEMS) BD DU GRAND CASTAING ZI BD DU GRD CASTING ROQUES, FRANCE 31120</p>  <p style="text-align: center;">DT M</p> <p style="text-align: center;">D</p> <p>CAGE code: F7411 <u>2/</u></p>



1/ Information published in this revision was verified by direct contact with manufacturers.

2/ Information not verified to be current, no response from manufacturer. Information identical to that published in MIL-HDBK-57, Revision B.

<p>DEPENDABLE MACHINE CO., INC. 1846 E 30TH ST INDIANAPOLIS, IN 46218-2607</p>  <p>CAGE code: 14554 <u>2/</u></p>	<p>DFCI SOLUTIONS, INC. 425 UNION BLVD. WEST ISLIP, NY 11795-3183</p>  <p>CAGE code: 72794 <u>1/</u></p>
<p>DERBYSHIRE MACHINE & TOOL CO. DBA DERBYSHIRE MARINE PRODUCTS 5100 BELFIELD AVENUE PHILADELPHIA, PA 19144-1788</p>  <p>CAGE code: 71905 <u>1/</u></p>	<p>DHL ENTERPRISES 1260 E. WOODLAND AVENUE #46 P. O. BOX 295 MORTON, PA 19070</p>  <p>CAGE code: 0UGD5 <u>2/</u></p>
<p>DETROIT HEADING CO. 6421 LYNCH RD. DETROIT, MI 48234-4140</p>  <p>CAGE code: 0TUA2 <u>2/</u></p>	<p>DIAL SUPPLY AND MFG., INC. 1315 FM 1187 #106 MANSFIELD, TX 76063</p>  <p>CAGE code: 9N473 <u>1/</u></p>
<p>DEUTSCH COMPANY INC., THE DBA DEUTSCH CO THE METAL COMPONENT 14800 S. FIGUEROA STREET GARDENA, CA 90248-1795</p>  <p>CAGE code: 14798 <u>2/</u></p>	<p>DIESEL PARTS COMPANY OF CALIFORNIA 1900 EAST 12TH STREET OAKLAND, CA 94606-4821</p>  <p>CAGE code: 24378 <u>2/</u></p>

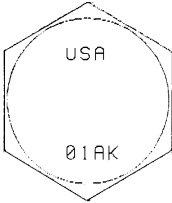

1/ Information published in this revision was verified by direct contact with manufacturers.



2/ Information not verified to be current, no response from manufacturer. Information identical to that published in MIL-HDBK-57, Revision B.

<p>DIHARD COMPANY 3161 MAJOR STREET FORT WORTH, TX 76112 - 7020</p> <p style="text-align: center;">D</p> <p>CAGE code: 0F1U4 <u>2/</u></p>	<p>DO-ALL PRECISION, INC. 9 UNION AVENUE MOUNT VERNON, NY 10550</p>  <p>CAGE code: <u>2/</u></p>
<p>DISC-LOCK INTERNATIONAL 1924 S PACIFIC COAST HWY SUITE F REDONDO BEACH , CA 90277</p> <p style="text-align: center;">DL</p> <p>CAGE code: 72731 <u>2/</u></p>	<p>DOMESTIC FASTENER & FORGE, INC. P.O. BOX 14642 LENEXA, KS 66285</p> <p>Plant 15850 W. 108TH STREET LENEXA, KS 66219</p>  <p>CAGE code: 09ML9 <u>1/</u></p>
<p>DIXON MACHINE & TOOL DBA DIXON MACH AND FABRICATION 6807 CHAPMAN HWY. KNOXVILLE, TN 37920-6560</p> <p>see TROY D. RAY</p> <p style="text-align: center;">DMT</p> <p>CAGE code: 1DEP3 <u>2/</u></p>	<p>DOMESTIC FORGING, INC. P.O. BOX 693 NEW HAVEN, MI 48048</p>  <p>CAGE code: <u>2/</u></p>
<p>DO MANUFACTURING CORP. P.O. BOX 2382 114 BROOKLYN ST ROCKVILLE, CT 06066</p> <p style="text-align: center;"><i>PLANT</i> 114 BROOKLYN ST. ROCKVILLE, CT 06066</p>  <p>CAGE code: 1H312 <u>2/</u></p>	<p>DONSON MACHINE ALSIP MACHING GROUP 12416 S. KEDVALE AVENUE ALSIP, IL 60803-1819</p> <p style="text-align: center;">DMC</p> <p>CAGE code: 0BHD5 <u>1/</u></p>

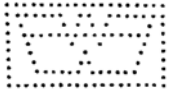
1/ Information published in this revision was verified by direct contact with manufacturers.

2/ Information not verified to be current, no response from manufacturer. Information identical to that published in MIL-HDBK-57, Revision B.

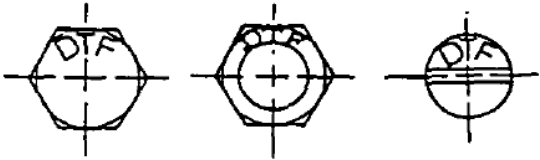
<p>DOUBLECO INCORPORATED DBA R & D FASTENERS 9444 9TH STREET RANCHO CUCAMONGA, CA 91730</p>  <p>CAGE code: 1UKP3 1/</p>
<p>DOUGLASS TOOL & ENGINEERING CO., INC. 304 EAST DYER ROAD SANTA ANA, CA 92707</p> <p style="text-align: center;">DTE Marking to be indented</p> <p>CAGE code: 2/</p>
<p>DRESSER INDUSTRIES, INC. DRESSER PUMP DIVISION 142 CLINTON ROAD FAIRFIELD, NJ 07004</p>  <p>CAGE code: 0LNV2 2/</p>
<p>D'SAMIC 1261 HOBLITT AVE # 206 CLOVIE, CA 93612-2811</p>  <p>CAGE code: 2/</p>

<p>DTF MANUFACTURING, INC. DIV OF FEDERAL SCREW AND SUPPLY CO P. O. BOX 329 146 ALBANY AVE. LINDENHURST, NY 11757</p>  <p style="text-align: center;">Standard: DTF Large Dia: DTF Micro Dia: d</p> <p>CAGE code: 0H802 2/</p>
<p>DUFFY ELECTRONICS & MFG. CO. 50 BARNES PARK RD WALLINGFORD, CT 06492</p>  <p>CAGE code: 2/</p>
<p>DUNCAN ELECTRONICS & MFG. CO. 701 SEVENTH AVE. BELMAR, NJ 07719</p>  <p>CAGE code: 2/</p>

1/ Information published in this revision was verified by direct contact with manufacturers.

2/ Information not verified to be current, no response from manufacturer. Information identical to that published in MIL-HDBK-57, Revision B.

DUNHAM PRODUCTS, INC.
6 INDUSTRIAL DRIVE
BEDFORD, OH 44146-4414

DP

CAGE code: 1B4S0 2/

DUPONT, G.B. CO., INC.
(SEE KAMAX L. P.)
500 WEST LONG LAKE ROAD
TROY, MI 48098-4540

D

CAGE code: 1DWW1 1/

DUSEVOIR METAL PRODUCTS, INC.
1751 S TELEGRAPH RD
P.O. BOX 2158
DEARBORN, MI 41823



CAGE code: 97233 2/

DUVE GmbH & CO. KG
P.O. BOX 1240
NEUENRADE, GERMANY D-5982

D - All hexagon head screws and bolts made of high tensile steel grade 8.8 up to 12.8, and sealing fasteners made of case-hardened carbon steel

DX - Hexagon head sealing fasteners made of stainless steel

DUVEX - Hexagon head screws and bolts made of stainless steel (A2 + A4)

DUVE - DUVE DRIL-KWICK Self-Drilling Fastener (Screws)

DUVE

CAGE code: 2/

DYNACAST
INDUSTRIAL FASTENERS DIVISION
1401 FRONT STREET
YORKTOWN HEIGHTS, NY 10598



CAGE code: 2/



DYNAMIC ENGINEERING
720 11TH AVE., S.E.
P.O. BOX 697
WATERTOWN, SD 57201-0697





CAGE code: 9U252 2/

1/ Information published in this revision was verified by direct contact with manufacturers.



2/ Information not verified to be current, no response from manufacturer. Information identical to that published in MIL-HDBK-57, Revision B.

<p>DYSON CORP THE formerly (JOS. DYSON & SONS, INC.) 53 FREEDOM RD PLAINSVILLE, OH 44077-1232</p>  <p>CAGE code: 22132 2/</p>
<p>DZUS FASTENER CO., INC. see DFCI SOLUTIONS, INC. 425 UNION BLVD WEST ISLIP, NY 11795</p> <p style="text-align: center;">DZUS DZUS</p> <p>CAGE code: 3L478 cancelled- replaced by 72794 2/</p>
<p>E. KOZAK PRECISION PRODUCTS CO. 45 WOODLAND AVE. ROCKAWAY, NJ 07866</p> <p style="text-align: center; font-size: 2em;">KPP</p> <p>CAGE code: ICP43 2/</p>
<p>E.L.R. MACHINE AND TOOL 48 A VINCENT CIRCLE IVYLAND, PA 18974</p>  <p>CAGE code: 2/</p>

<p>EAGAN MACHINE CORP. 135 CENTER STREET BRISTOL, CT 06010</p>  <p>CAGE code: 2/</p>
<p>EAGLE PICHER INDUSTRIES (PRECISION PRODUCTS PLANT) 1927 W 4TH ST P.O. BOX 1444 JOPLIN, MO 64801-3</p>  <p>CAGE code: 9L734 2/</p>
<p>EAGLEHEAD MANUFACTURING COMPANY DBA DEJAK MACHINE TOOL COMPANY DIV DEJAK DRILLING 23555 EUCLID AVE EUCLID, OH 44117-1703</p> <p style="text-align: center;">Alphanumeric Designation</p> <p style="text-align: center; font-size: 1.5em;">01NU</p> <p>CAGE code: 1GVE5 2/</p>
<p>EAST COAST METALS INC. 171 RUTH ROAD HARLEYSVILLE, PA 19438</p> <p style="text-align: center; font-size: 2em;">E</p> <p>CAGE code: 4W058 2/</p>

1/ Information published in this revision was verified by direct contact with manufacturers.

2/ Information not verified to be current, no response from manufacturer. Information identical to that published in MIL-HDBK-57, Revision B.

<p>EASTERN SCREW CO., INC. 15 AMFLEX DRIVE CRANSTON, RI 02921-2028</p> <p>Plant 71 MILL STREET JOHNSON, CRANSTON, RI 02921-2028</p>  <p>CAGE code: 2L684 <u>1/</u></p>
<p>EASTWOOD MFG., CO. P.O. BOX 231102 6825 BREEN RD HOUSTON, TX 77086-3719</p> <p>Plant 52 Lawndale Houston, TX 77023</p>  <p>CAGE code: 77903 <u>2/</u></p>
<p>EATON AEROQUIP CORPORATION (AEROSPACE DIVISION) 300 S. EAST AVE. JACKSON, MICHIGAN 49203-1972</p>  <p>CAGE code: 00624 <u>2/</u></p>
<p>EBC INDUSTRIES (FORMERLY ERIE BOLT CORP.) 1325 LIBERTY STREET ERIE, PA 16502-1641</p>  <p>CAGE code: 5G920 <u>1/</u></p>

<p>EBERHARD BRUNINGHAUS POSTFAUCH 12 06 1M DUDA2 NEUENRADE, FEDERAL REPUBLIC OF GERMANY D 5982</p>   <p>CAGE code: <u>2/</u></p>
<p>ECENARRO S. COOP. LTDA. c/ AMILLAGA, 15. BERGARA - GUIP'UZOCA, SPAIN 20500</p>   <p>CAGE code: <u>2/</u></p>
<p>EDS ORDNANCE 644 C ANCHORS ST. FT. WALTON BEACH, FL 32548</p>  <p>CAGE code: 1CA31 <u>2/</u></p>

1/ Information published in this revision was verified by direct contact with manufacturers.
2/ Information not verified to be current, no response from manufacturer. Information identical to that published in MIL-HDBK-57, Revision B.

ELASTIC STOP NUT
(Division of Harvard Industries, Inc.)

See MACLEAN-ESNA

Plant
2330 Vauxhall Road
Union, NJ 07083

2nd Plant
3200 Country Club Road
P.O. Box 988
Pocahontas, AR 72455

E, EN, or ESNA Red nylon insert in locknuts

Red nylon insert in locknuts identifies Esna as manufacturer

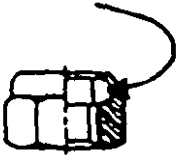

CAGE code: 2/

ELCO INDUSTRIES, INC.
1111 SAMUELSON RD
ROCKFORD, IL 61101

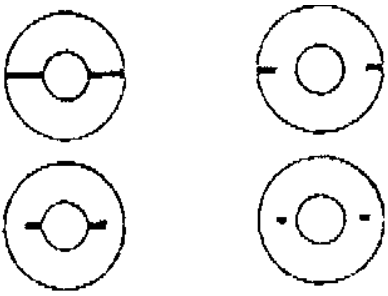

Underside of screw head



CAGE code: 83486 2/

ELECTRO-FREETO MANUFACTURING COMPANY
37 POPE ROAD
HOLLISTON, MA 01746-2218

JF

CAGE code: 17401 2/

ELITE FASTENERS
6400 DALE STREET
BUENA PARK, CA 90621



CAGE code: 0T3D2 2/

ELLIS PRECISION INDUSTRIES
DBA E P IND.
3133 RAMONA DR
FORT WORTH, TX 76116-5122

e



CAGE code: 9Z199 2/

EMERALD VALLEY MFG
3825 W. 11TH AVE
SUITE B
EUGENE, OR 97402

DTE

CAGE code: 4Y352 2/

1/ Information published in this revision was verified by direct contact with manufacturers.

2/ Information not verified to be current, no response from manufacturer. Information identical to that published in MIL-HDBK-57, Revision B.

EMHART CORP.
PARKER-KALON DIVISION
395 ROBERTS ROAD
CAMPBELLSVILLE, KY 42718

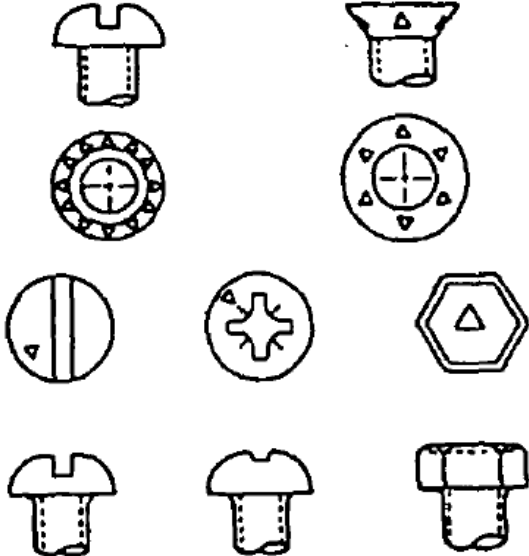

"TRIANGLE" MARKING

EMHART CORP
GRIPCO FASTENER DIVISION
111 EAST BROAD STREET
SOUTH WHITLEY, IN 46787



G_H raised or indented on
flange or bearing surface



G_H raised on head, both
inch and metric series e



G_H raised or indented on
flange or bearing surface

CAGE code: 73020

2/

EMP MANUFACTURING CO.
40935 PRODUCTION DR
HARRISON TOWNSHIP, MI 48045-1351

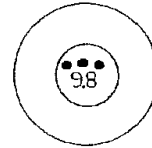

CAGE code: 4G973

2/

EMPIRE PRECISION MACHINING
108 W. HOLLOWAY DR.
HURST, TX 76053-6807



CAGE code: 5V179

1/

ENGEL MANUFACTURING COMPANY,
INC., THE
304 W. EWING AVENUE
SOUTH BEND, IN 46613-2108



CAGE code: 0XYS0

2/

ENGINEERED BOLTING PRODUCTS, INC.
P.O. BOX 7067
301 MONTGOMERY ST
SHREVEPORT, LA 71137

Plant
301 Montgomery St.
Shreveport. LA 71107

EBP

CAGE code: 0K4X1

2/

1/ Information published in this revision was verified by direct contact with manufacturers.

2/ Information not verified to be current, no response from manufacturer. Information identical to that published in MIL-HDBK-57, Revision B.

ENGINEERING MATERIALS CO., INC.
 FASTENER MANUFACTURING DIVISION
 2055 WEST COWLES STREET
 LONG BEACH, CA 90813-1087

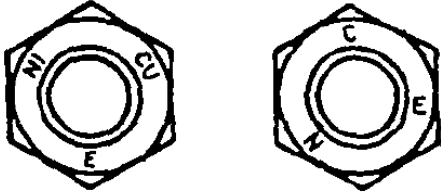

Mfr. Symbol/Logo embossed or intent marked. Letter "E" as shown on nut crown spaced 120 degrees from material symbol marking.

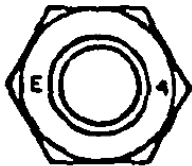

Mfr. Symbol/Logo letter "E" as shown, opposite material symbol marking code on nut crown at corners.



Mfr. Symbol/Logo letter "E", as shown on nut crown, 180 degrees opposite material symbol marking.



Mfr. Symbol/Logo letter "E" marked opposite material symbol code marking on nut crown at one corner location.

CAGE code: 19968
 Continued

1/

Continued

ENGINEERING MATERIALS CO., INC.



Mfr. Symbol/Logo letter "E" marked opposite material symbol code marking on nut crown at one corner location.



Mfr. Symbol/Logo letter "E" marked on crown, 180 degrees opposite thread designation letter.



Mfr. Symbol/Logo letter "E" indent marked above material symbol.





Mfr. Symbol/Logo letter "E" as shown marked above material symbol marking on stud or rod end.

CAGE code: 19968

1/

^{1/} Information published in this revision was verified by direct contact with manufacturers.

^{2/} Information not verified to be current, no response from manufacturer. Information identical to that published in MIL-HDBK-57, Revision B.











<p>ENGLER MANUFACTURING COMPANY, INC., THE 304 W. ERVING AVE. SOUTH BEND, IN 46613</p> <p style="text-align: center;">EM F593 T</p> <p>CAGE code: 0XYS0 2/</p>
<p>ENOMOTO INDUSTRIES CO., LTD. 3-26 TAKASAGO, TAKAISHI-SHI, OSAKA, 592 JAPAN</p> <p style="text-align: center;"></p> <p>CAGE code: S0132 2/</p>
<p>ERICO FASTENING SYSTEMS 301 NEW ALBANY ROAD MOORESTOWN, NJ 08057</p> <p style="text-align: center;">E E  ○ ○ E E ○ ○</p> <p>CAGE code: 84483 2/</p>

<p>ERIE BOLT CORP. 1325 LIBERTY STREET ERIE, PA 16502</p> <p>see EBC INDUSTRIES</p> <p style="text-align: center;">ERIE E</p> <p>CAGE code: 5G920 2/</p>
<p>ESCO PRECISION, INC. 71 OLD CAMPLAIN RD. HILLSBOROUGH, NJ 08844</p> <p style="text-align: center;">EPI</p> <p>CAGE code: 1YRR0 1/</p>
<p>ESMET, INC.</p> <p>DBA ELECTROLINE TTUFLOC 1406 5TH ST., S.W. CANTON, OH 44702-2062 CAGE code: 79931</p> <p>SUB OF UNIMET CORP 1406 5TH ST., S.W. CANTON, OH 44702-2062 CAGE code: 0EA31</p> <p style="text-align: center;"></p> <p>CAGE code: 79931, 0EA31 1/</p>

1/ Information published in this revision was verified by direct contact with manufacturers.

2/ Information not verified to be current, no response from manufacturer. Information identical to that published in MIL-HDBK-57, Revision B.

<p>ESNA (MACLEAN-FOGG COMPANY) 611 COUNTRY CLUB ROAD POCAHONTAS, AR 72455-8803</p> <p>E, EN, or ESNA Red nylon insert in locknuts</p> <p>Red nylon insert in locknuts identifies Esna as manufacturer</p>  <p>CAGE code: 019L2 2/</p>
<p>ESP MANUFACTURING CO., INC. 2331 E. INTERSTATE 20 P O BOX 871 ODESSA, TX 79766-8827</p> <p style="text-align: center;">EΣΠ</p> <p>CAGE code: 7J504 1/</p>
<p>ESSENTIAL MACHINING 354 HERBERTSVILLE ROAD BRICK, NJ 08724-1735</p>  <p>CAGE code: 0TR19 1/</p>
<p>ESTA PRODUCTS COMPANY 16 MISSOURI DRIVE WARWICK, RI 02886-8117</p> <p style="text-align: center;">ESTA</p> <p>CAGE code: 8R230 2/</p>

<p>EVERLOCK FASTENING SYSTEMS EVERLOCK DETROIT DIVISION 6567 SOUTH STERLING DRIVE STERLING HEIGHTS, MI 48077</p>	
<p>Microlock</p>  <p>Prevailing torque surface</p>	<p>Hi-Hex Microlock</p>  <p>Prevailing torque surface</p>
<p>Flange Hi-Hex Microlock</p>  <p>Prevailing torque surface</p>	
<p>Flange Toplock</p>  	
<p>Flange Nut</p>  	
<p>Nut and Washer Assembly</p>  	
<p>Standard Hex Nut</p>  	
<p>CAGE code: Continued 2/</p>	

1/ Information published in this revision was verified by direct contact with manufacturers.

2/ Information not verified to be current, no response from manufacturer. Information identical to that published in MIL-HDBK-57, Revision B.

EVERLOCK FASTENING SYSTEMS
Continued

GREER STOP NUT
(Greer-Smyrna Division)
481 McNALLY DRIVE
NASHVILLE, TN 37211

Green nylon insert identifies Greer-Smyrna as manufacturer

6 equally spaced stakes identifies Grade B

6 equally spaced stakes plug notch in corner of hex identifies Grade C

NYLON INSERT

Grade markings per IFI Standard 100 (one or two small notches cut circumferentially into each of the six corners at about mid-height)

Grade B CONELOCK INCH MARKINGS Grade C

Green nylon insert identifies Greer-Smyrna as manufacturer per IFI 514

Property Class 5, 9 and 10 markings per IFI 514 located on bearing surface and/or hex flats

NYLON INSERT

Manufacturer's I.D. - letter "G" stamped on one hex flat or on bearing surface

CONELOCK - BEARING SURFACE

Class 5 METRIC MARKINGS Class 10 Class 9

CAGE code: 27687 2/

Continued

Continued
EVERLOCK FASTENING SYSTEMS

INTERNATIONAL SCREW DIVISION
50631 EAST RUSSEL SCHMIDT BOULEVARD
MOUNT CLEMENS, MI 48045

I Upper case Lower case less

CAGE code: 2/

EXCEL PRECISION PRODUCTS, INC.
2207 NW 30TH PL.
POMPANO BEACH, FL 33069-1026

X

CAGE code: 1H4K6 2/

EXPERIMENTAL MACHINE CO.
1412 SHOEMAKER RD.
BALTIMORE, MD 21209

EMC

CAGE code: 0NAP8 2/

FABER ENTERPRISES, INC.
6606 VARIEL AVE.
CANOGA PARK, CA 91303-2808

FE

CAGE code: 14397 1/

1/ Information published in this revision was verified by direct contact with manufacturers.

2/ Information not verified to be current, no response from manufacturer. Information identical to that published in MIL-HDBK-57, Revision B.

<p>FABRICATION SPECIALTY INC. 6530 SMOKY HILL CT. GRANBURY, TX 76049-7042</p> <p>FS or 28548</p> <p>CAGE code: 28548 <u>1/</u></p>
<p>FABSCO CORP. 1745 W. 124TH ST. CHICAGO, IL 60643-5345</p> <p>F</p> <p>CAGE code: 4S619 <u>2/</u></p>
<p>FAILING CO., GEORGE E. P.O.BOX 872 ENID, OK 73702</p> <p>F</p> <p>CAGE code: <u>2/</u></p>
<p>FALCON MANUFACTURING CORP. 10409-B OLD ATLANTA HWY. COVINGTON, GA 30014-0887</p> <p>FMC 1</p> <p>CAGE code: 0HM72 <u>2/</u></p>
<p>FALL RIVER MANUFACTURING CO., INC. 540 CURRANT ROAD FALL RIVER, MA 02720-4711</p> <p>fr f</p> <p>CAGE code: 1JWL5 <u>1/</u></p>

<p>FANG SHENG SCREW CO., LTD. #113 LANE 96 MINCHAUN ROAD LU CHU HSIANG, KAOHSIUNG HSIEN, 821, TAIWAN</p> <p>YFS FANG SHENG SCREW CO. LTD</p> <p>CAGE code: SJ544 <u>2/</u></p>
<p>FARIAS INDUSTRIAL MACHINING 504 BRUNKEN AVENUE, STE L SALINAS, CA 93901</p> <p>(No artwork for marking. Marks whatever the customer specifies.)</p> <p>CAGE code: 3KWY7 <u>1/</u></p>
<p>FARLO MACHINE & TOOL CO., INC 340 CONSTANCE DR BLDG # 7 WARMINSTER, PA 18974-2815</p> <p>FM</p> <p>CAGE code: 7S305 <u>2/</u></p>

1/ Information published in this revision was verified by direct contact with manufacturers.

2/ Information not verified to be current, no response from manufacturer. Information identical to that published in MIL-HDBK-57, Revision B.

(FASSCO) FASTENER & STEEL SUPPLY CO., LTD.
 Quality Assurance Dept.
 P.O. BOX 236
 HATFIELD, PA 19440

Plant
 2294 NORTH ROAD
 HATFIELD, PA 19440

F **F**

Latest marking used on fasteners after August 1, 1988

Previous marking used on fasteners

CAGE code: 2/

FASTENAL COMPANY
 2001 THEURER BLVD.
 WINONA, MN 55987-1500

Plant
 FASTENAL COMPANY MFG DIV
 1801 THEURER BLVD.
 WINONA, MN 55987-1500
 CAGE code: 1QNZ3

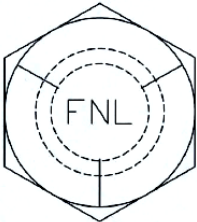

CAGE code: 0Y3H3 1/

FASTENER BROKERAGE INC
 DBA INOFAST MANUFACTURING
 SUITE R 2880 BERGEY RD
 HATFIELD, PA 19440 - 3241

IN

CAGE code: 2T359 2/

FASTENER INNOVATION TECHNOLOGY, INC.
 DBA F.I.T.
 14601 S. BROADWAY STREET
 GARDENA, CA 90248-1811

FIT

CAGE code: 58998 1/

FASTENER TECHNOLOGY CORP.
 7415 FULTON AVE
 NORTH HOLLYWOOD, CA 91605-5411

FT

CAGE code: 58794 1/

FASTENING PRODUCTS CO.,INC.
 P.O. BOX 261
 CLIFTON HIGHTS, PA 19018-0334

Plant
 3 MERION TERRACE
 CLIFTON HEIGHTS, PA 19018-0334



CAGE code: 6M389 1/

1/ Information published in this revision was verified by direct contact with manufacturers.

2/ Information not verified to be current, no response from manufacturer. Information identical to that published in MIL-HDBK-57, Revision B.

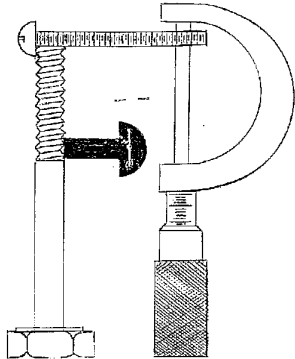
<p>FASTENING PRODUCTS OF LANCASTER, INC. 1980 OLD PHILADELPHIA PIKE LANCASTER, PA 17602-3498</p>  <p>CAGE code: 4M097 1/</p>
<p>FASTENRATH BEFESTIGUNGSTECHNIK GmbH HERSCHEIDER STRABE 105 POSTFASH 51 42 58840 PLETTENBERG, HOLTAUSEN FEDERAL REPUBLIC OF GERMANY</p> <p style="text-align: center; font-size: 2em;">F</p> <p>CAGE code: 1/</p>
<p>FASTI-WERK CARL AUG. FASTENRATH GMBH & CO.KG INDUSTRIEGEBIET ELBRINGHAUSEN P.O. BOX 1250 WERMELSKIRCHEM, GERMANY 42929</p> <p style="text-align: center; font-size: 2em;">F</p> <p>CAGE code: D9500 2/</p>

<p>FASTRON COMPANY, THE 11800 FRANKLIN AVENUE FRANKLIN PARK, IL 60131-1006</p> <p style="text-align: center; font-size: 2em;">F</p> <p>CAGE code: 24929 2/</p>
<p>FEDERAL EQUIPMENT COMPANY 707 CARR ST CINCINNATI, OH 45203-1211</p> <p style="text-align: center; font-size: 1.5em;">F E C</p> <p style="text-align: center; font-size: 1.5em;">6 0 5 8 7</p> <p>CAGE code: 60587 1/</p>
<p>FEDERAL MANUFACTURING CORP. 9825 DE SOTO AVENUE CHATSWORTH, CA 91311-1441</p> <p style="text-align: center; font-size: 2em;">F M C</p> <p>CAGE code: 17943 2/</p>

1/ Information published in this revision was verified by direct contact with manufacturers.

2/ Information not verified to be current, no response from manufacturer. Information identical to that published in MIL-HDBK-57, Revision B.

FEDERAL SCREW WORKS
2400 BUHL BUILDING
DETROIT, MI 48226

BIG RAPIDS DIVISION
400 NORTH DEKRAFT
BIG RAPIDS, MI 49307

HEX BOLTS (INCH) FLANGE BOLTS (INCH)

CONNECTING ROD BOLTS

BALL STUDS (THREADED END SHOWN)

ROMULUS DIVISION
34846 GODDARD ROAD
ROMULUS, MI 48174-3400

PREVAILING TORQUE NUTS

HEX NUTS (INCH) HEX NUTS (GRADE 8) 2 SIDE CRIMP

FLANGE NUTS (INCH) FLANGE NUTS (CLASS 10)

HEX NUTS (METRIC) (OPTIONAL) HEX NUTS (METRIC)

FLANGE NUTS (METRIC) (OPTIONAL) FLANGE NUTS (METRIC)

TOP LOCK 2 SIDES PERMA-TORQUE

COLLAR HEX NUTS (METRIC) COLLAR HEX NUTS (OPTIONAL) COLLAR HEX NUTS (INCH)

CAGE code: 21957 2/

FENBAR PRECISION MACHINISTS, INC
633 COMMERCE STREET
THORNWOOD, NY 10594-1348

CAGE code: IP472 1/

FENTON HEADING
2480 OWEN RD.
FENTON, MI 48430

CAGE code: 1/

FERNDALE FASTENER
31600 STEPHENSON HIGHWAY
MADISON HEIGHTS, MI 48071

CAGE code: 2/



FERRIERE DI STABIO, S.A.
VIA AL MULINO
STABIO, SWITZERLAND CH-6855

F S

CAGE code: 2/

1/ Information published in this revision was verified by direct contact with manufacturers.

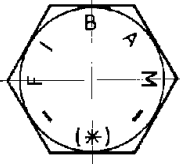
2/ Information not verified to be current, no response from manufacturer. Information identical to that published in MIL-HDBK-57, Revision B.

<p>FERRY CAP & SET SCREW CO., THE 2151 SCRANTON RD. CLEVELAND, OH 44113-3578</p> <p>FC · F-C BPG</p> <p>CAGE code: 84513 2/</p>
<p>FIBAM COMPANHIA INDUSTRIAL SAO BERNARDO DO CAMPO P.O. BOX 360 SAO PAULO, BRAZIL C.E.P.0 09701.907</p>  <p>CAGE code: 1/</p>
<p>FILETAGE INTERNATIONAL (INTERNATIONAL THREAD INC.) 2225 RUE MICHLIN LAVAL, QUE, CANADA H7L9Z7</p>  <p>CAGE code: 2/</p>
<p>FIRST AMERICAN SALES CO. 2706 ST. LOUIS AVE. LONG BEACH, CA 90806-2026</p> <p>fst</p> <p>CAGE code: 58251 2/</p>

<p>FISCHER SPECIAL MFG. CO. 11 INDUSTRIAL RD. COLD SPRING, KY 41076-9796</p>  <p>CAGE code: 73743 2/</p>
<p>FITZ MANUFACTURING INDUSTRIES LTD DBA FMI 6625 IRON HORSE BLVD. NORTH RICHLAND HILL, TX 76180</p> <p>05DT8 </p> <p>CAGE code: 05DT8 1/</p>
<p>FLAIG & HOMMEL HEERSTRASSE 1 ALDINGEN, GERMANY 78554</p> <p>FS Company logo to be stamped and used on all steel reusable FLAG & HOMMEL lock nuts.</p> <p>FH Company logo to be stamped on all none reusable (standard) nuts.</p> <p>CAGE code: C3816 2/</p>

1/ Information published in this revision was verified by direct contact with manufacturers.

2/ Information not verified to be current, no response from manufacturer. Information identical to that published in MIL-HDBK-57, Revision B.

FLEXALLOY INC.
26000 RICHMOND ROAD
BEDFORD, OH 44146



GRADE 5
HEX HEAD
CAP SCREW

GRADE 8
HEX HEAD
CAP SCREW

FX-180 HEX HEAD
CAP SCREW
(180,000 PSI
MINIMUM TENSILE
STRENGTH)



FX-180 HEX NUT
PROOF LOAD =
180,000 PSI



METRIC CAP SCREW,
PROPERTY CLASS 10.9

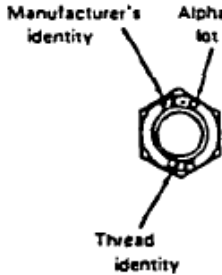

Outer Cap Wheel Nut

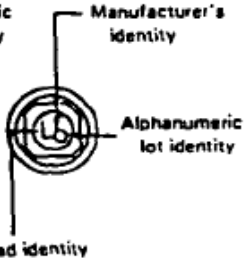

Inner Cap Wheel Nut

WHEEL NUTS



HEX FLANGE SCREW GRADE 8

CAGE code: 0C9A2 2/

FLORES ENTERPRISES
1729 E. 28TH STREET
SIGNAL HILL, CA 0806-1923



CAGE code: 0V616 1/

FLUIDONICS INC.
205 W INDUSTRY CT
P. O. BOX 9020
DEER PARK, NY 11729



CAGE code: 58525 2/

FLUIDYNE CORPORATION
9100 COLLINS AVE.
PENNSAUKEN, NJ 08110



CAGE code: 9Y957 1/

FOLSOM TOOL & MOLD CORP.
12 MOUNT PLEASANT DR.
ASTON, PA 19014-4140



CAGE code: 6P049 2/

FONTAL CONTROLS, INC.
12725 ENCINITAS AVENUE
SYLMAR, CA 91342-3517



CAGE code: 0GNC3 2/

1/ Information published in this revision was verified by direct contact with manufacturers.

2/ Information not verified to be current, no response from manufacturer. Information identical to that published in MIL-HDBK-57, Revision B.

FONTANA S.A.
 FONTANA LUIGI SPA
 VIA PIAVE 29
 VEDUGGIO MILANO,
 ITALY 20050

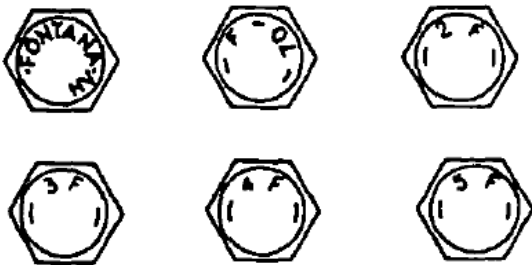
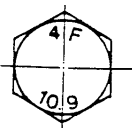
Bolts and screws
 Hexagon Head
 Strength Grade 10.9
 Iso Metric Thread

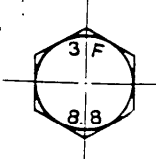

Bolts and screws
 Hexagon Head
 Strength Grade 8.8
 Iso Metric Thread

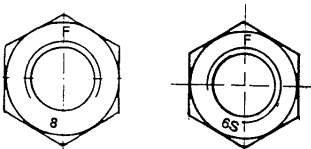

Nut
 Strength Class 8
 Iso Metric Thread

CAGE code: A4733 2/

FOREMOST PRECISION INSTRUMENT
 CORP.
 31 CARLETON AVE
 MT VERNON, NY 10550-4617

FPIC

CAGE code: 33464 2/

FOREST FASTENERS
 TREForest INDUSTRIAL ESTATE
 PONTYPRIDD, MID. GLAMORGAN,
 SOUTH WALES, GREAT BRITAIN
 CF37 5YG



CAGE code: 2/

FORMED FASTENER MANUFACTURING,
 INC.
 7247 S. 78TH AVE
 BRIDGEVIEW, IL 60455

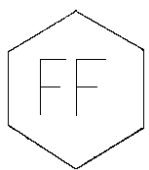

CAGE code: 2/

FPA MANUFACTURING
 DBA FPA MANUFACTURING AND SUPPLY
 6733 S SEPULVEDA BLVD STE 245
 LOS ANGELES, CA 90045-1525

FPA

CAGE code: 0J6Z1 2/

FRANROE PRECISION MACHINE
 COMPANY
 12 CHAMPION RD
 GLOUCESTER CITY, NJ 08030

F.R.
 F.R.P

CAGE code: 40650 2/

^{1/} Information published in this revision was verified by direct contact with manufacturers.
^{2/} Information not verified to be current, no response from manufacturer. Information identical to that published in MIL-HDBK-57, Revision B.

FREEMAN CO.
P. O. BOX 57
719 WALNUT ST
YANKTON, SD 57078

F

CAGE code: 84596 1/

FRIEDR BOESNER GMBH
AUGUSTHENALER STRABE
5450 NEUWIED 13
GERMANY



CAGE code: 2/

FRISBY AEROSPACE INC DE
DIV TRIUMPH ACTUATION SYSTEMS -
CLEMMONS
417 S.MAIN ST.
FREEPORT, NY 11520-5144

was FRISBY AIRBORNE HYDROLICS, INC

FAH

CAGE code: 26437 2/

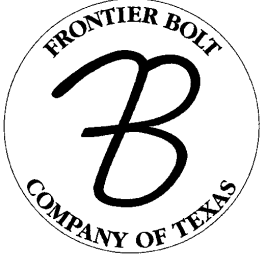

FRONTIER BOLT COMPANY OF TEXAS
555 AIRPORT DRIVE
MANSFIELD, TX 76063-2715



CAGE code: 1CE65 2/

FUCHS SCHRAUBENWERK GmbH
BISMARCKSTRASSE 24
5900 SIEGEN
GERMANY D-57076

Hex head/round head bolts, stud bolts

T-head bolts, hammer head/ hook head bolts

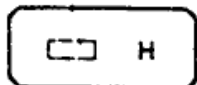
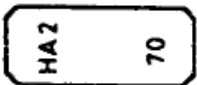
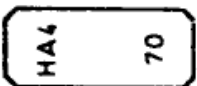

High strength structural bolts (tension controlled/ twist off)



CAGE code: 1/

1/ Information published in this revision was verified by direct contact with manufacturers.



2/ Information not verified to be current, no response from manufacturer. Information identical to that published in MIL-HDBK-57, Revision B.

<p>G & R SCREW MACHINE PRODUCTS 21602 N. CENTRAL AVE. SUITE 5 PHOENIX, AZ 85024</p> <p>G & R</p> <p>CAGE code: 7Y137 <u>2/</u></p>	<p>GAITHER PATRICIA DBA GAITHER MACHINE 201 PILGRIM LANE P. O. BOX 202 MUNFORD, AL 36268-4212</p> <p>GMF</p> <p>CAGE code: 1BTX4 <u>2/</u></p>
<p>G & S MACHINE INC. 2804 RENEE DRIVE BEDFORD, TX 76021-5208</p> <p>G-S</p> <p>CAGE code: 62925 <u>2/</u></p>	<p>GALAN PRECISION MACHINE CO. 8912 LANKERSHIM BLVD. SUN VALLEY, CA 91352</p> <p>G GPM</p> <p>CAGE code: 0S1P8 <u>2/</u></p>
<p>G. B. MACHINE PRECISION, INC. 4140C AUSTIN BLVD ISLAND PARK, NY 11558-1727</p> <p>G.B.M</p> <p>CAGE code: 03KF3 <u>2/</u></p>	<p>GALMAC MFG CO. 565 COVINA BOULEVARD SAN DIMAS, CA 91773-2911</p>  <p>CAGE code: 4V765 <u>2/</u></p>
<p>G.B. DUPONT CO., INC 500 WEST LONG LAKE ROAD TROY, MI 48098</p>  <p>CAGE code: <u>2/</u></p>	<p>GARCIA INDUSTRIES, INC. 12345 FLORENCE AVENUE SANTA FE SPRING, CA 90670-3807</p>  <p>CAGE code: 1RYN7 <u>2/</u></p>

^{1/} Information published in this revision was verified by direct contact with manufacturers.



^{2/} Information not verified to be current, no response from manufacturer. Information identical to that published in MIL-HDBK-57, Revision B.



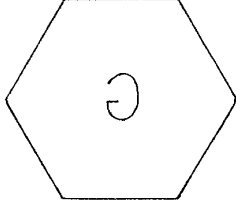

<p>GARDINER MFG. CO. P.O. BOX 1499 OAKLAND, CA 94604</p> <p style="text-align: center;">GARCO</p> <p>CAGE code: 24042 <u>2/</u></p>
<p>GATES ALBERT, INC. 3434 UNION ST. NORTH CHILI, NY 14514-9731</p> <p style="text-align: center;">GAI</p> <p>CAGE code: 4ZBMI <u>1/</u></p>
<p>GATEWAY SCREW AND RIVET, INC. 2670 UNINTED LANE ELK GROVE VILLIAGE, IL 60007</p> <p style="text-align: center;">G</p> <p>CAGE code: <u>2/</u></p>
<p>GEN FAST MANUFACTURING COMPANY 225 HENRY STREET, BLDG. 5 BRANTFORD, ONTARIO CANADA N3T 6H2</p> <p style="text-align: center;"></p> <p>CAGE code: <u>2/</u></p>
<p>GENERAL AVIATION MFG., INC. 2693 PHILMONT AVE HUNTINGDON VALLEY, PA 19006-5301</p> <p style="text-align: center;">4J952</p> <p>CAGE code: 4J952 <u>2/</u></p>

<p>GENERAL MACHINE PRODUCTS, INC. 3525 VICKERY BLVD FORT WORTH, TX 76105</p> <p style="text-align: center;"> </p> <p>CAGE code: <u>2/</u></p>
<p>GENERAL SCREW & SPECIALTY CO., INC. 14 N. BLEEKER ST. MT VERNON, NY 10550</p> <p style="text-align: center;">GS</p> <p>CAGE code: 26300 <u>2/</u></p>
<p>GERMAN MACHINED PRODUCTS, INC. 1208 S. HOOVER ST. GARDENA, CA 90247-1771</p> <p style="text-align: center;"></p> <p>CAGE code: 65813 <u>2/</u></p>
<p>GERTLER INDUSTRIES, INC. 914 W. 17TH STREET COSTA MESA, CA 92627-4403</p> <p style="text-align: center;">GII</p> <p>CAGE code: 64445 <u>2/</u></p>

^{1/} Information published in this revision was verified by direct contact with manufacturers.



^{2/} Information not verified to be current, no response from manufacturer. Information identical to that published in MIL-HDBK-57, Revision B.

<p>GFD LETAGE ZONE INDUSTRIELLE BP 63 BOURGNE FRANCE 90140</p> <p>Plant 15. IMPASSE G. THIVOLLET P.O. BOX 26 42011 SAINT ETIENNE CEDEX 2 FRANCE</p>  <p>CAGE code: F1471 2/</p>
<p>GILL MACHINE & TOOL CO. 200 PRAIRIE STREET ROCKFORD, IL 61107</p>  <p>CAGE code: 0H8Y5 2/</p>
<p>GL CNC SERVICE INC. 9860 OWENSMOUTH AVE #3 CHATSWORTH, CA 91311-3852</p>  <p>CAGE code: 1DUA6 1/</p>

<p>GMJ MACHINE COMPANY, INC. 251 STATE LINE RD S WILMER, AL 36587-7051</p>  <p>CAGE code: 8T119 2/</p>
<p>GMP CO. CORPORATION 529 8TH AVE. BETHLEHEM, PA 18018-5008</p>   <p>CAGE code: 51867 2/</p>
<p>GOSHO WORKS, LTD. 3-8-1 TARU-MACHI KOHOKU, YOKOHAMA 222 JAPAN</p>  <p>CAGE code: 2/</p>

1/ Information published in this revision was verified by direct contact with manufacturers.

2/ Information not verified to be current, no response from manufacturer. Information identical to that published in MIL-HDBK-57, Revision B.

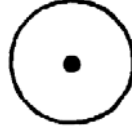
<p>GRACO INDUSTRIES, INC. 44605 MACOMB INDUSTRIAL DRIVE CLINTON TOWNSHIP, MI 48096-1148</p>  <p>CAGE code: 1GT22 <u>1/</u></p>	<p>GRAUCH ENTERPRISES RR 1 BOX 37 1878 PORT MATILDA HWY PHILLIPSBURG, PA 16866-3128</p>  <p>CAGE code: 1HU38 <u>1/</u></p>
<p>GRADON SCREW MACHINE CORP. P. O. BOX 1080 1411 EAST ST. NEW BRITIAN, CT 06050-1080</p>  <p>CAGE code: 69870 <u>2/</u></p>	<p>GREATER MARYLAND TOOL & MFG., CORP. 5 RESOURCE AVE MOUNTAIN LAKE PARK, MD 21550-6362</p> <p style="text-align: center;">GMT</p> <p>CAGE code: 34549 <u>1/</u></p>
<p>GRANDUER FASTENERS, INC. 18798 E. HWY 10 DANVILLE, AR 72833-0658</p> <p style="text-align: center;">GF</p> <p>CAGE code: 3U752 <u>1/</u></p>	<p>GREEN BAY DROP FORGE DIV. OF CLEVELAND HARDWARE & FORGING 1341 S. STATE ST. P.O. BOX 11797 GREEN BAY, WI 54307-1797</p> <p>See CLEVELAND HARDWARE & FORGING</p>  <p style="text-align: right;"><i>Circle with center dot</i></p> <p>CAGE code: 08277 <u>2/</u></p>

1/ Information published in this revision was verified by direct contact with manufacturers.

2/ Information not verified to be current, no response from manufacturer. Information identical to that published in MIL-HDBK-57, Revision B.

GREENFIELD MANUFACTURING CO., INC.
920 LEVICK STREET
PHILADELPHIA, PA 19111-5422

GFM

CAGE code: 98320

2/

GREER STOP NUT
481 MCNALLY DRIVE
NASHVILLE, TN 37211-3311

G S_GL

Green nylon insert

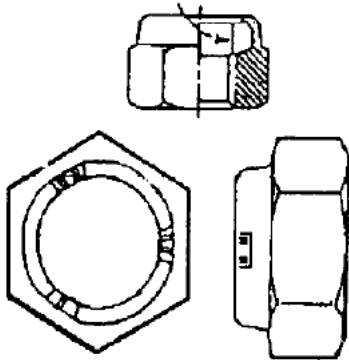

Manufacturer identification:
2 raised ribs in (2) crimp depressions
1 raised rib in (1) crimp depression

NFB

for head marking on
bolts and screws

CAGE code: 27687

1/

GRIPCO, DIVISION OF BLACK & DECKER
111 E. BROAD ST.
SOUTH WHITLEY, IN 46787

GN

Raised or indented on flange or bearing surface of bolts
Raised on head of bolts, inch or metric
Raised or indented on flange or bearing surface of nuts

GF



GN

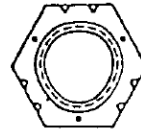

Twin Delta
Crownlock grade
B inch locknut

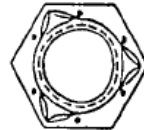

Gripco Crown lock
Grade C inch
locknut

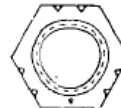

Twin Delta
Crownlock
Class 9 metric
locknut



Gripco
Crownlock
Class 10
metric locknut



Toplock
(3-6
Indentations)



Centerlock

CAGE code: 0KS39

2/

1/ Information published in this revision was verified by direct contact with manufacturers.

2/ Information not verified to be current, no response from manufacturer. Information identical to that published in MIL-HDBK-57, Revision B.

GROOV-PIN CORPORATION
 331 FARNUM PIKE
 SMITHFIELD, RI 02917-1205



G-P

CAGE code: 73957 2/

GRUPO RASSINI S.A. de C.V.
 RASSINI INTERNATIONAL, INC.
 617 EAST HURON STREET
 ANN HARBOR, MI 48104

Plant
 TORNILLOS RASSINI S.A. de C.V.
 AV. ELECTRICIDAD Y.E. PUGIBEL
 CD. INDUSTRIAL, XALOSTOC
 STA. CARLA, EDO DE MEXICO
 APARTADO POSTAL 14-711
 MEXICO D.F.

RR

Used to mark the following products:

- hex cap screws
- hex bolts
- hex nuts
- heavy hex structural bolts
- heavy hex nuts
- shackle bolts
- hex cone nuts
- wheelbolts

CAGE code: 2/

GS AEROSPACE
 DIV. B & B SPECIALTIES INC
 4321 E LA PALMA AVE.
 ANAHEIM , CA 92807-1805

See B & B SPECIALTIES INC

1) PRIMARY - **GS**

2) SECONDARY - **GSAT**

3) SECONDARY - **1EM77**

4) SECONDARY - **GSI**
 (OBSOLETE AS OF
 JAN 1, 1988)

CAGE code: 1EM77 1/

GSF FASTENING (Armstrong Fastening Ltd.)
 MIDLAND ROAD
 DARLASTON
 WEDNESBURY, WEST MIDLANDS WS10 8JN
 GREAT BRITAIN









CAGE code: 2/

1/ Information published in this revision was verified by direct contact with manufacturers.

2/ Information not verified to be current, no response from manufacturer. Information identical to that published in MIL-HDBK-57, Revision B.



<p>GUARDIAN RIVET & FASTENER Guardian Mfg. Division 70 AIR PARK DRIVE RONKONKOMA, NY 11779</p> <p>Plant 201 TRADE ZONE DRIVE RONKONKOMA, NY 11779</p> <div style="display: flex; justify-content: space-around;">   </div> <p>CAGE code: 2/</p>
<p>GUNNISON-INTERNATIONAL INC. 861 GIBBSBORO ROAD CLEMENTON, NJ 08021-1207</p> <div style="text-align: center; font-size: 2em;">GTT</div> <p>CAGE code: 4G922 2/</p>
<p>H C MERCHANDISERS INC. DBA H C PACIFIC 19844 QUIROZ CT WALNUT, CA 91789-2828</p> <div style="text-align: center; font-size: 2em;">HC HCP</div> <p>CAGE code: 53037 2/</p>
<p>H C PACIFIC 19844 QUIROZ CT WALNUT, CA 91789 - 2828</p> <div style="text-align: center; font-size: 2em;">HC HCP</div> <p>CAGE code: 53037 2/</p>

<p>H. MULLINS, LTD. (BADE INDUSTRIAL ESTATE) JARROW TYNE AND WEAR CO DURHAM, UNITED KINGDOM NE32 3EX</p> <div style="text-align: center; font-size: 4em;">HM</div> <p>CAGE code: 2/</p>
<p>H. PAULIN & CO. LTD. (CAPITAL METAL INDUSTRIES DIVISION) 55 MILNE AVE. SCARBOROUGH, ONTARIO CANADA MIL 4N3</p> <div style="display: flex; justify-content: space-around;">   </div> <div style="display: flex; justify-content: space-around; margin-top: 10px;"> <p><i>Hex head cap screws</i></p> <p><i>Metric standard hex head cap screws</i></p> </div> <p>CAGE code: 95119 2/</p>
<p>H. PRINZ GmbH FABRIK FUR VERBINDUNGSELEMENTE 5970 PLETTENBERG POSTBOX 5241 GERMANY</p> <div style="display: flex; justify-content: center; gap: 20px;">     </div> <p>CAGE code: 2/</p>

1/ Information published in this revision was verified by direct contact with manufacturers.

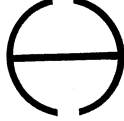

2/ Information not verified to be current, no response from manufacturer. Information identical to that published in MIL-HDBK-57, Revision B.

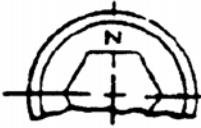





<p>HABINA ENGINEERING 4740 COTTON BELT SAN ANTONIO, TX 78219-2854</p>  <p>CAGE code: 1SZT7 1/</p>
<p>HALL INDUSTRIES INC. (FORMERLY STANDARD TOOL & MACHINE COMPANY) 514 MECKLEM LANE ELLWOOD CITY, PA 16117-3028</p>  <p>CAGE code: 29281 1/</p>
<p>HALLSIMS INDUSTRIAL COMPONENTS, INC. 37 TERRY DR. TREVOSE, PA 19053</p>  <p>CAGE code: 8V986 2/</p>

<p>HAMANAKA (THAILAND). CO., LTD. NO. 550 Moo6 TAIBAN ROAD AMPHUR MUANG, SAMUTPRAKARN, THAILAND</p>  <p>Plant HAMANAKA NUT MFG. CO., LTD KO-770 SHIRAHANA-CHO, HIMEJI-SHI HYOGO, JAPAN</p>  <p>CAGE code: 5Z615 1/</p>
<p>HANDI GADETS CORP. P.O. BOX 0938 LA CROSSE, WI 54603</p> <p>Plant 1230 CLINTON ST. LA CROSSE, WI 54603</p>  <p>CAGE code: 1M893 1/</p>
<p>HANSAN SCREW CO., LTD. EXPORTING DEPARTMENT 974-7 YANG DUK-DONG MASAN 610-00 KOREA</p>  <p>CAGE code: 2/</p>

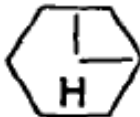
1/ Information published in this revision was verified by direct contact with manufacturers.

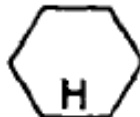

2/ Information not verified to be current, no response from manufacturer. Information identical to that published in MIL-HDBK-57, Revision B.

<p>HARDWARE SPECIALTY CO, INC. 48-75 36TH STREET LONG ISLAND CITY, NY 11101-1994</p>  <p>CAGE code: 07679 <u>1/</u></p>
<p>HARRISON BOLT & NUT CO., THE 2781 WILKENS AVE. BALTIMORE, MD 21223</p>  <p>CAGE code: 5B735 <u>2/</u></p>
<p>HARTFORD AIRCRAFT PRODUCTS, INC. 94 OLD POQUONOCK ROAD BLOOMFIELD, CT 06002-1427</p>  <p>CAGE code: 66861 <u>2/</u></p>
<p>HARWOOD DESIGN, INC. 1507 CLYDE WAITE DRIVE BRISTOL, PA 19007-2919</p> <p style="text-align: center; font-size: 2em;">HDI</p> <p>CAGE code: 1VQQ8 <u>2/</u></p>

<p>HASKELL OF HUNTINGTON, INC. P.O. BOX 119 HUNTINGTON, WV 25706-0119</p> <p>Plant 300 THIRD AVENUE HUNTINGTON, WV 25701</p>  <p>300 Series Stainless Steel</p>  <p>Type 316 Stainless Steel</p>   <p>Nickel Copper (Monel)</p>  <p>Silicon Bronze</p> <p>CAGE code: <u>2/</u></p>
<p>HASSALL, JOHN, INC. 609-1 CANTIAGUE ROCK RD WESTBURY, NY 11590-1721</p>  <p>CAGE code: 82224 <u>1/</u></p>

1/ Information published in this revision was verified by direct contact with manufacturers.

2/ Information not verified to be current, no response from manufacturer. Information identical to that published in MIL-HDBK-57, Revision B.

<p>HATCH INDUSTRIES 17000 S WSTN AVE STE 22 GARDENA, CA 90247-5262</p>  <p>CAGE code: 03AJ8 <u>2/</u></p>
<p>HAWTHORNE BOLT WORKS P.O. BOX 474 VALLEY CITY, OH 44280</p> <p style="text-align: center;">Plant 355 A LAKE RD. MEDINA, OH 44256</p>  <p>GRADE 2 GRADE 5 GRADE 8</p> <p>CAGE code: 4TU98 <u>1/</u></p>
<p>HAYDON BOLTS, INC. 1181 UNITY ST PHILADELPHIA, PA 19124-3104</p>  <p>CAGE code: 2S013 <u>2/</u></p>

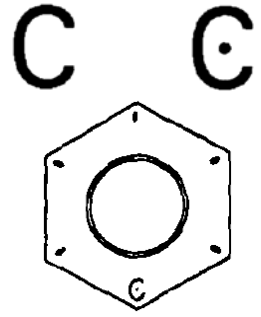
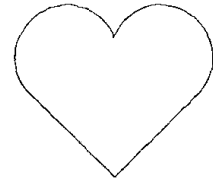
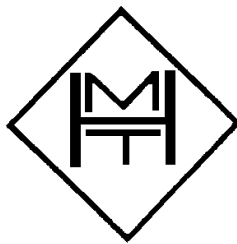
<p>HAZE SEIKO CO., LTD. KO 402 SHIRAHAMA- CHO HIMEJI-SHI, HYOUGO-KEN, JAPAN 672</p>  <p>CAGE code: <u>2/</u></p>
<p>HEARTLAND PRECISION FASTENER 301 PRAIRIE VILLAGE DR NEW CENTURY, KS 66031-1121</p>  <p>CAGE code: 0ZC92 <u>1/</u></p>
<p>HEIM'S MACHINE & TOOL, INC. 36 EVERGREEN ROAD LEBANON, PA 17042</p>  <p>CAGE code: 0B117 <u>1/</u></p>

1/ Information published in this revision was verified by direct contact with manufacturers.

2/ Information not verified to be current, no response from manufacturer. Information identical to that published in MIL-HDBK-57, Revision B.

HEITCO MANUFACTURING, INC.
 60 TUTTLE ROAD
 MIDDLETOWN, CT 06457

HTC

CAGE code: 2/

HEMCO TOOL INC.
 7 SOUTH MAPLE ST.
 P.O. BOX 326
 WESTFIELD, MA 01085-4338

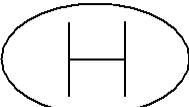

CAGE code: 5R108 2/

HENWAY, INC.
 1314 GOODRICK DRIVE
 P.O. BOX 1276
 TEHACHAPI, CA 93561

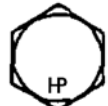
HP 

CAGE code: 0X6T3 2/

HEPTNER MFG CO.
 RIVER ROAD BLDG. PP-1 JAY-CEE
 INDUSTRIAL PARK
 BRISTOL, PA 19007 - 6103

7

CAGE code: 05BZ4 1/

HESSISCHE SCHRAUBENFABRIK WELTER
 GmbH & CO., KG
 STEPHAN-NIDEREHE-STR. 6
 P. O. BOX 13 40
 MARBURG, GERMANY 35037



CAGE code: D5396 2/

HEWINS, EDMOND, C. JR.
 DBA JET MACHINE WORKS COMPANY
 4519C WAYNE AVE
 PHILADELPHIA, PA 19144

J

CAGE code: 37KP5 1/

HEXAGON ENTERPRISES, INC.
 256 MINNESOTA AVENUE
 TROY, MI 48083

HI

CAGE code: 2/

HI INDUSTRIAL TECHNOLOGIES
 241 WOODLAND AVE
 MORTON , PA 19070



CAGE code: 0SS65 2/

HIGH QUALITY MACHINE SHOP
 2775 WALSH ROAD
 SAN ANTONIO, TX 78224

HQ

CAGE code: 0B011 2/

1/ Information published in this revision was verified by direct contact with manufacturers.

2/ Information not verified to be current, no response from manufacturer. Information identical to that published in MIL-HDBK-57, Revision B.

<p>HIGH TECH ENTERPRISES 3299 SAN FERNANDO RD. UNIT 11 LOS ANGELES, CA 90065</p> <p style="text-align: center; font-size: 2em;">HTE.</p> <p>CAGE code: 0TSH2 <u>2/</u></p>
<p>HIGHLAND PRODUCTS CORPORATION 9331 MERCANTILE DRIVE MENTOR, OH 44060-0452</p> <p style="text-align: center; font-size: 2em;">#P</p> <p>CAGE code: 0AKM4 <u>2/</u></p>
<p>HIGHLAND THREADS, INC. (FASTENER MANUFACTURING DIVISION) 708 E. TIDWELL HOUSTON, TX 77022-1822</p> <p style="text-align: center; font-size: 2em;">HT</p> <p>CAGE code: 1DT7C <u>2/</u></p>

<p>HILL AEROSPACE & DEFENSE LLC. 19734 DEARBORN STREET CHATSWORTH, CA 91311-6509</p> <p style="text-align: center; font-size: 2em;">HILL 1</p> <p>CAGE code: 55064 <u>2/</u></p>
<p>HILL FASTENER CORP. P.O. BOX 399 ROCK FALLS, IL 61071</p> <p style="text-align: center; font-size: 2em;">H HF</p> <p>CAGE code: 4R119 <u>1/</u></p>
<p>HILL STAMPING & MFG., INC. 3202 C STREET N.E. AUBURN, WA 98002-1789</p> <p style="text-align: center; font-size: 2em;">HS</p> <p>CAGE code: 7M611 <u>1/</u></p>

^{1/} Information published in this revision was verified by direct contact with manufacturers.

^{2/} Information not verified to be current, no response from manufacturer. Information identical to that published in MIL-HDBK-57, Revision B.

HILTI, INC.
5400 S. 122ND E. AVE
TULSA, OK 74121-6007

DX DIVISION

HILTI

H

ANCHOR DIVISION

HILTI
HEA M24 x 210
HILTI
HEA 3/4" x 6-5/8"

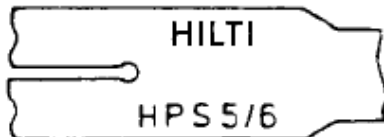
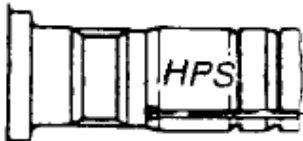

CAGE code: 11239

2/

HI-SHEAR CORP.
DBA FOREIGN PARENT IS LISI PARIS
FRANCE

See listing for LISI
2600 SKYPARK DRIVE
TORRANCE, CA 90505



hs HS

hs

Plant
TORONTO FASTENERS
INDUSTRIES, INC.
Subsidiary of Hi-Shear Corp., USA
19 CONSTELLATION COURT
REXDALE, ONTARIO M9W 1K4,
CANADA

F

CAGE code: 73197

1/

HLC INDUSTRIES INC.
6281 EMERALD LAKE DR
FARMINGTON HILLS, MI 48098

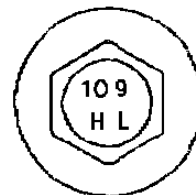





CAGE code: 0SC87

2/

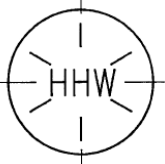
1/ Information published in this revision was verified by direct contact with manufacturers.

2/ Information not verified to be current, no response from manufacturer. Information identical to that published in MIL-HDBK-57, Revision B.

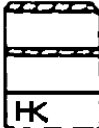
<p>HMS SERVICES LLC 10039 WOLFRIVER PLYMOUTH, MI 48170-4542</p> <p style="text-align: center;">M</p> <p style="text-align: center;">This is the headmarking for bolts and screws. Headmark appears on the top of head.</p> <p style="text-align: center;">M M M</p> <p style="text-align: center;">This marking is for nuts. This mark appears on the side of hex nuts.</p> <p>CAGE code: 1UYL6 2/</p>
<p>HO HONG WORKS CO., LTD 10 CHUNG SHAN ROAD LU CHU VILLAGE, KAOHSIUNG HSIEN, TAIWAN 821</p> <p style="text-align: center;"></p> <p>CAGE code: 1/</p>
<p>HOFFMANN, RICHARD GMBH CO. KG AM KIESWASSER 8-10 D-5940 LENNESTADT-ELSPE MEISELTER WEG KYLLEBURG, GERMANY 5524</p> <p style="text-align: center;">Plant HOFFMANN MACHINE COMPANY, INC. 1386 DREXEL ROAD VALDESE, NC 28690</p> <p style="text-align: center;">H</p> <p>CAGE code: 0HEK2 1/</p>

<p>HOLLYWOOD MANUFACTURING INC. 11915 VOSE STREET NORHT HOLLYWOOD, CA 91605-5750</p> <p style="text-align: center;">H</p> <p>CAGE code: 7T729 2/</p>
<p>HOLO-KROME CO. 31 BROOK STREET WEST HARTFORD, CT 06110-2385</p> <p style="text-align: center;">HK <i>On some socket screw products</i></p> <p style="text-align: center;"> <i>1960 series cap screws - old design</i></p> <p style="text-align: center;"> <i>1960 series cap screws - present design</i></p> <p style="text-align: center;"> <i>Metric socket cap</i></p> <p style="text-align: center;"> H-K  HK</p> <p>CAGE code: 74445 2/</p>
<p>HORSPPOOL & ROMINE MANUFACTURING CO., INC. 5850 MARSHALL STREET OAKLAND, CA 94608-2696</p> <p style="text-align: center;">HR HR</p> <p>CAGE code: 95723 1/</p>

1/ Information published in this revision was verified by direct contact with manufacturers.

2/ Information not verified to be current, no response from manufacturer. Information identical to that published in MIL-HDBK-57, Revision B.

HORST ENGINEERING &
MANUFACTURING CO.
P.O. BOX 280066
EAST HARTFORD, CT 06108-2003

Plant
36 CEDAR ST
EAST HARTFORD, CT 06108

HEM

HE HE

CAGE code: 05812 1/

HOUSTON FASTENER
(DIVISION OF WESTBROOK MFG)
1202 KRESS STREET
P.O. BOX 15614
HOUSTON, TX 77020

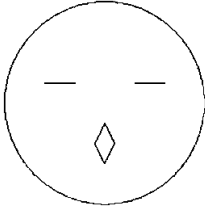

CAGE code: 0YN70 2/

HOUSTON PRECISION FASTENERS
10018 TANNER ROAD
HOUSTON, TX 77041

HPF

CAGE code: 1VSL7 1/

HOWARD TOOL CO., INC.
547 ODLIN ROAD
BANGOR, ME 04401-6707

HT

CAGE code: 044B0 2/

HOWE MACHINE AND TOOL CORP.
236 PARK AVE.
BETHPAGE, NY 11714-3709

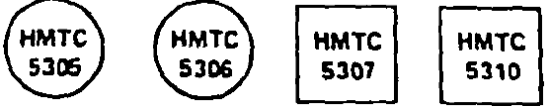

CAGE code: 65777 1/

HOWELL PRECISION, INC.
6 BROWN DRIVE
MOUND HOUSE, NV 89706-7744

HP

CAGE code: 6Y774 1/

HOWIE MANUFACTURING CO., INC.
P.O. BOX 426
COLLINGSWOOD, NJ 08108





Plant
1227 MECHANIC ST.
CAMDEN, NJ 08104-1221

hmc

CAGE code: 9V802 1/



1/ Information published in this revision was verified by direct contact with manufacturers.

2/ Information not verified to be current, no response from manufacturer. Information identical to that published in MIL-HDBK-57, Revision B.

<p>HUCK AEROSPACE PRODUCTS AFS CARSON OPERATIONS 900 WATSON CENTER ROAD CARSON, CA 90745-4201 CAGE code: 17446</p>  <p>AFS TUCSON OPERATIONS 3724 E. COLUMBIA ST. TUCSON, AZ 85714-3415 CAGE code: 0HDW7 (1G6U6 expired)</p>  <p>HUCK INDUSTRIAL PRODUCTS AFS WACO OPERATIONS 8001 IMPERIAL DRIVE WACO, TX 76714 CAGE code: 9K475</p>  <p>HUCK PRODUCTS AFS US OPERATIONS BP4, CLOS D'ASSEVILLE 95450 US PAR VIGNY FRANCE CAGE code: F6167</p> <p style="text-align: center;">H</p> <p>(Corporate office see ALCOA FASTENING SYSTEMS)</p> <p>CAGE code: 17446, 1G6U6, 9K475, F6167 1/</p>	<p>HUGGINS MFG. 4314 GARLAND DR. FORT WORTH, TX 76117</p> <p style="text-align: center;">H</p> <p>CAGE code: 0TCV6 2/</p> <hr/> <p>HUGO DURHOLT GMBH & CO. KG SCHRAUBENDREH-UND PREBWERK POSTFACH 16-80 D-5632 WERMELSKIRCHEN GERMANY</p>  <p>CAGE code: 1/</p> <hr/> <p>HUNT VALVE COMPANY, INC. DBA WAECO VALVE DIVISION 1913 EAST STATE STREET SALEM, OH 44460</p>  <p>CAGE code: 11859 2/</p> <hr/> <p>HUNTER STEVENS COMPANY 4003 FLEETWOOD AVE. FRANKLIN PARK, IL 60131</p> <p style="text-align: center;">HSC</p> <p>CAGE code: 48093 2/</p> <hr/> <p>HUNTINGTON VALLEY INDUSTRIES, INC DBA HVI 15182 TRITON LN 101 HUNTINGTON BEACH, CA 92649-1041</p> <p style="text-align: center;">HVI</p> <p>CAGE code: 9S754 2/</p>
--	---

1/ Information published in this revision was verified by direct contact with manufacturers.

2/ Information not verified to be current, no response from manufacturer. Information identical to that published in MIL-HDBK-57, Revision B.

<p>HURON AUTOMATIC SCREW CO. P.O. BOX 610068 4914 GRATIOT RD PORT HURON, MI 48061-0068</p> <p style="text-align: center;">H</p> <p>CAGE code: 00905 <u>2/</u></p>	<p>I.G.D. MACHINE & TOOL LTD. 992 HUBREY ROAD LONDON, ONTARIO, CANADA N6N 1B5</p> <p style="text-align: center;"></p> <p>CAGE code: <u>2/</u></p>
<p>HURRICANE MACHINE COMPANY, L.L.C. 2644 FREEWOOD DRIVE DALLAS, TX 75220</p> <p style="text-align: center;">9</p> <p>CAGE code: 1H7G3 <u>2/</u></p>	<p>IDEAL FASTENERS INC. 3850 E MIRALOMA AVE ANAHEIM, CA 92806</p> <p style="text-align: center;"></p> <p>CAGE code: 6F810 <u>1/</u></p>
<p>HYDRO FITTING MFG. CORP. 733 E. EDNA PLACE P.O. BOX 1558 COVINA, CA 91722-1409</p> <p style="text-align: center;">HF</p> <p>CAGE code: 13899 <u>2/</u></p>	<p>IFASTGROUPE 2004 LP CANADA</p> <p>SEE LISTINGS FOR:</p> <p>INFASCO 700 OUELLETTE MARIEVILLE, QUEBEC CANADA J3M 1P6 CAGE code: 1C225</p>
<p>HYDROBOLT LIMITED GLOBAL SERVICE CENTRE, MONMORE BUSINESS PARK, DIXON STREET WOLVERHAMPTON, WV2 2EE. U. K.</p> <p style="text-align: center;"> HB</p> <p>CAGE code: <u>1/</u></p>	<p>INFASCO NUT 3990 NASHUA DRIVE MISSISSAUGA, ONTARIO, CANADA L4VT 1P8 CAGE code: 06KL6</p> <p>INGERSOLL FASTENERS 390 THOMAS STREET INGERSOLL, ONTARIO CANADA N5C 3K3 CAGE code: 35571 <u>1/</u></p>

1/ Information published in this revision was verified by direct contact with manufacturers.

2/ Information not verified to be current, no response from manufacturer. Information identical to that published in MIL-HDBK-57, Revision B.

IMPERIAL SUPPLIERS, INC.
 P.O. BOX 11008
 789 PACKER DR
 GREEN BAY, WI 54304-4527

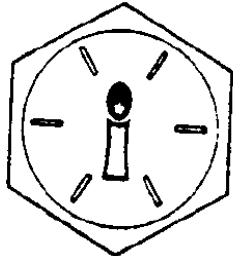

GRADE 8

CAGE code: 3A4R0

2/

INDIANA AIRCRAFT HARDWARE
 221 SOUTH MAIN STREET
 FORTVILLE, IN 46040-1514

IAH

CAGE code: 5N319

1/

INDUSTRIAL & AUTOMOTIVE FASTENERS
 (DIVISION OF KEY MANUFACTURING
 GROUP, INC.)
 3200 W. FOURTEEN MILE RD.
 ROYAL OAK, MI 48073

Inch Conelock Nuts

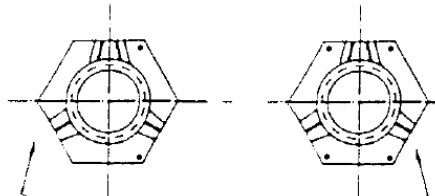

Company I.D.: 2 single & 1 double slash

Inch Wheelnut

Metric Wheelnut

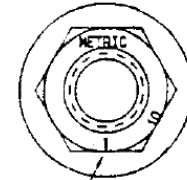
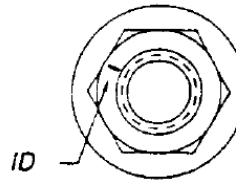

*Metric Flange Hex Nut
 company ID: 1*

Metric Conelock Nut

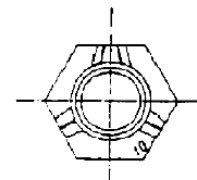
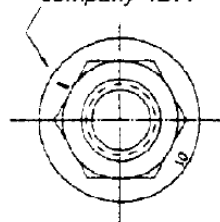

Company ID: 2 single & 1 double slash

Metric Capped Wheelnut

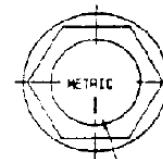

Company ID: 1

CAGE code:

2/

1/ Information published in this revision was verified by direct contact with manufacturers.

2/ Information not verified to be current, no response from manufacturer. Information identical to that published in MIL-HDBK-57, Revision B.

INDUSTRIAL FASTENERS CORP.
7 HARBOR PARK DR
PORT WASHINGTON, NY 11050

Raised or indented marks

Under head Top of head Slotted hexhead (top of head)

CAGE code: 84992 2/

INDUX, S.A. DE C.V.
LAMINADORA 37
BELLAVISTA-TACUBAYA
MEXICO, D.F. 01140
MEXICO

CAGE code: SDK76 1/

INDUSTRIAL FORGE, INC.
832 LANTANA RD
LAKE WORTH 33462 - 1509

CAGE code: 0RY28 2/

INFASCO
(see IFASTGROUPE 2004 LP)
700 OUELLETTE
MARIEVILLE, QUEBEC
CANADA
J3M 1P6

CAGE code: 1C225 1/

INDUSTRIAL NUT CORP.
1425 TIFFIN AVE
SANDUSKY, OH 44870-2054

or **INC**

Blue nylon insert identifies INC as manufacturer

Blue nylon insert identifies INC as manufacturer per IFI 514

2 equally spaced stakes identifies property Class 5 per IFI 514

3 equally spaced stakes identifies property Class 9 per IFI 514

4 equally spaced stakes identifies property Class 10 per IFI 514

6 equally spaced stakes plus notch in corner of hex identifies Grade C

6 equally spaced stakes identifies Grade B

INCH NYLON INSERT LOCKNUTS METRIC NYLON INSERT LOCKNUTS

The blue insert is a trademark of Industrial Nut Corp. registered in the U.S. Patent & Trade Office.

CAGE code: 81198 1/

INFASCO NUT
(see IFASTGROUPE 2004 LP)
3990 NASHUA DRIVE
MISSISSAUGA, ONTARIO,
CANADA
L4VT IPG8

CAGE code: 06KL6 1/

1/ Information published in this revision was verified by direct contact with manufacturers.

2/ Information not verified to be current, no response from manufacturer. Information identical to that published in MIL-HDBK-57, Revision B.

INGERSOLL FASTENERS
 (see IFASTGROUPE 2004 LP)
 390 THOMAS STREET
 INGERSOLL, ONTARIO
 CANADA
 N5C 3K3

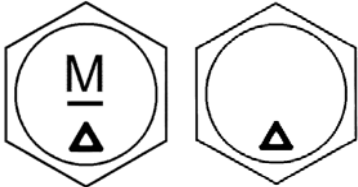

CAGE code: 35571 1/

INLAND MACHINE CO.
 10762 EDISON CT.
 RANCHO CUCAMONGA, CA 91730-4845



CAGE code: 6W617 2/

INOFAS^T MANUFACTURING INC.
 1370 INDUSTRY RD.
 HATFIELD, PA 19440



CAGE code: 2T359 2/

IN-SPECK CORP.
 208 EAST PENN ST
 NORRISTOWN, PA 19401-1471



CAGE code: 32904 2/

INSTRUMENT MACHINING SERVICE LTD.
 HOWLETT WAY, THETFORD,
 NORFOLK IP24 IHZ
 UNITED KINGDOM

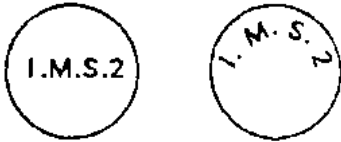

CAGE code: 2/

INTERFLEX MFG. CORP.
 144 TOLEDO ST
 FARMINGDALE, NY 75222-4429

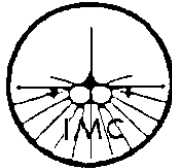

CAGE code: 0LD24 2/

INTERSTATE FITTINGS INC.
 2200 SINGLETON BLVD.
 DALLAS, TX 75212



CAGE code: 1EHF9 2/

IRVING MACHINE SERVICE, INC.
 451 MAIN STREET
 P.O. BOX 94
 IRVING, NY 14081



CAGE code: 2/

1/ Information published in this revision was verified by direct contact with manufacturers.

2/ Information not verified to be current, no response from manufacturer. Information identical to that published in MIL-HDBK-57, Revision B.

<p>IRWIN AUTOMATION, INC. 715 CLEVELAND STREET GREENSBURG, PA 15601-1279</p> <p style="text-align: center;">IRW</p> <p>CAGE code: 7H803 <u>1/</u></p>
<p>ISLAND ENGINEERING DBA J SMITH MACHINE SHOP INC 153 S MAIN ST FREEPORT, NY 11520-0384</p> <p style="text-align: center;"></p> <p>CAGE code: 40137 <u>2/</u></p>
<p>ITT HARPER AEROSPACE FASTENER OPERATIONS (AEROSPACE CONTROLS DIVISION) 28150 INDUSTRY DRIVE VALENCIA, CA 91355</p> <p style="text-align: center;">AOL</p> <p>CAGE code: <u>2/</u></p>

<p>ITW BUILDEX 1349 WEST BRYN MAWR AVE. ITASCA, IL 60143</p> <p style="text-align: center;">B X</p> <p>CAGE code: <u>2/</u></p>
<p>ITW CIP 2002 STEPHENSON HWY. TROY, MI 48083</p> <p style="text-align: center;">Plant ITW CIP CA 11525 S. SHOEMAKER AVE. SANTA FE SPRINGS, CA 90670</p> <p style="text-align: center;"></p> <p>CAGE code: Applied for <u>1/</u></p>

1/ Information published in this revision was verified by direct contact with manufacturers.



2/ Information not verified to be current, no response from manufacturer. Information identical to that published in MIL-HDBK-57, Revision B.

<p>IVACO INC. (See IFASTGROUPE 2004 LP, CANADA)</p> <p>See listings for:</p> <p>INFASCO 700 OUELLETTE MARIEVILLE, QUEBEC CANADA J3M 1P6 CAGE code: 1C225</p> <p>INFASCO NUT 3990 NASHUA DRIVE MISSISSAUGA, ONTARIO, CANADA L4VT IPG8 CAGE code: 06KL6</p> <p>INGERSOLL FASTENERS 390 THOMAS STREET INGERSOLL, ONTARIO CANADA N5C 3K3 CAGE code: 35571</p> <p>CAGE code: 1C225 <u>1/</u></p>
<p>J & M MACHINE INC. 1234 HIGH STREET PAINESVILLE, OH 44077</p> <p style="text-align: center;">1H423</p> <p>CAGE code: 1H423 <u>1/</u></p>
<p>J & S PRECISION PRODUCTS 16 EVESBORO RD. MEDFORD, NJ 08055-9592</p> <p style="text-align: center;">J — S</p> <p>CAGE code: 8B865 <u>2/</u></p>

<p>J. G. FASTENERS 9720 COZYCROFT AVE CHATSWORTH, CA 91311-4423</p> <p style="text-align: center;">JG</p> <p>CAGE code: 0VWM9 <u>2/</u></p>
<p>J. GEORG BIERBACH WERDOHLER STRASSE 23 ALTENA, GERMANY D-5990</p> <p style="text-align: center;">G E B I</p> <p style="text-align: center;"></p> <p>CAGE code: <u>2/</u></p>
<p>J.M. PRECISION, INC. (FASTENER DIVISION) 9722 TOPANGA CANYON BLVD CHATSWORTH, CA 913114015</p> <p style="text-align: center;">JP</p> <p>CAGE code: 0JV78 <u>1/</u></p>

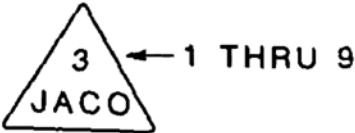

1/ Information published in this revision was verified by direct contact with manufacturers.



2/ Information not verified to be current, no response from manufacturer. Information identical to that published in MIL-HDBK-57, Revision B.

<p>J.P. PRODUCTS, INC. (DBA SPECIALITES, UNLIMITED) P.O. BOX 427 WILLOUGHBY, OH 44094</p> <p style="text-align: center;">S</p> <p>CAGE code: _____ <u>2/</u></p>	<p>JAMES JACKSON DBA J J ENGINEERING 11021 VIA EL MERCADO LOS ALAMITOS, CA 90720-0281</p> <p style="text-align: center;"></p> <p>CAGE code: 0CEP4 <u>2/</u></p>
<p>JACOBSON MFG., LLC. 941-955 LAKE RD. MEDINA, OH 44256</p> <p style="text-align: center;">Plant JACOBSON MFG – TIFFIN, LLC. 1988 COUNTY ROAD #593 TIFFIN, OH 44883</p> <p style="text-align: center;">J</p> <p>CAGE code: 58UV4 <u>1/</u></p>	<p>JAMISON INDUSTRIES INC. 12669 DELTA ST TAYLOR, MI 48180-6835</p> <p style="text-align: center;">Jl</p> <p>CAGE code: 1Z781 <u>1/</u></p>
<p>JACO ENGINEERING, INC. 879 SO. EAST STREET ANAHEIM, CA 92805-5356</p> <p style="text-align: center;"></p> <p>CAGE code: IH427 <u>1/</u></p>	<p>JAY BEE MACHINE WORKS, INC. 400 PIKE RD. HUNTINGDON VALLEY, PA 19006-1610</p> <p style="text-align: center;">B</p> <p>CAGE code: 74954 <u>1/</u></p>
<p>JAM TECH CORP. P.O. BOX 327 ESSINGTON, PA 19029</p> <p style="text-align: center;">Plant 1260 East Woodland Avenue Springfield, PA 19064</p> <p style="text-align: center;">JT</p> <p>CAGE code: IEM35 <u>2/</u></p>	<p>JAY O MACHINE CO., INC. 7685 HUB PARKWAY VALLEY VIEW, OH 44125-5706</p> <p style="text-align: center;"></p> <p>CAGE code: 5Z832 <u>2/</u></p>
	<p>JAYCO ENGINEERING, INC. 1660 BABCOCK AVENUE COSTA MESA, CA 92627-4330</p> <p style="text-align: center;"></p> <p>CAGE code: 7J578 <u>1/</u></p>

1/ Information published in this revision was verified by direct contact with manufacturers.

2/ Information not verified to be current, no response from manufacturer. Information identical to that published in MIL-HDBK-57, Revision B.

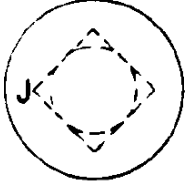
<p>JERGENS INC. DBA JERGENS INDUSTRIAL SUPPLY 15700 S WATERLOO RD CLEVELAND, OH 44110-3814</p>  <p>CAGE code: 94882 2/</p>
<p>JJ ENGINEERING (See JAMES JACKSON) 11021 VIA EL MERCADO LOS ALAMITOS, CA 90720-0281</p>  <p>CAGE code: 0CEP4 2/</p>
<p>JJ SCREW PRODUCTS, INC. 21519 PARTHENIA STREET CANOGA PARK, CA 91304</p>  <p>CAGE code: 75209 2/</p>
<p>JMT MACHINE COMPANY 9986 GANTRY ROAD PHILADELPHIA, PA 19115-1080</p> <p style="text-align: center; font-size: 2em;">2A832</p> <p>CAGE code: 2A832 2/</p>

<p>JOLICO/J-B TOOL INC. 4325 E. 22 MILE ROAD UTICA, MI 48317-1507</p> <p style="text-align: center; font-size: 2em;">JOLICO</p> <p>CAGE code: 19549 2/</p>
<p>JOSLYN CORP. MACLEAN POWER SYSTEMS 11411 ADDISON STREET FRANKLIN, IL 60131-1130</p> <p style="text-align: center;">Plant 3700 SOUTH MORGAN STREET CHICAGO, IL 60609-1461</p> <div style="display: flex; justify-content: space-around; align-items: center;"> <div style="text-align: center;">  <p>Machine bolts</p> </div> <div style="text-align: center;">  <p>Carriage bolts</p> </div> </div> <p>CAGE code: 74999 1/</p>
<p>JUPITER WASHERS, INC. 10-01 37TH AVE. LONG ISLAND CITY, NY 11101-6014</p>  <p>CAGE code: 25900 2/</p>

1/ Information published in this revision was verified by direct contact with manufacturers.

2/ Information not verified to be current, no response from manufacturer. Information identical to that published in MIL-HDBK-57, Revision B.

JUST IN TIME, INC.
 DBA APSCO
 2538 WEST LN., SUITE 16
 STOCKTON, CA 95205

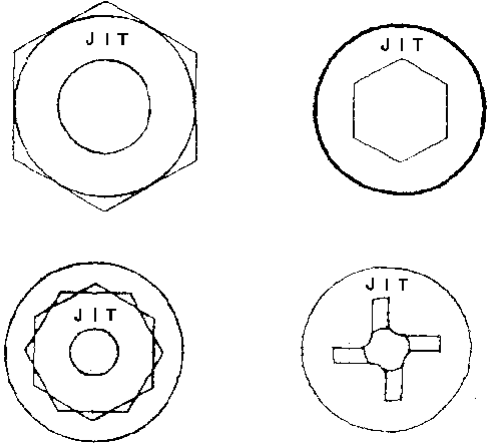

CAGE code: 0FVD5 2/

K & K PRECISION ENTERPRISES
 60 STEAM WHISTLE DRIVE
 WARMINSTER, PA 18974

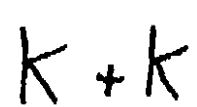

CAGE code: 1K6D9 2/

K.A.A. COMPANY
 (LYNN ABADIE DBA K A A COMPANY)
 1309 MADISON STREET
 WEATHERFORD, TX 76086-2144



CAGE code: 1XRQ5 2/

K.D.K. UPSET FORGING CO.
 2645 W. 139TH ST.
 P.O. BOX 146
 BLUE ISLAND, IL 60406-0146

KDK

CAGE code: 8P293 2/

KAMAX-WERKE RUDOLF KELLERMANN
 GmbH & CO. KG
 PETERSHUETTER ALLEE 29
 OSTRODE, GERMANY 37520

KAMAX
KX

CAGE code: C5315 2/

KAMAX L. P. (FORMERLY G.B. DUPONT
 CO., INC.)
 500 WEST LONG LAKE ROAD
 TROY, MI 48098-4540



CAGE code: 1DWW1 1/

KAMPWERK VIEREGGE U. PICKARDT
 GMBH. & CO
 P.O. BOX 5143
 PLETTENBURG 5 G-5970





CAGE code: 2/

1/ Information published in this revision was verified by direct contact with manufacturers.

2/ Information not verified to be current, no response from manufacturer. Information identical to that published in MIL-HDBK-57, Revision B.

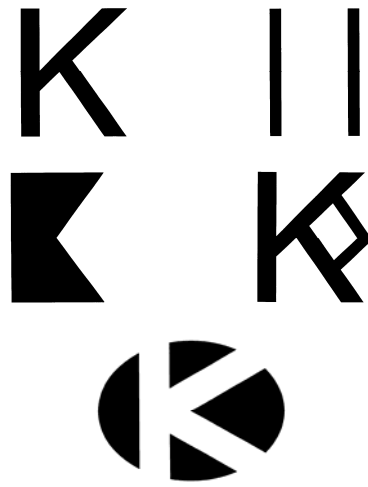
<p>KAPCO INDUSTRIES, INC. 5660 KNOTT AVE BUENS PARK, CA 90621</p>  <p>CAGE code: 0BMF4 2/</p>
<p>KATSURAGAWA MACHINE SCREW CO., LTD. 3-24-1 YAGUCHI OHTA-KU TOKYO 146 JAPAN</p> <p>Plant 366-1, KOGOSYO KAKEGAWA-SHI SHIZUOKA-KEN 436 JAPAN</p>  <p>CAGE code: 2/</p>
<p>KAYGOR, INC. 1243 TRANSIT STREET P.O. BOX 2950 POMONA, CA 91769-2950</p>  <p>CAGE code: 4H229 2/</p>

<p>KAYNAR PRODUCTS 800 S. STATE COLLEGE BLVD. FULLERTON, CA 92831</p> <p>(Corporate office see ALCOA FASTENING SYSTEMS)</p> <p>(Previously listed under MICRODOT INC.)</p>  <p>CAGE code: 15653 1/</p>
<p>KELLER ENGINEERING 136 W. 157TH STREET GARDENA, CA 90248-2226</p>  <p>CAGE code: 4W941 2/</p>
<p>KELOX/MICRODOT PRODUCTS AFS TORRANCE OPERATIONS 3020 WEST LOMITA BLVD. TORRANCE, CA 90505-5103</p> <p>(Corporate office see ALCOA FASTENING SYSTEMS)</p>  <p>CAGE code: 75237 1/</p>

1/ Information published in this revision was verified by direct contact with manufacturers.

2/ Information not verified to be current, no response from manufacturer. Information identical to that published in MIL-HDBK-57, Revision B.

KEN FORGING, INC.
 1049 GRIGGS RD
 P.O. BOX #277
 JEFFERSON, OH 44047

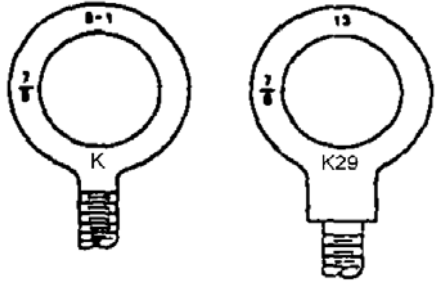

CAGE code: 1GMT9 1/

KEYSTONE BOLT & NUT COMPANY
 KEYSTONE THREADED PRODUCTS
 DIVISION
 P.O. BOX 31059
 CLEVELAND, OH 44313-0059

Plant
 7621 OLD ROCKSIDE RD.
 CLEVELAND, OH 44131-0059

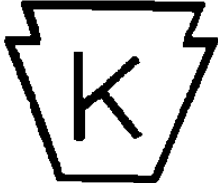

CAGE code: 4N487 1/

KERR, CHARLES W.
 RIVER RD BLDG PP-1
 JAY CEE INDUSTRIAL PK
 BRISTOL, PA 19007

see MAUI MEGA



CAGE code: 0M4F0 2/

KEYSTONE TOOL & MACHINE CO.
 108 N. McDADE BLVD.
 DARBY, PA 19023



CAGE code: 7Y516 2/

KERR LAKESIDE INC.
 26841 TUNGSTEN RD.
 P.O. BOX 32220
 EUCLID, OH 44117-2680



CAGE code: 7P576 1/



KILBOURN ENGINEERING CO.
 9226 WEST FLAGG AVE.
 MILWAUKEE, WI 53225-2718



CAGE code: 8H824 2/

1/ Information published in this revision was verified by direct contact with manufacturers.

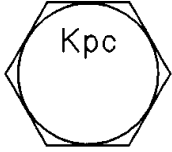

2/ Information not verified to be current, no response from manufacturer. Information identical to that published in MIL-HDBK-57, Revision B.

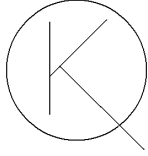
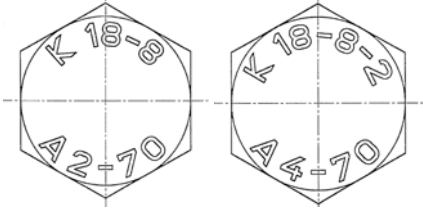
<p>KIRSTEN PIPE CO. INC. 1807 NW DOCK PL P.O. BOX 70526 SEATTLE, WA 98127-0526</p>  <p>CAGE code: 5E704 2/</p>
<p>K.L.M. MACHINE INC. 711 COLONIA LANE EAST NOKOMIS, FL 34275</p> <p style="text-align: center;">KLM</p> <p>CAGE code: 4NDJ6</p>
<p>KLINCHER LOCKNUT CORP. 2030 N. OXFORD ST. P.O. BOX 18100 INDIANAPOLIS, IN 46218</p> <p style="text-align: center;">KL</p> <p>CAGE code: 2/</p>
<p>KNIPPING-DORN GmbH KALTUMFORMTECHNIK 4690 HERNE 1 POSTFACH 1229 GERMANY</p>  <p style="font-size: small;">In connection with the identification mark of property class 3.6 up to and including 12.9</p> <p>CAGE code: 2/</p>

<p>KNOCH MANUFACTURING CO. LTD. 1054 SHAW RD DORCHESTER, CANADA N0L 1G4</p>  <p>CAGE code: 1C763 2/</p>
<p>KO AMS MACHINE PRODUCTS DBA KOAM MACHINE 915 BROOKS ST UNIT 102 ONTARIO, CA 91762-3603</p> <p style="text-align: center;">KO</p> <p>CAGE code: 0K7E0 2/</p>
<p>KOBE FASTENER LIMITED 654 HISBIE HIGASBI OSAKA, 577 JAPAN</p> <p style="text-align: center;"><i>α</i></p> <p>CAGE code: 2/</p>
<p>KOLB GMBH & CO. HERSTELLER VON VERBINDUNGSELEMENTEN RATHENAU STRASSE 23 POSTFACH 24 02 53 WUPPERTAL GERMANY 42277</p>  <p>CAGE code: D0472 2/</p>

1/ Information published in this revision was verified by direct contact with manufacturers.

2/ Information not verified to be current, no response from manufacturer. Information identical to that published in MIL-HDBK-57, Revision B.

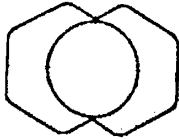
<p>KONDOR TECHNOLOGIES, INC. 206 CHRISTOPHER ST RONKONKOMA, NY 11779-6921</p> <p style="text-align: center;">KTI</p> <p>CAGE code: 06ZB0 <u>2/</u></p>	<p>KORODY COLYER CORP. A CR INDUSTRIES COMPANY 5412 MCFADDEN AVE. HUNTINGTON BEACH, CA 92649</p> <p style="text-align: center;">K</p> <p>CAGE code: 18954 <u>2/</u></p>
<p>KONGO BYORA CO., LTD. 2-1-27 SHITENNOJI TENNOJI-KU OSAKA 543 JAPAN</p> <p style="text-align: center;">Plant 3-31 NAGATA-NISHI HIGASHIOSAKA-SHI, OSAKA 577 JAPAN</p> <p style="text-align: center;"></p> <p>CAGE code: <u>2/</u></p>	<p>KOZAK, E. PERCISION PRODUCTS CO. 45 WOODLAND AVE. ROCKAWAY, NJ 07866</p> <p style="text-align: center;">KPP</p> <p>CAGE code: 1CP43 <u>2/</u></p>
<p>KOREA BOLT IND., CO., LTD. (FOREIGN TRADE DEPARTMENT) 620-34 GURO-DONG, GURO-KU SEOUL, KOREA</p> <p style="text-align: center;">Plant 732-3 WONSI-DONG, ANSAN-CITY GYUNGGI-DO, KOREA</p> <p style="text-align: center;"></p> <p>CAGE code: <u>2/</u></p>	<p>KPF 601 YOUNGTAN-DONG, CHUNGJU-CITY CHUNGCHEONGBUK-DO 380-250, KOREA</p> <p style="text-align: center;"></p> <p>CAGE code: <u>1/</u></p>
<p>KREIS TOOL & MFG., CO., INC. 1615 CAMBRIDGE DR ELGIN, IL 60123 - 3114</p> <p style="text-align: center;">KTM</p> <p>CAGE code: 64592 <u>2/</u></p>	

1/ Information published in this revision was verified by direct contact with manufacturers.

2/ Information not verified to be current, no response from manufacturer. Information identical to that published in MIL-HDBK-57, Revision B.

KROBACH MANUFACTURING CORP.
3504 ARDEN RD.
HAYWARD, CA 94545-5390



CAGE code: 30828 1/

KSS SOCKET SCREW, INC.
3416 S. 48TH STREET SUITE #6
PHOENIX, AZ 85040

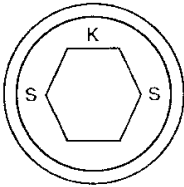

CAGE code: 0BMF5 2/

K-TECH MFG., INC.
288 HOLBROOK DRIVE
WHEELING, IL 60090

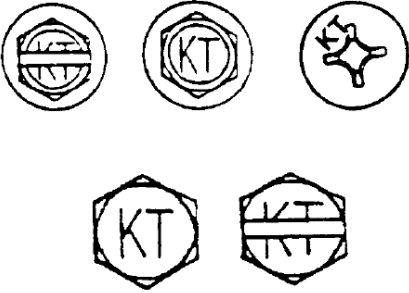

CAGE code: 2/

KYOEI SEISAKUSHO CO., LTD.
4-5-11 NUNOICHI-CHO
HIGASHIOSAKA-SHI,
OSAKA 579
JAPAN

Plant
MINAMISHINOZAKI
KAZSHI, SAILAMA-KEN
347 JAPAN



CAGE code: 2/

KYOKUTO MFG CO LTD.
3-5-29 WAKAEHONMACHI
HIGASHIOSAKA-SHI
OSAKA 578
JAPAN

Plant
1109-5 SHIBADE
KURAMOCHI-CHO,
NABARI-SHE, MIE-KEN 518-04
JAPAN



CAGE code: 2/

L & C MANUFACTURING CO., INC.
8610 S. 33RD W. AVENUE
TULSA, OK 74132-3403



CAGE code: 43813 2/

1/ Information published in this revision was verified by direct contact with manufacturers.

2/ Information not verified to be current, no response from manufacturer. Information identical to that published in MIL-HDBK-57, Revision B.

<p>L & H THREADED RODS CORP. DIV OF GRAY AMERICA CORP 3050 DRYDEN ROAD DAYTON, OH 45439</p> <p style="text-align: center;">L</p> <p>CAGE code: 0UH42 <u>2/</u></p>	<p>L H INDUSTRIES, INC. <i>TIP TOP TOOL CO.</i> 3513 NORTH 10th STREET PHILADELPHIA, PA 19140</p> <p style="text-align: center;">LH</p> <p>CAGE code: 0E7S8 <u>2/</u></p>
<p>L & J FASTENERS, INC. 3636 LACON ROAD HILLIARD, OH 43026-6122</p> <p style="text-align: center;"></p> <p>CAGE code: 1W358 <u>2/</u></p>	<p>L N AEROSPACE, INC. 6011 TENSION DRIVE FORT WORTH, TX 76112-2693</p> <p style="text-align: center;">LNA</p> <p>CAGE code: 1EB45 <u>2/</u></p>
<p>L & M ENTERPRISES, INC. 1910 NORTHERN WICHITA, KS 67216-2429</p> <p style="text-align: center;">L & M</p> <p>CAGE code: 0HDM5 <u>2/</u></p>	<p>L P R PRECISION PARTS AND TOOL COMPANY, INC. 108 ROME STREET FARMINGDALE, NY 11735-2136</p> <p style="text-align: center;">L. P. R.</p> <p>CAGE code: 31583 <u>2/</u></p>
<p>L. A. MARTIN CO. 14400 HENN STREET DEARBORN, MI 48126-1850</p> <p style="text-align: center;">LAM</p> <p>CAGE code: 9S775 <u>1/</u></p>	<p>L R G CORPORATION 210 MAGEE AVE JEANNETTE, PA 15644-2136</p> <p style="text-align: center;">LRG</p> <p>CAGE code: 75783 <u>2/</u></p>
<p>L G MACHINE & MFG INC. 1276 W. ARKANSAS LANE ARLINGTON, TX 76013-6235</p> <p style="text-align: center;">LG</p> <p>CAGE code: 0P4S2 <u>1/</u></p>	

^{1/} Information published in this revision was verified by direct contact with manufacturers.

^{2/} Information not verified to be current, no response from manufacturer. Information identical to that published in MIL-HDBK-57, Revision B.

LAKE ERIE SDREW CORP.
13001 ATHENS AVE.
LAKEWOOD, OH 44107-6201

LE



ASTM A 307



ASTM A 449



SAE J429 GR 5.1



SAE J429 GR 2



SAE J429 GR 5



ASTM A 354 BD ASTM F 568
CLASS 8.8

SAE J429 GR 6

SAE J429 GR 8

SAE J1199
CLASS 8.8



ASTM F 568
CLASS 9.8



ASTM F 568
CLASS 10.9



ASTM F 568
CLASS 12.9

SAE J1199
CLASS 9.8

SAE J1199
CLASS 10.9



ASTM A 325



ASTM A 325
TYPE 3
CLASS A



ASTM A 490



ASTM A 490
TYPE 3
CLASS A

CAGE code: 8B911

1/

LAMSON AND SESSIONS OF CANADA LTD.
RB & W CORP. METAL FORMING DIVISION
8341 TYLER BOULEVARD
MENTOR, OH 44060

MANUFACTURER NUTS – Sales Office
Lamson & Sessions of Canada Ltd.
Toronto Plant – Canada
5190 Bradco Boulevard
Mississauga, Ontario L4W 1G7
CANADA

STOVER[†] PREVAILING TORQUE LOCKNUTS



Grade A



Grade B



Grade C

Hex Automation – Imperial



Grade F



Grade G

Hex Flange – Imperial



Class 9

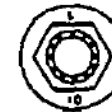

Class 10

Hex Flange – Metric





Hex Automation – Metric



CAGE code:

2/

1/ Information published in this revision was verified by direct contact with manufacturers.





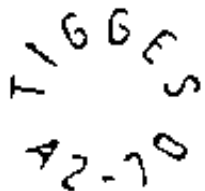





2/ Information not verified to be current, no response from manufacturer. Information identical to that published in MIL-HDBK-57, Revision B.

<p>LANA INDUSTRIES 4404-D MCLEAN DRIVE HALTOM CITY FORT WORTH, TX 76117</p> <p style="text-align: center;">LI</p> <p>CAGE code: <u>2/</u></p>
<p>LANARKSHIRE BOLT LTD. BURNBANK HAMILTON, LANARSHIRE ML3 OQU SCOTLAND</p> <p style="text-align: center;">L B </p> <p style="text-align: center;"><i>Raised letters</i></p> <p>CAGE code: K3565 <u>2/</u></p>
<p>LAND-SEA-AIR MACHINED PRODUCTS, INC. P.O. BOX H FLEMING PIKE WINSLOW, NJ 08095</p> <p style="text-align: center;">L-S-A</p> <p>CAGE code: 8U768 <u>2/</u></p>
<p>LANIS MACHINE & MFG., CO. 2506 S. COOPER #A-9 ARLINGTON, TX 76015-1608</p> <p style="text-align: center;"></p> <p>CAGE code: 8V177 <u>2/</u></p>

<p>LANUM METAL PRODUCTS, INC. 4100 N. 16TH STREET PHILADELPHIA, PA 19140-3008</p> <p style="text-align: center;"></p> <p style="text-align: center;">L.M.T.</p> <p>CAGE code: 0CY73 <u>2/</u></p>
<p>LBL PRODUCTS 5395 INDUSTRIAL DRIVE UNIT A HUNTINGTON BEACH, CA 92649-1516</p> <p style="text-align: center;"></p> <p>CAGE code: 1HJ06 <u>2/</u></p>
<p>LEBRECHT TIGGES GmbH & CO. KG P.O. BOX 12 04 85 W 5600 WUPPERTAL 12-CRONENBERG GERMANY</p> <p style="text-align: center;"></p> <p>CAGE code: <u>2/</u></p>

^{1/} Information published in this revision was verified by direct contact with manufacturers.

^{2/} Information not verified to be current, no response from manufacturer. Information identical to that published in MIL-HDBK-57, Revision B.

<p>LELAND-POWELL FASTENERS, INC. P.O. BOX 260 MARTIN, TN 38237</p> <p>Plant HIGHWAY 45 EAST SOUTH MARTIN, TN 38237</p>  <p>CAGE code: 2/</p>	<p>LEONARD JED CO MARYLAND BOLT AND NUT CO DIV (REPLACES MARYLAND BOLT & NUT CO., INC. -CAGE 76213) 1104 RUSSELL ST. BALTIMORE, MD 21230 - 2622</p>  <p>SAE J429 Grade 5 ASTM A449 MIL-B-857-A Grade 5</p> <p>NOTE: Also covers round head bolts, i.e., carriage-plow and countersunk styles, etc.</p>  <p>ASTM A193 Grade B-7 Alloy steel high temperature service bolting Tempered to 125 KSI tensile strength</p> <p>NOTE: Also covers sq. head and countersunk styles. Heavy head hex or regular configurations</p>
<p>LENCH, THOMAS WILLIAM, LTD. P.O. BOX 31 EXCELSIOR WORKS CARNEGIE ROAD, ROWLEY REGIS B65 8BZ UNITED KINGDOM</p>    <p>Raised letters Indented letters Raised or indented letters</p> <p>CAGE code: U0039 2/</p>	 <p>ASTM A490 Type 1</p> <p>NOTE: Also covers round head bolts, i.e., carriage-plow and countersunk styles, etc.</p>  <p>ASTM A394 Type T-0 Tower bolts: hex head, square head Head markings also include: T-1 for medium carbon and T-3 for weathering alloy steel. Both require heat treating</p> <p>NOTE: Round head step bolts require manufacturing head identification and proper markings as above, except length size</p>
<p>LENTERN (AIRCRAFT) LTD. MAIN RD, HAWKWELL, NR. HOCKLEY ESSEX SS5 4JJ GREAT BRITIAN, UK</p>  <p>CAGE code: 2/</p>	 <p>SAE J429 Grade 8 ASTM A354 Grade B0 Also (optional) that A354 is exhibited on top of head MIL-B-857-A Grade 8</p> <p>NOTE: Also covers round head bolts, i.e., carriage-plow and countersunk styles, etc.</p> <p>CAGE code: 52373 2/</p> <p>Continued</p>

1/ Information published in this revision was verified by direct contact with manufacturers.

2/ Information not verified to be current, no response from manufacturer. Information identical to that published in MIL-HDBK-57, Revision B.

Continued
LEONARD JED CO MARYLAND BOLT AND
NUT CO DIV



ASTM A325 Type 1
NOTE: Also covers round head bolts,
i.e., carriage-plow and countersunk
styles, etc.



With line under
A325 mark

ASTM A325 Type 3
NOTE: Also covers round head bolts,
i.e., carriage-plow and countersunk
styles, etc.



No Grade mark
— only manu-
facturer's
symbol

SAE J429 Grade 2
ASTM A307 Grades A & B
MIL-B-857-A Type 2 (ADM/5)
NOTE: Also covers round head bolts,
i.e., carriage-plow and countersunk
styles, etc.



With line under
A490 mark

ASTM A490 Type 3
NOTE: Also covers round head bolts,
i.e., carriage-plow and countersunk
styles, etc.



Letters B7M on
head

ASTM A193 Grade B-7-M
Alloy steel high temperature service
bolting
Tempered to 100 ksi tensile strength
NOTE: Also covers SQ head and
countersunk styles
Heavy head hex or regular configura-
tions



Heavy hex for
type C-3
Regular or
heavy for DH3

Manufacturer's symbol and the num-
ber 3 or DH3 on face
For Grade C-3 three radial lines are
also required
Heavy hex applications for C-3 and
heavy or regular for DH3
Nuts for bolt applications
ASTM A325 type 3
ASTM A563 Grade C-3
Also covers square nut configurations

CAGE code: 52373

2/

Continued

Continued
LEONARD JED CO MARYLAND BOLT AND
NUT CO DIV



Heavy or
regular

Manufacturer's symbol and the 2H or
DH marking
Also can be supplied in regular config-
urations
Suitable for all Grade B and A325 or
A490 bolts
Nuts for bolt applications
ASTM A194 Grade 2H
ASTM A563 Grade DH
Also covers square nut configurations



Heavy hex only

Manufacturer's symbol and three radial
lines
Heavy hex applications only
Nuts for bolt applications
ASTM A563 Grade C
For ASTM A325 bolts
Also covers square nut configurations

CAGE code: 52373

2/

LEVEL 1 FASTENERS
300 THIRD AVE
HUNTINGTON, WV 25701

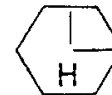

300 Series Stainless Steel

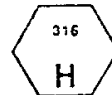

Type 316 Stainless Steel

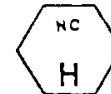
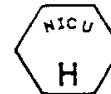

Nickel Copper (Monel)



BEK

CAGE code: 17283

1/

1/ Information published in this revision was verified by direct contact with manufacturers.

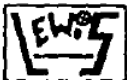
2/ Information not verified to be current, no response from manufacturer. Information identical to that published in MIL-HDBK-57, Revision B.

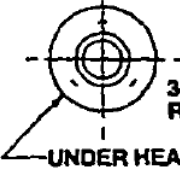
<p>LEVINGSTON MACHINE COMPANY 2428 MINNIS DR. HALTOM CITY, TX 76117-4856</p> <p style="text-align: center;">LM</p> <p>CAGE code: 46939 2/</p>
<p>LEWIS SREW COMPANY (DIV OF MEDALIST FASTENERS INC.) 2550 S 27TH AVE. BROADVIEW, IL 60155 - 3851</p> <div style="text-align: center;">  <p>LEWIS SCREW COMPANY <small>FASTENERS</small> THE FASTENER SPECIALIST</p> </div> <p style="text-align: center;">  120° INCLUDED ANGLE RAISED. </p> <p style="text-align: center;">INDENTED HEX HDS. AND INDENTED HEX WASHER HDS.</p> <div style="text-align: center;">  <p>LEWIS SCREW COMPANY <small>FASTENERS</small> THE FASTENER SPECIALIST</p> </div> <p style="text-align: center;">  3-DASH MARKS 120° APART RAISED </p> <p style="text-align: center;">UNDER HEAD UPON REQUEST "NON-COUNTERSUNK HEADS ONLY"</p> <p>CAGE code: 1AW87 2/</p>
<p>LFC INDUSTRIES INC. (DIVISION RKR TECHNOLOGIES) P. O. BOX 5982 1221 CORPORATE DRIVE WEST ARLINGTON, TX 76006-6103</p> <p style="text-align: center;">LFC</p> <p>CAGE code: 62384 1/</p>

<p>LINREAD NORTHBRIDGE LEICESTER, UK VIKING ROAD WIGSTON, LEICESTER ENGLAND LE18 2BL</p> <p style="text-align: center;">NB</p> <p>CAGE code: U6683 1/</p>
<p>LINREAD NORTHBRIDGE AIRCRAFT PRODUCT DIVISION CROSSGATE ROAD PARK FARM P.O. BOX 28 REDDITCH WORCESTERSHIRE B98 7TD UK</p> <div style="text-align: center;">  </div> <div style="text-align: center;">  </div> <p>CAGE code: K8753 2/</p>

1/ Information published in this revision was verified by direct contact with manufacturers.

2/ Information not verified to be current, no response from manufacturer. Information identical to that published in MIL-HDBK-57, Revision B.

LINREAD PUBLIC LIMITED CO.
 (AIRCRAFT PRODUCTS DIVISION)
 P.O. BOX 28, CROSSGATE ROAD
 PARK FARM INDUSTRIAL EST. REDDITCH,
 WORCESTERSHIRE B98 7TD
 UNITED KINGDOM

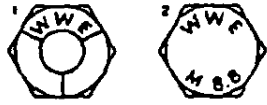

Illustration No.	Notes
1, 2	<p>Y = Unified S quality</p> <p>WWE = Linread Keeley St. (was Warne Wright Engineering and which no longer trades under that name)</p> <p>M = Metric screws and bolts</p> <p>88 or 8.8 = Grade 8.8. Alternative markings such as 109 or 10.9 may appear as appropriate.</p>

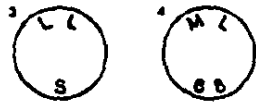

Illustration No.	Notes
3, 4	<p>LL or L = Linread Ltd</p> <p>S = Unified S quality. Alternative letters such as R and T may appear as appropriate.</p> <p>M = Metric screws and bolts</p> <p>88 or 8.8 = Grade 8.8. Alternative markings such as 109 or 10.9 may appear as appropriate.</p>

Illustration No.	Notes
3, 4. (Cont'd)	<p>↳ = Linread Plc</p>



CAGE code: K8753

Continued

2/

Continued

LINREAD PUBLIC LIMITED CO.
 (AIRCRAFT PRODUCTS DIVISION)
 P.O. BOX 28, CROSSGATE ROAD
 PARK FARM INDUSTRIAL EST. REDDITCH,
 WORCESTERSHIRE B98 7TD
 UNITED KINGDOM

Illustration No.	Notes
5, 6	<p>↳ = Linread Plc</p> <p>S = Unified S quality. Alternative letters such as R and T may appear as appropriate.</p> <p>M = Metric screws and bolts</p> <p>88 or 8.8 = Grade 8.8. Alternative markings such as 109 or 10.9 may appear as appropriate.</p>

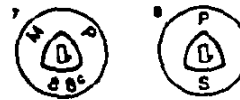

Illustration No.	Notes
7, 8	<p>△ = Trilobular screws and bolts. Various letters may appear, viz</p> <p>M = Metric. Absence of other letters indicate Duo-Taptite or Taptite parts.</p> <p>P = Powerlok</p> <p>C = Carbon restored surface, i.e., with no decarburization permitted but not case hardened.</p> <p>N = Neutral or through hardened</p> <p>I = Induction hardened lead threads</p> <p>S = Unified S quality. Alternative letters such as R and T may appear as appropriate.</p> <p>88 or 8.8 = Grade 8.8. Alternative markings such as 109 or 10.9 may appear as appropriate.</p>



CAGE code: K8753

2/

1/ Information published in this revision was verified by direct contact with manufacturers.

2/ Information not verified to be current, no response from manufacturer. Information identical to that published in MIL-HDBK-57, Revision B.

<p>LIPPISCHE EISENINDUSTRIE GmbH ALTER WEG 57 D-4930 GERMANY</p> <p style="text-align: center;">LE</p> <p>CAGE code: 2/</p>
<p>LISI AEROSPACE LISI AEROSPACE CANADA TOUR GAMMA A 193, RUE DE BERCY 75582 PARIS CEDEX 12 FRANCE</p> <p><i>Plant</i> A1 TECHNOLOGIES 7022 ALONDRA BLVD PARAMOUNT, CA 90723 3926</p> <p>NO SYMBOL LISTED</p> <p>CAGE code:</p> <p><i>Plant</i> LISI AEROSPACE CANADA 2000, PLACE TRANSCANADIENNE DORVAL (QUÉBEC) H9P 2K5 CANADA</p> <p style="text-align: center;">L</p> <p>CAGE code: L4528</p> <p>Continued 1/</p>

<p>Continued</p> <p>LISI AEROSPACE see BLANC AERO INDUSTRIES</p> <p><i>Plant</i> BLANC AERO INDUSTRIES VILLEFRANCHE DE ROUERGUE 18, RUE JEAN VAURS 12200 VILLEFRANCHE DE ROUERGUE FRANCE</p> <p style="text-align: center;">P </p> <p>CAGE code: F0188</p> <p><i>Plant</i> BLANC AERO INDUSTRIES RUGBY RUGBY WARWICKSHIRE CV21 3 RQ ENGLAND</p> <p style="text-align: center;">hs</p> <p>CAGE code: U6300</p> <p><i>Plant</i> BLANC AERO INDUSTRIES SAINT OUEN L'AUMONE 95310 SAINT OUEN L'AUMONE FRANCE</p> <p style="text-align: center;">T </p> <p style="text-align: center;"> <u>P</u> (Sr Briouc) B (Paris) P (Villefranche de Rouergue) ds. F </p> <p>CAGE code: F0188 1/</p> <p>Continued</p>

1/ Information published in this revision was verified by direct contact with manufacturers.

2/ Information not verified to be current, no response from manufacturer. Information identical to that published in MIL-HDBK-57, Revision B.

Continued

LISI AEROSPACE

Plant
BLANC AERO TECHNOLOGIES
B.P. 215
22002 SAINT BRIEUC CEDEX 1
FRANCE



CAGE code: F0188

Plant closed
DECOLLETAGE GENERAL MODERNE
DECOLLETAGE MODERNE 5 BIS, PLACE
LEON BLUM

DDG

Plant
FT BESTAS
35410 GAZIEMIR-IZMIR
TURKEY

BB
BBB

CAGE code: T0802

Plant
HI-SHEAR CORPORATION
see HI-SHEAR
260 SKYPARK DR.
TORRANCE, CA 90509-2975

HS hs
H h

CAGE code: 73197 1/
Continued

Continued

LISI AEROSPACE

Plant
MONADNOCK
18301 EAST ARENTH AVE.
CITY OF INDUSTRY, CA 91748-1288

• (a dot)

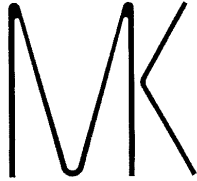
MONADNOCK

TMC

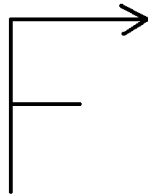

CAGE code: 60119 1/

1/ Information published in this revision was verified by direct contact with manufacturers.

2/ Information not verified to be current, no response from manufacturer. Information identical to that published in MIL-HDBK-57, Revision B.

LITTLE WORLD MANUFACTURING, INC.
1083 FOREST RD.
WEST CHESTER, PA 19380

Plant
525 WEST SOUTH STREET
KENNETT SQUARE, PA 19348

L<W>M

CAGE code: 6T569 2/

LLOYD MACHINE & TOOL CO., INC.
234 BROAD AVENUE
WILMINGTON, CA 90744-5812

LM

CAGE code: 01334 2/

LN AEROSPACE, INC.
6011 TENSION DRIVE
FORT WORTH, TX 76112-2693

LNA

CAGE code: 1EB45 2/

LOBO OFFICINE MECCANICHE SPA
VIA T. EDISON
CORANAREDO, MILANO ITALY 20010

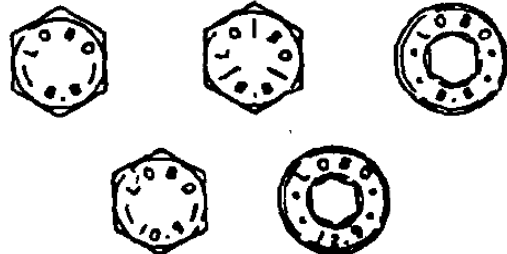

CAGE code: A1208 2/

LOBO SYSTEMS LTD
26 THE PARKER CENTRE
MANSFIELD ROAD
DERBY DE21 4SZ
ENGLAND

LOBO™

CAGE code: KE018 1/

LONE STAR FASTENERS, LP
(PREVIOUS LISTED AS LONE STAR
SCREW CO OF TEXAS INC
P.O. BOX 1149
SPRING, TX 77373

Plant
24131 HARDY ROAD
SPRING, TX 77373

L Precedes grade marking
(example: LB7)

CAGE code: 7H174 1/

LONG-LOK FASTENERS CORP.
10630 CHESTER RD
CINCINNATI, OH 45215-1206

Plant
14119 CHADRON AVE.
LOS ANGELES, CA 90250

CAGE code: 03038





LL or **LONG
LOK** or **LL**

CAGE code: 16941, plant 03038 1/

1/ Information published in this revision was verified by direct contact with manufacturers.

2/ Information not verified to be current, no response from manufacturer. Information identical to that published in MIL-HDBK-57, Revision B.

<p>LOOS & CO., INC. AEROSPACE FASTENERS DIVISION ROUTE 101 POMFRERT, CT 06258-0098</p>  <p>CAGE code: 59157 <u>1/</u></p>
<p>LORD CORPORATION AEROSPACE PRODUCTS DIVISION 1635 WEST 12TH STREET P.O. BOX 3694 ERIE, PA 16508 – 0694</p> <p>CAGE code: 0PJN4</p>  <p>Plant MECHANICAL PRODUCTS DIVISION 4644 WADSWORTH RD. DAYTON, OH 45414 – 4220</p> <p>CAGE code: 30061</p>  <p>CAGE code: 0PJN4, 30061 <u>2/</u></p>
<p>LOUGHLIN MANUFACTURING CORP. 1580 RAILROAD AVE HOLBROOK, N.Y. 11741-2301</p>  <p>CAGE code: 65782 <u>1/</u></p>

<p>M & M MANUFACTURING CORPORATION 5611 KIMBALL CT CHINO , CA 91710</p>  <p>CAGE code: 0X598 <u>2/</u></p>
<p>M.A.A. CORP, MID AMERICA AEROSPACE DIVISION 16201 WEST 110TH STREET SHAWNEE MISSION, KS 66285</p>  <p>CAGE code: <u>2/</u></p>
<p>M.L.W. MANUFACTURING CO. P.O. BOX 8445 NEW HAVEN, CT 06511</p> <p>Plant 240 SARGENT DRIVE NEW HAVEN, CT 06511</p>  <p>CAGE code: 0GH69 <u>2/</u></p>
<p>M.S. AEROSPACE 3150 DAMON WAY SYLMAR, CA 91342-1005</p>  <p>CAGE code: OUCY9 <u>1/</u></p>

1/ Information published in this revision was verified by direct contact with manufacturers.

2/ Information not verified to be current, no response from manufacturer. Information identical to that published in MIL-HDBK-57, Revision B.

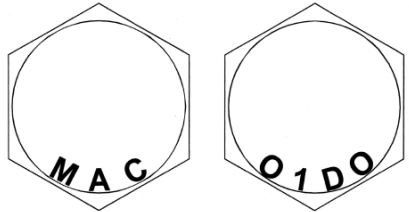
<p>MAC FASTENERS, INC. 11110 ENTERPRISE ST. OTTAWA, KS 66067-3803</p>  <p>GOTHIC LETTERS "MAC" GOTHIC LETTERS AND NUMERAL "O1DO"</p> <p>CAGE code: ORFT4 1/</p>
<p>MACHINE SHOP, INC., THE 470 AIR PARK RD ATWATER, CA 95301</p> <p style="text-align: center; font-size: 2em;">TMS</p> <p>CAGE code: 8T052 2/</p>
<p>MACHINERITE CORP. SYCAMORE & MILL RDS. CLIFTON HTS, PA 19018</p> <p style="text-align: center; font-size: 2em;">MR</p> <p>CAGE code: 7J299 2/</p>

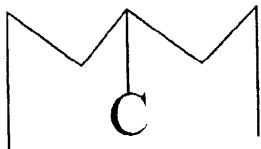
<p>MACK, A. W. MFG CO. 516 DUTCHESS TURNPIKE POUGHKEEPSIE, NY 12603</p>  <p>CAGE code: 32448 2/</p>
<p>MACKO INDUSTRIES HWY 39 AT FM RD. 1340 P.O. BOX 170 HUNT, TX 78024-0170</p> <p style="text-align: center; font-size: 3em;">M</p> <p>CAGE code: 1CN43 2/</p>
<p>MACKSON MFG CORP. 2338 SOUTHWAY DRIVE ROCK HILL, SC 29730</p>  <p>CAGE code: 093Y9 2/</p>

1/ Information published in this revision was verified by direct contact with manufacturers.

2/ Information not verified to be current, no response from manufacturer. Information identical to that published in MIL-HDBK-57, Revision B.

MACLEAN-ESNA
 (formally Elastic Stop Nut)
 611 COUNTRY CLUB RD.
 POCAHONTAS, AR 72455

E

EN

ESNA

RED NYLON INSERT INDICATES
 MACLEAN-ESNA AS
 MANUFACTURER

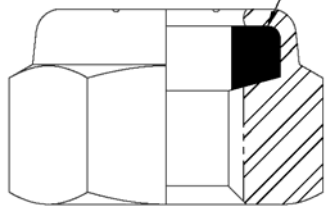

CAGE code: 019L2

1/

MACLEAN-FOGG CO.
 2551 WACKER RD.
 SAVANNA, IL 61074

*Flange nuts less lock and with
 Uni-Torque® lock
 Two raised bars*

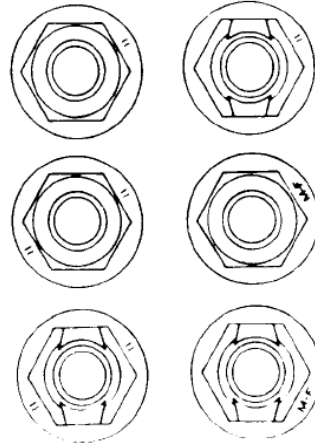

Hex and flange screws/bolts

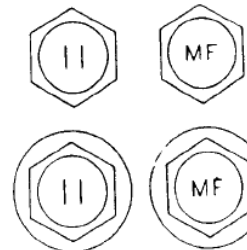

Hex nuts and Uni-Torque® locknuts

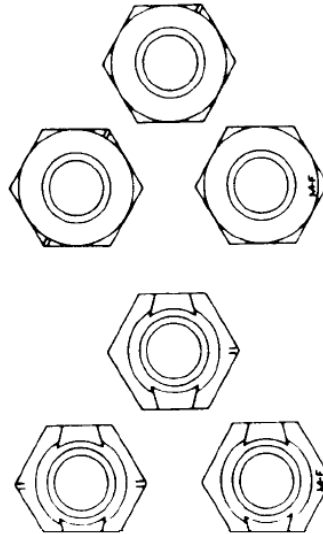



CAGE code: 0AMX8

2/

1/ Information published in this revision was verified by direct contact with manufacturers.





2/ Information not verified to be current, no response from manufacturer. Information identical to that published in MIL-HDBK-57, Revision B.

<p>MACOR, INC. 130 HOFFMAN LN CENTRAL ISLIP, NY 11722</p>  <p>CAGE code: 2A269 <u>2/</u></p>
<p>MAGNUM MACHINE SHOP 768 HOMEWARD PL SAN JOSE, CA 95123-2906</p> <p style="text-align: center;">1YFG0</p> <p>CAGE code: 1YFG0 <u>2/</u></p>
<p>MAGNUS TOOL & DIE CO., INC. 256 SHEFFIELD ST. MOUNTAINSIDE, NJ 07092</p>  <p>CAGE code: 37752 <u>2/</u></p>
<p>MAILLY MFG CO., INC. P. O. BOX 6143 45 WAKELEE ROAD WOLCOTT, CT 06716-2620</p>  <p>CAGE code: 3L606 <u>1/</u></p>

<p>MAIN MACHINE CO INC. DBA MAIN MACHINE & TOOL CO 116 MARINE STREET FARMINGDALE, NY 11735-5608</p> <p style="text-align: center;">MMT</p> <p>CAGE code: 05879 <u>1/</u></p>
<p>MANNO, RICHARD & CO., INC. 42 LAMAR ST NORTH BABYLON, NY 11704</p> <p style="text-align: center;">R/M</p> <p>CAGE code: 0RGV4 <u>2/</u></p>
<p>MANUFACTURING ENGINEERING TECH. 2758 AIELLO DR. SAN JOSE, CA 95111-2134</p>  <p>CAGE code: 1CC57 <u>2/</u></p>
<p>MANUFACTURING SALES AND SERVICE 10631 BLOOMFIELD AVE #16 LOS ALAMITOS, CA 90720</p>  <p>CAGE code: 1S9V3 <u>2/</u></p>

1/ Information published in this revision was verified by direct contact with manufacturers.

2/ Information not verified to be current, no response from manufacturer. Information identical to that published in MIL-HDBK-57, Revision B.

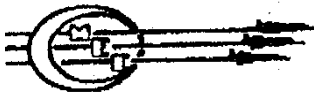
<p>MANUFACTURING TECHNOLOGY SERVICES 111 CLINTON ROAD FAIRFIELD, NJ 07004</p>  <p>CAGE code: 4WCW0 <u>1/</u></p>	<p>MARTIN-CHANDLER, INC. 122 EAST ALONDRA BOULEVARD GARDENA, CA 902</p>  <p>CAGE code: 22625 <u>2/</u></p>
<p>MAPECO PRODUCTS, INC. 725 GLEN GLOVE AVE. P.O. BOX 6 GLEN HEAD, NY 11545</p>  <p>CAGE code: 4P839 <u>2/</u></p>	<p>MARUYKO NUT CO., LTD. 2-4-15 NAKANO-CHO, HIGASHI TONDABAYASHI-SHI OSAKA 584 JAPAN</p>  <p>CAGE code: <u>2/</u></p>
<p>MAR-BRO MFG., INC. 5717 W. WASHINGTON STREET PHOENIX, AZ 85043-3650</p>  <p>CAGE code: <u>2/</u></p>	<p>MARVIN ENGINEERING, CO., INC. 260 WEST BEACH AVENUE INGLEWOOD, CA 90302-2903</p>  <p>CAGE code: 32067 <u>2/</u></p>

1/ Information published in this revision was verified by direct contact with manufacturers.

2/ Information not verified to be current, no response from manufacturer. Information identical to that published in MIL-HDBK-57, Revision B.

MARYLAND BOLT & NUT CO., INC.
 LEONARD JED CO
 1104 RUSSELL ST.
 BALTIMORE, MD 21230-2622



SAE J429 Grade 5
ASTM A448
MIL-B-857-A Grade 5

NOTE: Also covers round head bolts, i.e., carriage-plow and countersunk styles, etc.



ASTM A193 Grade B-7
 Alloy steel high temperature service bolting
 Tempered to 125 KSI tensile strength

NOTE: Also covers sq. head and countersunk styles.
 Heavy head hex or regular configurations



ASTM A490 Type 1

NOTE: Also covers round head bolts, i.e., carriage-plow and countersunk styles, etc.



ASTM A394 Type T-0
 Tower bolts: hex head, square head
 Head markings also include: T-1 for medium carbon and T-3 for weathering alloy steel. Both require heat treating

NOTE: Round head step bolts require manufacturing head identification and proper markings as above, except length size

CAGE code: 76213(canceled)
 Replaced by 52373 2/

Continued

Continued

MARYLAND BOLT & NUT CO., INC.



SAE J429 Grade 8
ASTM A354 Grade BD

Also (optional) that A354 is exhibited on top of head
MIL-B-857-A Grade 8

NOTE: Also covers round head bolts, i.e., carriage-plow and countersunk styles, etc.



ASTM A325 Type 1

NOTE: Also covers round head bolts, i.e., carriage-plow and countersunk styles, etc.



ASTM A325 Type 3

NOTE: Also covers round head bolts, i.e., carriage-plow and countersunk styles, etc.

With line under A325 mark



SAE J429 Grade 2
ASTM A307 Grades A & B
MIL-B-857-A Type 2 (ADM/5)

NOTE: Also covers round head bolts, i.e., carriage-plow and countersunk styles, etc.

No Grade mark - only manufacturer's symbol



ASTM A490 Type 3

NOTE: Also covers round head bolts, i.e., carriage-plow and countersunk styles, etc.

With line under A490 mark



ASTM A193 Grade B-7-M
 Alloy steel high temperature service bolting
 Tempered to 100 ksi tensile strength

NOTE: Also covers SQ head and countersunk styles
 Heavy head hex or regular configurations

Letters B7M on head

CAGE code: 76213(canceled)
 Replaced by 52373 2/

Continued

1/ Information published in this revision was verified by direct contact with manufacturers.

2/ Information not verified to be current, no response from manufacturer. Information identical to that published in MIL-HDBK-57, Revision B.

Continued

MARYLAND BOLT & NUT CO., INC.



Manufacturer's symbol and the number 3 or DH3 on face

For Grade C-3 three radial lines are also required

Heavy hex applications for C-3 and heavy or regular for DH3

Nuts for bolt applications

ASTM A325 type 3

ASTM A563 Grade DH3

Also covers square nut configurations

Heavy hex for type C-3

Regular or heavy for DH3

CAGE code: 76213(canceled)
Replaced by 52373 2/



Manufacturer's symbol and the 2H or DH marking

Also can be supplied in regular configurations

Suitable for all Grade 8 and A325 or A490 bolts

Nuts for bolt applications

ASTM A194 Grade 2H

ASTM A563 Grade DH

Also covers square nut configurations

Heavy or regular



Manufacturer's symbol and three radial lines

Heavy hex applications only

Nuts for bolt applications

ASTM A563 Grade C

Heavy hex only For ASTM A325 bolts

Also covers square nut configurations

MASTER RESEARCH & MFG., INC.

13528 PUMICE ST
NORWALK, CA 90650 - 5249



CAGE code: 9U245 2/

MASTERCRAFT TOOL COMPANY
13743 SHORELINE CT E
EARTH CITY, MO 63045 - 1202



CAGE code: 2M351 2/

MAUDLE INDUSTRIAL CO., LTD.
1-20 TSAO HU ROAD
TALI CITY, TAIWAN 41245



CAGE code: SH978 2/

MAUI MEGA
DBA KERR CHARLES W
JAY-CEE INDUSTRIAL PARK
RIVER RD. BLDG. PP-1
BRISTOL, PA 19007

see KERR CHARLES W



CAGE code: 0M4F0 2/

MCADAMS MACHINE AND TOOL CO.
2853 E FLORENCE AVE
HUNTINGTON PARK, CA 90255



CAGE code: 0UUE2 2/

1/ Information published in this revision was verified by direct contact with manufacturers.

2/ Information not verified to be current, no response from manufacturer. Information identical to that published in MIL-HDBK-57, Revision B.

MCCULLOUGH AERO CO.
 DBA MCCULLOUGH & ASSOCIATES
 23891 MADISON STREET
 TORRANCE, CA 90505-6008



CAGE code: 04273 2/

MD3 INDUSTRIES LTD
 108 W HOLLOWAY DR
 HURST, TX 76053 - 6807

See EMPIRE PRECISION MACHINING



CAGE code: 1/

MCLANE MFG INC.
 P. O. BOX 438
 7210 ROSECRANS AVE.
 PARAMOUNT, CA 90723 - 0438



CAGE code: 52706 2/

MEACO PRODUCTS CORP.
 99 PECK HILL ROAD
 JOHNSTON, RI 02919-4510

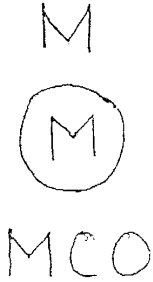

CAGE code: 032Z0 2/

McMELLON BROS INC.
 915 HONEYSPOT RD.
 STRATFORD, CT 06615 - 7192

05141

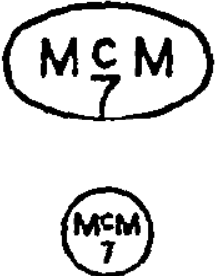

CAGE code: 05141 1/

MEC WOLF SRL
 VIA MILANO, 5
 22036 ERBA (CO) ITALY



The lot identification "xy" (letter + numb.) is embossed on the ring.





The manufacturer's mark "W" is embossed on the crown.

CAGE code: 2/

1/ Information published in this revision was verified by direct contact with manufacturers.

2/ Information not verified to be current, no response from manufacturer. Information identical to that published in MIL-HDBK-57, Revision B.





<p>MECAERO PRODUCTS AFS TOULOUSE OPERATIONS BD DU GRAND CASTING ROQUES-SUR-GARONNE 31128 PORTET SUR GARONNE CEDEX FRANCE</p> <p>(Corporate office see ALCOA FASTENING SYSTEMS)</p>  <p style="font-size: 2em; font-weight: bold; margin-left: 200px;">M</p> <p>CAGE code: F7411 1/</p>
<p>MECAERO CANADA INC. 2250 COHEN VILLE ST-LAURENT QUEBEC, H4R 9Z7 CANADA</p>  <p>CAGE code: 2/</p>
<p>MECAIR AEROSPACE INDUSTRIES SUBSIDIARY OF SPS TECHNOLOGIES DIV DIVISION OF SPS TECHNOLOGIES DBA MECAIR INC 225 LABROSSE PT. CLAIRE, CANADA H9R 1A3</p>  <p>CAGE code: 0HL40 2/</p>

<p>MECHANICAL & INDUSTRIAL FASTENERS 1145 JANSEN FARM DRIVE ELGIN, IL 60123</p>    <p>CAGE code: 0P8N1 2/</p>
<p>MECHANICAL INDUSTRIES LLC 8900 NORTH 51ST STREET MILWAUKEE, WISCONSIN 53223-2402</p>  <p>CAGE code: 1U732 2/</p>
<p>MEL-BA MANUFACTURING INC. 777 SUGAR LN ELYRIA , OH 44035 - 5631</p>  <p>CAGE code: 3A092 2/</p>

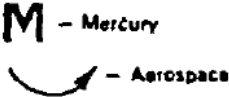
1/ Information published in this revision was verified by direct contact with manufacturers.

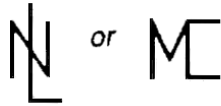

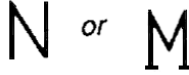

2/ Information not verified to be current, no response from manufacturer. Information identical to that published in MIL-HDBK-57, Revision B.

<p>MERCER PRODUCTS & MFG. CO., INC. 401 S. WEBSTER STREET SEATTLE, WA 98108 - 4137</p> <p style="text-align: center;"><u>MP</u></p> <p>CAGE code: 30205 1/</p>
<p>MERCURY AREOSPACE INC. 20320 PRARIE STREET CHATSWORTH, CA 91313</p> <p style="text-align: center;">  M - Mercury  - Aerospace </p> <p>CAGE code: 50945 2/</p>
<p>MERCURY TOOL & MACHINE, INC. P.O. BOX 5190 WACO, TX 76708-5190</p> <p style="text-align: center;">Plant AIRPORT DRIVE & ZOO PARK DR. WACO, TX 76708-5190</p> <p style="text-align: center;">MTM</p> <p>CAGE code: 01982 2/</p>

<p>METALCRAFTERS (DIVISION OF KEYSTONE CONSOLIDATED INDUSTRIES) 4500 KISHWAUKEE STREET P.O. BOX 7005 ROCKFORD, IL 61125-7005</p> <p style="text-align: center;">  or  <i>Indented hex & hex washer heads</i> </p> <p style="text-align: center;">  or  <i>Hex cap screws - low carbon steel</i> </p> <p style="text-align: center;">  <i>Mis. markings for screws & bolts</i> </p> <p>CAGE code: 2/</p>
<p>METAL-TECH MFG. INC. 1445 SOUTH 18TH ST. CLINTON, IA 52732-6703</p> <p style="text-align: center;">MT</p> <p>CAGE code: 3BNL5 1/</p>
<p>METHODS AND MACHINING SERVICES CO. 140 UXBRIDGE ST CRANSTON, RI 02920-4811</p> <p style="text-align: center;">MMS</p> <p>CAGE code: 0FYD8 2/</p>

1/ Information published in this revision was verified by direct contact with manufacturers.

2/ Information not verified to be current, no response from manufacturer. Information identical to that published in MIL-HDBK-57, Revision B.



<p>METRO TOOL & MANUFACTURING CO. ALSO SEE ALEXANDER MANUFACTURING COMPANY INC 2402 ARKANSAS LANE GRAND PRAIRIE, TX 75052-7203</p> <p style="text-align: center;"></p> <p>CAGE code: 2M919 1/</p>
<p>METRIX MFG. CO. 840 BRITTAN AVE. SAN CARLOS, CA 94070-4181</p> <p style="text-align: center;"> METRI METRIX</p> <p>CAGE code: 2/</p>
<p>MI. ME. AF. S.r.l. C.so EUROPA, 240 24032 CALOZIOCORTE (BG) ITALY</p> <p style="text-align: center;"></p> <p>CAGE code: 2/</p>
<p>MICRO SCREW MACHINE PRODUCTS, INC. 71 ROOSEVELT AVE CARTERET , NJ 07008</p> <p style="text-align: center;"></p> <p>CAGE code: 43808 2/</p>

<p>MICRODOT INC. MICRODOT AEROSPACE FASTENING SYSTEMS GROUP ADVANCED PRODUCTS DIV 190 W CROWTHER AVE PLACENTIA, CA 92670 - 5687</p> <p style="text-align: center;"></p>
<p>KAYNAR TECHNOLOGIES INC MICRODOT DIV 800 SOUTH STATE COLLEGE BOULEVARD P.O. BOX 3001 PLACENTIA, CA 92670 - 5687 CAGE code: 1EJY4</p> <p>(SEE KAYNAR PRODUCTS CAGE code: 15653)</p> <p style="text-align: center;"></p> <p><i>Used on sheet metal or stamped products.</i></p> <p style="text-align: center;"></p> <p><i>Used on forged or foreign products</i></p> <p style="text-align: center;"></p> <p><i>Two parallel lines used on Spirallock® products only</i></p> <p style="text-align: center;"></p> <p><i>Used on metric products</i></p> <p style="text-align: center;"></p> <p><i>Used on miscellaneous and general Kaynar products</i></p>
<p>MICRODOT INSERTS DEVISION 10 S. LA SALLE STREET SUITE 3500 CHICAGO, IL 60603 CAGE code: 51204</p> <p style="text-align: center;"> </p> <p><i>Three parallel lines spiralok insert products only</i></p> <p>CAGE code: 0BPE9 2/</p>

1/ Information published in this revision was verified by direct contact with manufacturers.

2/ Information not verified to be current, no response from manufacturer. Information identical to that published in MIL-HDBK-57, Revision B.

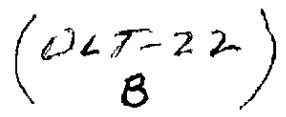
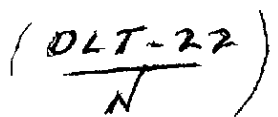
<p>MID CONTINENT SCREW PRODUCTS CO. 3701 WEST LUNT AVE. LINCOLNWOOD, IL 60712</p> <p> </p> <p>CAGE code: 1QMD3 <u>2/</u></p>
<p>MID-STATES SCREW CORP. (ILLINOIS CORPORATION) 1817 EIGHTEENTH AVENUE ROCKFORD, IL 61101</p> <p></p> <p>CAGE code: 17264 <u>2/</u></p>
<p>MIDWEST ACORN NUT CO. 256 MINNESOTA AVE. TROY, MI 48083</p> <p></p> <p>CAGE code: 98960 <u>2/</u></p>
<p>MILE-HI MACHINE, INC. 6395 WEST 56TH AVE. ARVADA, CO 80002</p> <p></p> <p>CAGE code: 1M949 <u>1/</u></p>

<p>MILLIPART, INC. 412 W. CARTER DRIVE GLENORA, CA 91740-5968</p> <p></p> <p>CAGE code: 31095 <u>2/</u></p>
<p>MILLS, J. R. MACHINING, INC 815 McCORD HOLLOW ROAD HOHENWALD, LEWIS, TN 38462</p> <p> <i>N N</i> </p> <p>CAGE code: 0LT22 <u>2/</u></p>
<p>MIL-SPEC FASTENERS CORP. 314 HANOVER PIKE HAMPSTEAD, MD 21074-9999</p> <p></p> <p>CAGE code: 356S3 <u>2/</u></p>

1/ Information published in this revision was verified by direct contact with manufacturers.

2/ Information not verified to be current, no response from manufacturer. Information identical to that published in MIL-HDBK-57, Revision B.

MINEBEA CO. LTD
 FUJISAWA MANUFACTURING UNIT
 1-1-1 KATASE, FUJISAWA CITY
 KANAGAWA 251-8531
 JAPAN



Trademark, Takyo Rashi

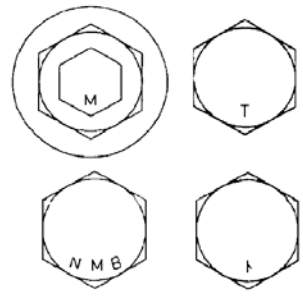

CAGE code: SB962 1/

MIROFINE COMPANY
 1940 W. 144TH STREET
 GARDENA, CA 90249-2928

MFR 1L071

CAGE code: 1L071 2/

MI-TECH, INC.
 6685 JET PARK DRIVE
 N. CHARLESTON, SC 29406-4700

MI-TECH, INC.

CAGE code: 9J758 2/

MITSUBOSHI INDUSTRIES, LTD.
 (OSAKA DIVISION)
 4-16-1 CHOME, MIDORIGI
 SUMINOE-KU, OSAKA 559
 JAPAN

N

NK

NKYM

CAGE code: 2/

MIX TOOL CO.
 212 E. CEDAR STREET
 COMPTON, CA 90220





CAGE code: 27643 2/

1/ Information published in this revision was verified by direct contact with manufacturers.

2/ Information not verified to be current, no response from manufacturer. Information identical to that published in MIL-HDBK-57, Revision B.

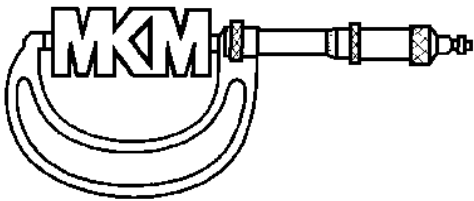
MKM MACHINE TOOL COMPANY INC.
 100 TECHNOLOGY WAY
 JEFFERSONVILLE, IN 47130-9644



CAGE code: 8L583 2/

M-MANUFACTURING
 P.O. BOX 897
 ROANOKE, TX 76272

Plant
 HYW. 114 & DOVE RD.
 ROANOKE, TX 76262



CAGE code: 2/

MMG ENGINEERED COMPONENTS INC.
 DBA TOOLSOURCE
 3901 N. CARNATION
 FRANKLIN PARK, IL 60131-1201

SOCKET HEAD
 CAP SCREWS

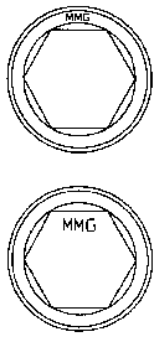
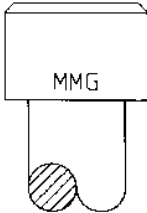

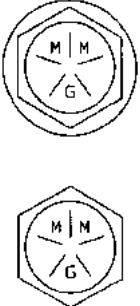
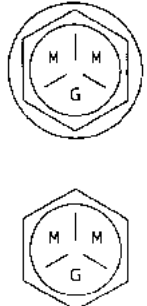

HEX HEADS
 (GRADE 8)

HEX HEADS
 (GRADE 5)

OTHER

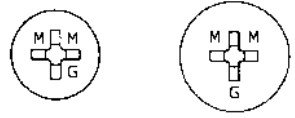
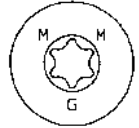
CAGE code: 3JMF9 1/

1/ Information published in this revision was verified by direct contact with manufacturers.
 2/ Information not verified to be current, no response from manufacturer. Information identical to that published in MIL-HDBK-57, Revision B.

MNP CORPORATION
P.O. BOX 189002
UTICA, MI 48318-9002

MNP FASTENER DIVISION
44225 UTICA RD
UTICA, MI 48318-9002
CAGE code: 3R364

PLANT 2
MNP CORPORATION DIVISION 2
1524 E 14 MILE RD
MADISON HEIGHTS, MI 48071-1542
CAGE code: 064S9

PLANT 4
MNP CORPORATION DIVISION 4
2211 BEARD STREET
PORT HURON, MI 48060-6424
CAGE code: 1U3X0

MNP fasteners



Highland bolts & nut



Small screw



Viking fasteners



CAGE code: 3R364, 064S9, 1U3X0 1/

MODERN METRIC MACHINE COMPANY
INC
101 W. NICHOLSON ROAD
AUDOBON, NJ 08106-1411



CAGE code: 1F6H56 2/

MODFORM-ILLINOIS, INC.
500 36TH ST
EAST MOLINE, IL 61244



CAGE code: 46501 2/

MONADNOCK COMPANY, THE
DBA LISI AEROSPACE
18301 ARENTH AVE.
CITY OF INDUSTRY, CA 91748-1226

See LISI AEROSPACE

. (a dot)

CAGE code: 60119 1/

1/ Information published in this revision was verified by direct contact with manufacturers.

2/ Information not verified to be current, no response from manufacturer. Information identical to that published in MIL-HDBK-57, Revision B.

MONOGRAM AEROSPACE FASTENERS
3423 SOUTH GARFIELD AVE.
LOS ANGELES, CA 90040-3103

FASTENER HEAD MARKINGS

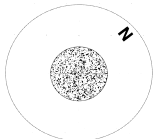

SCRIPT "N"
Used on Visu-Lok® blind fasteners

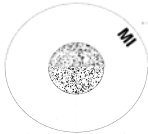

SCRIPT "MI"
Used on Composi-Lok®, OSI-Bolt®, Ti-OSI™, Radial-Lok®, Maf honeycomb pins, and other blind fasteners

BODY MARKINGS

**MONOGRAM
WEDGELOCK**



Trademark "WedgeloK" or "Monogram", depressed. Used on temporary fasteners

CAGE code: 98524 1/

MONROE MACHINED PRODUCTS, INC.
1422 S. 192nd ST
SEATTLE, WA 98148-2314



CAGE code: 7F311 2/

MONTEREY MACHINE PRODUCTS
1504-A INDUSTRIAL PARK STREET
COVINA, CA 91722-3417

MP

CAGE code: 1UD00 2/

MORTON FASTENERS INC.
4544 RUNWAY DR.
LANCASTER, CA 93536

MFI

CAGE code: 4DU57 1/

MORTON MANUFACTURING
(DIVISION MORTON GRINDING)
17341 W. SIERRA HIGHWAY
SANTA CLARITA, CA 91351-1162

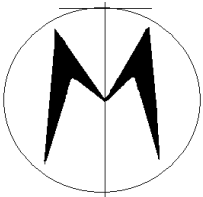
CAGE code: 2T498 1/

MOSTAR GEAR & MACHINE MFG., CO.
201 E. FRANKLIN
PALESTINE, IL 62451



CAGE code: OHN25 2/

1/ Information published in this revision was verified by direct contact with manufacturers.





2/ Information not verified to be current, no response from manufacturer. Information identical to that published in MIL-HDBK-57, Revision B.

<p>MOTOR WHEEL CORP. 4000 COLLINS RD. LANSING, MI 48910</p> <p>Plant 1600 N. LARCH STREET LANSING, MI 48906</p>  <p>CAGE code: 4H871 <u>2/</u></p>
<p>MRL MANUFACTURING CORP. P.O. BOX 8440 59 LEE AVE HALEDON, NJ 07508</p> <p>Plant 525 LAFAYETTE AVENUE HAWTHORE, NJ 07506</p>  <p>CAGE code: 0GUF9 <u>1/</u></p>
<p>N.S.S. INDUSTRIES 9075 GENERAL DRIVE PLYMOUTH, MI 48170</p>  <p>CAGE code: <u>2/</u></p>

<p>NAFCO INDUSTRIES, INC. P.O. BOX 1893 CARSON CITY, NV 89702</p>  <p>CAGE code: 32387 <u>2/</u></p>
<p>NAGOYA SCREW MANUFACTURING CO, LTD. 17-16 TSUBAKI-CHO I NAKAMURA-KU NAGOYA-SHI AICHI-KEN, JAPAN</p>  <p>CAGE code: SC006 <u>2/</u></p>
<p>NAPIER'S AUTO BODY 49879 HWY 101 STH. P. O. BOX 278 BRANDON, OR 97411-1824</p>  <p>CAGE code: 1NXQ4 <u>1/</u></p>

1/ Information published in this revision was verified by direct contact with manufacturers.

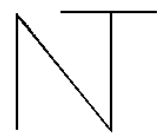



2/ Information not verified to be current, no response from manufacturer. Information identical to that published in MIL-HDBK-57, Revision B.

<p>NARRAGANSETT SCREW MFG., CO. P.O. BOX 2242 119 ROWLEY ST WINSTED, CT 06098 - 2068</p> <p style="text-align: center;">NS</p> <p>CAGE code: OHP15 <u>2/</u></p>	<p>NATIONAL BOLTS & RIVETS LTD. P.O. BOX 5063, BOKSBURG NORTH 1461 SOUTH AFRICA</p> <p style="text-align: center;"></p> <p>CAGE code: V3674 <u>2/</u></p>
<p>NASSAN TOOL WORKS, INC. 34 LAMAR ST. WEST BABYLON, NY 11704</p> <p style="text-align: center;">NTW</p> <p>CAGE code: 2M490 <u>1/</u></p>	<p>NATIONAL FASTENER CO., LTD. #973 YANG DUCK-DANG MASAN REPUBLIC OF KOREA</p> <p style="text-align: center;">O</p> <p>CAGE code: <u>2/</u></p>
<p>NASU DENKI-TEKKO CO., LTD. 1-1-14 SHINJUKU, SHINJUKU-KU TOKYO 160 JAPAN</p> <p style="padding-left: 40px;">SUNAMACHI FACTORY 3-5-28 SHINSUNA, ETO-KU, TOKYO, JAPAN 136</p> <p style="text-align: center;"></p> <p>CAGE code: <u>2/</u></p>	<p>NATIONAL THREADED FASTENERS CORP. 630 LIVELY BOULEVARD ELK GROVE VILLAGE, IL 60007</p> <p style="text-align: center;"></p> <p>CAGE code: <u>2/</u></p>
<p>NAVPAR, INC. 11029 STATE ROUTE 128 BLDG C-1 HARRISON, OH 45030-9710</p> <p style="text-align: center;">NI</p> <p>CAGE code: 0MHC4 <u>1/</u></p>	<p>NAVPAR, INC. 11029 STATE ROUTE 128 BLDG C-1 HARRISON, OH 45030-9710</p> <p style="text-align: center;"></p> <p>CAGE code: 0MHC4 <u>1/</u></p>

1/ Information published in this revision was verified by direct contact with manufacturers.

2/ Information not verified to be current, no response from manufacturer. Information identical to that published in MIL-HDBK-57, Revision B.

<p>NC AUTOMATED INDUSTRIES INC. 90 DAYTON AVENUE BLDG. 14E PASSAIC, NJ 07055-7035</p> <p style="text-align: center;">NAC</p> <p>CAGE code: 1VPZ8 <u>1/</u></p>
<p>NCMI BRUEGGEMANN INC. 1207 W. BROOKS STREET ONTARIO, CA 91762-3609</p> <p style="text-align: center;"></p> <p>CAGE code: 0K292 <u>1/</u></p>
<p>ND INDUSTRIES DBA ND WESTERN FASTENER PROCESSING DIVISION 13929 DINARD AVENUE SANTA FE SPRINGS, CA 90670</p> <p style="text-align: center;">ND INDUSTRIES</p> <p>CAGE code: 4Y667 <u>2/</u></p>

<p>NEDSCHROEF NEDSCHROEF HALMOND B.V. P.O. BOX 29 5700 AA HELMOND THE NETHERLANDS</p> <p style="text-align: center;">Plant KANAALDIJK NOORD WEST 71 5707 LC HELMOND THE NETHERLANDS</p> <p style="text-align: center;"> Standard hexagon high tensile bolts and screws of all property classes</p> <p style="text-align: center;"> High strength friction grip bolts for structural bolting property class 10.9</p> <p style="text-align: center;"> Socket screws</p> <p style="text-align: center;"> Nuts and all other bolts and screws</p> <p>CAGE code: HO871 <u>2/</u></p>
<p>NEKG HOLDINGS 26709 SOUTH KIMBERLY CHANNAHON, IL 26709</p> <p style="text-align: center;">NE</p> <p>CAGE code: 4YU01 <u>1/</u></p>
<p>NELSON AEROSPACE INC. 10310 NORRIS AVE PACOIMA , CA 91331-2219</p> <p style="text-align: center;">NA</p> <p>CAGE code: 52930 <u>2/</u></p>







1/ Information published in this revision was verified by direct contact with manufacturers.

2/ Information not verified to be current, no response from manufacturer. Information identical to that published in MIL-HDBK-57, Revision B.

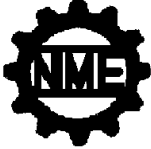
<p>NELSON STUD WELDING DIVISION 7900 W. RIDGE RD ELYRIA, OH 44036-2019</p> <p style="text-align: center;">N</p> <p>CAGE code: 85105 <u>2/</u></p>	<p>NEVILLE MACHINE SHOP P.O. BOX 22 RANGER, TX 76470-2722</p> <p style="text-align: center;">Plant 406 E. HIWAY 80 RANGER, TX 76470-2722</p> <p style="text-align: center;">ND</p> <p>CAGE code: 8X524 <u>2/</u></p>
<p>NEUMAYER, ERICH GMBH POSTFACH 1160 WILHELM-ZANGEN-STRASSE 9 D-7613 HAUSACH GERMANY</p> <p style="text-align: center;">N</p> <p>CAGE code: C1956 <u>1/</u></p>	<p>NEW HORIZON MACHINE CO., INC. 36 LUDLOW STREET STAMFORD, CT 06902-2691</p> <p style="text-align: center;">NH</p> <p>CAGE code: 1VVZ7 <u>2/</u></p>
<p>NEVADA BOLT AND MFG CO INC. DBA SPS NON-FERROUS ENGINEERED FASTENERS 3850 W PONDEROSA WAY LAS VEGAS, NV 89118</p> <p style="text-align: center;">NF</p> <p>CAGE code: 7U566 <u>2/</u></p>	<p>NICE TOOL MFG., INC. 3280 DIANA DR. FORT WORTH, TX 76118-6237</p> <p style="text-align: center;">NT</p> <p>CAGE code: 5K517 <u>2/</u></p>

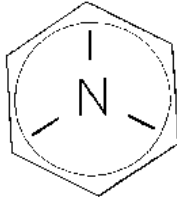
^{1/} Information published in this revision was verified by direct contact with manufacturers.

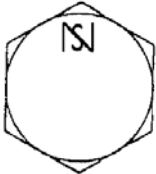
^{2/} Information not verified to be current, no response from manufacturer. Information identical to that published in MIL-HDBK-57, Revision B.

<p>NIPPON MACHINE ENGINEERING, INC. 1311 EAST SAINT GERTRUDE PLACE UNIT B SANTA ANA, CA 92705</p>   <p>CAGE code: 49145 <u>2/</u></p>	<p>NISSAN SCREW CO. LTD. SALES DEPT., FOREIGN TRADE SECTION 5-6-508 SHINKANAOKA-CHO SAKAI-SHI-OASAKA 590 JAPAN</p> <p>Plant 8-4-41 MIYAKE-NAKA MATSUBARA-SHI, OSAKA 580 JAPAN</p>  <p>CAGE code: <u>1/</u></p>
<p>NIPPON STEEL BOLTEN CO., LTD. 4-3-2 NISHIZUMI, YUKUHASHI, FUKUOKA, JAPAN 824</p>  <p>CAGE code: <u>2/</u></p>	<p>NOCHIA STEELWORKS NYOGO, JAPAN</p>  <p>CAGE code: <u>2/</u></p>
<p>NISCO, INC. 5F SHINGA BLDG. 1-3-10 UMEBAYASHI OUTSU-SHI SHOGA-KEN 520, JAPAN</p> <p>Plant 1018-1 ROKUJO CHUZU-CHO YASU-GUM SHIGA-KEN 520-24 JAPAN</p>   <p>CAGE code: <u>2/</u></p>	<p>NON-FERROUS BOLT & MANUFACTURNG CO. 4086 NEVSO DRIVE, SUITE C LAS VEGAS, NV 89103</p> <p>Plant 3850 WEST PONDEROSA LANE LAS VEGAS, NV 89118</p>  <p>CAGE code: <u>2/</u></p>

1/ Information published in this revision was verified by direct contact with manufacturers.

2/ Information not verified to be current, no response from manufacturer. Information identical to that published in MIL-HDBK-57, Revision B.

NORTHBRIDGE FASTENERS
 VIKING ROAD
 WIGSTON, LEICESTER
 UNITED KINGDOM

NB



E – The plain letter E is used for Rolls Royce, UK supply and Europe and will be used in the absence of any customer allocated identification.



32219 – Allocated by Pratt & Whitney, East Hartford for supply to Pratt & Whitney, East Hartford



15077 – Allocated by Pratt & Whitney, Canada for supply to Pratt & Whitney, Canada



51572 – Milscap No. for items supplied to U.S. Government



20733 – Allocated by Avco-Lycoming for supply to Avco-Lycoming



NTF99 – Allocated by General Electric for supply to Rolls Royce for joint projects with General Electric

CAGE code: 2/

NORTH EAST FASTENERS
 8 TREMCO DRIVE
 P. O .BOX 322
 TERRYVILLE, CT 06786-0322



2 dots
 either indented or raised.

CAGE code: 07ZN5 1/

NORTHEAST METAL CO., INC.
 P.O. BOX 51754
 34 FRONT STREET
 INDIAN ORCHARD, MA 01151

Plant
 AIRPORT DRIVE
 WESTFIELD, MA 01085



CAGE code: 1C4F2 2/

NORTHERN SCREW CO. , INC.
 8121 LAKEVIEW PARKWAY
 PLEASANT PRAIRIE, WI 53158

NS

CAGE code: 2/



NORTHSTAR ENGINEERING
 1911 LYNX PLACE
 ONTARIO, CA 91761

0XK38

CAGE code: 0XK38 2/

1/ Information published in this revision was verified by direct contact with manufacturers.

2/ Information not verified to be current, no response from manufacturer. Information identical to that published in MIL-HDBK-57, Revision B.

<p>NOVA MACHINE PRODUCTS CORPORATION A SUBSIDIARY OF CURTIS-WRIGHT FLOW CONTROL SERVICE CORP. 18685 SHELDON ROAD MIDDLEBURGE HEIGHTS, OH 44130-2465</p>  <p>CAGE code: 1EJ29 1/</p>
<p>NT ENGINEERING, INC. 1050 "C" INDEPENDENCE AVE. MOUNTAIN VIEW, CA 94043</p> <p style="text-align: center;">NT</p> <p>CAGE code: 0BEN1 2/</p>
<p>NUCOR CORP. NUCOR FASTENER DIVISION P.O. BOX 6100, 6730 COUNTY ROAD ST. JOE, IN 46785</p>  <p>CAGE code: 0BEP9 1/</p>

<p>NUMERIC MACHINE PRODUCTS 1769 WEST AVE. K-11 LANCASTER, CA 93534</p> <p style="text-align: center;">NMP</p> <p>CAGE code: 5V524 2/</p>
<p>NUTS INCORPORATED DIVISION OF STANLOK 1451 GRAFTON ST P.O. BOX 2735 WORCHESTER, MASSACHUSETTS 01613</p> <p style="text-align: center;">N</p> <p>CAGE code: 02972 2/</p>
<p>NUTS, INC. ROUTE 724 & 23 PHOENIXVILLE, PA 19460-1838</p> <p style="text-align: center;">N</p> <p>CAGE code: 6N185 2/</p>

1/ Information published in this revision was verified by direct contact with manufacturers.

2/ Information not verified to be current, no response from manufacturer. Information identical to that published in MIL-HDBK-57, Revision B.

NYLOK CORP.
15260 HALLMARK DR.
MACOMB, MI 48042

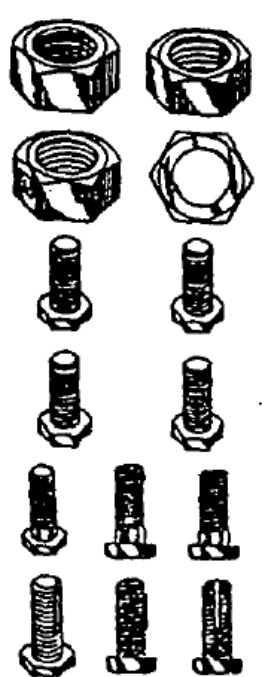

Blue nylon locking element

Blue nylon locking element

Blue nylon locking element

Blue nylon locking element

Blue nylon locking element

Blue nylon locking element

NK

NK

NYLOK

CAGE code: 59093 1/

OAKTREE FASTENERS CO.
12262 1/2 WOODRUFF AVE.
DOWNEY, CA 90241

OTF

CAGE code: 2/

OBARS MACHINE & TOOL CO.
115-126 N. WESTWOOD AVE.
TOLEDO, OH 43607

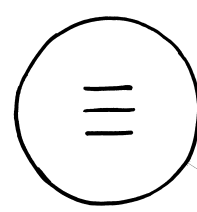

CAGE code: 0MKX0 2/

OCM MACHINE COMPANY, INC.
9601 HIGHWAY 80
FORT WORTH, TX 76116 - 2689



CAGE code: 06XQ6 2/

OHIO NUT & BOLT CO., THE
DIV. OF FASTENERS INDUSTRIES, INC.
33 LOU GROZA BLVD..
BEREA, OH 44017-1293



Small raised mark usually
on the underside of head

CAGE code: 76871 1/

1/ Information published in this revision was verified by direct contact with manufacturers.

2/ Information not verified to be current, no response from manufacturer. Information identical to that published in MIL-HDBK-57, Revision B.

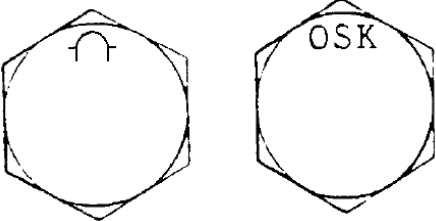
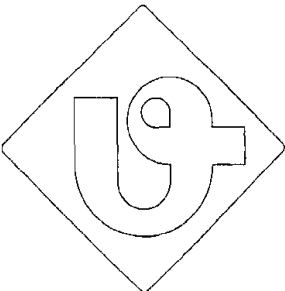
<p>OHKAWA SCREW MFG. CO., LTD. 2-25-16 MIDORIGAOKA, MEGURO-KU, TOKYO 152 JAPAN</p> <p>Plant 6357-1 OBA, OHMIYA-MACHI, NAKA-GUN, LBARAGI-KEU 319-21 JAPAN</p>  <p>CAGE code: <u>2/</u></p>
<p>OKABE CO., INC. OKABE KIKO CO., LTD. (PLANT) 4-21-15 MUKOJIMA SUMIDA-KU, JAPAN 131-8505</p>  <p>CAGE code: SP186 <u>2/</u></p>
<p>OKAI IRON WORKS, INC. 12-41, 3 CHOME, TSURUHARA IZUMISANO CITY OSAKA, JAPAN 598</p> <p>OK</p> <p>CAGE code: <u>2/</u></p>

<p>OKAWA SCREW MANUFACTURING CO., LTD 2-20-4 HIGASHIGOTANDA SHINAGAWA-KU, 141-0022 TOKYO</p> <p>OSK</p>  <p>CAGE code: <u>1/</u></p>
<p>OMEGA THREAD ROLLING AND GRINDING INC. 54 LEWIS STREET P.O. BOX 129 PLAINVILLE, CT 06062-0129</p>  <p>CAGE code: 06KW4 <u>2/</u></p>
<p>ONEIDA TOOL & MACHINE CORP. 837 AIR PARK RD. RHINELANDER, WI 54501-8426</p>  <p>CAGE code: OJHAO <u>1/</u></p>

1/ Information published in this revision was verified by direct contact with manufacturers.

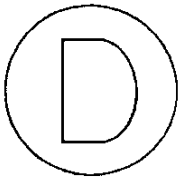

2/ Information not verified to be current, no response from manufacturer. Information identical to that published in MIL-HDBK-57, Revision B.

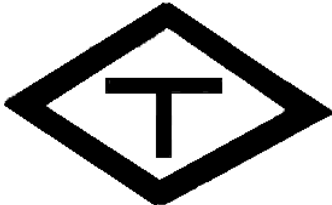

<p>ONO MANUFACTURER, INC. 602 FUJITA OKAYAMA-SHI, OKAYAMA-KEN 701-0221 JAPAN</p> <p>Plant 3-800-46 TAMAHARA TAMANO-SHI, OKAYAMA-KEN 706-2555 JAPAN</p>  <p>CAGE code: 1/</p>
<p>ONTIC ENGINEERING & MANUFACTURING, INC. 20360 PLUMMER ST. NORTH HOLLYWOOD, CA 91609-0510</p>  <p>CAGE code: 45934 2/</p>
<p>ORANGE PRECISION PARTS 17632 METZLER LANE, #C HUNTINGTON BEACH, CA 92647</p> <p style="text-align: center;">P O OP</p> <p>CAGE code: 9V210 2/</p>

<p>ORC-O TOOL & MACHINE, INC. 75 SHAMROCK DRIVE SULLIVAN, MO 63080-2344</p> <p style="text-align: center;">ORC-O</p> <p>CAGE code: 0C1D0 2/</p>
<p>ORDNANCE PARTS & ENGINEERING CO. P.O. BOX 8035 3152 C MAJOR ST FORT WORTH, TX 76112</p>  <p>CAGE code: 20800 2/</p>
<p>ORLOTRONICS CORP. 401 E. FOURTH STREET BRIDGEPORT, PA 19405-1815</p> <p style="text-align: center;">(OTC)</p> <p>CAGE code: 54267 1/</p>
<p>OSAKA SEIKI CO., LTD. 1-19-14, MITEJIMA TOKYO 555 JAPAN</p>  <p>CAGE code: S4247 2/</p>

1/ Information published in this revision was verified by direct contact with manufacturers.

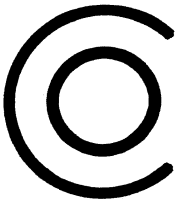
2/ Information not verified to be current, no response from manufacturer. Information identical to that published in MIL-HDBK-57, Revision B.

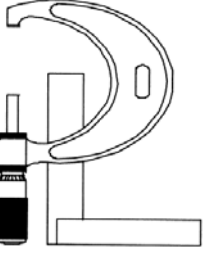
<p>OSTEEN MACHINE SHOP RT. 1 BOX 2082 ALVARADO, TX 76009</p> <p style="text-align: center;"></p> <p>CAGE code: 8Y546 <u>2/</u></p>
<p>OTO MELARA S.p.A. FINKECCANICA COMPANY VIA VALDILOCCHI 15 LA SPEZIA 19136 ITALY</p> <p style="text-align: center;"></p> <p>CAGE code: A0199 <u>1/</u></p>
<p>OTT BROTHERS MACHINE CO., INC. 331 EAST 37TH STREET SOUTH WICHITA, KS 67216</p> <p style="text-align: center;">OB OBMC</p> <p>CAGE code: 09292 <u>1/</u></p>
<p>OWARI PRECISE PRODUCTS CO., LTD 2-148 YADA-CHO HIGASHI-KU NAGOYA- SHI AICHI-KEN, JAPAN</p> <p style="text-align: center;"></p> <p>CAGE code: SC008 <u>2/</u></p>

<p>P & I ASSOCIATES, INC. 26 WEST WAVERLY ROAD P.O. BOX 413 GLENSIDE, PA 19038-4012</p> <p style="text-align: center;">Plant #1 LIMEKILN PIKE GLENSIDE, PA 19038 (No mail to this address)</p> <p style="text-align: center;"></p> <p>CAGE code: 0DH98 <u>2/</u></p>
<p>P & L ENTERPRISES 111 CR 4614 CASTROVILLE, TX 78009</p> <p style="text-align: center;"></p> <p>CAGE code: 058B7 <u>1/</u></p>
<p>P.C.M., INC. (BETHLEHEM PIKE INDUSTRIAL CENTER) P.O. BOX 840 60 PARRISH ST. WILKES BARRE, PA 18710</p> <p style="text-align: center;"></p> <p>CAGE code: <u>2/</u></p>

1/ Information published in this revision was verified by direct contact with manufacturers.

2/ Information not verified to be current, no response from manufacturer. Information identical to that published in MIL-HDBK-57, Revision B.

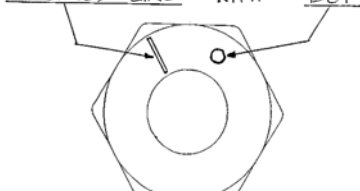



<p>P.S. MACHINE CO., INC. 1505 JOHN FETCH BLVD. S. WINDSOR, CT 06074-1000</p> <div style="text-align: center; border: 1px solid black; width: 60px; margin: 20px auto; padding: 5px;">PS</div> <p>CAGE code: 56839 <u>1/</u></p>
<p>PABCOR, INC. 925 NORTH CEDAR STREET P.O. BOX 7528 NEW CASTLE, PA 16107-1323</p> <div style="text-align: center; font-size: 2em; margin: 20px auto;">PABCOR</div> <p>CAGE code: OAGN7 <u>2/</u></p>
<p>PACER ALLOYS, INC. 8681 SCRANTON STREET HOUSTON, TX 77075</p> <div style="text-align: center; font-size: 2em; margin: 20px auto;">V</div> <p>CAGE code: <u>1/</u></p>
<p>PACIFIC FASTENERS, INC. 405 UNIVERSITY AVENUE ARLINGTON HEIGHTS, IL 60004</p> <div style="text-align: center; margin: 20px auto;"> <p><u>INDENTED LINE</u> WITH <u>DOT</u></p>  </div> <p>CAGE code: 42918 <u>2/</u></p>

<p>PACIFIC SCIENTIFIC 22715 SAVI RANCH PARKWAY P.O. BOX 87019 YORBA LINDA, CA 92686</p> <div style="text-align: center; font-size: 3em; margin: 20px auto;">P S</div> <p>CAGE code: 45402 <u>2/</u></p>
<p>PACIFIC TOOL, INC. 15235 NE 92ND STREET REDMOND, WA 98052</p> <div style="text-align: center; margin: 20px auto;"> <div style="border: 1px solid black; border-radius: 50%; width: 100px; height: 100px; display: flex; align-items: center; justify-content: center;"> <div style="text-align: center; margin-right: 10px;">T</div> <div style="display: flex; justify-content: space-around; width: 60px;"> P I </div> </div> </div> <p>CAGE code: 62176 <u>1/</u></p>
<p>PADGETT MACHINE INC. 1226 NORTH 143rd EAST AVENUE TULSA, OK 74116-2120</p> <div style="text-align: center; font-size: 3em; margin: 20px auto;">PMI</div> <p>CAGE code: 6W037 <u>1/</u></p>
<p>PAINTER TOOL, INC. 1173 IRIS DRIVE NORTH HUNTINGDON, PA 15642-4399</p> <div style="text-align: center; font-size: 3em; margin: 20px auto;">PTI</div> <p>CAGE code: 34779 <u>2/</u></p>

1/ Information published in this revision was verified by direct contact with manufacturers.

2/ Information not verified to be current, no response from manufacturer. Information identical to that published in MIL-HDBK-57, Revision B.

<p>PALNUT CO. , THE UNITED CARR FASTENERS PALNUT DIV GLEN ROAD MOUNTAINSIDE, NJ 07092</p> <p>PAL</p> <p>CAGE code: 2G832 2/</p>
<p>PARK PRECISION CORPORATION 181 ELLIOT ST. UNIT 403 BEVERLY, MA 01915</p> <p>-PPC-</p> <p>CAGE code: OJWS2 2/</p>
<p>PATEREX, LTD. CRAY AVE., ORPINGTON KENT BR5 3RR UNITED KINGDOM</p> <p>P PTX</p> <p>CAGE code: OBMF6 2/</p>
<p>PATTERSON LAKE PRODUCTS (SUBSIDIARY OF COLUMBIA AUTO PARTS) P.O. BOX 200 PINCKNEY, MI 48169</p> <p>PP</p> <p>CAGE code: 5Y952 2/</p>

<p>PAULIN, H. & CO., LTD. CAPITAL METAL INDUSTRIES DIVISION 55 MILNE AVENUE SCARBOROUGH, ONTARIO MIL 4N3 CANADA</p> <p> </p> <p>CAGE code: 95119 2/</p>
<p>PB FASTENERS (DIVISION OF PAUL R. BRILES, INC.) 1700 WEST 132ND STREET GARDENA, CA 90249</p> <p>MFR 27624</p> <p></p> <p>PBA PBF PB</p> <p>CAGE code: 27624 1/</p>
<p>PEERLESS SCREW PRODUCTS 286 SANDBANK RD. P.O. BOX 236 CHESIRE, CT 06410-1537</p> <p></p> <p>CAGE code: 45950 1/</p>

1/ Information published in this revision was verified by direct contact with manufacturers.

2/ Information not verified to be current, no response from manufacturer. Information identical to that published in MIL-HDBK-57, Revision B.

PEINER UMFORMTECHNIK GmbH
 WOLTORFER STRASSE 26
 PEINE, 31224
 GERMANY

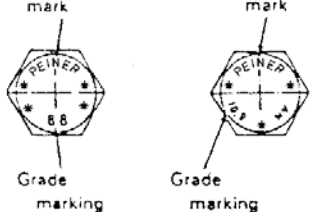
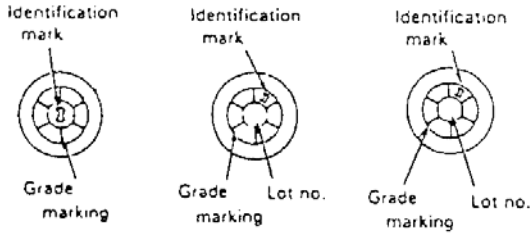
CAGE code: D2742 2/

PELHAM AUTO MATRIX PRECISION
 1 INDUSTRIAL DRIVE
 PELHAM, NH 03076



CAGE code: 1CSJ5 2/

PENN CIGAR MACHINES INC (P.C.M INC)
 P. O. BOX 1065
 60 PARRISH STREET
 WILKES BARRE, PA 18703



CAGE code: 7U218 2/





PENNENGINEERING AUTOMOTIVE
 FASTENERS
 50625 DESIGN LANE
 SHELBY TOWNSHIP, MI 48315

(Coporate see PENN ENGINEERING &
 MANUFACTURING CORP.)

PE

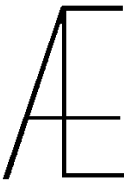
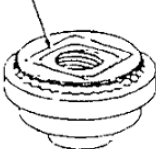
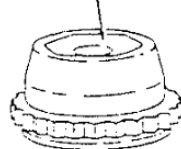
CAGE code: 50EB1 1/

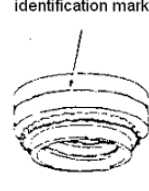

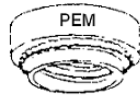
PENN ENGINEERING & MANUFACTURING
 CORP.
 (see ATLAS ENGINEERING, INC.)
 5190 OLD EASTON RD.
 DANBORO, PA 18916

CAGE code: 46384 1/

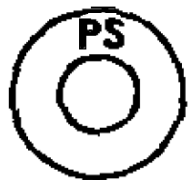

1/ Information published in this revision was verified by direct contact with manufacturers.
 2/ Information not verified to be current, no response from manufacturer. Information identical to that published in MIL-HDBK-57, Revision B.

<p>PENN SCREW & MACHINE WORKS, INC. 3075 ADVANCE LN. COLMAR, PA 18915</p> <p style="text-align: center;">PSM PSM</p> <p>CAGE code: 82926 <u>2/</u></p>
<p>PEREZ MACHINE, INC. 1501 W. 134TH STREET GARDENA, CA 90249</p> <p style="text-align: center;">PMI</p> <p>CAGE code: 34393 <u>1/</u></p>
<p>PERIGEE MANUFACTURING COMPANY, INC. (MICHIGAN CORPORATION) 7519 INTERVALE DETROIT, MI 48238-2401</p> <p style="text-align: center;"></p> <p>CAGE code: 1X4X7 <u>1/</u></p>
<p>PERKINS MACHINE CO. 1559 PINE STREET OXNARD, CA 93030</p> <p style="text-align: center;"></p> <p>CAGE code: 84749 <u>2/</u></p>

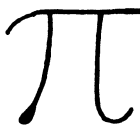
<p>PHOENIX SPECIALTY MANUFACTURING CO., INC. P.O. BOX 418 BAMBERG, SC 29003</p> <p style="text-align: center;">Plant HIGHWAY 301 SOUTH BAMBERG, SC 29003</p> <p style="text-align: center;"></p> <p>CAGE code: 66920 <u>2/</u></p>
<p>PILGRIM SCREW CORP. (PROVIDENCE DIVISION) 120 SPRAGUE STREET PROVIDENCE, RI 02901</p> <p style="text-align: center;">Plant 259 DEXTER ST. PROVIDENCE, RI 02907 CAGE code: 47253</p> <p style="text-align: center;"></p> <p style="text-align: center;">Plant 2 2875 WEST FRYE ROAD CHANDLER, AZ CHANDLER, AZ CAGE code: 1GP79</p> <p style="text-align: center;"></p> <p>CAGE code: 47253, 1GP79 <u>1/</u></p>





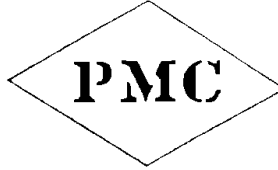

1/ Information published in this revision was verified by direct contact with manufacturers.
2/ Information not verified to be current, no response from manufacturer. Information identical to that published in MIL-HDBK-57, Revision B.

<p>PINE TAVERN MACHINE INC. 7851 PINE TAVERN ROAD PERRY, NY 14530</p> <p>PTM</p> <p>CAGE code: 9J559 <u>2/</u></p>
<p>PINEY RIDGE CO. 177 JOSHUA ROAD SALUDA, SC 29138-7770</p> <p>PR</p> <p>CAGE code: 05DT2 <u>1/</u></p>
<p>PINTO PRODUCTS P.O. BOX 83 2011 PALMER STREET KALAMAZOO, MI 49001</p>  <p>CAGE code: 0YJH8 <u>2/</u></p>
<p>PIONEER MACHINE PRODUCTS, INC. 2200 DOLMAN ST. LOUIS, MO 63104</p> <p>PMP</p> <p>CAGE code: 12829 <u>2/</u></p>

<p>PIONEER SCREW & NUT CO. 2700 YORK ROAD ELK GROVE VILLAGE, IL 60007</p>   <p>Indented hex heads and indented hex washer heads</p> <p>All other head styles slash- dot symbol to appear on bearing surface upon request</p> <p>CAGE code: 4N311 <u>2/</u></p>
<p>PLAINVILLE MANUFACTURING CO., INC. 48 LEWIS ST. PLAINVILLE, CT 06062</p>  <p>CAGE code: <u>2/</u></p>
<p>PNEU-HYDRO PRODUCTS, INC. 353 RICHARD MINE ROAD WHARTON, NJ 07885</p> <p>PHP</p> <p>CAGE code: <u>2/</u></p>
<p>POINT MACHINE COMPANY P.O. BOX 8055 33 CAMBRIDGE HEIGHTS KENSINGTON, CT 06037</p>  <p>CAGE code: 9N716 <u>2/</u></p>

^{1/} Information published in this revision was verified by direct contact with manufacturers.



^{2/} Information not verified to be current, no response from manufacturer. Information identical to that published in MIL-HDBK-57, Revision B.

<p>POLYTECHNIC INDUSTRIES 14 ROLAND AVE. MOUNT LAUREL, NJ 08054</p>  <p>CAGE code: 4K539 <u>1/</u></p>	<p>PRD FASTENERS LTD. UNIT 10/15 MONMER CLOSE WILLENHALL, WV12 1JR ENGLAND</p>  <p>CAGE code: U8651 <u>1/</u></p>
<p>PORTLAND BOLT & MFG., CO. P.O. BOX 2866 1210 NW JOHNSON ST PORTLAND, OR 97208</p> <p>Plant 3441 NW GUAM ST PORTLAND, OR 97210-2688 CAGE code: 3QCS3</p>  <p>CAGE code: 3S498, 3QCS3 <u>1/</u></p>	<p>PRECI-MANUFACTURING, INC. 400 WEAVER STREET WINOOSKI, VT 05404-1391</p>  <p>CAGE code: 66841 <u>1/</u></p>
<p>PORTSMOUTH NAVAL SHIPYARD SEAVEY ISLAND KITTEERY, ME 03904</p>  <p>CAGE code: 81316 <u>1/</u></p>	<p>PRECISE AERO PRODUCTS 4120 INDUS WAY RIVERSIDE, CA 92503-4808</p>  <p>CAGE code: 00AE2 <u>1/</u></p>
<p>POWERPARTS, INC. P.O. BOX 38557 601 MCFARLAND STREET HOUSTON, TEXAS 77011</p>  <p>CAGE code: 66297 <u>2/</u></p>	

1/ Information published in this revision was verified by direct contact with manufacturers.

2/ Information not verified to be current, no response from manufacturer. Information identical to that published in MIL-HDBK-57, Revision B.

PRECISE OF CALIFORNIA
 DIV OF ADJUSTABLE BUSHING CORP
 8330 LANKERSHIM BLVD.
 NORTH HOLLYWOOD, CA 91605

Panel fastener Quick-acting pins

CAGE code: 62372 2/

PRECISION AIRCRAFT MACHINING CO.,
 INC. DBA PAMCO
 10640 ELKWOOD STREET
 SUN VALLEY, CA 91352

PAMCO

PAM

CAGE code: 66774 1/

PRECISION METAL PRODUCTS CO.
 #7 CENTENNIAL DRIVE
 CENTENNIAL INDUSTRIAL PARK
 PEABODY, MA 01961-6026



CAGE code: 4V472 2/

PRECISION PARTS & TOOL CO., INC.
 108 ROME STREET
 FARMINGDALE, NJ 11735

L.P.R.

CAGE code: 2/

.PRECISION PIECE PARTS, INC.
 712 S. LOGAN ST.
 MISHAWAKA, IN 46544



CAGE code: 98072 2/

PRECISION SCREW & BOLT, INC.
 1491 CHARDON ROAD
 CLEVELAND, OH 44117-1598

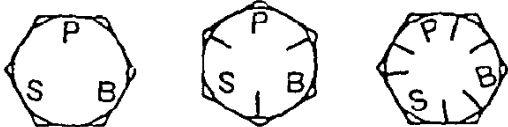

GRADE 2 GRADE 5 GRADE 8

CAGE code: 02BC3 1/

PRECISION TECHNOLOGIES, INC.
 1538 INDUSTRIAL AVE.
 OTTAWA, KS 66067

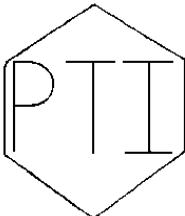



CAGE code: 2/

1/ Information published in this revision was verified by direct contact with manufacturers.



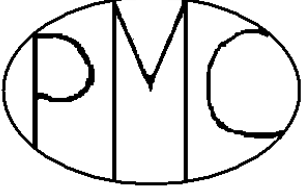

2/ Information not verified to be current, no response from manufacturer. Information identical to that published in MIL-HDBK-57, Revision B.

<p>PRECISIONMATICS CO., INC. HELMER AVE. WEST WINFIELD, NY 13491</p>  <p>CAGE code: <u>2/</u></p>
<p>PREM INDUSTRIES, INC. P.O. BOX 907 NIAGRA FALLS, NY 14302</p> <p>Plant 574-56th ST. NIAGRA FALLS, NY 14304</p>  <p>CAGE code: 4Y327 <u>2/</u></p>
<p>PRICE MANUFACTURING CO. 372 NORTH SMITH AVENUE CORONA, CA 91720</p>  <p>CAGE code: 1K6D8 <u>1/</u></p>

<p>PRIETO MACHINE COMPANY, INC. 1785 STOUT DRIVE UNIT D WARMINSTER, PA 18974</p>  <p>CAGE code: 8Y298 <u>1/</u></p>
<p>PRODUCT DEVELOPMENT GROUP, INC. P.O. BOX 177 ROSE HILLS, KS 67133</p>  <p>CAGE code: OMAR7 <u>2/</u></p>
<p>PRODUCTION & TOOL COMPANY 240 SARGENT DRIVE NEW HAVEN, CT 06511</p>  <p>CAGE code: 8N334 <u>2/</u></p>



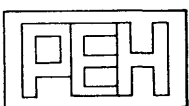



1/ Information published in this revision was verified by direct contact with manufacturers.

2/ Information not verified to be current, no response from manufacturer. Information identical to that published in MIL-HDBK-57, Revision B.

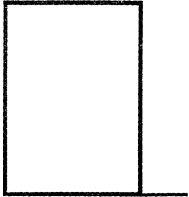
<p>PRODUCTS DESIGN & MFG. CORP. P.O. BOX 11429 NEWINGTON, CT 06111</p> <p>Plant 76 STANWELL RD. NEWINGTON, CT 06111</p> <p>8M938</p> <p>CAGE code: <u>2/</u></p>	<p>PTM INTERNATIONAL INC. 8050 NW 31ST MIAMI, FL 33122</p> <p style="text-align: center;"></p> <p>CAGE code: 0S6M6 <u>2/</u></p>
<p>PRO-MACHINE & TOOL COMPANY 792 BLAKE BOTTOM RD. HUNTSVILLE, AL 35806</p> <p style="text-align: center;"></p> <p>CAGE code: IDS66 <u>2/</u></p>	<p>PURITAS METAL PRODUCTS 7720 RACE RD NORTH RIDGEVILLE , OH 44039-3614</p> <p style="text-align: center;">PMP</p> <p style="text-align: center;">P</p> <p>CAGE code: 04368 <u>1/</u></p>
<p>PROMPTUS ELECTRONIC HARDWARE 520 HOMESTEAD AVENUE MT. VERNON, NY 10550</p> <p style="text-align: center;"></p> <p>CAGE code: 57177 <u>2/</u></p>	<p>PYE & HOGAN MACHINE CO. P. O. BOX 832 167-1 ELM ST OLD SAYBROOK, CT 06475-4134</p> <p style="text-align: center;">MFR06320</p> <p>CAGE code: 06320 <u>1/</u></p>
<p>PROTO MACHINE CO., INC. P.O. BOX 1240 1295 GOLDEN TRIANGLE BLVD. KEELER, TX 76248</p> <p style="text-align: center;"></p> <p>CAGE code: 0AWM2 <u>2/</u></p>	<p>QRP, INC. P.O. BOX 832 2307 MERCANTILE DR NE LELAND, NC 28451-4065</p> <p style="text-align: center;">09094</p> <p>CAGE code: 09094 <u>1/</u></p>



1/ Information published in this revision was verified by direct contact with manufacturers.







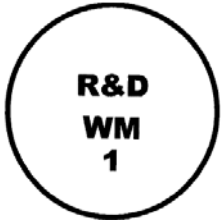



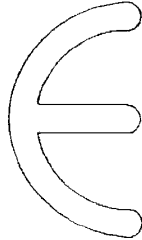

2/ Information not verified to be current, no response from manufacturer. Information identical to that published in MIL-HDBK-57, Revision B.

<p>QSN MANUFACTURING, INC. 201 FRONTIER WAY BENSENVILLE, IL 60106</p>  <p>CAGE code: 0MDU6 <u>2/</u></p>	<p>QUALITY SCREW PRODUCTS, INC. P.O. BOX 2355 35101 SCHOOLCRAFT ROAD LIVONIA, MI 48151</p>  <p>CAGE code: 4F051 <u>2/</u></p>
<p>QUALITY AIRCRAFT SCREWS, INC. 1030-A ORTEGE WAY PLACENTIA, CA 92670</p>  <p>CAGE code: <u>2/</u></p>	<p>QUALITY SOCKET SCREW MANUFACTURING CORP. 2790 NORTH AVE. ENGLEWOOD, IL 34224</p>  <p>Socket head cap screw head marked for I.D. QSS</p> <p>CAGE code: 5N116 <u>1/</u></p>
<p>QUALITY FABRICATIONS, INC. 3270 WROLSSEN DRIVE SAUGERTIES, NY 12477</p>  <p>CAGE code: IJB77 <u>2/</u></p>	<p>QUALITY THREADED PRODUCTS COMPANY 4734 HIGHWAY 157 N. JUDSONIA, ARKANSAS 72081</p>  <p>CAGE code: 0RXV6 <u>2/</u></p>
<p>QUALITY MACHINE & MFG INC. 1316 BLACK VALLEY ROAD LAFOLLETTE, TN 37766</p>  <p>CAGE code: 1DB71 <u>2/</u></p>	

1/ Information published in this revision was verified by direct contact with manufacturers.

2/ Information not verified to be current, no response from manufacturer. Information identical to that published in MIL-HDBK-57, Revision B.

<p>R & D FASTENERS P. O. BOX 250 9604 7TH ST RANCHO CUCAMONGA , CA 91730</p>  <p>CAGE code: 05BE3 2/</p>
<p>R & D WELDING & MACHINE INC. 1200 GEORGIA AVE. WARNER ROBBINS, GA 31093</p>  <p>CAGE code: 1H3J7 2/</p>
<p>R & I ENTERPRISES DBA COMPULOGIC DESIGN CO. 233 PAREDES LINE RD. BROWNSVILLE, TX 78521</p>  <p>CAGE code: 1CHU5 1/</p>
<p>R & R PRECISION 604 S. 9TH ST. GUNNISON, CO 81230</p>  <p>CAGE code: 0GKX6 2/</p>

<p>R B & W CORPORATION A PARK-OHIO COMPANY 5190 BRADCO BLVD. TORONTO, ONTARIO CANADA</p> <p>Plant DELAWARE CORPORATION 8341 TYLER BLVD MENTOR, OH 44060</p>		
		
<p>R B W</p> <p>or</p> <p>E E E</p>	 <p>SAE J995 Grade 5 hex nuts</p>	
<p>L S B L</p> <p>XP exposure protected ASTM A325 Type 3 bolts and nuts</p>	 <p>SAE J995 Grade 8 hex nuts</p>	
 <p>UNA-DRIV[®] SYSTEM</p>	<p>OVALOK[®] TRI-OVAL[®] prevailing torque locknuts</p> <p>Grade B Grade C</p>  	
 <p>RAL-LOCK[®] SYSTEM</p>  <p>LAMSEAL[®] SYSTEM</p>	<p>Class 9 Class 10</p>   <p>Stover[®] prevailing torque locknuts</p>	
<p>AN 310 AN 320</p>  <p>Castellated</p>  <p>Slotted</p>	<p>RB&W Nuts</p>  <p>Not Otherwise Specified (Dots at 180°)</p> <p>CAGE code: 52167</p> <p>Continued 2/</p>	

1/ Information published in this revision was verified by direct contact with manufacturers.

2/ Information not verified to be current, no response from manufacturer. Information identical to that published in MIL-HDBK-57, Revision B.

Continued

R B & W CORPORATION

VIBRESIST[®] locking screws

Grade A Grade B Grade C

VIBRESIST[®] hex locknut

Class 5 Class 9 Class 10

VIBRESIST[®] hex locknut

Grade B Class 9 Class 10

Grade B Grade C Class 9 Class 10

Class 9 Class 10 Type "GT"

CAGE code: 52167 2/

R. BILD COMPANY, INC.
15205 STAGG STREET
VAN NUYS, CA 91405-1003

CAGE code: 04QM7 1/

R.E.C. CORP.
10 BEACH ST.
MOUNT VERNON, NY 10550

Used on all alloy and stainless steel bolts, studs, and nuts over 1/2 inch in diameter.

CAGE code: 86687 2/

RABOURDIN
ZI R DES MARAIS
P.O. BOX BP 157
ST. JUST EN CHAUSSEE,
FRANCE 60130



CAGE code: F4870 2/

RADAX INDUSTRIES, INC.
700 BASKET ROAD
WEBSTER, NY 14580

CAGE code: 6V794 2/

1/ Information published in this revision was verified by direct contact with manufacturers.

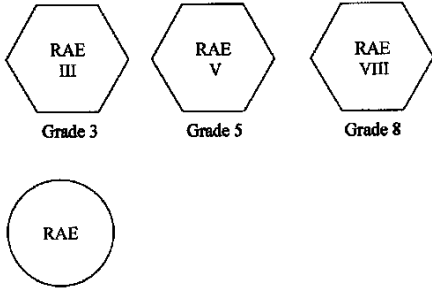
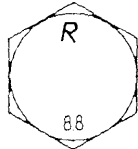
2/ Information not verified to be current, no response from manufacturer. Information identical to that published in MIL-HDBK-57, Revision B.

<p>RAE MANUFACTURING CO. 1327-1331 CEDAR STREET PORT HURON, MI 48060-6167</p>  <p>Grade 3 Grade 5 Grade 8</p> <p>CAGE code: 3FDT8 <u>1/</u></p>
<p>RAHMEDE SCHRAUBENFABRIK WEFELSHOHLER STR 44 D-5880 LUDENSCHIED GERMANY</p>  <p>CAGE code: D9901 <u>2/</u></p>
<p>RAINBOW MACHINE PRODUCTS, INC. P.O. BOX 1906 226 WILLIS ROAD YORK, PA 17405</p>  <p>CAGE code: 9S535 <u>2/</u></p>
<p>RAM ENTERPRISES 1382 CORONADO ST LONG BEACH, CA 90804</p>  <p>CAGE code: OU3C8 <u>2/</u></p>

<p>RAM PRODUCTS AFS TORRANCE OPERATIONS 3016 WEST LOMITA BLVD. TORRANCE, CA 90505-5103</p> <p>(Corporate office see ALCOA FASTENING SYSTEMS)</p> <h1 style="text-align: center;">RAM</h1> <p>CAGE code: 0CBU7</p>
<p>RAM THREADING, INC. P.O. BOX 987 BEAUMONT, TEXAS 77704</p> <p style="text-align: center;">Plant 2640 CROCKETT BEAUMONT, TX 77701</p> <h1 style="text-align: center;">R</h1> <p style="text-align: center;">Centered over grade of material being stamped</p> <p>CAGE code: 1Y826 <u>2/</u></p>
<p>RAMAR NUTS, INC. 18401 WEAVER ST. DETROIT, MI 48228</p> <h1 style="text-align: center;">R</h1> <p>CAGE code: 4L633 <u>2/</u></p>

1/ Information published in this revision was verified by direct contact with manufacturers.

2/ Information not verified to be current, no response from manufacturer. Information identical to that published in MIL-HDBK-57, Revision B.

RAMCO SPECIALTIES, INC.
5369 HUDSON DRIVE
HUDSON, OH 44236

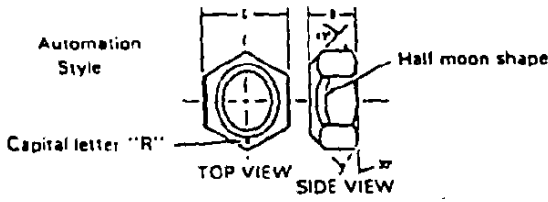

CAGE code: 6U460 1/

RAMM DEFENSE PRODUCTS
3161 D MAJOR ST
FORT WORTH, TX 76112-7270



CAGE code: 0BRC1 1/

RATHMANN WALTER G. SEGMENT-
KLAMMERSCHRAUBEN GMBH
ALTE EMSER STRASSE 32
KOBLENZ, 56077
GERMANY



CAGE code: C6486 2/

RA-WHITE, INC
967 WEST HYDE PARK BOULEVARD
INGLEWOOD, CA 90302



CAGE code: 5Y319 2/

RB & W CORP.
23001 EUCLID AVE.
CLEVELAND, OH 44117

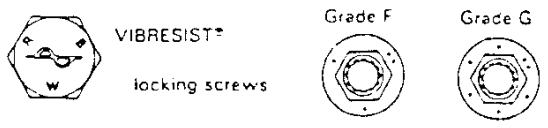
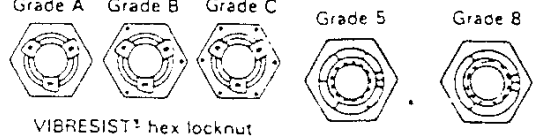
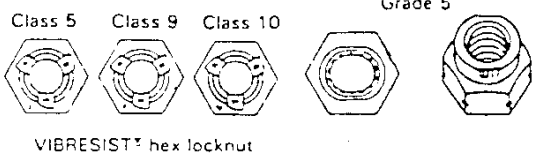
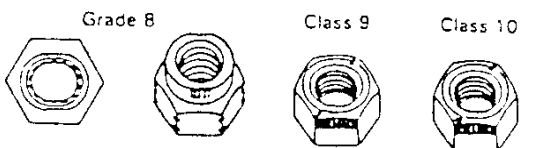
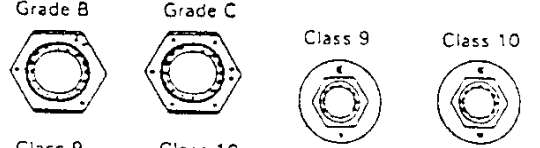
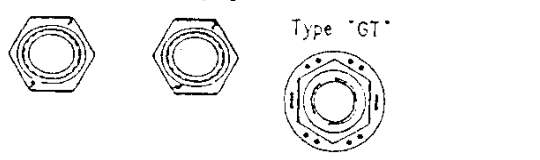
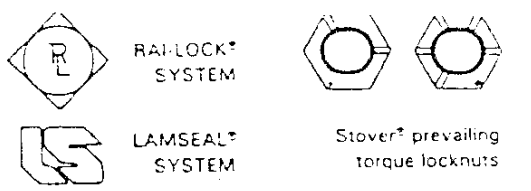
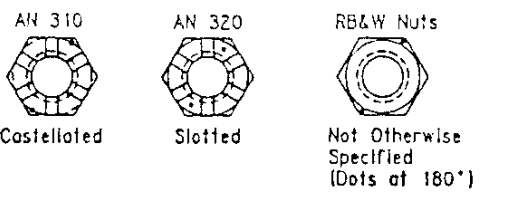
CAGE code: 0VZJ0 2/

1/ Information published in this revision was verified by direct contact with manufacturers.
2/ Information not verified to be current, no response from manufacturer. Information identical to that published in MIL-HDBK-57, Revision B.

<p>REED INSTRUMENT CO. 1525 BLALOCK ROAD HOUSTON, TX 77080</p>  <p>CAGE code: 3B132 2/</p>	<p>(see ALCOA FASTENING SYSTEMS)</p> <p>REXNORD SPECIALITY FASTENERS DIVISION (NOW: ALCOA FASTENING SYSTEMS, TRIDAIR PRODUCTS) 3000 WEST LOMITA BLVD TORRANCE, CA 90505</p>
<p>REGAL AIR, INC. P.O. BOX 1011 108 E. ALABAMA MT. PLEASANT, TX 75455</p> <p style="text-align: center;">4J976</p> <p>CAGE code: 4J976 2/</p>	   <p>(NOW: ALCOA FASTENING SYSTEMS) CAMLOC PRODUCTS 601 ROUTE 46 WEST HASBROUCK HEIGHTS, NJ 07604</p>
<p>REID PRODUCT INC. 21430 WAALEW RD APPLE VALLEY, CA 92307</p> <p style="text-align: center;">Rp 9R R9</p> <p>CAGE code: 59563 1/</p>	  <p>(NOW: ALCOA FASTENING SYSTEMS) ROSAN PRODUCTS 3130 W. HARVARD ST. SANTA ANA, CA 92704</p>
<p>RELIANT FASTENER 201 E. 2ND STREET ROCK FALLS, IL 61071</p>  <p>CAGE code: 2/</p>	<p style="text-align: center;">RI</p> <p>CAGE code: 76017 2/</p>
<p>REPUBLIC FASTENER MANUFACTURING CORP. 1300 RANCHO CONEJO BOULEVARD NEWBURY PARK, CA 91320-1405</p> <p style="text-align: center;">R</p> <p>CAGE code: 52828, 71087 1/</p>	<p>RICHARD MFG. CO., INC. 250 ROCK LANE MILFORD, CT 06460-3853</p>  <p>CAGE code: 4A014 1/</p>

1/ Information published in this revision was verified by direct contact with manufacturers.
2/ Information not verified to be current, no response from manufacturer. Information identical to that published in MIL-HDBK-57, Revision B.

RINCO TECHNOLOGIES, INC.
10275 PHILADELPHIA CT.
RANCHO CUCAMONGA, CA 91730



CAGE code: 4NG33 1/

RING SCREW WORKS
10160 GAINEY RD
HOLLY, MI 48442 - 9331

FENTON HEADING
2480 OWEN RD.
FENTON, MI 48430-1769
CAGE code: 7M992



FERNDALE FASTENER
31600 STEPHENSON HIGHWAY
MADISON HEIGHTS, MI 48071



RING SCREW DEVISION
22100 SHERWOOD AVE.
WARREN, MI 48091



SEMCO FASTENER
4146 EAST BALDWIN RD.
HOLLY, MI 48442



TITAN FASTENER
10031 HOLLY RD.
HOLLY, MI 48442



CAGE code: 0B2C8 2/

RIPPA PRODUCTS
P.O. BOX 328
5 MILE POINT RD
MOHAWK, MI 49950

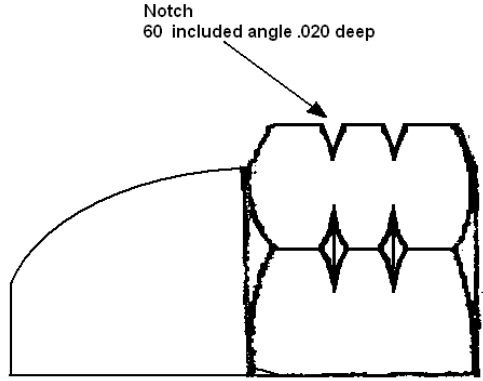

CAGE code: 0R7Z5 2/

RISCO, INCORPORATED
390 RISCO CIRCLE
BEAUMONT, CA 92223-2676

01DC

CAGE code: 6W027 2/

RIVER VALLEY TOOL & MANUFACTURING
P. O. BOX 64
260 AIRPORT INDUSTRIAL ROAD
PARIS, AR 72855

RVT

CAGE code: 3K1M6 1/

1/ Information published in this revision was verified by direct contact with manufacturers.

2/ Information not verified to be current, no response from manufacturer. Information identical to that published in MIL-HDBK-57, Revision B.

RIVNUT ENGINEERED PRODUCTS, INC.
2705 MARION DRIVE
KENDALLVILLE, IN 46755

REP

CAGE code: 0VK23 2/

RMS
1125 W ACACIA AVE
HEMET, CA 92543

R M S

CAGE code: 2/

ROBBINS MANUFACTURING
P.O. BOX 704
1200 AIRPORT ROAD
FALL RIVER, MA 02722





CAGE code: 8T312 1/

ROBERT HENRY CO., INC.
87 OPAL STREET
MILFORD, CT 06460

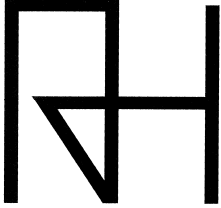

CAGE code: 9J112 2/

ROCKFORD BOLT & STEEL CO.
(SUBSIDIARY OF VARLEN CORPORATION)
126 MILL ST
ROCKFORD, IL 61101-1491



CAGE code: 90483 1/

ROCKFORD FASTENERS INC.
P.O. BOX 884
ROCKFORD, IL 61105

Plant
725 SOUTH STREET
ROCKFORD, IL 61102



CAGE code: 0B998 2/

1/ Information published in this revision was verified by direct contact with manufacturers.

2/ Information not verified to be current, no response from manufacturer. Information identical to that published in MIL-HDBK-57, Revision B.

ROCKFORD PRODUCTS CORP.
707 HARRISON AVE
ROCKFORD, IL 61108

 MSC. OR LOW CARBON	 GENERAL PURPOSE	 GRADE 3	 GRADE 5
 GRADE 5	 GRADE 5.1	 GRADE 5.2	 GRADE 6
 GRADE 7	 GRADE 8	 GRADE 8	 GRADE 8.2
 DURLOK	 STAINLESS	 SAE J-1102	 P3T WITH APPROPRIATE GRADE
 B7	 METRIC GRADE 8.8	 METRIC GRADE 9.8	 METRIC GRADE 10.9
 IND. HEX. HEAT TREAT & NO HEAT TREAT	 IND. HEX. GRADE 3	 IND. HEX. GRADE 5	 IND. HEX. GRADE 5.1
 IND. HEX. GRADE 6	 IND. HEX. GRADE 7	 IND. HEX. GRADE 8	 IND. HEX. STAINLESS
 OLD STYLE PLACE BOLT GRADE 3	 OLD STYLE PLACE BOLT GRADE 6	 NEW STYLE PLACE BOLT GRADE 3	 NEW STYLE PLACE BOLT GRADE 6
 METRIC NEW STYLE PLACE BOLT GRADE 9.8	 METRIC NEW STYLE PLACE BOLT GRADE 10.9	 HEX. NUT GRADE 5	 HEX NUT GRADE 8
	 LOW CARBON	 ROCKALLOY GRADE 8	

CAGE code: 77595 2/

ROGG MANUFACTURING COMPANY
600 DANBURY ROAD
NEW MILFORD, CT 06776

CAGE code: 08625 2/

ROMAC ELECTRONICS, INC.
155 E. AMES CT.
PLAINVIEW, NY 11803

8T968

CAGE code: 8T968 2/

RONSON MANUFACTURING, INC.
9933 CHILLICOCTHE ROAD
KIRKLAND, OH 44094

R

CAGE code: 2X146 1/

ROSAN PRODUCTS
AFS TORRANCE OPERATIONS
3018 WEST LOMITA BLVD.
TORRANCE, CA 90505-5103

(Corporate office see ALCOA FASTENING SYSTEMS)

RI

CAGE code: 83324 1/

1/ Information published in this revision was verified by direct contact with manufacturers.

2/ Information not verified to be current, no response from manufacturer. Information identical to that published in MIL-HDBK-57, Revision B.

ROTAIR INDUSTRIES, INC.
P.O. BOX 4098
964 CRESCENT AVE
BRIDGEPORT, CT 06607-1025



Rubber stamped
on fasteners

54878

Commercial and Government Entity
(CAGE) number affixed or rubber

CAGE code: 54878 1/

RS MANUFACTURING, INC.
INDUSTRIAL PARK BLVD.
MENTOR, OH 44060

RS 

CAGE code: 0MYK3 2/

RUDOLPH INSTRUMENTS, INC.
400 MORRIS AVE STE 120
DENVER, NJ 07834-1362

RI

CAGE code: 23262 2/

RUMCO, INC.
985 PAULY DR.
ELK GROVE VILLAGE, IL 60007-1312

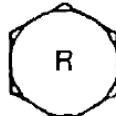

GRADE 2



GRADE 5



GRADE 5.1



GRADE 5.2



GRADE 8

CAGE code: 6Z992 2/

RUSCOMB TOOL & MACHNE CO., INC.
500 W. RUSCOMB STREET
PHILADELPHIA, PA 19120



RTM

CAGE code: 07952 2/

S & L METAL PRODUCTS CORP.
5829 57TH DR
MASPETH, NY 11378-2232

S&L

CAGE code: 05722 2/

1/ Information published in this revision was verified by direct contact with manufacturers.

2/ Information not verified to be current, no response from manufacturer. Information identical to that published in MIL-HDBK-57, Revision B.

<p>S. B. E. (ITALY CORPORATION) VIA ENRICO DERMI 20019 SETTIMO MILANESE, ITALY</p> <p style="text-align: center;">SBE</p> <p>CAGE code: _____ ^{2/}</p>
<p>S.A.B.A. S.p.A. BULLONERIA E. AFFINI VIA LIGURIA 11/13, 20098 SESTO ULERIANO FRAZ. DI S. GUILLANO M.SE MILANO, ITALY</p> <p style="text-align: center;">A.L.</p> <p>CAGE code: _____ ^{2/}</p>
<p>S.I. STUD, INC. 1127 SILBER RD. HOUSTON, TX 77055</p> <p style="text-align: center;">  </p> <p>CAGE code: _____ ^{2/}</p>
<p>SABRE MANUFACTURING, INC. P.O. BOX 11386 201 S. CHERRY ST. SOUTH BEND, IN 46601</p> <p style="text-align: center;">S</p> <p>CAGE code: 0GN74 _____ ^{2/}</p>

SAFETY SOCKET SCREW CORP.
(ENGINEERING DEPARTMENT)
6501 NORTH AVONDALE AVE.
CHICAGO, IL 60631

INCH SOCKET HEAD CAP SCREWS

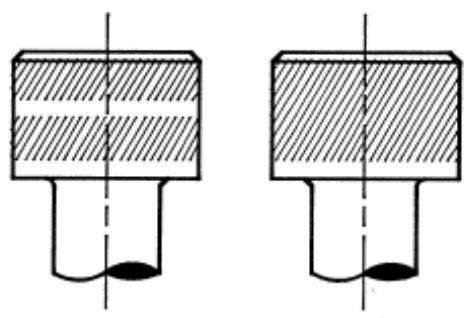

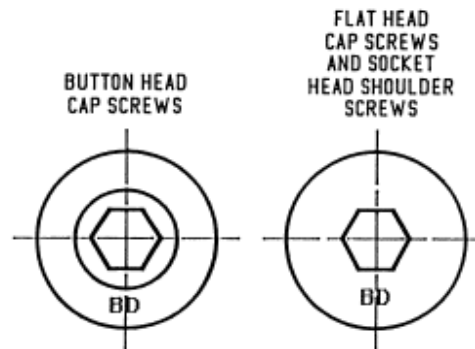

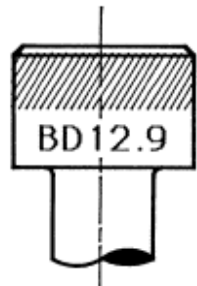







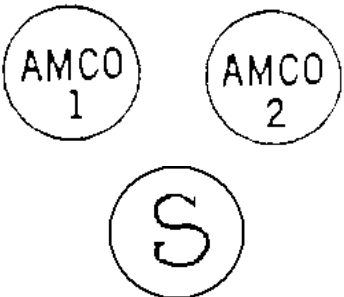

"BD" AND THE 60° DIAGONAL KNURL ARE REGISTERED TRADEMARKS OF SAFETY SOCKET SCREW CORPORATION FOR THE PURPOSE OF MANUFACTURERS IDENTIFICATION

BD BDM

CAGE code: 82896 _____ ^{2/}

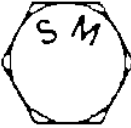
1/ Information published in this revision was verified by direct contact with manufacturers.
 2/ Information not verified to be current, no response from manufacturer. Information identical to that published in MIL-HDBK-57, Revision B.

<p>SAGA TEKKOSHO CO., LTD. 129-3 TAKAYA FUJISAWA-CITY KANAGAWA PREF., JAPAN</p>  <p>CAGE code: <u>2/</u></p>	<p>SANDIK MANUFACTURING, INC. 100 8TH STREET PASSAIC, NJ 07055</p>  <p>CAGE code: 6U704 <u>2/</u></p>
<p>SAI INDUSTRIES CORP. 1207 FULTON AVENUE SAN ANTONIO, TX 78201-4501</p>  <p>CAGE code: 1KQ10, 63095 <u>2/</u></p>	<p>SANNOHASHI SEISAKUSHO CO., LTD. 2-1-18 OKINO ADACHI-KU TOKYO 123 JAPAN</p>  <p>CAGE code: <u>2/</u></p>
<p>SALES SYSTEM, LIMITED P.O. BOX 7006 700 FLORIDA AVE. PORTSMOUTH, VA 23707-1918</p>  <p>CAGE code: 8F411 <u>1/</u></p>	<p>SANTA ANA GEAR & MACHINE 15201 PIPELINE LN. HUNTINGTON BEACH, CA 92649</p>  <p>CAGE code: <u>2/</u></p>
<p>SAMUEL MARSDEN & SON WELLINGTON RD. ASHTON UNDER LYNE, LANCASHIRE OL6 7EG UNITED KINGDOM</p>  <p>CAGE code: <u>2/</u></p>	<p>SANTA ANA SCREW PRODUCTS INC. SANTA ANA, CA 92701</p>  <p>CAGE code: 33644 <u>2/</u></p>

^{1/} Information published in this revision was verified by direct contact with manufacturers.

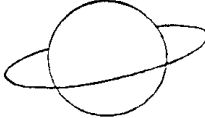
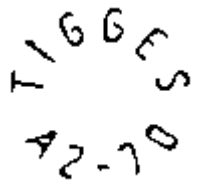

^{2/} Information not verified to be current, no response from manufacturer. Information identical to that published in MIL-HDBK-57, Revision B.

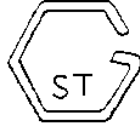
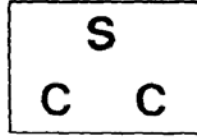

<p>SATAIR MANUFACTURING FACILITY PURDEYS WAY PURDEYS INDUSTRIAL ESTATE ROCHFORD ESSEX SS5 4JJ UK</p> <p style="text-align: center;">SMF</p> <p>CAGE code: K4975 <u>1/</u></p>
<p>SATURN FASTENERS, INC. 425 SO. VARNEY ST. BURBANK, CA 91502-2125</p> <p style="text-align: center;"></p> <p>CAGE code: 0K6Z0 <u>1/</u></p>
<p>SCANDIA MFG. CO., INC. 480 BRUNSWICK ST. BALTIMORE, MD 21223-2745</p> <p style="text-align: center;">SCA</p> <p>CAGE code: 00997 <u>1/</u></p>
<p>SCHMICO GMBH SCHWEISSTECHNIK P. O. BOX 12 29 PETER-LINNARTZ-STRASSE JUELICH 52428, GERMANY</p> <p style="text-align: center;"></p> <p>CAGE code: C15191 <u>2/</u></p>

<p>SCHRAUBENFABRIK GUSTAV STERNBERG GmbH & CO. KG 1000 BERLIN 27 BREITENBACHSTRASSE 11-12 GERMANY</p> <p style="text-align: center;"></p> <p style="text-align: center;">Symbol may be raised or struck in.</p> <p>CAGE code: <u>2/</u></p>
<p>SCHUHL & CO. GMBH AUF DER HUTTE 31 WINTERBURG 59955 GERMANY</p> <p style="text-align: center;">S</p> <p>CAGE code: C3639 <u>2/</u></p>
<p>SCOTT CRAFT CO. P.O. BOX 430 BELL, CA 90201</p> <p style="text-align: center;">Plant 4601 CECELIA STREET CUDAHY, CA 90201</p> <p style="text-align: center;"></p> <p>CAGE code: 28418 <u>2/</u></p>

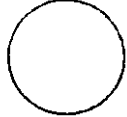
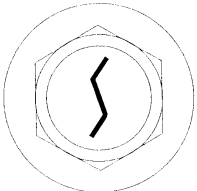
1/ Information published in this revision was verified by direct contact with manufacturers.

2/ Information not verified to be current, no response from manufacturer. Information identical to that published in MIL-HDBK-57, Revision B.





<p>SCREWCORP. (A DIVISION OF VSI) 13001 EAST TEMPLE AVE. CITY OF INDUSTRY, CA 91714</p>  <p>Indented circle on all fasteners, except machine screws.</p> <p>CAGE code: 9H901 2/</p>
<p>SEMBLEX CORP. 199 W. DIVERSEY AVE ELMHURST, IL 60126</p>  <p>CAGE code: 4M343 1/</p>
<p>SEMCO FASTENER 4146 EAST BALDWIN RD. HOLLY, MI 48442</p> <p>See RING SCREW WORKS</p>  <p>CAGE code: 0B2C8 1/</p>
<p>SENG HENG ENGINEERING PTE LTD. NO. 3 EUNOS AVE. 8A SINGAPORE 409458 REPUBLIC OF SINGAPORE</p>  <p>CAGE code: 1/</p>

<p>SESCO INDUSTRIES, INC. P. O. BOX 242 110 - 19 15TH AVENUE COLLEGE POINT, NY 11356</p>  <p>CAGE code: 0KH97 1/</p>
<p>SHACKELFORD MACHINIG, INC. 2407 LUDELLE ST. FORT WORTH, TX 76105-0755</p>  <p>CAGE code: 4K446 1/</p>
<p>SHAMROCK FASTENER TECHNOLOGIES, LLC. 6125 18 MILE ROAD STERLING HEIGHTS, MI 48314</p> <p>SHAMROCK IN CIRCLE</p>  <p>GRADE DESIGNATION</p> <p>SFT LDGO</p>  <p>GRADE DESIGNATION</p> <p>CAGE code: 05CF6 2/</p>

1/ Information published in this revision was verified by direct contact with manufacturers.

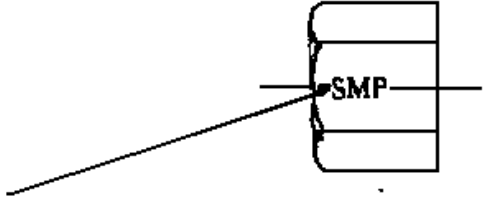
2/ Information not verified to be current, no response from manufacturer. Information identical to that published in MIL-HDBK-57, Revision B.

<p>SHAW PRECISION GRINDING & THREADING 6503 W. FRYE RD. SUITE 6 CHANDLER, AZ 85226</p> <p>SALES ADDRESS SEE: ACE GRINDING & MFG. OF TEXAS 2610 AERO DR. GRAND PRAIRIE, TX 75052 CAGE code: 5U074</p> <p style="text-align: center;">SPG</p> <p>CAGE code: 1KRG8 <u>1/</u></p>
<p>SHEFFIELD, INC. 1025 WINCHESTER AVE. KANSAS CITY, MO 64126</p> <p style="text-align: center;">S</p> <p>CAGE code: 68567 <u>2/</u></p>
<p>SHIGA BOLT CO., LTD. OTSU 423 MINAMI-TSUCHIYAMA TSUCHIYAMA-CHO, KOHGA-GUN SHIGA- KEN 528-02 JAPAN</p> <p style="text-align: center;"></p> <p>CAGE code: <u>2/</u></p>

<p>SHORELINE MACHINE PRODUCTS, INC. 19301 ST. CLAIR AVENUE CLEVELAND, OH 44117</p> <p style="text-align: center;"></p> <p>SMP will be applied to this surface to denote Shoreline Machine Products as manufacturer.</p> <p>CAGE code: 1VN42 <u>1/</u></p>
<p>SHUR-KUT SUPPLY CORPORATION 7 MT. PLEASANT DR. ASTON, PA 19014</p> <p style="text-align: center;"></p> <p>CAGE code: 6R002 <u>1/</u></p>
<p>SHUR-LOK COMAPNY. (SPS FASTENERS DIVISION , A PCC COMPANY) 2541 WHITE ROAD IRVINE, CA 92614 - 6235</p> <p style="text-align: center;"> </p> <p style="text-align: center;"></p> <p>CAGE code: 97393 <u>1/</u></p>

1/ Information published in this revision was verified by direct contact with manufacturers.

2/ Information not verified to be current, no response from manufacturer. Information identical to that published in MIL-HDBK-57, Revision B.

SIERRA PACIFIC SUPPLY CO., INC.
 P. O. BOX 4848
 COMPTON, CA 90224

Plant:
 1801 W EL SEGUNDO BLVD
 COMPTON, CA 90224



CAGE code: 5G098 1/

SIERRACIN/HARRISON
 3020 EMPIRE AVENUE
 BURBANK, CA 91504



CAGE code: 08199 2/

SIMMONDS PRODUCTS
 AFS ST. COSME OPERATIONS
 9 RUE DES CRESSONNIERES
 72110 ST. COSME-EN-VAIRAIS
 FRANCE

(Corporate office see ALCOA FASTENING SYSTEMS)



CAGE code: F0224 1/

SINN-TECH, INC.
 48 GLEAM STREET
 WEST BABYLON, NY 11704



CAGE code: 9J550 1/

SKY MANUFACTURING
 5989 RICCKENBACKER ROAD
 COMMERCE, CA 90040



CAGE code: 1CNU4 1/

SKYLINE INDUSTRIES
 1201 FORUM WAY SOUTH
 FORT WORTH, TX 76140





CAGE code: 09986 2/



SKYSPARES PARTS, INC.
 6660 VIEW PARK COURT
 RIVERSIDE, CA 92503

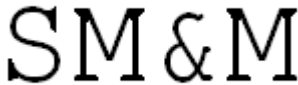

CAGE code: 6M132 2/



1/ Information published in this revision was verified by direct contact with manufacturers.
 2/ Information not verified to be current, no response from manufacturer. Information identical to that published in MIL-HDBK-57, Revision B.

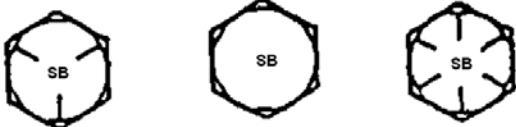

<p>SLABE MACHINE PRODUCTS 4659 HAMANN PARKWAY WILLOUGHBY, OH 44094</p>  <p>CAGE code: 97139 1/</p>
<p>SMITH MACHINE & MANUFACTURING RT. 4 P.O. BOX 283 CANTON, TX 75103</p>  <p>CAGE code: 0MAJO 2/</p>
<p>SMITH WELDING, INC. 756 PRUNNER ROAD RIDDLE, OR 97469</p>  <p>CAGE code: 1GQX1 1/</p>

<p>SONFARREL, INC. 3000-3010 LA JOLLA ST. ANAHEIM, CA 92806</p>  <p>CAGE code: 09036 2/</p>
<p>SONIC INDUSTRIES, INC. 20030 SO. NORMANDIE AVE. TORRANCE, CA 90502</p>  <p>CAGE code: 57928 1/</p>
<p>SOUTH BAY BOLT MANUFACTURING CO. P.O. BOX 5805 COMPTON, CA 90224</p> <p>Plant 1775 W. El Segundo Blvd. Compton, CA 90222</p>  <p>CAGE code: 2P339 2/</p>

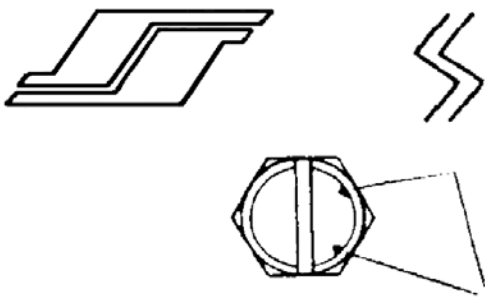
1/ Information published in this revision was verified by direct contact with manufacturers.

2/ Information not verified to be current, no response from manufacturer. Information identical to that published in MIL-HDBK-57, Revision B.

<p>SOUTHERN FASTENER CORPORATION P. O. BOX 1387 1641 CONCEPTION STREET ROAD MOBILE, AL 36610</p> <p style="text-align: center;">SF</p> <p>CAGE code: 1K461 <u>1/</u></p>
<p>SOUTHERN FASTENING SYSTEMS (DIVISION OF FARLEY METALS, INC.) P.O. BOX 1360 STATESVILLE, NC 28677</p>  <p style="text-align: center;"><i>2 notches for slotted heads only</i></p> <p>CAGE code: 87308 <u>2/</u></p>
<p>SOUTHWEST ALLIED PRODUCTS CO., INC. 299 HILL RD. VANLEER, TN 37181</p>  <p>CAGE code: 6P461 <u>2/</u></p>

<p>SOUTHWEST INDUSTRIAL SERVICES P. O. BOX 9084 FT. WORTH, TX 76147</p> <p style="text-align: center;">Plant 2413 WHITMORE FT. WORTH, TX 76147</p> <p style="text-align: center; font-size: 2em;">SI</p> <p>CAGE code: 6H920 <u>2/</u></p>
<p>SOUTHWIND INDUSTRIES, INC. P.O. BOX 98 1646 OILD BUTLER PLANK RD. PITTSBURGH, PA 15200</p>  <p>CAGE code: 0DTJ0 <u>2/</u></p>
<p>SPACE AGE ENGINEERING, INC. 4022 E. 26TH STREET INDIANAPOLIS, IN 46218</p>  <p>CAGE code: 29953 <u>2/</u></p>
<p>SPACE SCREW, INC. 106 STANDARD ST. EL SEGUNDO, CA 90245</p> <p style="text-align: center; font-size: 2em;">SpSc</p> <p>CAGE code: 0GE51 <u>2/</u></p>

1/ Information published in this revision was verified by direct contact with manufacturers.

2/ Information not verified to be current, no response from manufacturer. Information identical to that published in MIL-HDBK-57, Revision B.

<p>SPACE-LOK, INC. 13306 HALLDALE AVE. GARDENA, CA 90249</p> <p style="text-align: center;">SLI</p> <p>CAGE code: 16258 <u>1/</u></p>
<p>SPARTAN PRECISION MACHINE 131 ALBANY AVE FREEPORT, NY 11520</p> <p style="text-align: center;"></p> <p>CAGE code: 2M198 <u>2/</u></p>
<p>SPECIALS, INC. P.O. BOX 514 103 MAINLINE DRIVE WESTFIELD, MA 01086-0514</p> <p style="text-align: center;"></p> <p>CAGE code: 0WVC1 <u>1/</u></p>

<p>SPECIAL-T-METALS P.O. BOX 14810 LENEXA, KS 66215</p> <p style="text-align: center;">Plant 14740 WEST 101 TERRACE LENEXA, KS 66215</p> <p style="text-align: center;">STM</p> <p>CAGE code: 8U495 <u>2/</u></p>
<p>SPECIALTY SCREW CORP. P.O. BOX 5003 ROCKFORD, IL 61125</p> <p style="text-align: center;">Plant 2801 HUFFMAN BLVD. ROCKFORD, IL 61103</p> <p style="text-align: center;">S</p> <p>CAGE code: 1WQE5 <u>2/</u></p>
<p>SPIRAL TOOL CORP. 761 ROUTE 6 SHOHOLA, PA 18458</p> <p style="text-align: center;"></p> <p>CAGE code: 02108 <u>1/</u></p>

1/ Information published in this revision was verified by direct contact with manufacturers.

2/ Information not verified to be current, no response from manufacturer. Information identical to that published in MIL-HDBK-57, Revision B.

SPS TECHNOLOGIES
FASTENER DIVISION CORPORATE
HEADQUARTERS
JENKINTOWN, PA 19046-2630

SPS AREOSPACE FASTENER COPANIES

SPS TECHNOLOGIES (Cage 56878)
301 HIGHLAND AVENUE
JENKINTOWN, PA 19046-2630

The following characters (used alone or in combination with other digits/ letters which designate material, size, strength grade or part number) indicate SPS as manufacturing source:

C	K	U
CCS	K-5673	U130
EWB	KS	UNBRAKO
EWN	S	UNW
FNF	SPS	56878
HI PSI	TJB	71838
HI TI	TM9	80539

For "inch" socket head cap screws

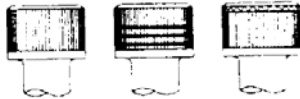

Straight knurls with an unknurled band adjacent to the bearing surface on socket heads. The diameter over the straight knurl does not exceed the band. There may be 2 or 3 grooves near the band or a diamond knurl band at top of head.



A raised or depressed triangle pointing from the wrenching flat toward thread on nut products.



S-C used on metal nuts

SPS TECHNOLOGIES (Cage 80539)
SANTA ANA DIVISION
271 SO. HARBOR BLVD.
SANTA ANA, CA 92704-1259

SPS SPS S S

CAGE code: 56878, 80539, 1/
Continued

Continued

SPS TECHNOLOGIES (Cage K5673)
T. J. BROOKS DIVISION
191, BARKBY ROAD'
TROON INDUSTRIAL AREA
LEICESTER LE4 9HX
ENGLAND



SPS ENGINEERED PRODUCTS GROUP

SPS TECHNOLOGIES (Cage 1C5D9)
NORTH AMERICAN FASTENERS
(AFG DIV)
4444 LEE ROAD
CLEVELAND, OH 44128-2902



SPS TECHNOLOGIES (Cage 495T1)
NORTH AMERICAN FASTENERS
DBA TERRY MACHINE
5331 DIXIE HWY
WATERFORD, MI 48329



SPS TECHNOLOGIES (Cage U3575)
P O BOX 38
BURNABY ROAD
COVENTRY CV 6 AE, ENGLAND

SPS INTERNATIONAL LTD. (Cage S3329)
UNBRACO SHANNON
BAYS 25-30 SHANNON INDUSTRIAL
ESTATE,
SHANNON, COUNTRY CLARE,
IRELAND

METALAC SPS INDUSTRIA E COMERCIO
LTDA.
AVENIDA ITAVUVU, 4690
18078-005 SOROCABA (SP),
BRAZIL

TELLEP TLP T 

UNBRACO PTY LTD. AUSTRALIA
P.O. BOX 3138 NUNAWADING
VICTORIA 3131, AUSTRALIA

U UM

CAGE code: K5673, IC5D9, 495T1, U3575,
S3329 1/

1/ Information published in this revision was verified by direct contact with manufacturers.

2/ Information not verified to be current, no response from manufacturer. Information identical to that published in MIL-HDBK-57, Revision B.

<p>SPS TECHNOLOGIES LIMITED T/A UNBRACO UK CRANFORD STREET SMETHWICK B66 2TA UNITED KINGDOM</p> <p style="text-align: center;">TBJ</p> <p>CAGE code: U3575</p> <p>SPS TECHNOLGOIES LIMITED TJ BROOKS DIVISION (UNITED KINGDON CORPORATION)) 191 BARKBY ROAD TROON INDUSTRIAL AREA LEICESTER LE4 9HX UNITED KINGDOM</p> <p style="text-align: center;">TBJ</p> <p>CAGE code: K5673 <u>2/</u></p>	<p>SRI SAI INDUSTRIES CORPORATION 1207 FULTON AVENUE SAN ANTONIO, TX 78201-5104</p> <p style="text-align: center;"></p> <p>CAGE code: 63095 <u>1/</u></p> <hr/> <p>ST. LOUIS SCREW & BOLT CO. 6900 NORTH BROADWAY ST. LOUIS, MO 63147</p> <p style="text-align: center;"></p> <p style="text-align: center;">TYPE I</p> <p style="text-align: center;"></p> <p style="text-align: center;">TYPE III</p> <p>CAGE code: <u>2/</u></p>
<p>SPURWAY COOKE INDUSTRIES PTE LTD. 2, JOO KOON ROAD JURONG SINGAPORE 628966 REPUBLIC OF SINGAPORE</p> <p style="text-align: center;"></p> <p>CAGE code: <u>1/</u></p>	<p>STALKER & DYSTHE, INC. 5100 E. WASHINGTON BLVD. LOS ANGELES, CA 90040</p> <p style="text-align: center;">SD</p> <p>CAGE code: 6D696 <u>2/</u></p>

1/ Information published in this revision was verified by direct contact with manufacturers.

2/ Information not verified to be current, no response from manufacturer. Information identical to that published in MIL-HDBK-57, Revision B.

<p>STANDARD LOCKNUT, INC. P. O. BOX 780 1045 EAST 169TH STREET WESTFIELD, INDIANA 46074</p> <p style="text-align: center;"></p> <p>CAGE code: 78507 <u>2/</u></p>
<p>STANDARD NUT & BOLT, INC. 49 ABBOTT ST. CUMBERLAND, RI 02864</p> <p style="text-align: center;"></p> <p>CAGE code: 758C9 <u>2/</u></p>
<p>STANDARD TOOL & MACHINE CO. 205 E. CARSON ST. PITTSBURGH, PA 15219</p> <p style="text-align: center;">Plant 208 WOODLAND RD. BIAWNOX, PA 15238</p> <p>See HALL INDUSTRIES</p> <p style="text-align: center;"></p> <p>CAGE code: 0KA69 <u>2/</u></p>
<p>STEADFAST CORPORATION 229 MARGINAL ST. CHELSEA, MA 02150</p> <p style="text-align: center;"></p> <p>CAGE code: 9X854 <u>2/</u></p>

<p>STEEL CITY BOLT & SCREW, INC. P.O. BOX 1747 BIRMINGHAM, AL 35201</p> <p style="text-align: center;">Plant 230 WEST VALLEY AVE. BIRMINGHAM, AL 35209</p> <p style="text-align: center;"></p> <p>CAGE code: 3N642 <u>2/</u></p>
<p>STEEL PRODUCTS OF MASSILLION 132 WALNUT RD S.W. MASSILLION, OH 44646</p> <p style="text-align: center;"></p> <p>CAGE code: 0698X <u>2/</u></p>
<p>STEEL WAREHOUSE COMPANY, INC. 2722 WEST TUCKER DRIVE BOX 1377 SOUTH BEND, IN 46624</p> <p style="text-align: center;"></p> <p>CAGE code: 0R1J8 <u>2/</u></p>

1/ Information published in this revision was verified by direct contact with manufacturers.

2/ Information not verified to be current, no response from manufacturer. Information identical to that published in MIL-HDBK-57, Revision B.

STELCO FASTENER & FORGING CO.
 1250 APPLEBY LINE
 BULINGTON, ONTARIO L71 5G6
 CANADA



Stelco trademark
for most
fasteners



Most other nuts
and bolts,
including metric



SAE Grade 5
hex nuts



SAE Grade 8
hex nuts

CONELOK LOCKNUTS
Inch series





Grade B



Grade C

Metric series

Class 5 Class 9 Class 10

Bearing surface

CAGE code: _____

Continued 2/

Continued

STELCO FASTENER & FORGING CO.
 1250 APPLEBY LINE
 BULINGTON, ONTARIO L71 5G6
 CANADA

HI-HEX CONELOK LOCKNUTS
Inch series



Grade B



Grade C

Metric series

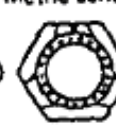
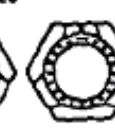



Class 5 Class 9 Class 10

Bearing surface

CAGE code: _____ 2/

STELFAST FASTENERS, INC.
 (DIVISION OF STELFAST FASTENERS,
 LTD.)
 1710 CLARKSTONE ROAD
 CLEVELAND, OH 44112



1/4 in. through 3/4 in. hex cap
screws, heavy hex bolts, square
head bolts, and specialty exter-
nally threaded fasteners, cold
headed.



3/4 in. through 2 1/4 in. reg. hex
bolts, heavy hex bolts, square
head bolts, and specialty exter-
nally threaded fasteners, hot
headed.



1/4 in. through 2 1/2 in. studs.



2 3/8 in. through 3 in. reg. hex
bolts, heavy hex bolts, square
head bolts, hot headed, and
specialty externally threaded
fasteners.

CAGE code: _____ 2/

1/ Information published in this revision was verified by direct contact with manufacturers.

2/ Information not verified to be current, no response from manufacturer. Information identical to that published in MIL-HDBK-57, Revision B.

STERLING MACHINE COMPANY
23 FARRAR STREET
LYNN, MA 01901-1699

2

SC

CAGE code: 03983 1/

STERLING MARKING PRODUCTS IC
P.O. BOX 3360 STA A
349 RIDOUT ST N
LONDON, ONTARIO, CANADA NGA 4K3

GD

IGD

CAGE code: 37084 2/

STERLING MFG. & SUPPLY, INC.
P.O. BOX 8205
FORT WORTH, TEXAS 76124

Plant
3623 E. VICKERY BLVD.
FORT WORTH, TX 76105

S or **60529**

Steel stamped
or
Embossed
or
Rubber stamped

CAGE code: 60529 2/

STEVENS MFG. CO., INC.
P.O. BOX 3041
MILFORD, CT 06460

Plant
280 ROCK LANE
MILFORD, CT 06460

MFR 8F781

8F781

CAGE code: 8F781 2/

STILLWATER FASTENERS, INC.
25 GURNEY ROAD
EAST FREETOWN, MA 02717-1107

SW & ..

Symbols are "SW", ampersand ("&") or "..."

CAGE code: 1Y153 1/

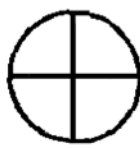

STRENKERT MACHINE SHOP INC.
RD #2, BOX 759
INDIAN BROOK ROAD
GREENE, NY 13778



CAGE code: 2T174 2/

1/ Information published in this revision was verified by direct contact with manufacturers.

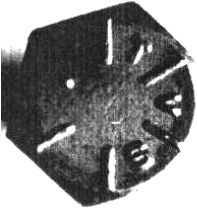
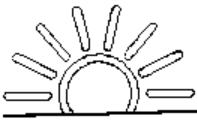

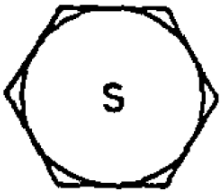
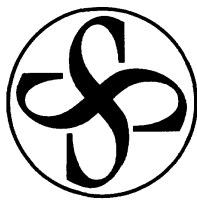
2/ Information not verified to be current, no response from manufacturer. Information identical to that published in MIL-HDBK-57, Revision B.

<p>STURM MACHINE CO., INC. 9846 OWENSMOUTH AVE. CHATSWORTH, PA 91311</p>  <p>CAGE code: 64733 <u>2/</u></p>	<p>SUNDRAM FASTENERS, LTD. MADRAS, INDIA</p>  <p>CAGE code: <u>2/</u></p>
<p>SUBCON TOOL/ACCUTOOL MACHINE GROUP INC. (DBA ACCUTOOL) 5301 IROQUOIS AVE ERIE, PA 16511 - 2529 See ACCUTOOL</p> <p style="font-size: 2em; text-align: center;">01FO</p> <p>CAGE code: 1UMX0 <u>1/</u></p>	<p>SUNRISE PRECISION MFG. 4406 ENTERPRISE PL, UNIT 3 FREMONT, CA 94538</p>  <p>CAGE code: 0UK47 <u>2/</u></p>
<p>SUBURBAN INDUSTRIES, INC. 11901 FRANKLIN AVE FRANKLIN PARK, IL 60131</p> <p style="font-size: 2em; text-align: center;">SII</p> <p>CAGE code: 89752 <u>2/</u></p>	<p>SUPERIOR TECHNOLOGY 11013 OLINDA STREET SUN VALLEY, CA 91352</p>  <p style="text-align: center;">EARTH</p> <p>CAGE code: <u>2/</u></p>
<p>SULLIVAN BOLT CO., INC. 3435 SOUTH MALT AVE. COMMERCE, CA 90040</p>  <p>CAGE code: 6M158 <u>2/</u></p>	<p>SUPREME SCREW PRODUCTS, INC. 1368 CROMWELL AVENUE BRONX, NY 10452</p>  <p>CAGE code: 1FMQ2 <u>2/</u></p>

^{1/} Information published in this revision was verified by direct contact with manufacturers.

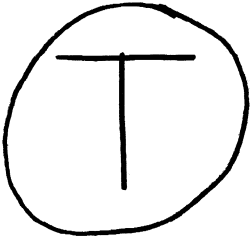
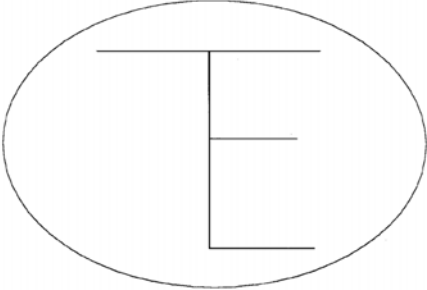

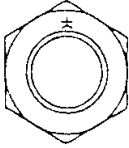



^{2/} Information not verified to be current, no response from manufacturer. Information identical to that published in MIL-HDBK-57, Revision B.

<p>S V INDUSTRIES 29280 YNEZ RD. TEMECULA, CA 92592</p> <p style="text-align: center;">SV</p> <p>CAGE code: OGVY7 <u>2/</u></p>
<p>SWISS TECHNOLOGY, INC. 9 BRIDEWELL PL. CLIFTON, NJ 07014</p> <p style="text-align: center;"></p> <p>CAGE code: 48406 <u>1/</u></p>
<p>T & E MACHINE CORP. 4519C WAYNE AVENUE PHILADELPHIA, PA 19144-3606</p> <p style="text-align: center;"> </p> <p>CAGE code: 059P5 <u>2/</u></p>

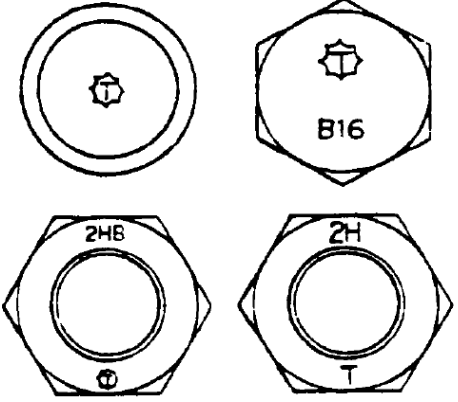
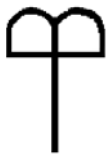
<p>T C QUALITY MACHINING INC. 12155 MAGNOLIA AVE STE 10D RIVERSIDE, CA 92503 - 4905</p> <p style="text-align: center;">TCQ</p> <p>CAGE code: 3H5W3 <u>1/</u></p>
<p>T R MACHINE INC. 103 STATE ROUTE 75 E DAVIS, IL 61019-9586</p> <p style="text-align: center;">TR</p> <p>CAGE code: 1YJV1 <u>1/</u></p>
<p>TAIYO NUT MFG. CO., LTD. 2-6-12 KOUZEN, IKARUGACHO IKOMA-GUN, NARA, JAPAN</p> <p style="text-align: center;"> </p> <p>CAGE code: <u>2/</u></p>

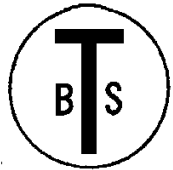
1/ Information published in this revision was verified by direct contact with manufacturers.

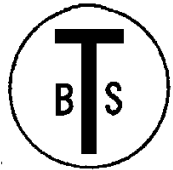
2/ Information not verified to be current, no response from manufacturer. Information identical to that published in MIL-HDBK-57, Revision B.

<p>TAKENAKA SEISAKUSHO CO., LTD. 178 HISHIE HIGASHI OSAKA CITY, JAPAN 578</p>  <p>CAGE code: <u>2/</u></p>	<p>TEBCO THREADED FASTENERS (DIVISION OF TENNESSEE BOLT & SCREW CO.) 2700 SUMMER AVENUE MEMPHIS, TN 38112</p> <p>Plant 665 SCOTT STREET MEMPHIS, TN 38112</p>  <p>CAGE code: 4K536 <u>2/</u></p>
<p>TANAKA LTD. 1-10-6 TEZUKAYAMA-NAKA SUMIYOSHI-KU, OSAKA, JAPAN</p>  <p>CAGE code: SP833 <u>2/</u></p>	<p>TECH WELDING AND MACHINE CO. 41 KINGSTON AVENUE COLUMBUS, OH 43207</p>  <p>CAGE code: 9Y179 <u>2/</u></p>
<p>T-B & S MFG. 4404 GARLAND DRIVE FORT WORTH, TX 76117</p>  <p>CAGE code: <u>2/</u></p>	<p>TECHNICAL FASTENERS, INC. 1129 GRIMMITT DR SHREVEPORT, LA 71107</p>  <p>CAGE code: 0GV34 <u>2/</u></p>
<p>T-B & S MFG. 4404 GARLAND DRIVE FORT WORTH, TX 76117</p>  <p>CAGE code: <u>2/</u></p>	<p>TEK PRECISION CO., LTD. 205 WEST INDUSTRY COURT DEER PARK, NY 11729</p>  <p>CAGE code: 65780 <u>1/</u></p>

1/ Information published in this revision was verified by direct contact with manufacturers.

2/ Information not verified to be current, no response from manufacturer. Information identical to that published in MIL-HDBK-57, Revision B.

TELEFAST INDUSTRIES, INC.
777 W BAGLEY RD
BEREA, OH 44017-2901

T



TF

CAGE code: 3CW33 1/

TENS MACHINE CO., INC.
800 GRUNDY AVE.
HOLBROOK, NY 11741-2606



TENS

CAGE code: 8P689 1/

TERRY MACHINE CO.
P.O. BOX 487
5331 DIXIE HWY.
WATERFORD, MI 48095-1

See SPS TECHNOLOGIES



CAGE code: 87880 2/

TERRYCABLE, INC.
17376 EUCALYPTUS STREET
HESPERIA, CA 92345

TC

CAGE code: 0XZ68 2/

TEXAS BOLT CO.
P.O. BOX 1211
3235 W. 11TH ST.
HOUSTON, TX 77251



CAGE code: 27422 2/

TEXAS PRECISION MFG., INC.
P.O. BOX 3640
610 28TH ST
LUBBOCK, TX 79452

Plant
1204 E. 46TH STREET
LUBBACK, TX 79404

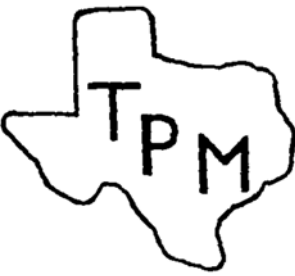

CAGE code: ICU57 2/

1/ Information published in this revision was verified by direct contact with manufacturers.
2/ Information not verified to be current, no response from manufacturer. Information identical to that published in MIL-HDBK-57, Revision B.

TEXTRON FASTENING SYSTEMS
 (AEROSPACE - SANTA ANA OPERATIONS)
 1224 E. WARNER AVENUE
 SANTA ANA, CA 92705

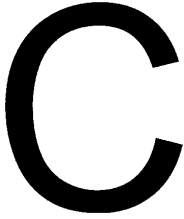

LOCKBOLTS
 Bold "C"

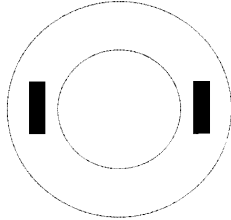

LOCKBOLT COLLARS
 Two Opposing Dashes

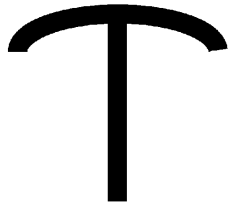

ALL PRODUCTS
 Lazy "T"

CAGE code: 11815

1/

TFI AEROSPACE CORPORATION
 19 CONSTELLATION CT.
 REXDALE, ONTARIO, CANADA



ALL NEW
 TOOLING



MODIFIED
 EXISTING
 TOOLING

CAGE code: L0336

2/

TFP CORP.
 (TRU-FIT PRODUCTS DIVISION)
 (SPECIAL FASTENER DIVISION)
 P. O. BOX 952
 MEDINA, OH 44258

Plant
 TRU-FIT STEEL WIRE CO.,LTD
 (TRU-WELD DIVISION)
 460 LAKE ROAD
 MEDINA, OH 44258

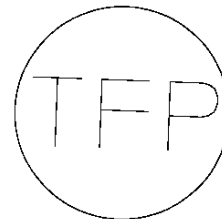
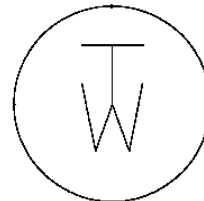
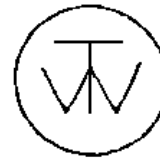

CAGE code: 31000

1/

1/ Information published in this revision was verified by direct contact with manufacturers.

2/ Information not verified to be current, no response from manufacturer. Information identical to that published in MIL-HDBK-57, Revision B.

THIANT (BOULONNERIE DE SA)
 B.P. 4
 FRANCE 59224



This marking appears on all hex nuts with or without deflection marks. The three raised lines in the corner indicate "Thiant" as manufacturer. (Clockwise system for grade.)



This marking appears on all flange nuts. The three raised lines on the flange indicate "Thiant" as manufacturer. (Clockwise system for grade.)



This marking appears on flange nuts when no mark is acceptable on the flange. Three depressed lines indicate "Thiant" as manufacturer. (Clockwise system for grade.)



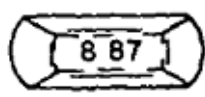

This marking appears on flange nuts when raised marks are not accepted. Three depressed lines indicate "Thiant" as manufacturer. (Clockwise system for grade.)

TRACKS FASTENERS



HIGH STRENGTH STRUCTURAL BOLT

HOT FORGED BOLTS

CAGE code: 2/

THOMAS & BETTS CORPORATION
 (FORMERLY AMERICAN ELECTRIC)
 8155 T AND B BLVD
 MEMPHIS, TN 38125 - 8888

Plant 1
 260 DENNIS STREET
 ATHENS, TN 37303

Plant 2
 8735 HAMILTON ROAD
 SOUTHAVEN, MS 38671

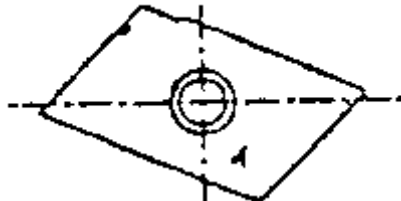

CAGE code: 56501 1/

THOMAS INSTRUMENT & MACHINE CO.,
 INC.
 3440 E FIRST ST
 BROOKSHIRE, TX 77423 - 0999



CAGE code: 5H860 2/

THOMAS MACHINING TECHNOLOGIES,
 INC.
 12 COUNT ROAD 486
 HANCEVILLE, AL 35077



CAGE code: 1VNC4 2/

1/ Information published in this revision was verified by direct contact with manufacturers.

2/ Information not verified to be current, no response from manufacturer. Information identical to that published in MIL-HDBK-57, Revision B.

THOMAS MFG, INC.
25125 W OUTER DR
MELVINDALE, MI 48122

THOMAS

CAGE code: 0NWS1 2/

TITAN FASTENER
10031 HOLLY ROAD
HOLLY, MI 48442

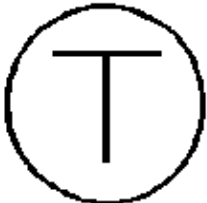

CAGE code: 2/

TOG MANUFACTURING CO., INC.
1454 SOUTH STATE STREET
NORTH ADAMS, MA 01247



CAGE code: 63649 1/

TOKOSHA METAL WORKS LTD.
NO. 7-22, 3-CHROME, NAKAGAMA-NISHI,
IKUNO-KU, OSAKA, JAPAN

TKS

CAGE code: 2/

TONG HWEI ENTERPRISE CO., LTD.
NO. 399 GANG YAN ROAD
GANG SHAN 820, KAOHSIUNG
TAIWAN, R.O.C.

THE

CAGE code: None 1/

TOOLEX, INC.
7570 MORLEY STREET
HOUSTON, TX 77061



CAGE code: 1W383 2/

TOPURA CO., LTD.
2050 YAJOI-CHO
HIGASHIOSAKA-SHI,
OSAKA, JAPAN 579

Plant
201 SOYA, HATANO,
KANAGAWA 257 JAPAN

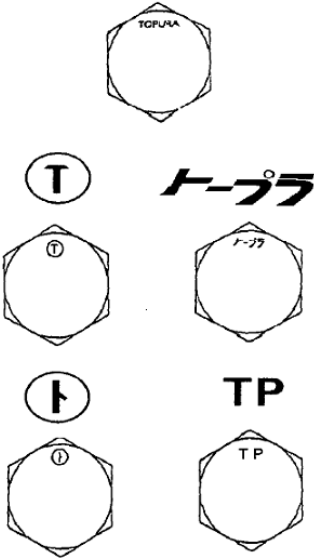

TOPURA





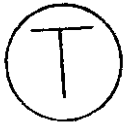

CAGE code: 2/

1/ Information published in this revision was verified by direct contact with manufacturers.

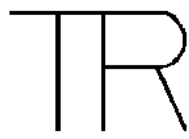

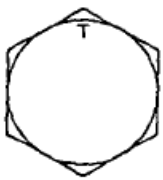
2/ Information not verified to be current, no response from manufacturer. Information identical to that published in MIL-HDBK-57, Revision B.

<p>TORCO, INC. P. O. BOX 4070 1330 OLD HIGHWAY 41 MARIETTA, GA 30061</p>  <p>CAGE code: 07359 <u>2/</u></p>
<p>TORONTO FASTENERS INDUSTRIES, INC. (SUBSIDIARY OF HI-SHEAR CORP., USA) 7475 KIMBEL ST., UNIT 8 MISSISSAUGA, ONTARIO L5S1E7</p> <p>See HI-SHEAR</p> <p>Plant 19 CONSTELLATION CT. REXDALE, ONTARIO, CANADA M9W 1K4</p>  <p>CAGE code: <u>2/</u></p>
<p>TORX PRODUCTS (CAMCAR DIVISION OF TEXTRON INC.) P. O. BOX 607 HWY 31 N. ROCHESTER, IN 46975</p> <p>For head markings see:</p> <p>CAMCAR Division of Textron, Inc. Plant TORX Products</p> <p>CAGE code: 6N040 <u>2/</u></p>

<p>TOWNE ROBINSON FASTENER CO. KEY MANUFACTURING GROUP, INC. P.O. BOX 232 24175 NORTHWESTERN HWY. SOUTHFIELD, MI 48037</p> <p>Plant 4401 WYOMING AVE. P.O. BOX 188 DEARBORN, MI 48121</p>  <p>CAGE code: 94678 <u>2/</u></p>
<p>TOWNSEND CO. CERRY RIVET DIVISION 1224 E. WARNER AVE. SANATA ANA, CA 92701</p> <p> Aircraft blind rivets.  Aircraft lockbolts.</p> <p>CAGE code: 7H092 <u>2/</u></p>
<p>TOYO STEEL WIRE CO., LTD. 3-9-45 TSURUHARA IZUMISANO-SHI, OSAKA, 598 JAPAN</p>   <p>CAGE code: <u>1/</u></p>

1/ Information published in this revision was verified by direct contact with manufacturers.

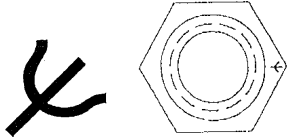
2/ Information not verified to be current, no response from manufacturer. Information identical to that published in MIL-HDBK-57, Revision B.

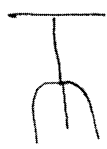
<p>TRI STATE TOOL & DIE CO. 1396 NORTON RD STOW, OH 44224-1333</p>  <p>BRAND AT ONE CORNER</p> <p>CAGE code: 06RM8 1/</p>
<p>TRIAD PRODUCTS CORP. 15241 N.E. 92ND REDMOND, WA 98052</p>  <p>CAGE code: 74468 2/</p>
<p>TRIDAIR PRODUCTS AFS TORRANCE OPERATIONS 3000 WEST LOMITA BLVD. TORRANCE, CA 90505-5103</p> <p>(Corporate office see ALCOA FASTENING SYSTEMS)</p>  <p>CAGE code: 29372 1/</p>
<p>TRIDENT MACHINE CO. 3491 N. MERIDIAN ROAD ROCKFORD, IL 61101</p>  <p>CAGE code: 5N818 1/</p>

<p>TRIUMPH GROUP OPERATIONS INC, THE (FRISBY AEROSPACE INC DE) 417 S. MAIN ST. FREEPORT, NY 11520-5144</p> <p>Ssee FRISBY AEROSPACE INC DE</p> <h1 style="text-align: center;">FAH</h1> <p>CAGE code: 26437 2/</p>
<p>TRIUMPH MANUFACTURING CO., INC. P.O. BOX 380148 750 TOLLAND ST. EAST HARTFORD, CT 06138</p> <h1 style="text-align: center;">TRI</h1> <p>CAGE code: 8X098 2/</p>
<p>TRONSON MANUFACTURING 45383 INDUSTRIAL PLACE #41 FREEMONT, CA 94538</p> <h1 style="text-align: center;">TM</h1> <p>CAGE code: 1DPK8 2/</p>
<p>TROY D. RAY DBA DIXON MACHINE & FABRICATION 6807 CHAPMAN HWY. KNOXVILLE, TN 37920-6560</p> <h1 style="text-align: center;">DMT</h1> <p>CAGE code: 1DEP3 2/</p>

1/ Information published in this revision was verified by direct contact with manufacturers.



2/ Information not verified to be current, no response from manufacturer. Information identical to that published in MIL-HDBK-57, Revision B.

TRW
(FASTENER DIVISION)
265 THIRD STREET
CAMBRIDGE, MA 02142

PAL

Logo Stampings Used on
Brass Snap Fastener Components

 Part No. 15100

  Part No. 16506

 Part Nos. 10412 and 10413

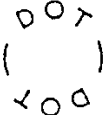
 Part No. 22201

 Part Nos. 10224, 12206, 10412, 10413, 10414, 90307

 Part Nos. 16205 and 16206

CAGE code: 83058 2/

TRY - AZTEC COMPANY
P.O. BOX 6191
TEHACHAPI, CA 93561

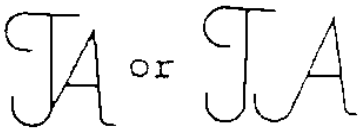

CAGE code: 2/

TUFF FASTENERS CO.
10724 GARWICK PLACE
SOUTH GATE, CA 90280-7332



CAGE code: 5V629 2/

TURNAMICS, INC.
92 NEW LIECHESTER HWY
ASHVILLE, NC 28806

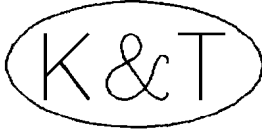

CAGE code: 1CWU8 2/

TW DESIGN AND MANUFACTURING, L.L.C.
P. O. BOX 310
33 WEST STREET
MONTELLO, WI 53949



CAGE code: 0X311 2/

TWIST TITE MFG. INC.
13649 PUMICE STREET
SANTA FE SPRINGS, CA 90670

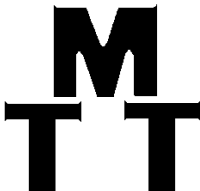

CAGE code: 007R1 1/

1/ Information published in this revision was verified by direct contact with manufacturers.



2/ Information not verified to be current, no response from manufacturer. Information identical to that published in MIL-HDBK-57, Revision B.

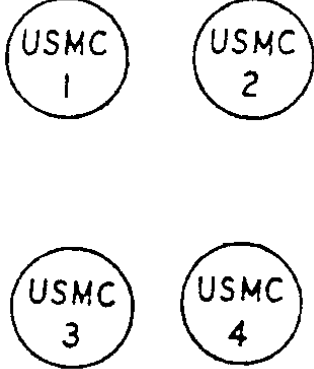

<p>U.P. MACHINE & ENGINEERING CO. P.O. BOX 400 210 NORTH THIRD STREET POWERS, MI 49874</p> <p style="text-align: center; font-size: 2em;">UPME</p> <p>CAGE code: 5H091 <u>2/</u></p>
<p>U.S. BOLT MANUFACTURING, INC. 12895 SOUTH MAIN HOUSTON, TX 77035</p> <p style="text-align: center; font-size: 2em;">S</p> <p>CAGE code: 0UZJ8 <u>2/</u></p>
<p>ULTIMATE MACHINING & WELDING 1003 ARGUELLO STREET REDWOOD CITY, CA 94063</p> <p style="text-align: center; font-size: 2em;">U M&W</p> <p>CAGE code: OXXP2 <u>2/</u></p>

<p>ULTRA SONIC MACHINE CO., INC. 1313 WEST 135TH STREET GARDENA, CA 90247</p> <p style="text-align: center;">  </p> <p>CAGE code: 4F713 <u>2/</u></p>
<p>UMPCO CORP. P.O. BOX 5158 7100 LAMPSON AVE. GARDEN GROVE, CA 92841</p> <p style="text-align: center; font-size: 2em;">MP</p> <p>CAGE code: 18076 <u>2/</u></p>
<p>UNIFLOW CORP. P.O. BOX 705 26600 HEYN DRIVE NEW HAVEN, MI 48050</p> <p style="text-align: center; font-size: 2em;">• R</p> <p>CAGE code: 4S622 <u>2/</u></p>

1/ Information published in this revision was verified by direct contact with manufacturers.

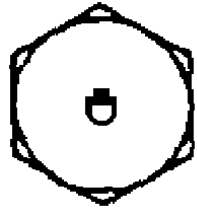

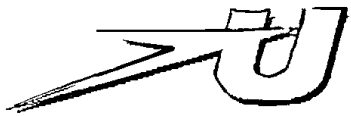
2/ Information not verified to be current, no response from manufacturer. Information identical to that published in MIL-HDBK-57, Revision B.

<p>UNIMETERIC CORPORATION P.O. BOX 4529 5 TRIPPS LANE EAST PROVIDENCE, RI 02915</p> <p style="text-align: center;">U</p> <p>CAGE code: 7U319 <u>2/</u></p>
<p>UNISTRUT CORP. (UNISTRUT PHILA) 761 FIFTH AVE KING OF PRUSSIA, PA 19406</p> <p style="margin-left: 40px;">Plant UNISTRUT CORP. WAYNE MFG. DIV. 35660 CLINTON WAYNE, MI 48184</p> <p style="text-align: center;">UNISTRUT </p> <p>CAGE code: 96195 <u>2/</u></p>
<p>UNITED BOLT & SCREW CORP. 1055 HAGGERTY AVE. DEARBORN, MI 48126</p> <p style="text-align: center;"> </p> <p>CAGE code: 8G949 <u>2/</u></p>

<p>UNITED DRILL BUSHING CORP. 12200 WOODRUFF AVE DOWNEY, CA 90241</p> <p style="text-align: center;"></p> <p>CAGE code: 52369 <u>2/</u></p>
<p>UNITED PRECISION PRODUCTS CO., INC. 25040 VAN BORN ROAD DEARBORN HEIGHTS, MI 48125</p> <p style="text-align: center;">UP</p> <p>CAGE code: 17328 <u>1/</u></p>
<p>UNITED STATES DEFENSE RESEARCH & SUPPLY 311 EASTRIDGE ROAD GRANDBURY, TX 76049</p> <p style="text-align: center;"></p> <p>CAGE code: 0XVD5 <u>2/</u></p>

1/ Information published in this revision was verified by direct contact with manufacturers.



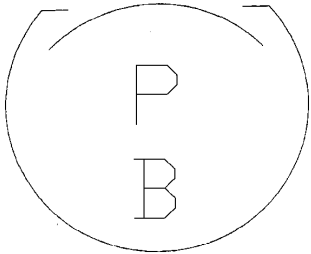

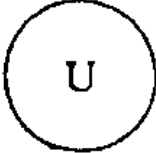
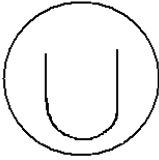



2/ Information not verified to be current, no response from manufacturer. Information identical to that published in MIL-HDBK-57, Revision B.

<p>UNITED STEEL & FASTENERS INC. 1500 INDUSTRIAL DRIVE ITASCA, IL 60143</p> <p style="text-align: center;">S^UF </p> <p>Identification used on all large bolts </p> <p>Identification used on all small bolts and on the shoulders of nuts </p> <p>CAGE code: 2R938 1/</p>
<p>UNIVERSAL MACHINE PRODUCTS 480 SURF AVENUE STRATFORD, CT 06497</p> <p style="text-align: center;">UM</p> <p>CAGE code: 0Y156 2/</p>
<p>UPB ENGINEERING 13060 TOM WHITE WAY "UNIT F" NORWALK, CA 90650</p> <p style="text-align: center;"></p> <p>CAGE code: 1BER9 2/</p>

<p>URANIA ENGINEERING CO., INC. SPEC-NUT® 198 SOUTH POPLAR STREET HAZLETON, PA 18201</p> <p style="text-align: center;"></p> <p>CAGE code: 30279 2/</p>
<p>URBAN MANUFACTURING CO. P.O. BOX 4260 100 W. BERKLEY ST PHILADELPHIA, PA 19144</p> <p style="text-align: center;"></p> <p>CAGE code: OW5R7 2/</p>
<p>URBAN MFG. CO. INC. P.O. BOX 1070 529 FORREST AVE. DREXEL HILL, PA 19026</p> <p style="text-align: center;"></p> <p>CAGE code: 9Y188 2/</p>





1/ Information published in this revision was verified by direct contact with manufacturers.



2/ Information not verified to be current, no response from manufacturer. Information identical to that published in MIL-HDBK-57, Revision B.

<p>US TOOL & DIE 23282 VERDUGO DR LAGUNA HILLS, CA 92653-1335</p>  <p>CAGE code: 3LJM2 <u>1/</u></p>	<p>VALLEY-TODECO 12975 BRADLEY AVE. SYLMAR, CA 91342</p>  <p>CAGE code: 06710 <u>1/</u></p>
<p>UTAH TOOL & DIE, INC. P.O. BOX 969 850 NO WESTERN PRECISION PARKWAY WEST JORDAN, UTAH 84084</p>  <p>CAGE code: 23509 <u>2/</u></p>	<p>VAN PETTY MFG., INC. DBA J.W. MANUFACTURING INC 2517 AZURITE CIRCLE NEWBURY PARK, CA 91320</p>  <p>CAGE code: 23899 <u>1/</u></p>
<p>VALCOR ENGINEERING CORP. 2 LAWRENCE ROAD SPRINGFIELD, NJ 07081</p>  <p>CAGE code: 96487 <u>2/</u></p>	<p>V-B MACHINE CO., INC. FASTENER DIVISION 1645 W. 135TH STREET GARDENA, CA 90249</p>  <p>CAGE code: 60682 <u>2/</u></p>
<p>VALLEY FORGE AND BOLT MFG CO. 1825 S. 27th AVENUE PHOENIX, AZ 85009-6417</p>  <p>CAGE code: 02UA5 <u>1/</u></p>	<p>VEGAS FASTENER MANUFACTURING 3873 W. OQUENDO ROAD LAS VEGAS, NV 89118</p>  <p>CAGE code: 1U1Z3 <u>2/</u></p>

1/ Information published in this revision was verified by direct contact with manufacturers.

2/ Information not verified to be current, no response from manufacturer. Information identical to that published in MIL-HDBK-57, Revision B.

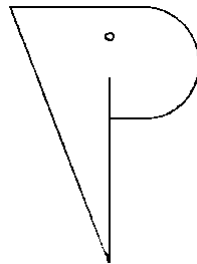

<p>VENUS FASTENERS CORP. 154 MERRICK RD FREEPORT, NY 11520</p>  <p>CAGE code: 045B2 2/</p>
<p>VERSATECH, INC. P.O. BOX 608 6012 ENTERPRISE DR., WESTMORELAND INDUSTRIAL PARK III EXPORT, PA 15632</p>  <p>CAGE code: 0CHD0 2/</p>
<p>VERTEX DISTRIBUTION P. O. BOX 879 327 PINE STREET PAWTUCKET, R 02860</p> <p>(see BELL FASTENERS)</p>  <p>CAGE code: 1/</p>
<p>VICO PRODUCTS, CO. 41555 E. ANN ARBOR ROAD PLYMOUTH, MI 48170</p>  <p>The "V" is either raised or indented.</p> <p>CAGE code: 0CG15 2/</p>

<p>VICTOR PRODUCTS CORP. 2635 WEST BELMONT CHICAGO, IL 60618</p>  <p>CAGE code: 63045 2/</p>
<p>VIP MFG. & ENGR. CORP. 1084 MARTIN AVE. SANTA CLARA, CA 95050</p>  <p>CAGE code: 8M774 1/</p>
<p>VISSERIES & BOULONNERIES DE FOURMIES 2 RUE DU CHAUFFOUR FOURMIES, FRANCE 69610</p>  <p>Grade 8.8 and over</p> <p>CAGE code: F8388 2/</p>

1/ Information published in this revision was verified by direct contact with manufacturers.

2/ Information not verified to be current, no response from manufacturer. Information identical to that published in MIL-HDBK-57, Revision B.

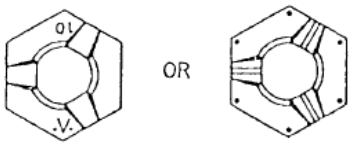
<p>VISTEK INDUSTRIES 153 RAILROAD DR IVYLAND, PA 18974-1448</p>  <p>CAGE code: 79735 2/</p>
<p>VITCO NUCLEAR PRODUCTS INC. 8171 TYLER BLVD MENTOR, OH 44060</p>  <p>CAGE code: 9L424 2/</p>
<p>VM MANUFACTURING CORP. 1536 RAILROAD AVENUE HOLBROOK, NY 11741-2301</p>  <p>CAGE code: 1NUW9 1/</p>

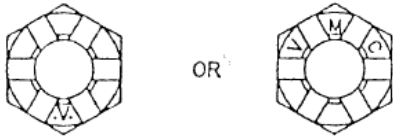
<p>VMC INDUSTRIES, INC. 20 CORPORATE DRIVE AUBURN HILLS, MI 48326</p> <p style="text-align: center;">.V. OR VMC</p> <p style="text-align: center;"><u>FEMALE FASTENERS</u></p> <p style="text-align: center;"><u>PREVAILING TORQUE NUTS</u></p>  <p style="text-align: center;">.V. OR TWO LINES IN THREE PADS WITH APPROPRIATE GRADE OR CLASS MARKINGS</p> <p style="text-align: center;"><u>INSERT TYPE</u></p> <p style="text-align: center;"><u>PREVAILING TORQUE NUTS</u></p>  <p style="text-align: center;">TAN NYLON IDENTIFIES VMC AS MANUFACTURER WITH APPROPRIATE GRADE OR CLASS MARKINGS</p> <p style="text-align: center;"><u>SLOTTED NUTS</u></p>  <p style="text-align: center;">.V. OR VMC WITH APPROPRIATE GRADE OR CLASS MARKINGS</p> <p>CAGE code: 0SFN8</p> <p>Continued 2/</p>

1/ Information published in this revision was verified by direct contact with manufacturers.
2/ Information not verified to be current, no response from manufacturer. Information identical to that published in MIL-HDBK-57, Revision B.

Continued

VMC INDUSTRIES, INC.

FEMALE FASTENERS (CONT.)

NUT & WASHER ASSEMBLY

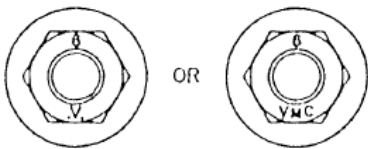

OR

“.V.” OR “VMC” WITH APPROPRIATE GRADE OR CLASS MARKINGS

FLANGE NUTS

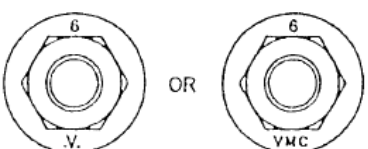

OR

“.V.” OR “VMC” WITH APPROPRIATE GRADE OR CLASS MARKINGS

HEX NUTS

ENGLISH

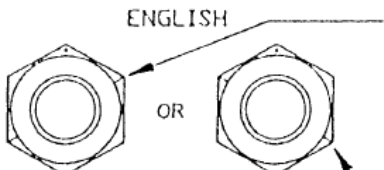

OR

GRADE 5 PER SAE J995
GRADE 8 PER SAE J995

ONE RADIAL LINE FOR MFG. ID., 180° FROM RADIAL LINE IN THE GRADE ID.

METRIC

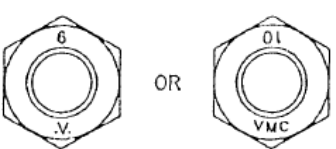

OR

CLASS 9 CLASS 10

“.V.” OR “VMC” WITH APPROPRIATE GRADE OR CLASS MARKINGS

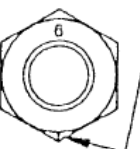

ONE RADIAL LINE 180° FROM APPROPRIATE GRADE OR CLASS MARKINGS

CAGE code: 0SFN8 2/

Continued

Continued

VMC INDUSTRIES, INC.

FEMALE FASTENERS (CONT.)

OTHER TYPE NUTS

WHEEL NUTS, HEX AND SQUARE WELD NUTS AND OTHER TYPE NUTS NOT SPECIFIED.
“.V.” OR “VMC” WITH APPROPRIATE GRADE OR CLASS MARKINGS

MALE FASTENERS

SOCKET HEADS

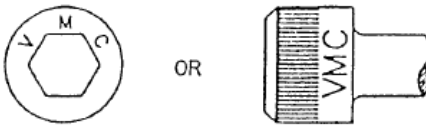

OR

HEX HEADS

INDENTED, TRIMMED, WASHER OR FLANGED.

METRIC

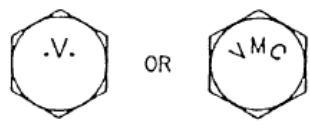

OR

ENGLISH

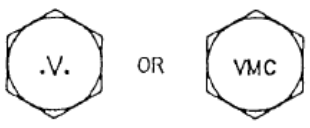

OR

“.V.” OR “VMC” WITH APPROPRIATE GRADE OR CLASS MARKINGS

CAGE code: 0SFN8 2/

1/ Information published in this revision was verified by direct contact with manufacturers.

2/ Information not verified to be current, no response from manufacturer. Information identical to that published in MIL-HDBK-57, Revision B.

VOI-SHAN PRODUCTS
 AFS TORRANCE OPERATIONS
 3000 WEST LOMITA BLVD.
 TORRANCE, CA 90505-5103
 CAGE code: 5M902

VS

AFS COI OPERATIONS
 135 N. UNRUH AVE.
 CITY OF INDUSTRY, CA 91744
 CAGE code: 06950, IRC86

VS O SC

AFS HILDESHEIM OPERATIONS
 STEVEN 3
 31135 HILDESHEIM-BEVENSTEDT,
 GERMANY
 CAGE code: C4293

VS

(Corporate office see ALCOA FASTENING SYSTEMS)

CAGE code: 5M902, 06950, IRC86, C4293 1/

VOSS INDUSTRIES, INC.
 VOSS AEROSPACE DIVISION
 2168 WEST 25TH STREET
 CLEVELAND, OH 44113

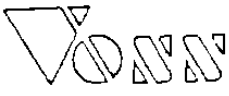

E A

V

CAGE code: 14242 1/

VSI
 AEROSPACE PRODUCTS DIVISION
 557 S. DOUGLAS ST.
 EL SEGUNDO, CA 90245

Plant
 VOI-SHAN DIVISION
 4001 INGLEWOOD AVE.
 REDONDO BEACH, CA 90278

VS

CAGE code: 6A768 2/

VULCAN RIVET & BOLT CORP.
 P.O. BOX 170129
 BIRMINGHAM, AL 35217

V.

All fasteners marked with the letter "V" followed by a period (.)

V.

Fasteners manufactured from special alloy steels are identified with the letter "V" followed by a period (.) and a line under the letter "V"

304

V.

Stainless steel fasteners are marked with the letter "V" followed by a period (.) with the type of stainless

CAGE code: 0GEW3 2/







WALKER BOLT MANUFACTURING CO., INC.
 DIVISION OF LONE STAR FASTENERS, LP
 P.O. BOX 1149
 10202 AIRLINE CRIVE
 HOUSTON, TX 77037

WB

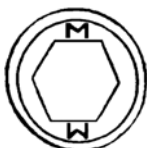
CAGE code: 39782 1/

1/ Information published in this revision was verified by direct contact with manufacturers.

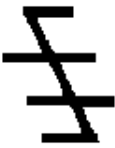
2/ Information not verified to be current, no response from manufacturer. Information identical to that published in MIL-HDBK-57, Revision B.

<p>WALZ & KRENZER INC DBA MAPECO PRODUCTS DIV MAPECO PRODUCTS 91 WILLENBROCK RD STE B4 OXFORD, CT 06478-1036</p>  <p>CAGE code: 87045 <u>2/</u></p>	<p>WEAVER MANUFACTURING, INC. 1005 E. 17TH STREET WICHITA, KS 67214</p>  <p>CAGE code: 16345 <u>2/</u></p>
<p>WARREN PUMPS LLC. (DIVISION OF COLFAX CORPORATION) P.O. BOX 969 82 BRIDGES AVENUE WARREN, MA 01083</p>  <p>CAGE code: 63857 <u>1/</u></p>	<p>WEBLUK MACHINE CORP. 4959 COMMERCE PARKWAY WARRENSVILLE HEIGHTS, OH 44128</p>  <p>CAGE code: 0C095 <u>2/</u></p>
<p>WATERBURY BUCKLE CO. 952 S. MAIN STREET WATERBURY, CT 06721</p>  <p>CAGE code: 82399 <u>2/</u></p>	<p>WELTER GMBH & CO. KG BONNER RING 49 P. O. BOX 1311 ERFTSTADT, GERMANY 50374</p>  <p>CAGE code: C3486 <u>2/</u></p>
<p>WAYNE BOLT & NUT CO., INC. 14471 LIVERNOIS AVE. DETROIT, MI 48238-2097</p>  <p>CAGE code: 5Z751 <u>1/</u></p>	<p>WELTON ROLLED THREAD CORP. 1818 GLENDALE BLVD LOS ANGELES, CA 90026</p>  <p>CAGE code: 27871 <u>2/</u></p>

1/ Information published in this revision was verified by direct contact with manufacturers.

2/ Information not verified to be current, no response from manufacturer. Information identical to that published in MIL-HDBK-57, Revision B.

WESLOK
(DIVISION OF FALL RIVER
MANUFACTURING)
4160 S. 13TH STREET
MILWAUKEE, WI 53221

WESLOK

CAGE code: 2/

WEST COAST AEROSPACE, INC.
24224 BROAD STREET
CARSON, CA 90745

Plant
220 WEST E. STREET
WILMINGTON, CA 90744

WC
WC

CAGE code: 60516 1/

WEST TENNESEE LIONS BLIND IND. INC.
P.O. BOX 2175
346 ST PAUL AVENUE
MEMPHIS, TN 38101-2175

(See A P MILLS INDUSTRIES FOR THE BLIND)

APMI

CAGE code: 6Y776 2/

WESTERN PACIFIC ENTERPRISES, W.P.E.
INC.
8110 REMMET AVE.
CANOGA PARK, CA 91304



CAGE code: 5N444 1/

WESTERN SCREW MACHINE PRODUCTS,
INC. (CUTTING EDGE MACHINING)
1625 LINDA WAY
SPARKS, NV 89431

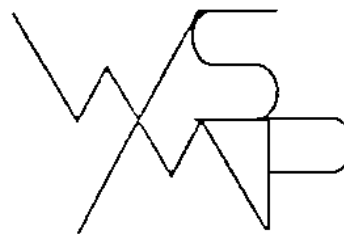

CAGE code: OZV72 2/





WESTERN SKY INDUSTRIES, INC.
(DIVISION OF ATLAS CORP.)
21300 CLOUDWAY
HAYWARD, CA 94545



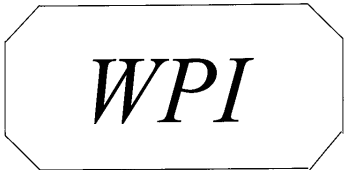

WSI

CAGE code: 04169 2/

1/ Information published in this revision was verified by direct contact with manufacturers.

2/ Information not verified to be current, no response from manufacturer. Information identical to that published in MIL-HDBK-57, Revision B.

<p>WESTFIELD FASTENERS 202 UNION STREET WESTFIELD, MA 01085</p>  <p>CAGE code: <u>1/</u></p>
<p>WESTLAND STEEL PRODUCTS, LTD. P. O. BOX 1052 165 CORDITE ROAD WINNIPEG, MANITOBA, CANADA R3C 2X4</p>  <p>CAGE code: 0NWY5 <u>2/</u></p>
<p>WESTWOOD PRECISION, INC. 7509 HARDESON ROAD EVERETT, WA 98203</p>  <p>CAGE code: 0PL34 <u>1/</u></p>
<p>WHAIL BOLT IND. CO., LTD 779-2, WONSI-DONG, ANSAN KYUGKI-DO, KOREA</p>  <p>GRADE 5 HEX CAP SCREWS GRADE 8 HEX CAP SCREWS</p> <p>CAGE code: <u>2/</u></p>

<p>WHELAN MACHINE & TOOL CO. 134 ROCHESTER DR LOUISVILLE, KY 40214-2681</p>  <p><small>Aerial-Bold letter "W" enclosed with a circle</small></p> <p>CAGE code: 0MB07 <u>1/</u></p>
<p>WHITNEY SCREW CORP. P.O. BOX 784 14A BROAD STREET NASHUA, NH 03061</p>  <p>CAGE code: 87181 <u>2/</u></p>
<p>WHITTET-HIGGINS CO. 33 HIGGINSON AVE. CENTRAL FALLS, RI 02863</p>  <p>CAGE code: 79568 <u>2/</u></p>
<p>WIGLEY MACHINE COMPANY 2007 WEST 2ND AVENUE CORSICANA, TX 75110</p>  <p>CAGE code: 0UBT5 <u>2/</u></p>

1/ Information published in this revision was verified by direct contact with manufacturers.
2/ Information not verified to be current, no response from manufacturer. Information identical to that published in MIL-HDBK-57, Revision B.

WILHELM SCHUMACHER SCHRAUBEN-FABRIK GmbH
 POSTFACH 12 80,
 AM PREIST 5
 D-5912 HILCHENBACH,
 GERMANY



Hex head screws and bolts



Machine screws and other products

CAGE code: 2/

WILSON-GARNER CO.
 40935 PRODUCTION DR
 HARRISON TOWNSHIP, MI 48045-1351

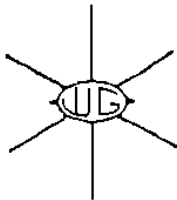
CAGE code: 7E548 1/

WILLIAM'S MACHINE & FABRICATION, INC.
 P.O. BOX 22235
 700 DELAY DRIVE
 EUGENE, OR 97402

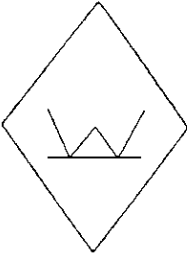

CAGE code: 0NNK2 2/

WILT PRECISION PRODUCTS
 P.O. BOX 69
 DOVER, PA 17315



CAGE code: 34282 2/

WIL-NIC
 (E D R INDUSTRIES INC)
 DBA WIL-NICO
 100 COMMERCIAL STREET
 FREEPORT, NY 11520-2832



CAGE code: 8P827 2/

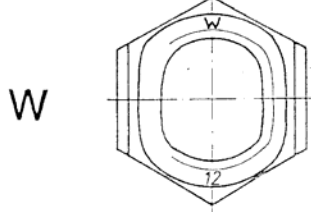

WINKER HERMAN GMBH & CO. KG
 METALLWARENFABRIK
 P.O. BOC 1356
 DELLINGER WEG 1
 SPAICHINGEN, 78549
 GERMANY



CAGE code: D2362 2/

1/ Information published in this revision was verified by direct contact with manufacturers.

2/ Information not verified to be current, no response from manufacturer. Information identical to that published in MIL-HDBK-57, Revision B.

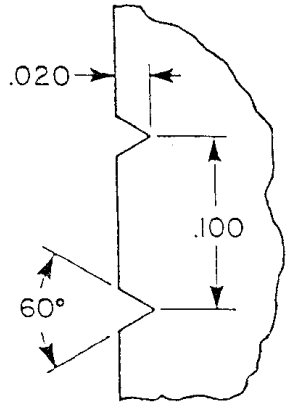

<p>WINSLOW AUTOMATICS, INC. 23 ST. CLAIR AVENUE NEW BRITAIN, CT 06051</p>  <p>CAGE code: 7W515 <u>1/</u></p>
<p>WODIN, INC. 5441 PERKINS ROAD BEDFORD HEIGHTS, OH 44146</p>  <p>CAGE code: 5V334 <u>1/</u></p>
<p>WOLSTENHOLME MACHINE (DBA WM ROBOTS) 3075 ADVANCE LANE COLMAR, PA 18915-9420</p>  <p>CAGE code: 68531 <u>1/</u></p>

<p>WOLTERS GMBH OTTILIENSTR 19 D-GUTERSLOH WEST GERMANY</p>  <p>CAGE code: <u>2/</u></p>
<p>WOLVERINE MACHINE PRODUCTS CO. P.O. BOX 209 319 COGSHALL ST. HOLLY, MI 48442</p>  <p>CAGE code: 2T549 <u>2/</u></p>

1/ Information published in this revision was verified by direct contact with manufacturers.

2/ Information not verified to be current, no response from manufacturer. Information identical to that published in MIL-HDBK-57, Revision B.

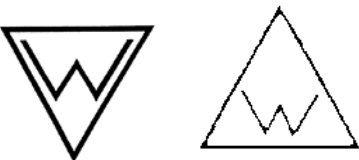

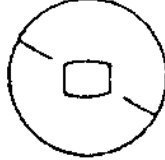
<p>WOLVERINE NUT CO. 6556 EAST McNICHOLS DETROIT, MI 48212</p>  <p>3 dots, centered on corner, equally spaced</p> <p>CAGE code: 87824 2/</p>
<p>WORTHEY MACHINE P. O. BOX 70 3000 US HWY 72 E PAINT ROCK, AL 35764-0070</p> <p style="text-align: center;">WSMP</p> <p>CAGE code: 5S740 2/</p>
<p>WROUGHT WASHER MANUFACTURING INC. 2100 SOUTH BAY STREET MILWAUKEE, WI 53207</p>  <p>Marking for medium carbon heat treated washers compatible with Grade 5 and Grade 8 bolts.</p>  <p>Marking for low carbon washers.</p> <p>CAGE code: 79807 2/</p>

<p>WYANDOTTE INDUSTRIES, INC. 4625 13TH STREET WYANDOTTE, MI 48192</p>  <p>CAGE code: 54151 1/</p>
<p>WYNNSON ENTERPRISES, INC. P. O. BOX 440 12039 HWY 239-431 N. MERIDIANVILLE, AL 35759-1201</p>  <p>CAGE code: 39484 1/</p>
<p>XCEL MFG., INC. P.O. BOX 239 ELYRIA, OH 44036</p>  <p>CAGE code: 2/</p>
<p>Y2K MACHINE SHOP 106 WALSH ROAD SAN ANTONIO, TX 78224</p> <p style="text-align: center;">Y 2 K</p> <p>CAGE code: 1TMD7 1/</p>

1/ Information published in this revision was verified by direct contact with manufacturers.

2/ Information not verified to be current, no response from manufacturer. Information identical to that published in MIL-HDBK-57, Revision B.

<p>YATES TOOL, INC. 2425 MEDINA ROAD MEDINA, OH 44256</p>  <p>Either electroetched, steel stamped, vibropeened, or ink stamped</p> <p>CAGE code: IDV02 2/</p>
<p>YOUNG ENGINEERS INC, THE 25841 COMMERCENTRE DRIVE LAKE FOREST, CA 92630-8812</p> <p style="font-size: 2em; text-align: center;">TYE</p> <p>CAGE code: 56958 1/</p>
<p>YOW MENG I INDUSTRIAL CO., LTD. NO. 180 WUN-AN RD., EAST SEC. MI-TUO HSIANG 82704 KAOHSIUNG HSIEN, TAIWAN, R.O.C.</p>  <p>CAGE code: 2/</p>
<p>Z & B GENERAL MACHINE 569 HULMEVILLE AVE. PENNDL, PA 19047</p>  <p>CAGE code: 5T735 2/</p>

<p>ZAMON CO., INC. ENDICOTT ST., BLDG. 23 NORWOOD, MA 02062</p>  <p>CAGE code: 5Z471 2/</p>
<p>ZENEX CORPORATION 850 ELMHURST RD. ELK GROVE VILLAGE, IL 60007</p> <p style="font-size: 2em; text-align: center;">ZENEX</p> <p>CAGE code: 25723 2/</p>
<p>ZERO PRODUCTS, INC. 219 BAYWOOD ST HOUSTON, TEXAS 77011</p>  <p style="font-size: 2em; text-align: center;">Z</p> <p>CAGE code: 3JC57 2/</p>

1/ Information published in this revision was verified by direct contact with manufacturers.

2/ Information not verified to be current, no response from manufacturer. Information identical to that published in MIL-HDBK-57, Revision B.

MIL-HDBK-57 FASTENER IDENTIFICATION SYMBOL CONFIRMATION

Complete this form and email to alonzo.miller@dla.mil, along with a separate PDF file containing artwork of your fastener head marking.

(Company name as it will appear in the listing) _____

(Department, Division, etc., if it is to appear in the listing)

Corporate/Mailing Address	Plant Location (if different)
_____	_____
_____	_____
_____	_____
_____	_____

Our Company is a fastener manufacturer YES () NO ()

NOTE: MIL-HDBK-57 requires the sources listed to have an inherent capability to manufacture fasteners out of raw material.

Telephone: _____ FAX Number: _____

Contact Name: _____ CAGE code: _____

Title: _____ DUNS Number: _____

Email: _____ Website URL: _____

1. Fastener head marking artwork that is submitted electronically shall be provided in a PDF file. A resolution of 100 dpi (dots per inch) minimum shall be used for artwork that is scanned. Provide only one marking per file submitted. Include the company name and plant location in this file, along with a written description of the fastener head marking. (For example “the script upper case letter A”, or “the number 3 enclosed by a circle.”)
2. If your company has plants in various locations, please provide DSCP-NASA with the symbol(s) used for each location, as well as the CAGE code, point of contact, and phone number for each point of contact.
3. All information must be supplied in the English language.
4. Submit this form and artwork to alonzo.miller@dla.mil

NOTE: We encourage you to duplicate this form and forward it to your various plants, as necessary.

SUBMITTED BY: _____

TITLE: _____

DATE (mm/dd /yyyy): _____

PLEASE SUBMIT LOGO (HEAD MARKING) ON A SEPARATE SHEET.

Subject term (key word) listing:

Fastener
Head marking
Logo
Symbol

Changes from previous issue. Marginal notations are not used in this revision to identify changes with respect to the previous issue due to the extent of the changes.

Preparing Activity:
DLA-IS

(Project No. 53GP-2009-001)

NOTE: The activities listed above were interested in this document as of the date of this document. Since organizations and responsibilities can change, you should verify the currency of the information above using the ASSIST Online database at <http://assist.daps.dla.mil>.